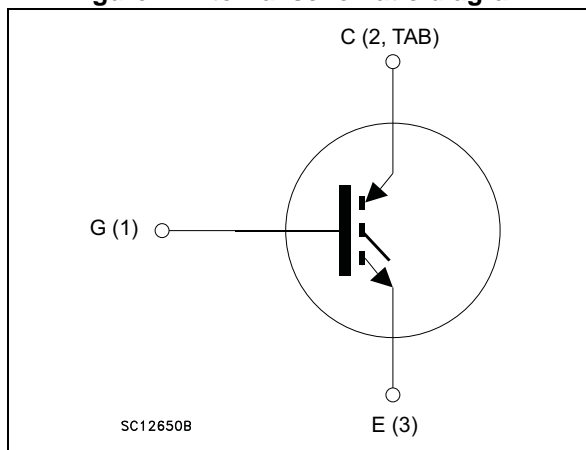

Figure 1. Internal schematic diagram



### Features

- Maximum junction temperature:  $T_J = 175\text{ °C}$
- Very high speed switching series
- Tail-less switching off
- Low saturation voltage:  $V_{CE(sat)} = 1.8\text{ V (typ.)}$  @  $I_C = 20\text{ A}$
- Tight parameters distribution
- Safe paralleling
- Low thermal resistance
- Lead free package

### Applications

- Photovoltaic inverters
- Uninterruptible power supply
- Welding
- Power factor correction
- Very high frequency converters

### Description

This device is an IGBT developed using an advanced proprietary trench gate and field stop structure. The device is part of the "V" series of IGBTs, which represent an optimum compromise between conduction and switching losses to maximize the efficiency of very high frequency converters. Furthermore, a positive  $V_{CE(sat)}$  temperature coefficient and very tight parameter distribution result in safer paralleling operation.

Table 1. Device summary

Order code	Marking	Package	Packaging
STGFW20V60F	GFW20V60F	TO-3PF	Tube
STGW20V60F	GW20V60F	TO-247	Tube
STGWT20V60F	GWT20V60F	TO-3P	Tube

# Contents

<b>1</b>	<b>Electrical ratings</b> .....	<b>3</b>
<b>2</b>	<b>Electrical characteristics</b> .....	<b>4</b>
	2.1 Electrical characteristics (curves) .....	6
<b>3</b>	<b>Test circuits</b> .....	<b>11</b>
<b>4</b>	<b>Package mechanical data</b> .....	<b>12</b>
<b>5</b>	<b>Revision history</b> .....	<b>18</b>

# 1 Electrical ratings

**Table 2. Absolute maximum ratings**

Symbol	Parameter	Value			Unit
		TO-3PF	TO-247	TO-3P	
$V_{CES}$	Collector-emitter voltage ( $V_{GE} = 0$ )	600			V
$I_C$	Continuous collector current at $T_C = 25\text{ °C}$	40 <sup>(1)</sup>	40		A
$I_C$	Continuous collector current at $T_C = 100\text{ °C}$	20 <sup>(1)</sup>	20		A
$I_{CP}^{(2)}$	Pulsed collector current	80 <sup>(1)</sup>	80		A
$V_{GE}$	Gate-emitter voltage	±20			V
$P_{TOT}$	Total dissipation at $T_C = 25\text{ °C}$	52	167		W
$V_{ISO}$	Insulation withstand voltage (RMS) from all three leads to external heat sink ( $t = 1\text{ s}$ ; $T_c = 25\text{ °C}$ )	3.5			kV
$T_{STG}$	Storage temperature range	- 55 to 150			°C
$T_J$	Operating junction temperature	- 55 to 175			°C

1. Limited by maximum junction temperature.
2. Pulse width limited by maximum junction temperature

**Table 3. Thermal data**

Symbol	Parameter	Value			Unit
		TO-3PF	TO-247	TO-3P	
$R_{thJC}$	Thermal resistance junction-case	2.9	0.9		°C/W
$R_{thJA}$	Thermal resistance junction-ambient	50			°C/W

## 2 Electrical characteristics

T<sub>J</sub> = 25 °C unless otherwise specified.

**Table 4. Static characteristics**

Symbol	Parameter	Test conditions	Min.	Typ.	Max.	Unit
V <sub>(BR)CES</sub>	Collector-emitter breakdown voltage (V <sub>GE</sub> = 0)	I <sub>C</sub> = 2 mA	600			V
V <sub>CE(sat)</sub>	Collector-emitter saturation voltage	V <sub>GE</sub> = 15 V, I <sub>C</sub> = 20 A		1.8	2.2	V
		V <sub>GE</sub> = 15 V, I <sub>C</sub> = 20 A T <sub>J</sub> = 125 °C		2.15		
		V <sub>GE</sub> = 15 V, I <sub>C</sub> = 20 A T <sub>J</sub> = 175 °C		2.3		
V <sub>GE(th)</sub>	Gate threshold voltage	V <sub>CE</sub> = V <sub>GE</sub> , I <sub>C</sub> = 1 mA	5	6	7	V
I <sub>CES</sub>	Collector cut-off current (V <sub>GE</sub> = 0)	V <sub>CE</sub> = 600 V			25	μA
I <sub>GES</sub>	Gate-emitter leakage current (V <sub>CE</sub> = 0)	V <sub>GE</sub> = ± 20 V			250	nA

**Table 5. Dynamic characteristics**

Symbol	Parameter	Test conditions	Min.	Typ.	Max.	Unit
C <sub>ies</sub>	Input capacitance	V <sub>CE</sub> = 25 V, f = 1 MHz, V <sub>GE</sub> = 0	-	2800	-	pF
C <sub>oes</sub>	Output capacitance		-	110	-	pF
C <sub>res</sub>	Reverse transfer capacitance		-	64	-	pF
Q <sub>g</sub>	Total gate charge	V <sub>CC</sub> = 480 V, I <sub>C</sub> = 20 A, V <sub>GE</sub> = 15 V, see <a href="#">Figure 26</a>	-	116	-	nC
Q <sub>ge</sub>	Gate-emitter charge		-	24	-	nC
Q <sub>gc</sub>	Gate-collector charge		-	50	-	nC

Table 6. Switching characteristics (inductive load)

Symbol	Parameter	Test conditions	Min.	Typ.	Max.	Unit
$t_{d(on)}$	Turn-on delay time	$V_{CE} = 400\text{ V}$ , $I_C = 20\text{ A}$ , $V_{GE} = 15\text{ V}$ , $di/dt = 100\text{ A}/\mu\text{s}$ see <a href="#">Figure 25</a>	-	38	-	ns
$t_r$	Current rise time		-	10	-	ns
$(di/dt)_{on}$	Turn-on current slope		-	1556	-	$A/\mu\text{s}$
$t_{d(off)}$	Turn-off delay time		-	149	-	ns
$t_f$	Current fall time		-	15	-	ns
$E_{on}^{(1)}$	Turn-on switching losses		-	200	-	$\mu\text{J}$
$E_{off}^{(2)}$	Turn-off switching losses		-	130	-	$\mu\text{J}$
$E_{ts}$	Total switching losses		-	330	-	$\mu\text{J}$
$t_{d(on)}$	Turn-on delay time	$V_{CE} = 400\text{ V}$ , $I_C = 20\text{ A}$ , $di/dt = 100\text{ A}/\mu\text{s}$ , $V_{GE} = 15\text{ V}$ , $T_J = 175\text{ }^\circ\text{C}$ , see <a href="#">Figure 25</a>	-	37	-	ns
$t_r$	Current rise time		-	12	-	ns
$(di/dt)_{on}$	Turn-on current slope		-	1340	-	$A/\mu\text{s}$
$t_{d(off)}$	Turn-off delay time		-	150	-	ns
$t_f$	Current fall time		-	23	-	ns
$E_{on}^{(1)}$	Turn-on switching losses		-	430	-	$\mu\text{J}$
$E_{off}^{(2)}$	Turn-off switching losses		-	210	-	$\mu\text{J}$
$E_{ts}$	Total switching losses		-	640	-	$\mu\text{J}$

1. Energy losses include reverse recovery of the external diode. The diode is the same of the copacked STGW20V60DF
2. Turn-off losses include also the tail of the collector current.

## 2.1 Electrical characteristics (curves)

Figure 2. Power dissipation vs. case temperature for TO-247 and TO-3P

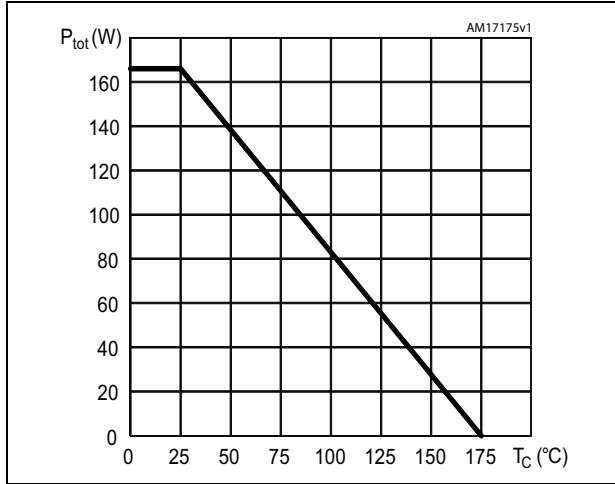

Figure 3. Collector current vs. case temperature for TO-247 and TO-3P

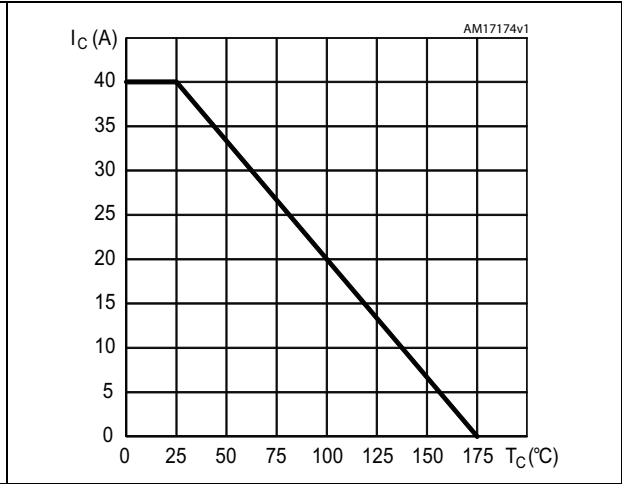

Figure 4. Power dissipation vs. case temperature for TO-3PF

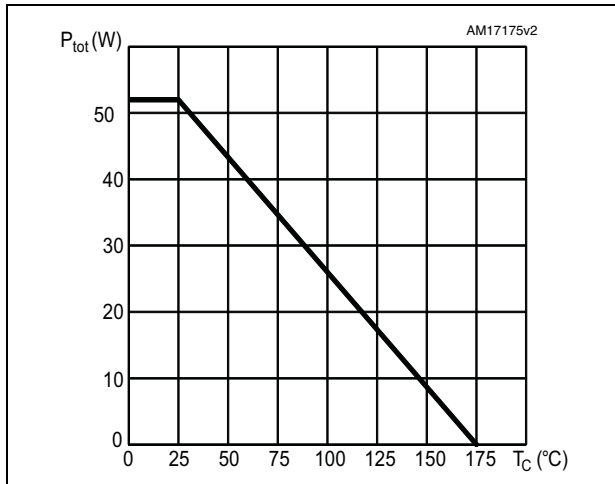

Figure 5. Collector current vs. case temperature for TO-3PF

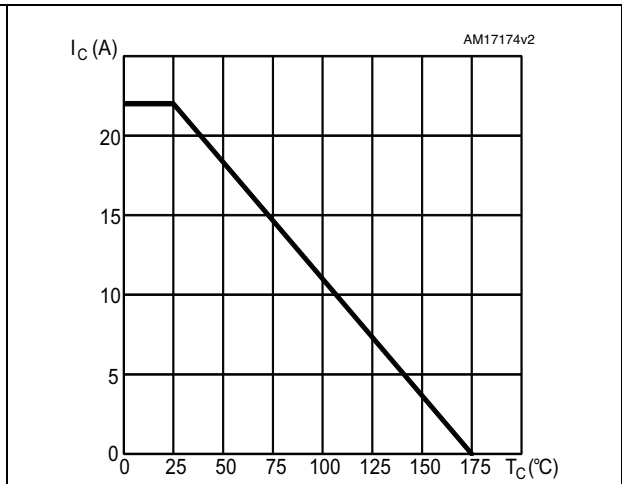

Figure 6. Output characteristics ( $T_J = 25\text{ }^\circ\text{C}$ )

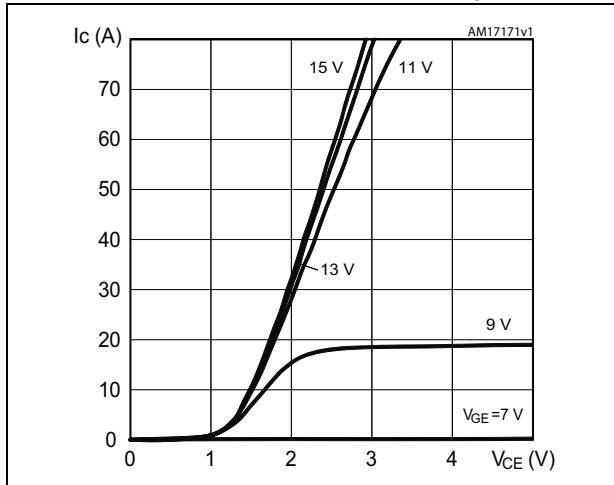

Figure 7. Output characteristics ( $T_J = 175\text{ }^\circ\text{C}$ )

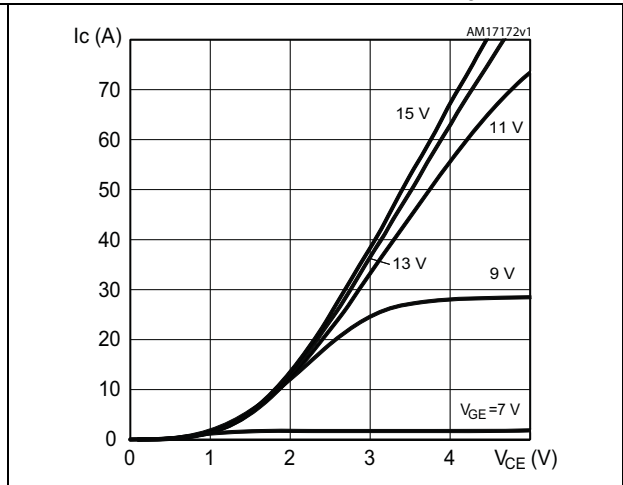

Figure 8.  $V_{CE(SAT)}$  vs. junction temperature

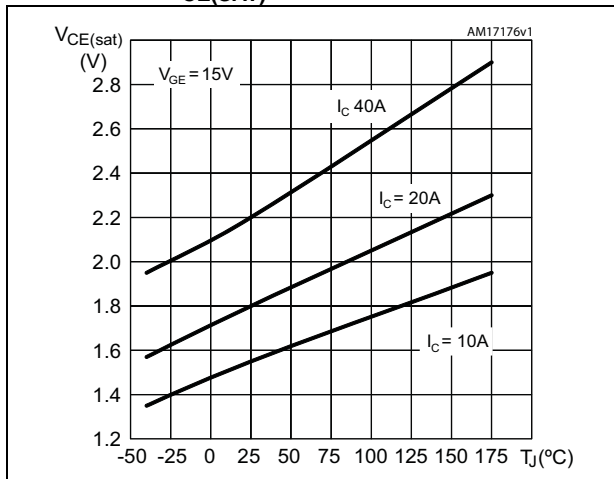

Figure 9.  $V_{CE(SAT)}$  vs. collector current

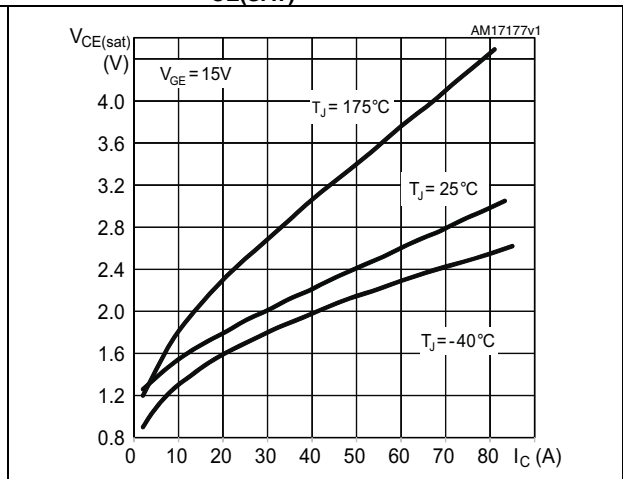

Figure 10. Safe operating area for TO-247 and TO-3P

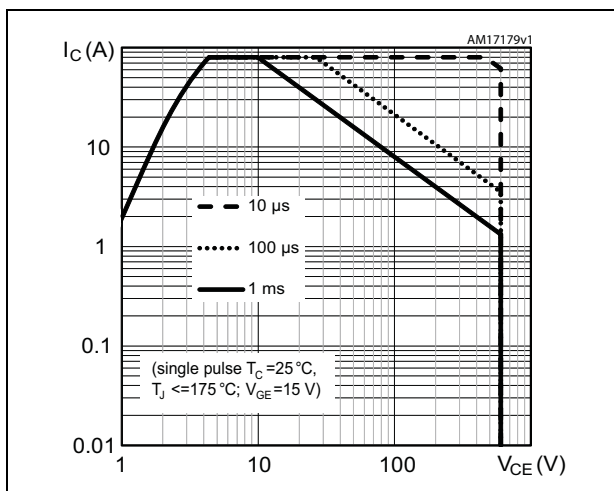

Figure 11. Safe operating area for TO-3PF

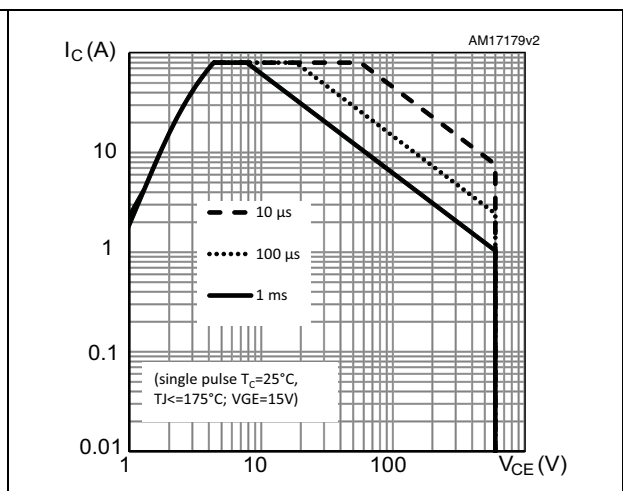

Figure 12. Normalized  $V_{GE(th)}$  vs. junction temperature

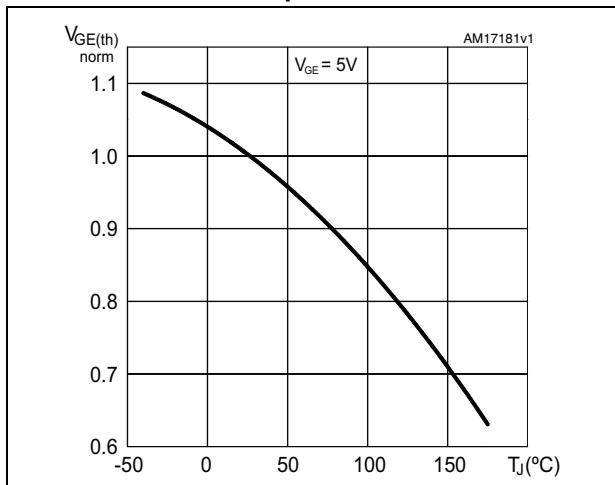

Figure 13. Normalized  $V_{(BR)CES}$  vs. junction temperature

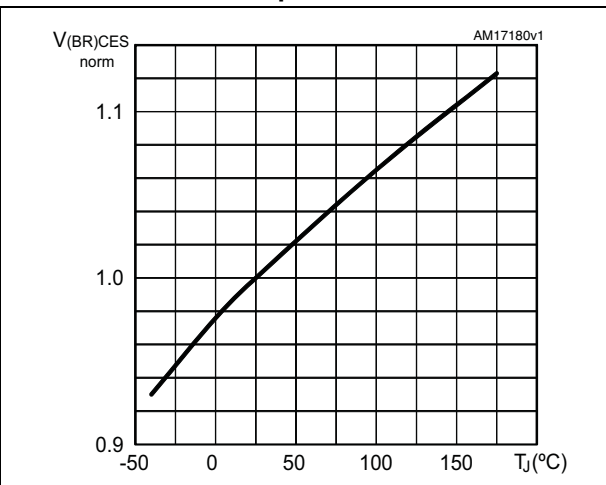

Figure 14. Capacitance variations

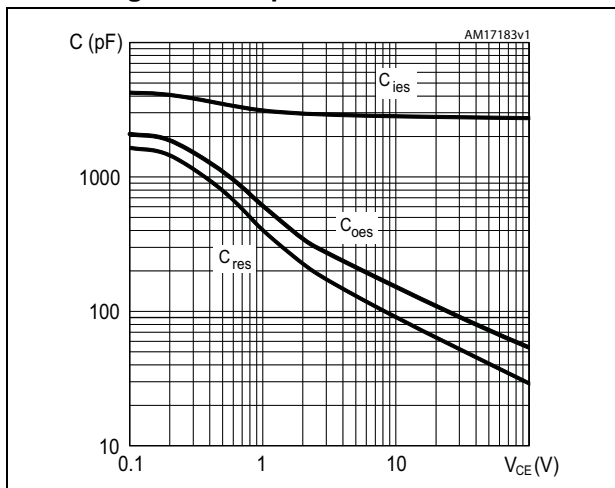

Figure 15. Gate charge vs. gate-emitter voltage

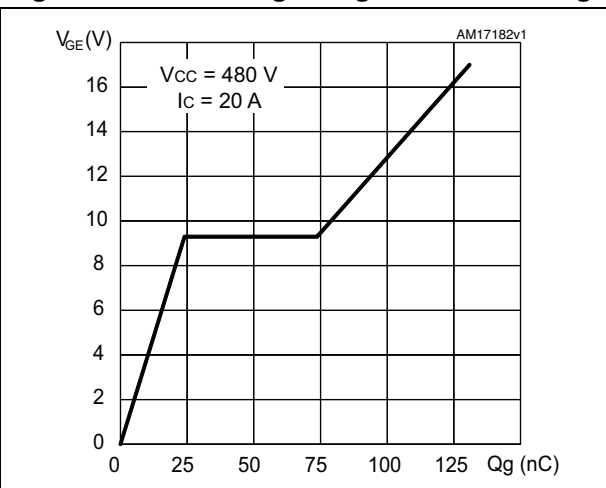

Figure 16. Switching losses vs. collector current

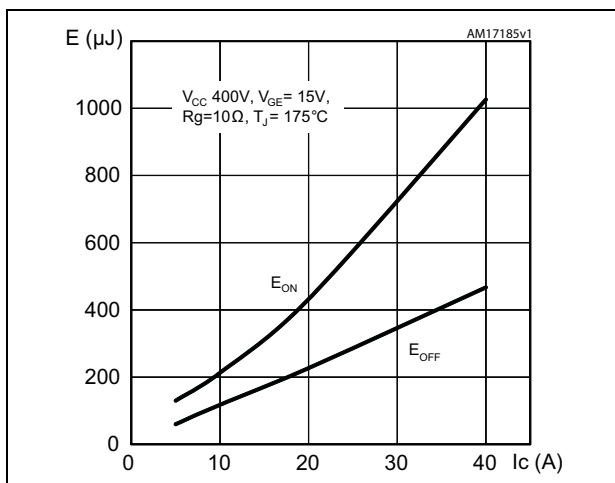

Figure 17. Switching losses vs. gate resistance

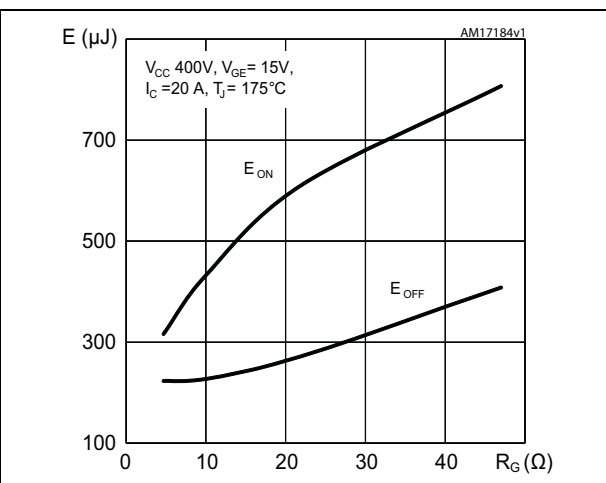



Figure 18. Switching losses vs. junction temperature

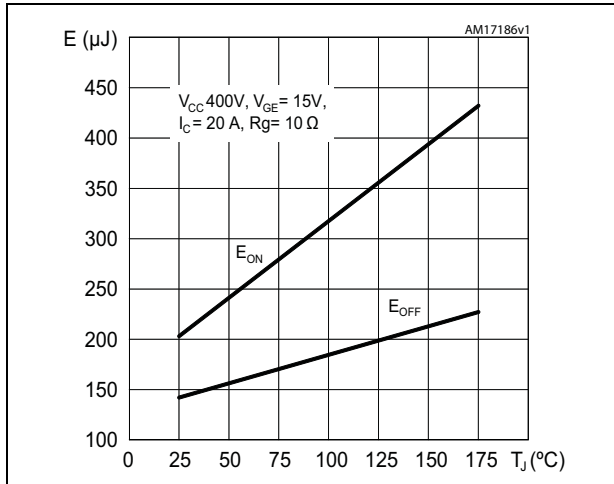

Figure 19. Switching losses vs. collector emitter voltage

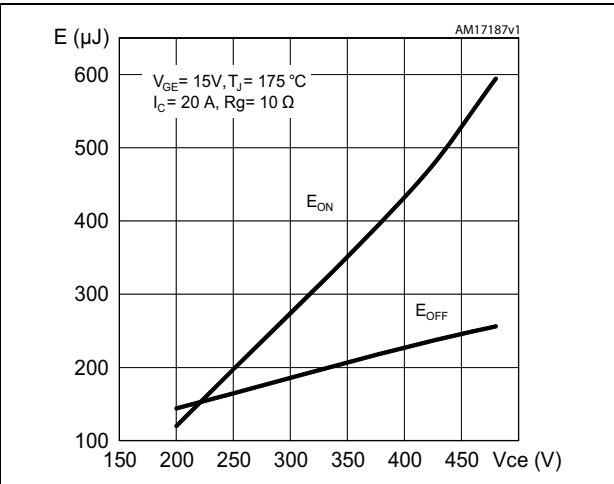

Figure 20. Switching times vs. collector current

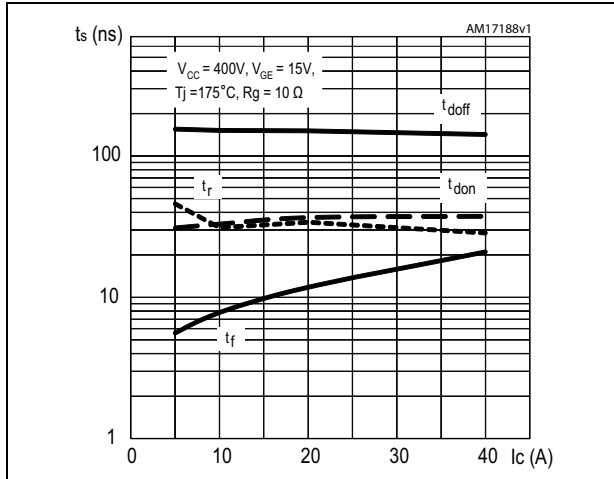

Figure 21. Switching times vs. gate resistance

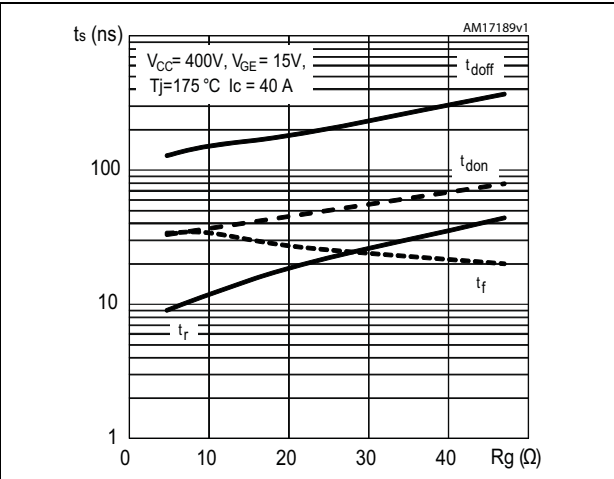

Figure 22. Transfer characteristics

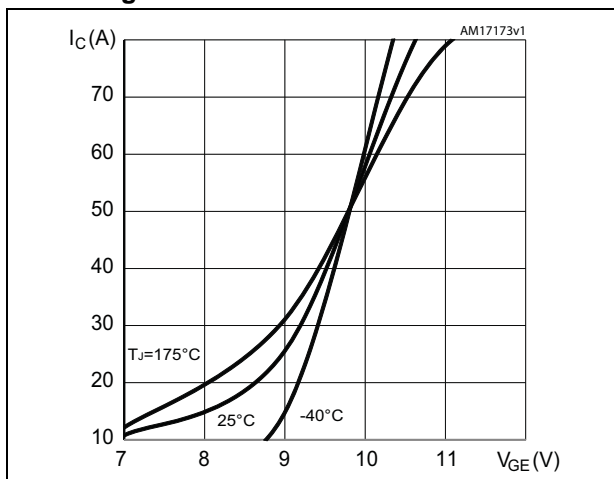

Figure 23. Thermal data for TO-3PF

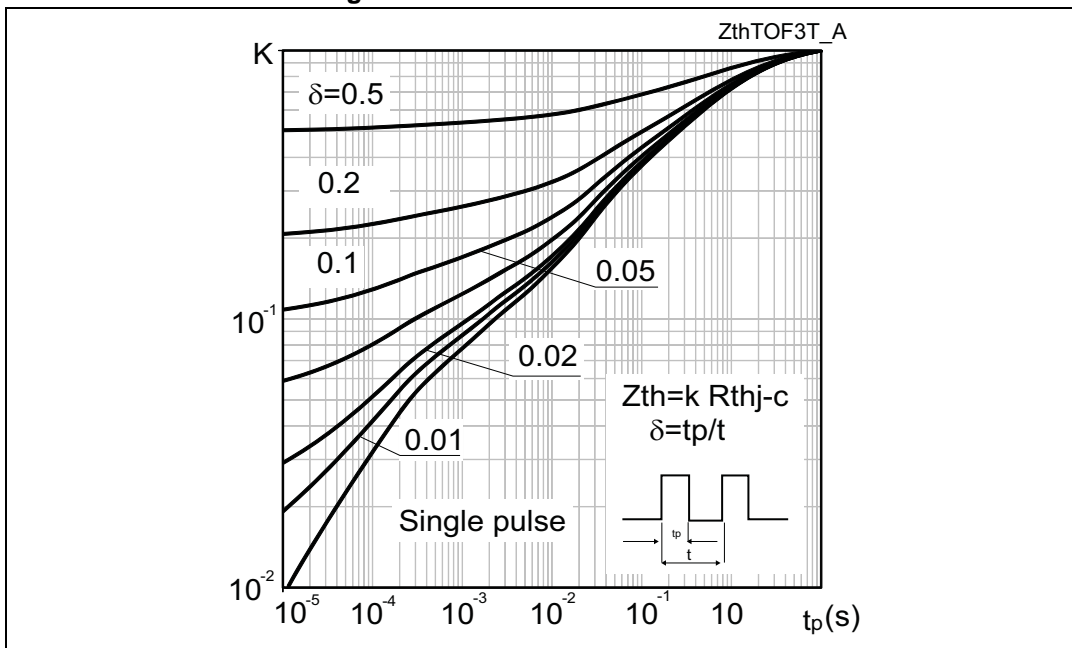
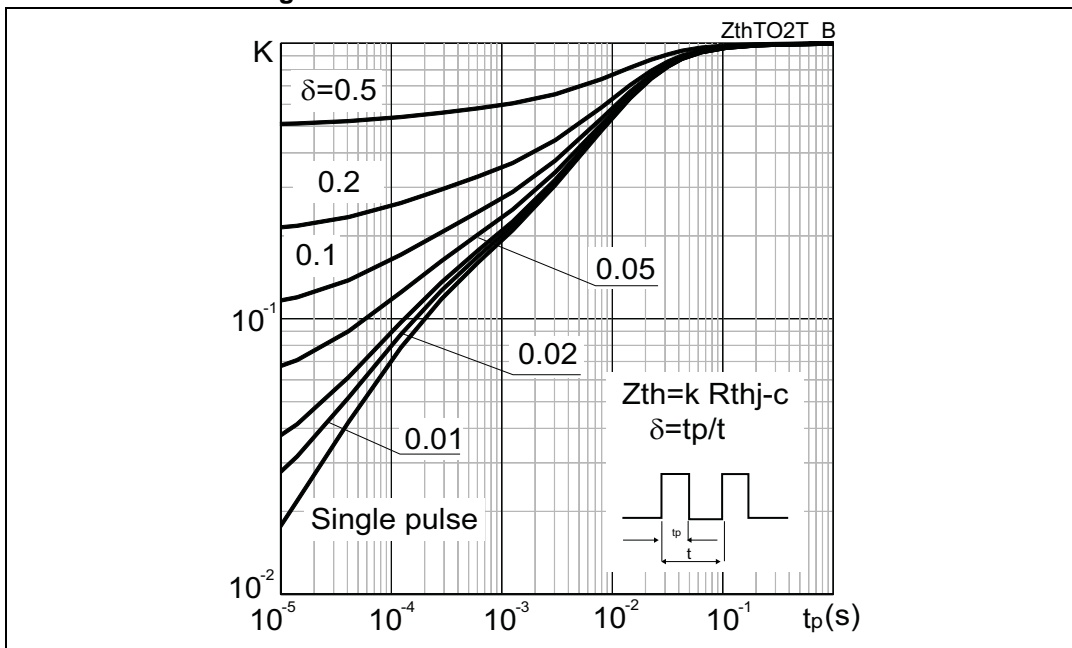

Figure 24. Thermal data for TO-3P and TO-247



### 3 Test circuits

Figure 25. Test circuit for inductive load switching



Figure 26. Gate charge test circuit

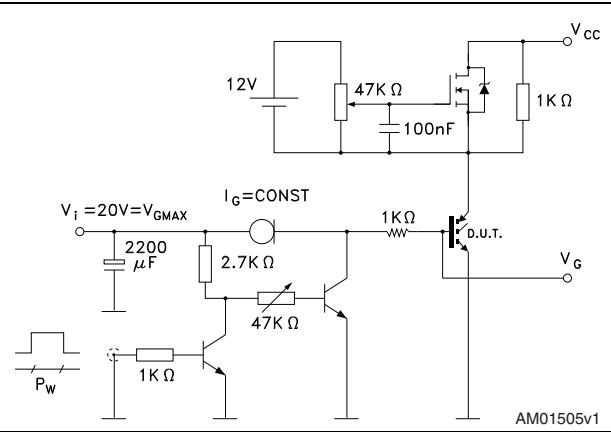
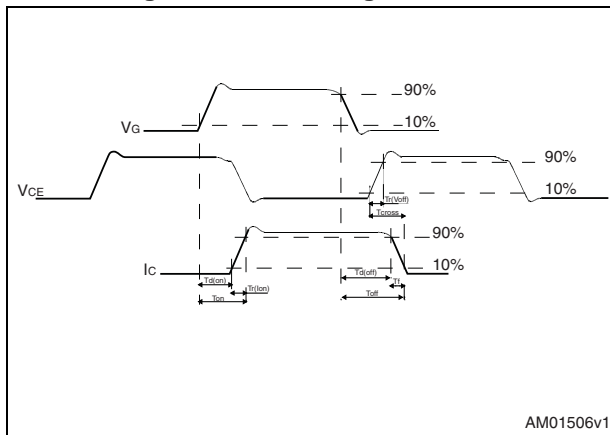

Figure 27. Switching waveform



## 4 Package mechanical data

In order to meet environmental requirements, ST offers these devices in different grades of ECOPACK<sup>®</sup> packages, depending on their level of environmental compliance. ECOPACK<sup>®</sup> specifications, grade definitions and product status are available at: [www.st.com](http://www.st.com). ECOPACK is an ST trademark.

**Table 7. TO-3PF mechanical data**

Dim.	mm		
	Min.	Typ.	Max.
A	5.30		5.70
C	2.80		3.20
D	3.10		3.50
D1	1.80		2.20
E	0.80		1.10
F	0.65		0.95
F2	1.80		2.20
G	10.30		11.50
G1		5.45	
H	15.30		15.70
L	9.80	10	10.20
L2	22.80		23.20
L3	26.30		26.70
L4	43.20		44.40
L5	4.30		4.70
L6	24.30		24.70
L7	14.60		15
N	1.80		2.20
R	3.80		4.20
Dia	3.40		3.80

Figure 28. TO-3PF drawing

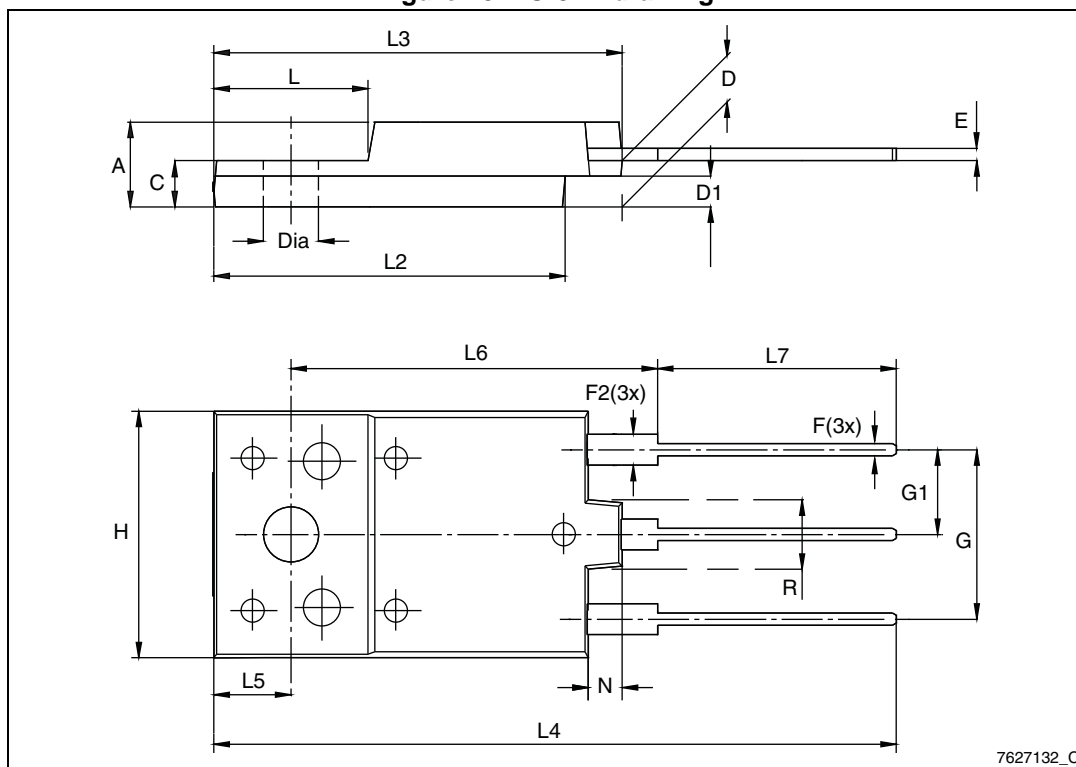

7627132\_C

Table 8. TO-247 mechanical data

Dim.	mm.		
	Min.	Typ.	Max.
A	4.85		5.15
A1	2.20		2.60
b	1.0		1.40
b1	2.0		2.40
b2	3.0		3.40
c	0.40		0.80
D	19.85		20.15
E	15.45		15.75
e	5.30	5.45	5.60
L	14.20		14.80
L1	3.70		4.30
L2		18.50	
ØP	3.55		3.65
ØR	4.50		5.50
S	5.30	5.50	5.70

Figure 29. TO-247 drawing

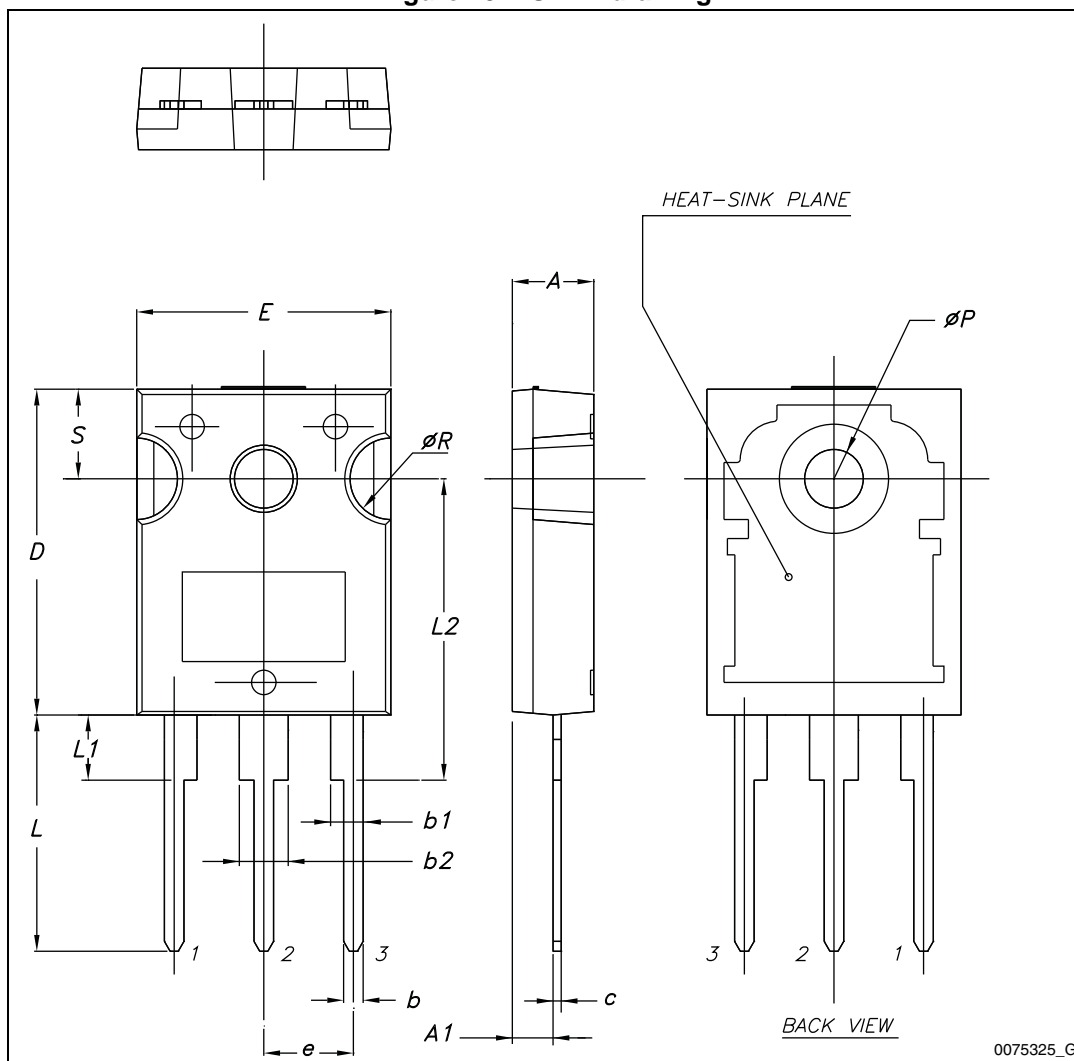
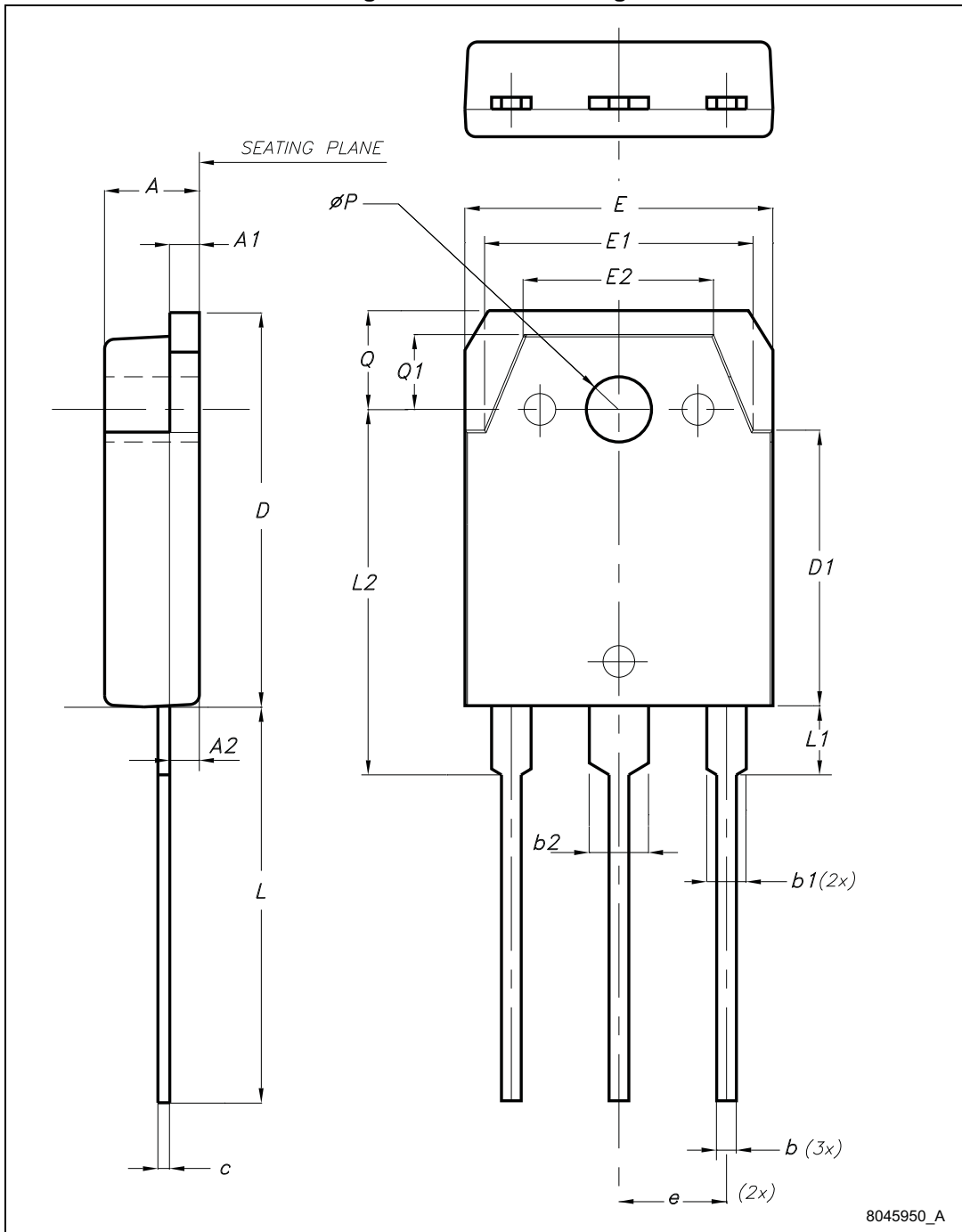

Table 9. TO-3P mechanical data

Dim.	mm		
	Min.	Typ.	Max.
A	4.60		5
A1	1.45	1.50	1.65
A2	1.20	1.40	1.60
b	0.80	1	1.20
b1	1.80		2.20
b2	2.80		3.20
c	0.55	0.60	0.75
D	19.70	19.90	20.10
D1		13.90	
E	15.40		15.80
E1		13.60	
E2		9.60	
e	5.15	5.45	5.75
L	19.50	20	20.50
L1		3.50	
L2	18.20	18.40	18.60
øP	3.10		3.30
Q		5	
Q1		3.80	



Figure 30. TO-3P drawing



8045950\_A

## 5 Revision history

Table 10. Document revision history

Date	Revision	Changes
11-Jul-2013	1	Initial release.

**Please Read Carefully:**

Information in this document is provided solely in connection with ST products. STMicroelectronics NV and its subsidiaries ("ST") reserve the right to make changes, corrections, modifications or improvements, to this document, and the products and services described herein at any time, without notice.

All ST products are sold pursuant to ST's terms and conditions of sale.

Purchasers are solely responsible for the choice, selection and use of the ST products and services described herein, and ST assumes no liability whatsoever relating to the choice, selection or use of the ST products and services described herein.

No license, express or implied, by estoppel or otherwise, to any intellectual property rights is granted under this document. If any part of this document refers to any third party products or services it shall not be deemed a license grant by ST for the use of such third party products or services, or any intellectual property contained therein or considered as a warranty covering the use in any manner whatsoever of such third party products or services or any intellectual property contained therein.

**UNLESS OTHERWISE SET FORTH IN ST'S TERMS AND CONDITIONS OF SALE ST DISCLAIMS ANY EXPRESS OR IMPLIED WARRANTY WITH RESPECT TO THE USE AND/OR SALE OF ST PRODUCTS INCLUDING WITHOUT LIMITATION IMPLIED WARRANTIES OF MERCHANTABILITY, FITNESS FOR A PARTICULAR PURPOSE (AND THEIR EQUIVALENTS UNDER THE LAWS OF ANY JURISDICTION), OR INFRINGEMENT OF ANY PATENT, COPYRIGHT OR OTHER INTELLECTUAL PROPERTY RIGHT.**

**ST PRODUCTS ARE NOT AUTHORIZED FOR USE IN WEAPONS. NOR ARE ST PRODUCTS DESIGNED OR AUTHORIZED FOR USE IN: (A) SAFETY CRITICAL APPLICATIONS SUCH AS LIFE SUPPORTING, ACTIVE IMPLANTED DEVICES OR SYSTEMS WITH PRODUCT FUNCTIONAL SAFETY REQUIREMENTS; (B) AERONAUTIC APPLICATIONS; (C) AUTOMOTIVE APPLICATIONS OR ENVIRONMENTS, AND/OR (D) AEROSPACE APPLICATIONS OR ENVIRONMENTS. WHERE ST PRODUCTS ARE NOT DESIGNED FOR SUCH USE, THE PURCHASER SHALL USE PRODUCTS AT PURCHASER'S SOLE RISK, EVEN IF ST HAS BEEN INFORMED IN WRITING OF SUCH USAGE, UNLESS A PRODUCT IS EXPRESSLY DESIGNATED BY ST AS BEING INTENDED FOR "AUTOMOTIVE, AUTOMOTIVE SAFETY OR MEDICAL" INDUSTRY DOMAINS ACCORDING TO ST PRODUCT DESIGN SPECIFICATIONS. PRODUCTS FORMALLY ESCC, QML OR JAN QUALIFIED ARE DEEMED SUITABLE FOR USE IN AEROSPACE BY THE CORRESPONDING GOVERNMENTAL AGENCY.**

Resale of ST products with provisions different from the statements and/or technical features set forth in this document shall immediately void any warranty granted by ST for the ST product or service described herein and shall not create or extend in any manner whatsoever, any liability of ST.

ST and the ST logo are trademarks or registered trademarks of ST in various countries.

Information in this document supersedes and replaces all information previously supplied.

The ST logo is a registered trademark of STMicroelectronics. All other names are the property of their respective owners.

© 2013 STMicroelectronics - All rights reserved

STMicroelectronics group of companies

Australia - Belgium - Brazil - Canada - China - Czech Republic - Finland - France - Germany - Hong Kong - India - Israel - Italy - Japan - Malaysia - Malta - Morocco - Philippines - Singapore - Spain - Sweden - Switzerland - United Kingdom - United States of America

[www.st.com](http://www.st.com)

