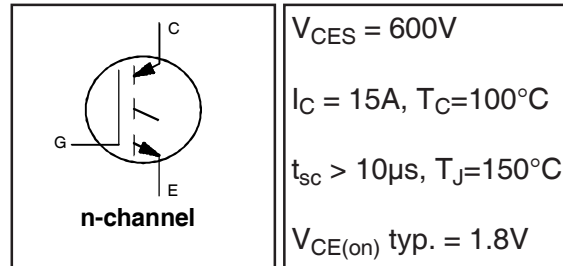


# IRGS15B60KPbF

## INSULATED GATE BIPOLAR TRANSISTOR

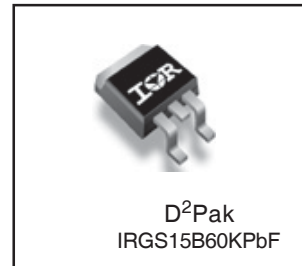
### Features

- Low VCE (on) Non Punch Through IGBT Technology.
- 10 $\mu$ s Short Circuit Capability.
- Square RBSOA.
- Positive VCE (on) Temperature Coefficient.
- Lead-Free



### Benefits

- Benchmark Efficiency for Motor Control.
- Rugged Transient Performance.
- Low EMI.
- Excellent Current Sharing in Parallel Operation.



### Absolute Maximum Ratings

	Parameter	Max.	Units
$V_{CES}$	Collector-to-Emitter Voltage	600	V
$I_C @ T_C = 25^\circ C$	Continuous Collector Current	31	A
$I_C @ T_C = 100^\circ C$	Continuous Collector Current	15	
$I_{CM}$	Pulse Collector Current $V_{ge} = 15V$	62	
$I_{LM}$	Clamped Inductive Load Current $V_{ge} = 20V$ ④	62	
$V_{GE}$	Continuous Gate-to-Emitter Voltage	$\pm 20$	V
$P_D @ T_C = 25^\circ C$	Maximum Power Dissipation	208	W
$P_D @ T_C = 100^\circ C$	Maximum Power Dissipation	83	
$T_J$	Operating Junction and	-55 to +150	°C
$T_{STG}$	Storage Temperature Range		
	Soldering Temperature, for 10 sec.	300 (0.063 in. (1.6mm) from case)	

### Thermal Resistance

	Parameter	Min.	Typ.	Max.	Units
$R_{\theta JC}$ (IGBT)	Junction-to-Case-IGBT	—	—	0.6	°C/W
$R_{\theta CS}$	Case-to-Sink (flat, greased surface)	—	0.5	—	
$R_{\theta JA}$	Junction-to-Ambient (PCB Mount steady state) ①	—	—	40	
	Weight	—	1.44	—	g (oz)

# IRGS15B60KPbF

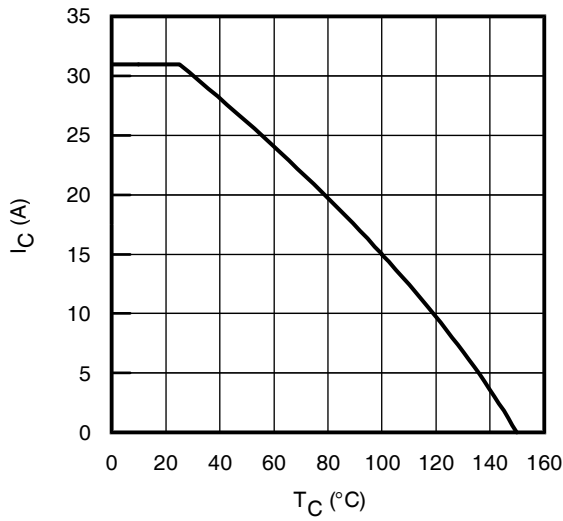
## Electrical Characteristics @ T<sub>J</sub> = 25°C (unless otherwise specified)

	Parameter	Min.	Typ.	Max.	Units	Conditions	Ref.Fig
V <sub>(BR)CES</sub>	Collector-to-Emitter Breakdown Voltage	600	—	—	V	V <sub>GE</sub> = 0V, I <sub>C</sub> = 500μA	
ΔV <sub>(BR)CES</sub> /ΔT <sub>J</sub>	Temperature Coeff. of Breakdown Voltage	—	0.3	—	V/°C	V <sub>GE</sub> = 0V, I <sub>C</sub> = 1.0mA (25°C-150°C)	
V <sub>CE(on)</sub>	Collector-to-Emitter Saturation Voltage	1.5	1.8	2.2	V	I <sub>C</sub> = 15A, V <sub>GE</sub> = 15V, T <sub>J</sub> = 25°C	5,6,7
		—	2.05	2.5		I <sub>C</sub> = 15A, V <sub>GE</sub> = 15V, T <sub>J</sub> = 125°C	8,9,10
		—	2.1	2.6		I <sub>C</sub> = 15A, V <sub>GE</sub> = 15V, T <sub>J</sub> = 150°C	
V <sub>GE(th)</sub>	Gate Threshold Voltage	3.5	4.5	5.5	V	V <sub>CE</sub> = V <sub>GE</sub> , I <sub>C</sub> = 250μA	8,9
ΔV <sub>GE(th)</sub> /ΔT <sub>J</sub>	Threshold Voltage temp. coefficient	—	-10	—	mV/°C	V <sub>CE</sub> = V <sub>GE</sub> , I <sub>C</sub> = 1.0mA (25°C - 150°C)	10,11
g <sub>fe</sub>	Forward Transconductance	—	10.6	—	S	V <sub>CE</sub> = 50V, I <sub>C</sub> = 20A, PW = 80μs	
I <sub>CES</sub>	Collector-to-Emitter Leakage Current	—	5.0	150	μA	V <sub>GE</sub> = 0V, V <sub>CE</sub> = 600V, T <sub>J</sub> = 25°C	
		—	500	1000		V <sub>GE</sub> = 0V, V <sub>CE</sub> = 600V, T <sub>J</sub> = 150°C	
I <sub>GES</sub>	Gate-to-Emitter Leakage Current	—	—	±100	nA	V <sub>GE</sub> = ± 20V	

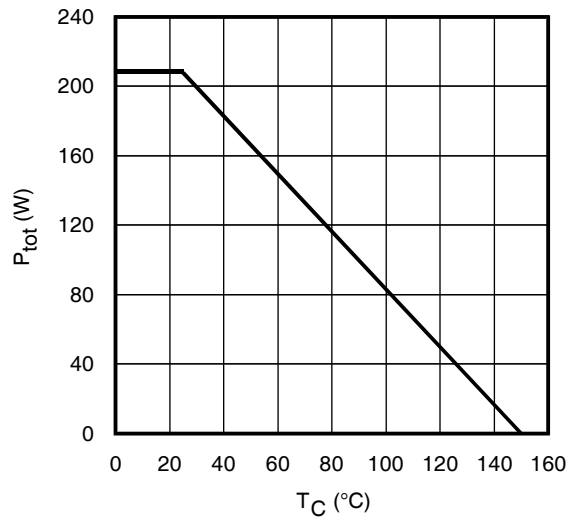
## Switching Characteristics @ T<sub>J</sub> = 25°C (unless otherwise specified)

	Parameter	Min.	Typ.	Max.	Units	Conditions	Ref.Fig
Q <sub>g</sub>	Total Gate Charge (turn-on)	—	56	84	nC	I <sub>C</sub> = 15A V <sub>GE</sub> = 15V V <sub>CC</sub> = 400V	CT1
Q <sub>ge</sub>	Gate-to-Emitter Charge (turn-on)	—	7.0	10			
Q <sub>gc</sub>	Gate-to-Collector Charge (turn-on)	—	26	39			
E <sub>on</sub>	Turn-On Switching Loss	—	220	330	μJ	I <sub>C</sub> = 15A, V <sub>CC</sub> = 400V, V <sub>GE</sub> = 15V R <sub>G</sub> = 22Ω, L = 200μH L <sub>S</sub> = 150nH T <sub>J</sub> = 25°C ②	CT4
E <sub>off</sub>	Turn-Off Switching Loss	—	340	455			
E <sub>total</sub>	Total Switching Loss	—	560	785			
t <sub>d(on)</sub>	Turn-On delay time	—	34	44	ns	I <sub>C</sub> = 15A, V <sub>CC</sub> = 400V, V <sub>GE</sub> = 15V R <sub>G</sub> = 22Ω, L = 200μH L <sub>S</sub> = 150nH T <sub>J</sub> = 25°C	CT4
t <sub>r</sub>	Rise time	—	16	22			
t <sub>d(off)</sub>	Turn-Off delay time	—	184	200			
t <sub>f</sub>	Fall time	—	20	26			
E <sub>on</sub>	Turn-On Switching Loss	—	355	470	μJ	I <sub>C</sub> = 15A, V <sub>CC</sub> = 400V, V <sub>GE</sub> = 15V R <sub>G</sub> = 22Ω, L = 200μH L <sub>S</sub> = 150nH T <sub>J</sub> = 150°C ②	CT4 12,14
E <sub>off</sub>	Turn-Off Switching Loss	—	490	600			
E <sub>total</sub>	Total Switching Loss	—	835	1070			
t <sub>d(on)</sub>	Turn-On delay time	—	34	44	ns	I <sub>C</sub> = 15A, V <sub>CC</sub> = 400V, V <sub>GE</sub> = 15V R <sub>G</sub> = 22Ω, L = 200μH L <sub>S</sub> = 150nH T <sub>J</sub> = 150°C	13, 15 CT4 WF1 WF2
t <sub>r</sub>	Rise time	—	18	25			
t <sub>d(off)</sub>	Turn-Off delay time	—	203	226			
t <sub>f</sub>	Fall time	—	28	36			
C <sub>ies</sub>	Input Capacitance	—	850	—	pF	V <sub>GE</sub> = 0V V <sub>CC</sub> = 30V f = 1.0Mhz	
C <sub>oes</sub>	Output Capacitance	—	75	—			
C <sub>res</sub>	Reverse Transfer Capacitance	—	35	—			
RBSOA	Reverse Bias Safe Operating Area	FULL SQUARE				I <sub>C</sub> = 62A V <sub>CC</sub> = 500V, V <sub>p</sub> = 600V R <sub>G</sub> = 22Ω, V <sub>GE</sub> = +20V to 0V, T <sub>J</sub> = 150°C	4 CT2
SCSOA	Short Circuit Safe Operating Area	10	—	—	μs	V <sub>CC</sub> = 360V, V <sub>p</sub> = 600V, T <sub>J</sub> = 150°C R <sub>G</sub> = 22Ω, V <sub>GE</sub> = +15V to 0V	CT3 WF3

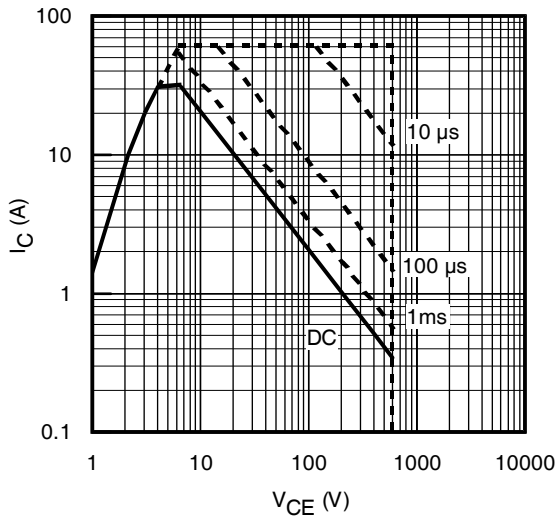
Note ① to ③ are on page 11



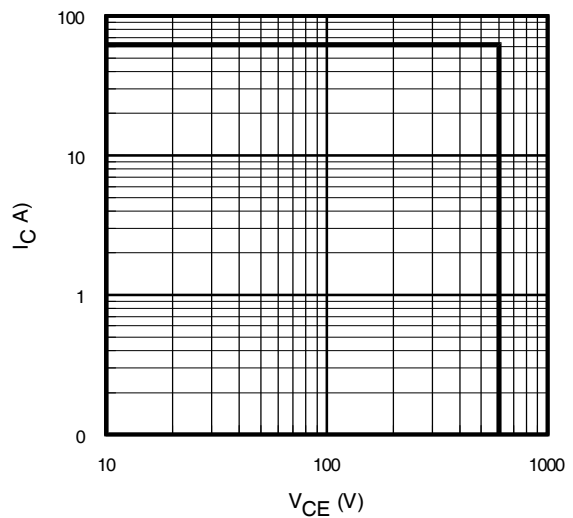
**Fig. 1** - Maximum DC Collector Current vs. Case Temperature



**Fig. 2** - Power Dissipation vs. Case Temperature

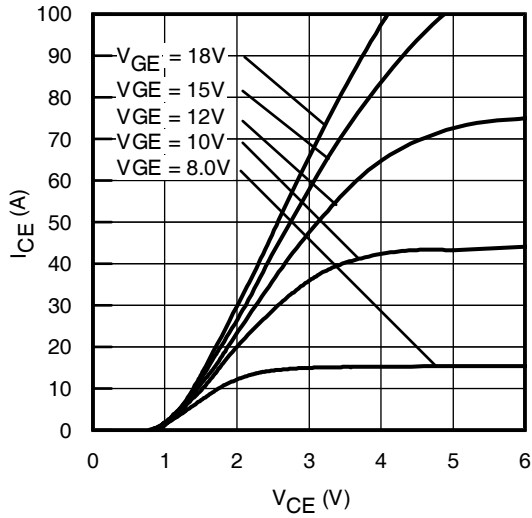


**Fig. 3** - Forward SOA  
 $T_C = 25^\circ\text{C}$ ;  $T_J \leq 150^\circ\text{C}$

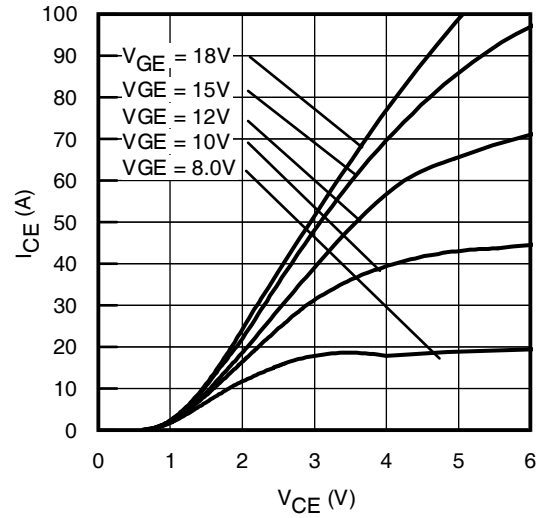


**Fig. 4** - Reverse Bias SOA  
 $T_J = 150^\circ\text{C}$ ;  $V_{GE} = 15\text{V}$

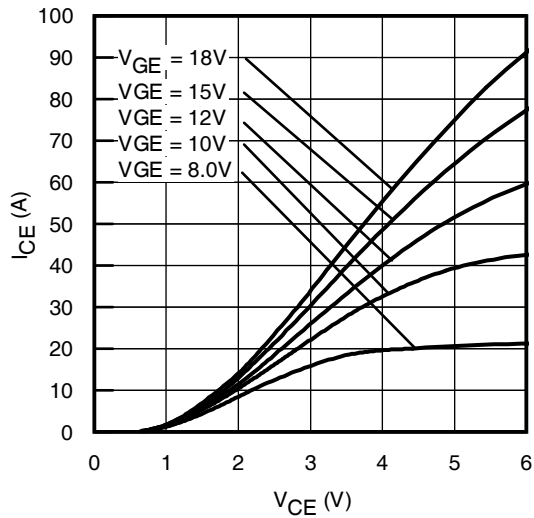
# IRGS15B60KPbF



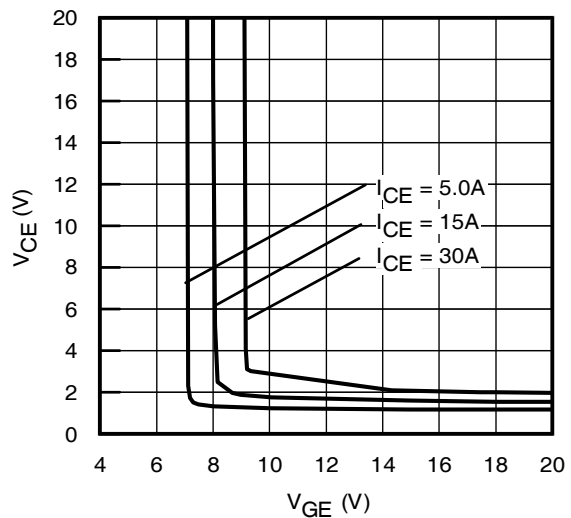
**Fig. 5** - Typ. IGBT Output Characteristics  
 $T_J = -40^\circ\text{C}$ ;  $t_p = 300\mu\text{s}$



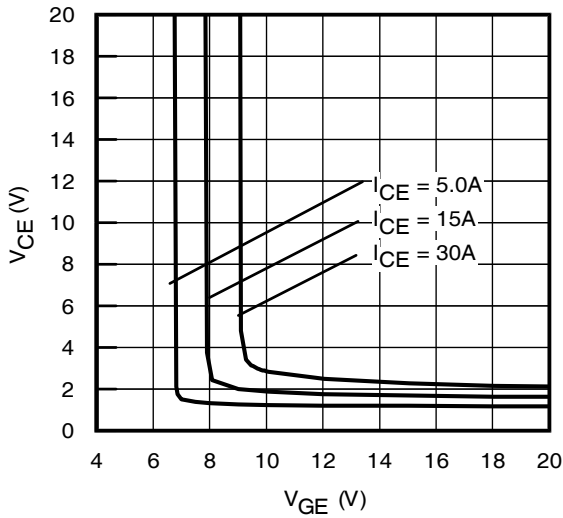
**Fig. 6** - Typ. IGBT Output Characteristics  
 $T_J = 25^\circ\text{C}$ ;  $t_p = 300\mu\text{s}$



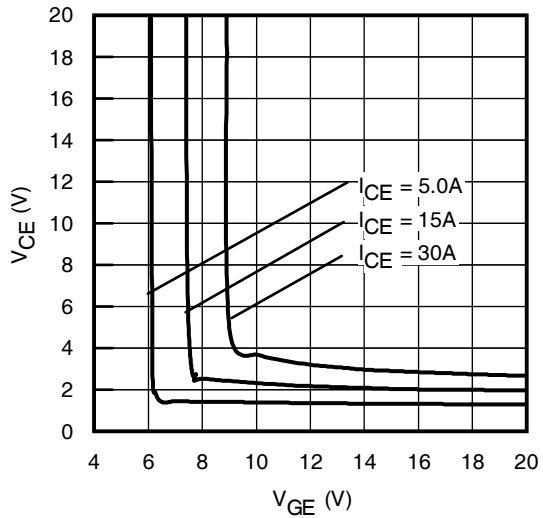
**Fig. 7** - Typ. IGBT Output Characteristics  
 $T_J = 150^\circ\text{C}$ ;  $t_p = 300\mu\text{s}$



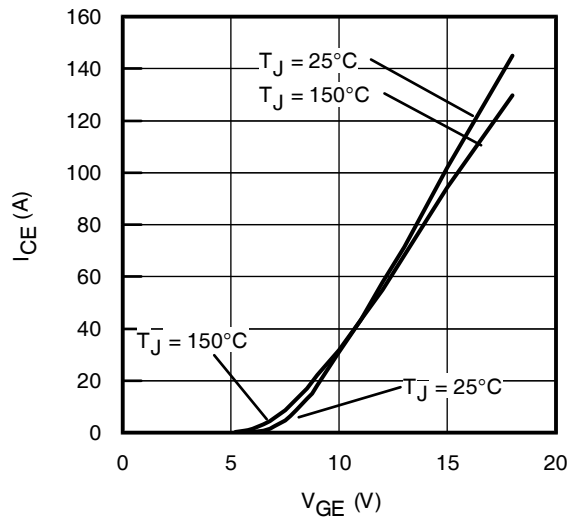
**Fig. 8** - Typical  $V_{CE}$  vs.  $V_{GE}$   
 $T_J = -40^\circ\text{C}$



**Fig. 9** - Typical  $V_{CE}$  vs.  $V_{GE}$   
 $T_J = 25^\circ\text{C}$



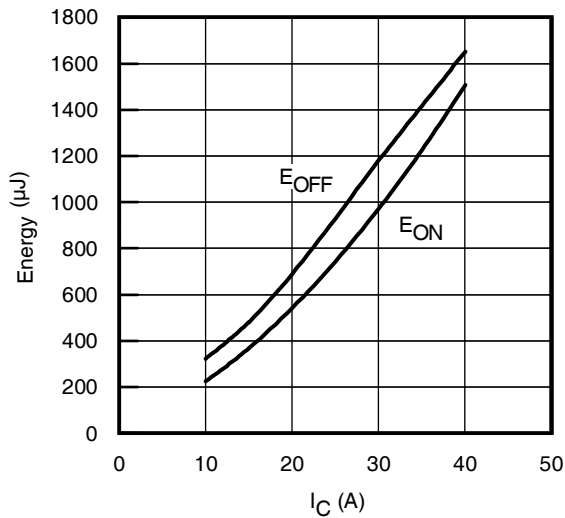
**Fig. 10** - Typical  $V_{CE}$  vs.  $V_{GE}$   
 $T_J = 150^\circ\text{C}$



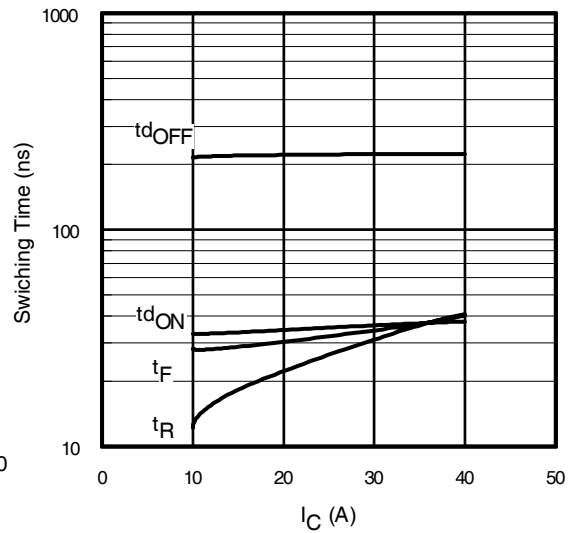
**Fig. 11** - Typ. Transfer Characteristics  
 $V_{CE} = 50\text{V}$ ;  $t_p = 10\mu\text{s}$

# IRGS15B60KPbF

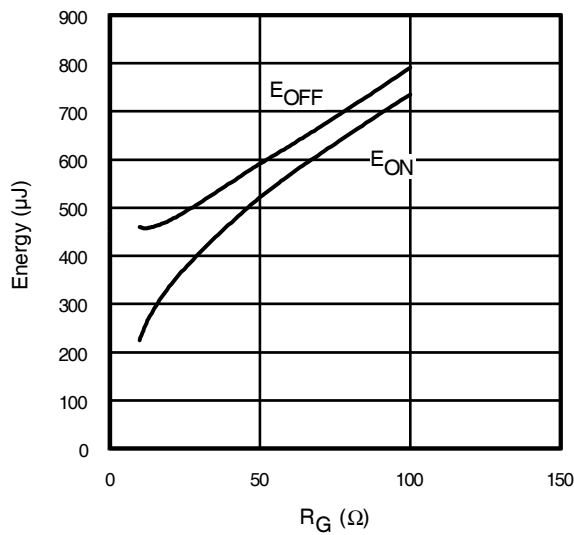
International  
**IR** Rectifier



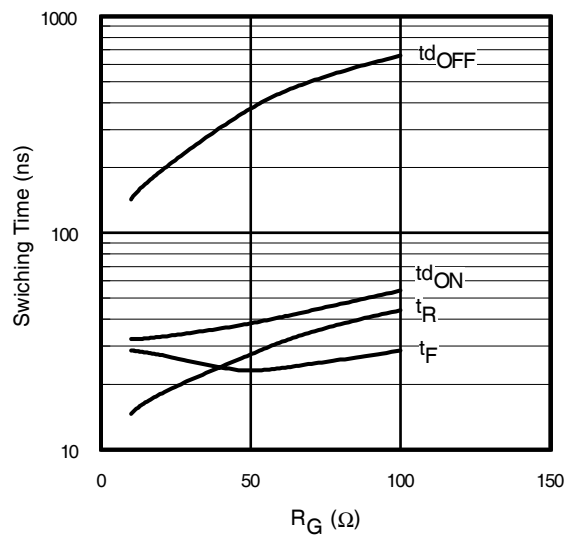
**Fig. 12** - Typ. Energy Loss vs. I<sub>C</sub>  
T<sub>J</sub> = 150°C; L=200μH; V<sub>CE</sub>= 400V  
R<sub>G</sub>= 22Ω; V<sub>GE</sub>= 15V



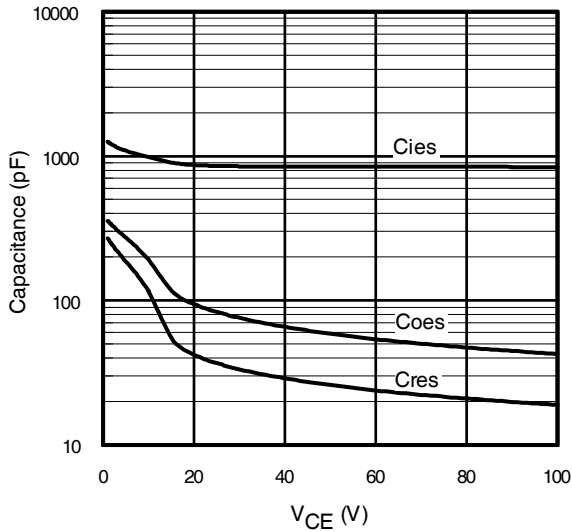
**Fig. 13** - Typ. Switching Time vs. I<sub>C</sub>  
T<sub>J</sub> = 150°C; L=200μH; V<sub>CE</sub>= 400V  
R<sub>G</sub>= 22Ω; V<sub>GE</sub>= 15V



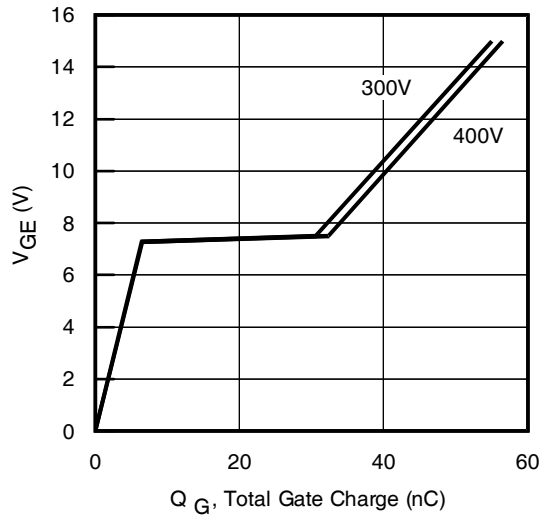
**Fig. 14** - Typ. Energy Loss vs. R<sub>G</sub>  
T<sub>J</sub> = 150°C; L=200μH; V<sub>CE</sub>= 400V  
I<sub>CE</sub>= 15A; V<sub>GE</sub>= 15V



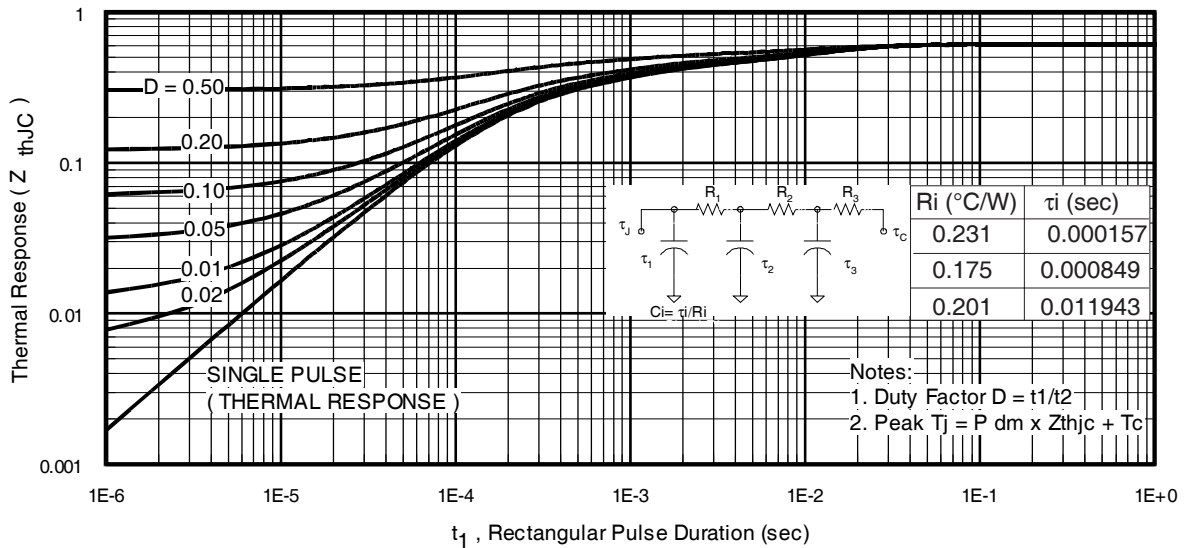
**Fig. 15** - Typ. Switching Time vs. R<sub>G</sub>  
T<sub>J</sub> = 150°C; L=200μH; V<sub>CE</sub>= 600V  
I<sub>CE</sub>= 15A; V<sub>GE</sub>= 15V



**Fig. 16-** Typ. Capacitance vs.  $V_{CE}$   
 $V_{GE} = 0V$ ;  $f = 1MHz$

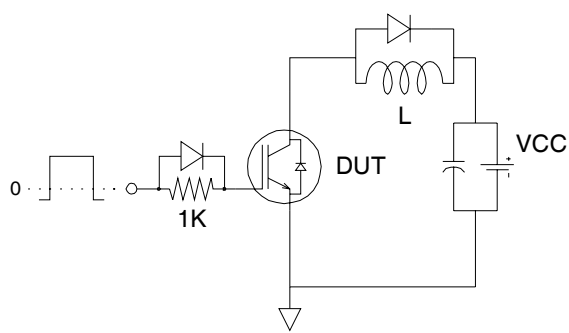


**Fig. 17 -** Typical Gate Charge vs.  $V_{GE}$   
 $I_{CE} = 15A$ ;  $L = 600\mu H$

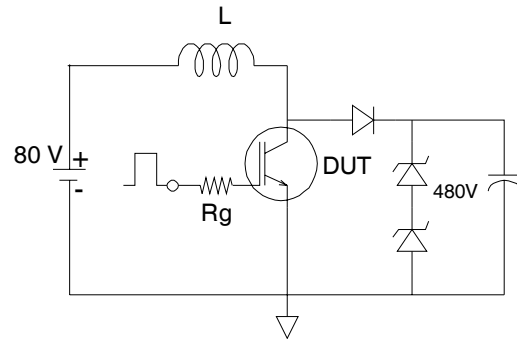


**Fig 18.** Maximum Transient Thermal Impedance, Junction-to-Case (IGBT)

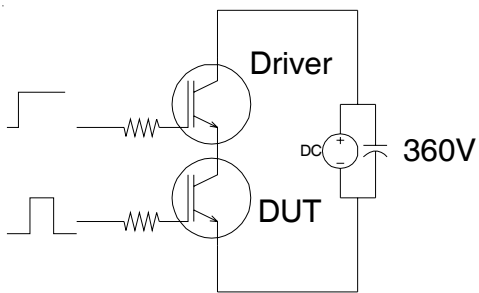
# IRGS15B60KPbF



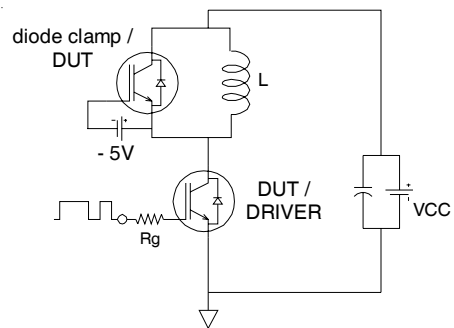
**Fig.C.T.1** - Gate Charge Circuit (turn-off)



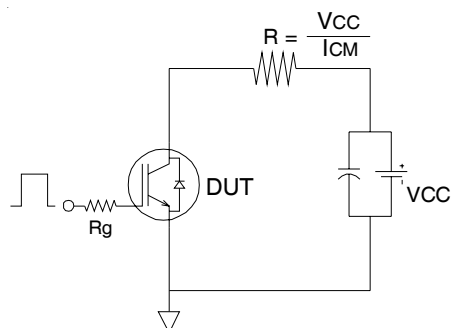
**Fig.C.T.2** - RBSOA Circuit



**Fig.C.T.3** - S.C.SOA Circuit

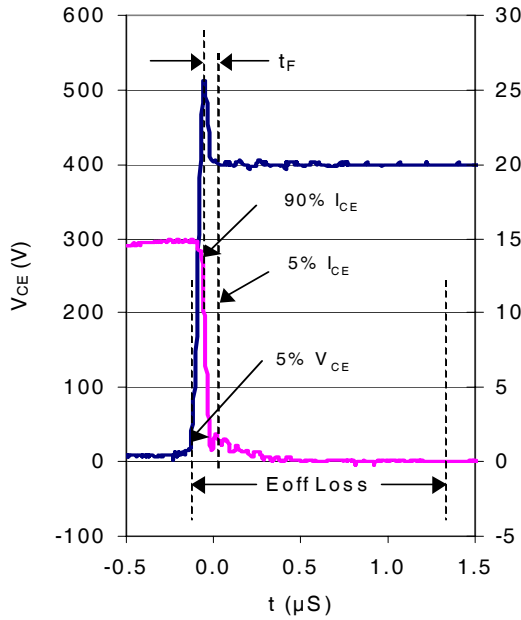


**Fig.C.T.4** - Switching Loss Circuit

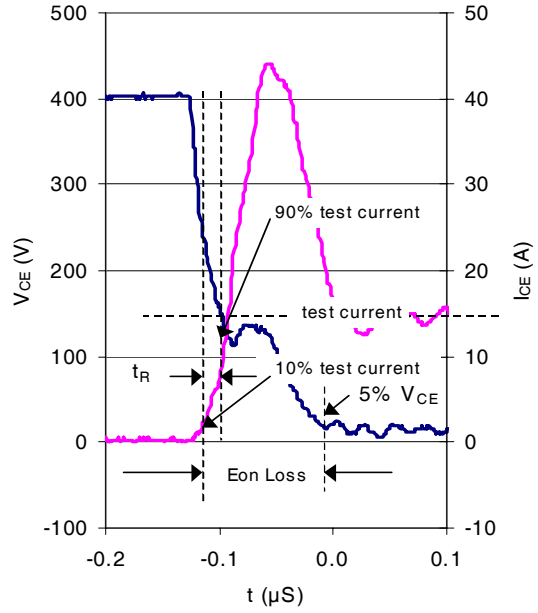


**Fig.C.T.5** - Resistive Load Circuit

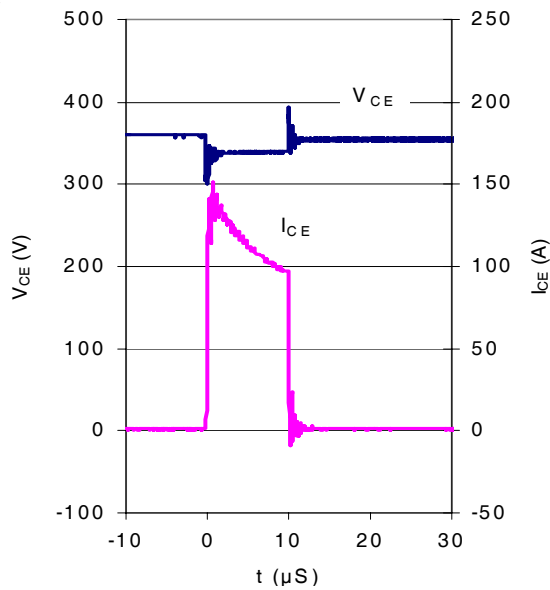




WF.1- Typ. Turn-off Loss  
 @  $T_J = 150^\circ\text{C}$  using CT.4



WF.2- Typ. Turn-on Loss  
 @  $T_J = 150^\circ\text{C}$  using Fig. CT.4



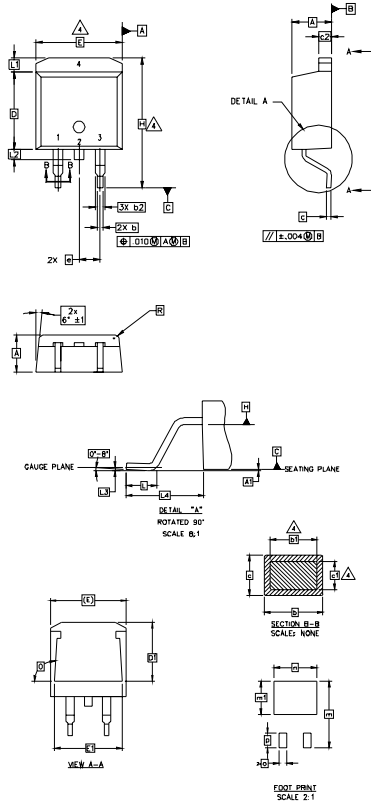
WF.3- Typ. Short Circuit  
 @  $T_J = 150^\circ\text{C}$  using CT.3

# IRGS15B60KPbF



## D<sup>2</sup>Pak Package Outline

Dimensions are shown in millimeters (inches)



- NOTES:
1. DIMENSIONING AND TOLERANCING PER ASME Y14.5M-1994
  2. DIMENSIONS ARE SHOWN IN MILLIMETERS [INCHES].
  3. DIMENSION D & E DO NOT INCLUDE MOLD FLASH. MOLD FLASH SHALL NOT EXCEED 0.127 [0.005"] PER SIDE. THESE DIMENSIONS ARE MEASURED AT THE OUTMOST EXTREMES OF THE PLASTIC BODY.
  4. DIMENSION b1 AND c1 APPLY TO BASE METAL ONLY.
  5. CONTROLLING DIMENSION: INCH.

SYMBOL	DIMENSIONS				NOTES
	MILLIMETERS		INCHES		
	MIN.	MAX.	MIN.	MAX.	
A	4.06	4.83	.160	.190	4
A1	0.00	0.254	.000	.010	
b	0.51	0.99	.020	.039	4
b1	0.51	0.89	.020	.035	
b2	1.14	1.78	.045	.070	4
c	0.38	0.74	.015	.029	
c1	0.38	0.58	.015	.023	3
c2	1.14	1.65	.045	.065	
D	8.51	9.65	.335	.380	3
D1	6.86		.270		
E	9.65	10.67	.380	.420	3
E1	6.22		.245		
e	2.54 BSC		.100 BSC		
H	14.61	15.88	.575	.625	
L	1.78	2.79	.070	.110	
L1	1.27	1.65	.050	.065	
L2	1.27	1.78	.050	.070	
L3	0.25 BSC		.010 BSC		
L4	4.78	5.28	.188	.208	
m	17.78		.700		
m1	8.89		.350		
n	11.43		.450		
o	2.08		.082		
p	3.81		.150		
R	0.51	0.71	.020	.028	
θ	90°	93°	90°	93°	

### LEAD ASSIGNMENTS

- HEXFET
- 1.- GATE
  - 2, 4.- DRAIN
  - 3.- SOURCE

### IGBTs, CoPACK

- 1.- GATE
- 2, 4.- COLLECTOR
- 3.- EMITTER

### DIODES

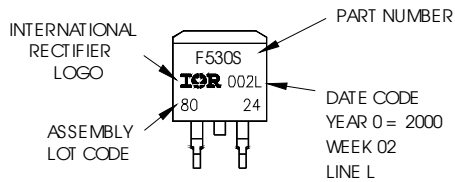
- 1.- ANODE \*
- 2, 4.- CATHODE
- 3.- ANODE

\* PART DEPENDENT.

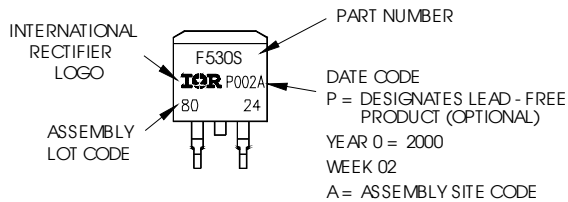
## D<sup>2</sup>Pak Part Marking Information

EXAMPLE: THIS IS AN IRF530S WITH  
LOT CODE 8024  
ASSEMBLED ON WW02, 2000  
IN THE ASSEMBLY LINE "L"

Note: "P" in assembly line position  
indicates "Lead - Free"

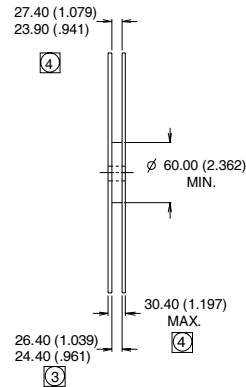
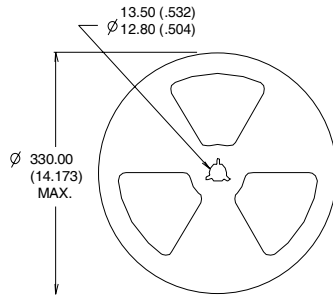
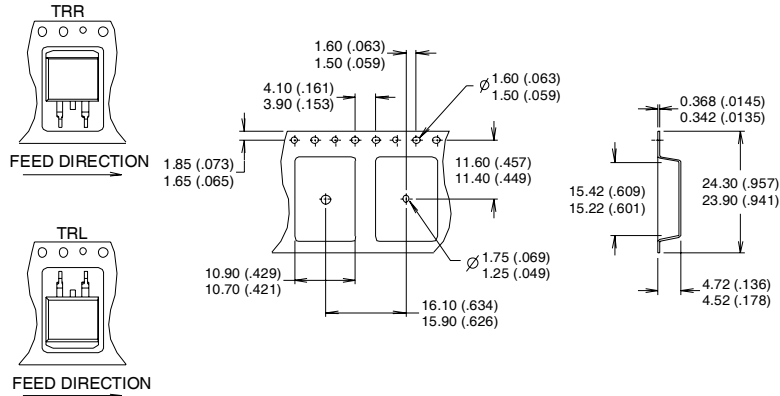


OR



## D<sup>2</sup>Pak Tape & Reel Information

Dimensions are shown in millimeters (inches)



- NOTES:
1. COMFORMS TO EIA-418.
  2. CONTROLLING DIMENSION: MILLIMETER.
  3. DIMENSION MEASURED @ HUB.
  4. INCLUDES FLANGE DISTORTION @ OUTER EDGE.

**Notes:**

- ① This is applied to D<sup>2</sup>Pak, when mounted on 1" square PCB ( FR-4 or G-10 Material ).  
 For recommended footprint and soldering techniques refer to application note #AN-994.
- ② Energy losses include "tail" and diode reverse recovery, using Diode HF15D060ACE.
- ③  $V_{CC} = 80\% (V_{CES})$ ,  $V_{GE} = 20V$ ,  $L = 100\mu H$ ,  $R_G = 22\Omega$ .

Data and specifications subject to change without notice.  
 This product has been designed and qualified for Industrial market.  
 Qualification Standards can be found on IR's Web site.