

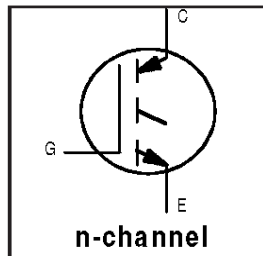
# IRG4PH30KPbF

## INSULATED GATE BIPOLAR TRANSISTOR

## Short Circuit Rated UltraFast IGBT

### Features

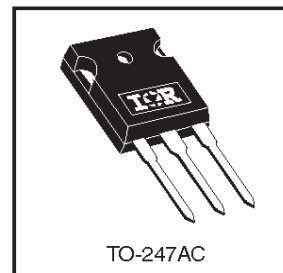
- High short circuit rating optimized for motor control,  $t_{sc} = 10\mu s$ ,  $V_{CC} = 720V$ ,  $T_J = 125^\circ C$ ,  $V_{GE} = 15V$
- Combines low conduction losses with high switching speed
- Latest generation design provides tighter parameter distribution and higher efficiency than previous generations
- Lead-Free



$V_{CES} = 1200V$
$V_{CE(on) typ.} = 3.10V$
@ $V_{GE} = 15V, I_C = 10A$

### Benefits

- As a Freewheeling Diode we recommend our HEXFRED™ ultrafast, ultrasoft recovery diodes for minimum EMI / Noise and switching losses in the Diode and IGBT
- Latest generation 4 IGBT's offer highest power density motor controls possible
- This part replaces the IRGPH30K and IRGPH30M devices



### Absolute Maximum Ratings

	Parameter	Max.	Units
$V_{CES}$	Collector-to-Emitter Voltage	1200	V
$I_C @ T_C = 25^\circ C$	Continuous Collector Current	20	A
$I_C @ T_C = 100^\circ C$	Continuous Collector Current	10	
$I_{CM}$	Pulsed Collector Current ①	40	
$I_{LM}$	Clamped Inductive Load Current ②	40	
$t_{sc}$	Short Circuit Withstand Time	10	$\mu s$
$V_{GE}$	Gate-to-Emitter Voltage	$\pm 20$	V
$E_{ARV}$	Reverse Voltage Avalanche Energy ③	121	mJ
$P_D @ T_C = 25^\circ C$	Maximum Power Dissipation	100	W
$P_D @ T_C = 100^\circ C$	Maximum Power Dissipation	42	
$T_J$	Operating Junction and Storage Temperature Range	-55 to +150	$^\circ C$
$T_{STG}$			
	Mounting torque, 6-32 or M3 screw.	10 lbf*in (1.1N*m)	

### Thermal Resistance

	Parameter	Typ.	Max.	Units
$R_{\theta JC}$	Junction-to-Case	---	1.2	$^\circ C/W$
$R_{\theta CS}$	Case-to-Sink, Flat, Greased Surface	0.24	---	
$R_{\theta JA}$	Junction-to-Ambient, typical socket mount	---	40	
Wt	Weight	6 (0.21)	---	g (oz)

## Electrical Characteristics @ $T_J = 25^\circ\text{C}$ (unless otherwise specified)

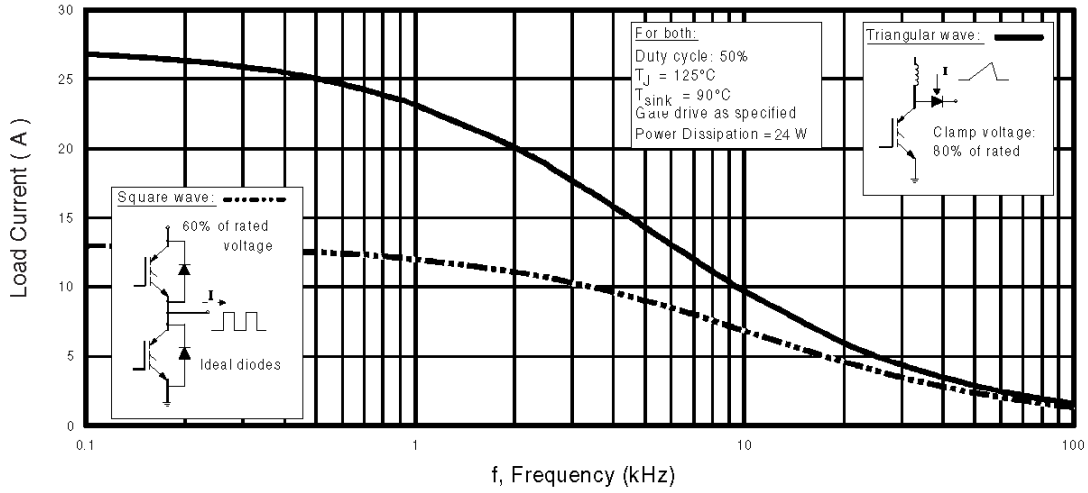
	Parameter	Min.	Typ.	Max.	Units	Conditions
$V_{(BR)CES}$	Collector-to-Emitter Breakdown Voltage	1200	—	—	V	$V_{GE} = 0V, I_C = 250\mu A$
$V_{(BR)ECS}$	Emitter-to-Collector Breakdown Voltage ④	18	—	—	V	$V_{GE} = 0V, I_C = 1.0A$
$\Delta V_{(BR)CES}/\Delta T_J$	Temperature Coeff. of Breakdown Voltage	—	0.19	—	V/°C	$V_{GE} = 0V, I_C = 2.0mA$
$V_{CE(ON)}$	Collector-to-Emitter Saturation Voltage	—	3.10	4.2	V	$I_C = 10A$ $V_{GE} = 15V$ See Fig.2, 5
		—	3.90	—		
		—	3.01	—		
$V_{GE(th)}$	Gate Threshold Voltage	3.0	—	6.0		$I_C = 10A, T_J = 150^\circ\text{C}$
$\Delta V_{GE(th)}/\Delta T_J$	Temperature Coeff. of Threshold Voltage	—	-12	—	mV/°C	$V_{CE} = V_{GE}, I_C = 250\mu A$
$g_{fe}$	Forward Transconductance ⑤	4.3	6.5	—	S	$V_{CE} = 100V, I_C = 10A$
$I_{CES}$	Zero Gate Voltage Collector Current	—	—	250	$\mu A$	$V_{GE} = 0V, V_{CE} = 1200V$
		—	—	2.0		$V_{GE} = 0V, V_{CE} = 10V, T_J = 25^\circ\text{C}$
		—	—	2000		$V_{GE} = 0V, V_{CE} = 1200V, T_J = 150^\circ\text{C}$
$I_{GES}$	Gate-to-Emitter Leakage Current	—	—	$\pm 100$	nA	$V_{GE} = \pm 20V$

## Switching Characteristics @ $T_J = 25^\circ\text{C}$ (unless otherwise specified)

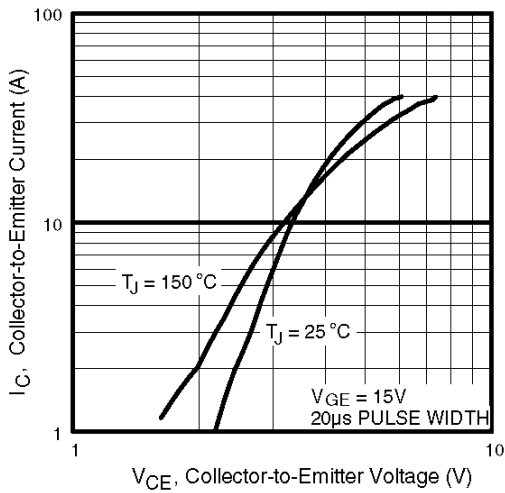
	Parameter	Min.	Typ.	Max.	Units	Conditions
$Q_g$	Total Gate Charge (turn-on)	—	53	80	nC	$I_C = 10A$ $V_{CC} = 400V$ $V_{GE} = 15V$ See Fig.8
$Q_{ge}$	Gate - Emitter Charge (turn-on)	—	9.0	14		
$Q_{gc}$	Gate - Collector Charge (turn-on)	—	21	32		
$t_{d(on)}$	Turn-On Delay Time	—	28	—	ns	$T_J = 25^\circ\text{C}$ $I_C = 10A, V_{CC} = 960V$ $V_{GE} = 15V, R_G = 23\Omega$ Energy losses include "tail" See Fig. 9,10,14
$t_r$	Rise Time	—	23	—		
$t_{d(off)}$	Turn-Off Delay Time	—	200	300		
$t_f$	Fall Time	—	110	170		
$E_{on}$	Turn-On Switching Loss	—	0.64	—	mJ	See Fig. 9,10,14
$E_{off}$	Turn-Off Switching Loss	—	0.92	—		
$E_s$	Total Switching Loss	—	1.56	2.4		
$t_{sc}$	Short Circuit Withstand Time	10	—	—	$\mu s$	$V_{CC} = 720V, T_J = 125^\circ\text{C}$ $V_{GE} = 15V, R_G = 23\Omega$
$t_{d(on)}$	Turn-On Delay Time	—	27	—	ns	$T_J = 150^\circ\text{C}$ , $I_C = 10A, V_{CC} = 960V$ $V_{GE} = 15V, R_G = 23\Omega$ Energy losses include "tail" See Fig. 10,11,14
$t_r$	Rise Time	—	26	—		
$t_{d(off)}$	Turn-Off Delay Time	—	310	—		
$t_f$	Fall Time	—	330	—		
$E_s$	Total Switching Loss	—	3.18	—	mJ	
$L_E$	Internal Emitter Inductance	—	13	—	nH	Measured 5mm from package
$C_{ies}$	Input Capacitance	—	800	—	pF	$V_{GE} = 0V$ $V_{CC} = 30V$ $f = 1.0MHz$ See Fig. 7
$C_{oes}$	Output Capacitance	—	60	—		
$C_{res}$	Reverse Transfer Capacitance	—	14	—		

### Notes:

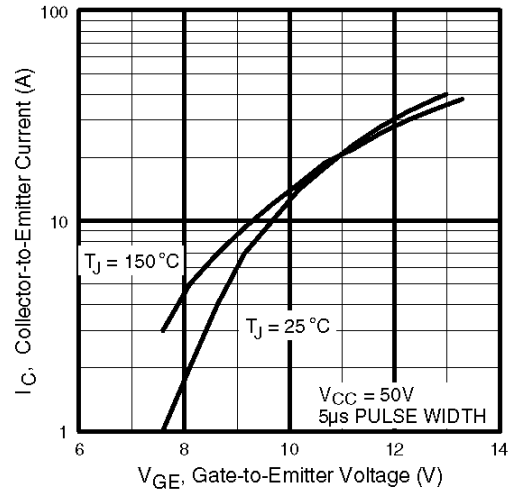
- ① Repetitive rating;  $V_{GE} = 20V$ , pulse width limited by max. junction temperature. ( See fig. 13b )
- ②  $V_{CC} = 80\%(V_{CES})$ ,  $V_{GE} = 20V$ ,  $L = 10\mu H$ ,  $R_G = 23\Omega$ , (See fig. 13a)
- ③ Repetitive rating; pulse width limited by maximum junction temperature.
- ④ Pulse width  $\leq 80\mu s$ ; duty factor  $\leq 0.1\%$ .
- ⑤ Pulse width  $5.0\mu s$ , single shot.



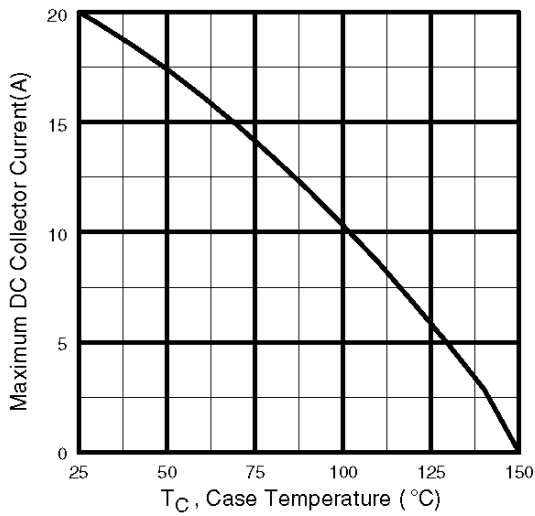
**Fig. 1** - Typical Load Current vs. Frequency  
(Load Current =  $I_{RMS}$  of fundamental)



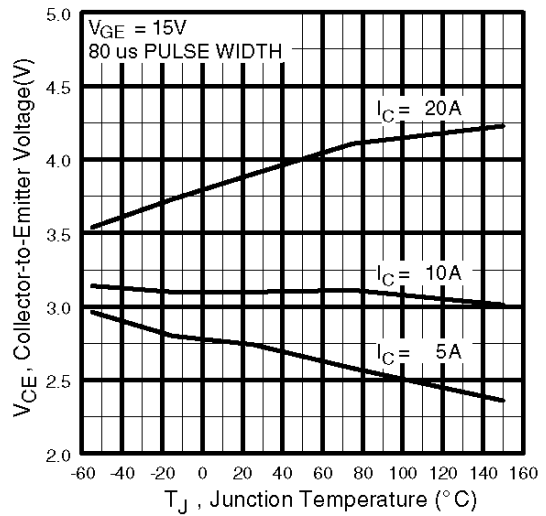
**Fig. 2** - Typical Output Characteristics



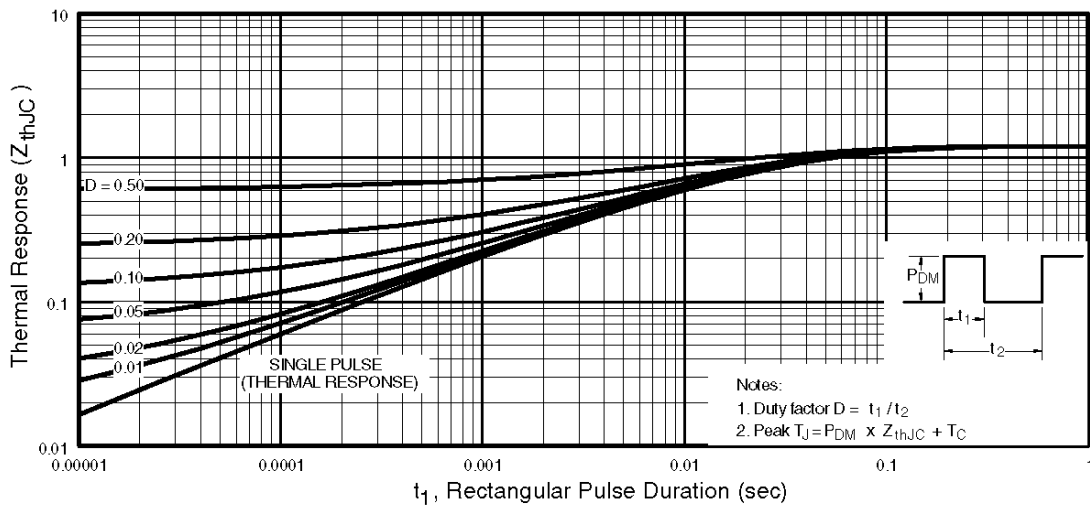
**Fig. 3** - Typical Transfer Characteristics



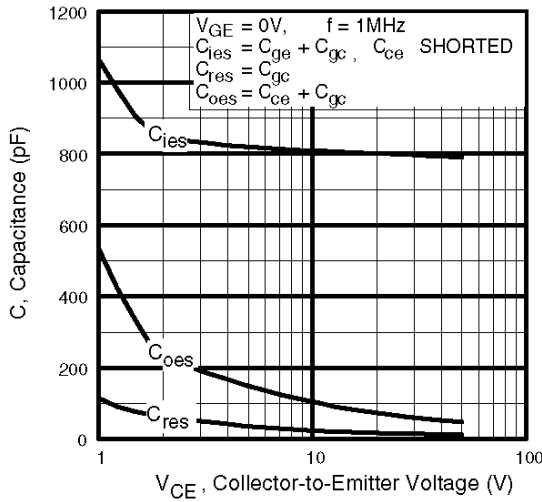
**Fig. 4** - Maximum Collector Current vs. Case Temperature



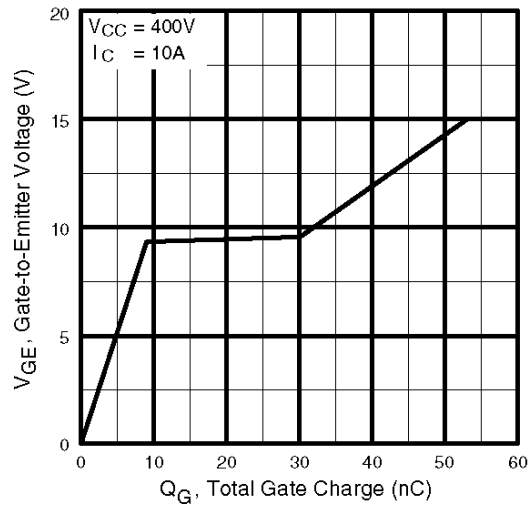
**Fig. 5** - Typical Collector-to-Emitter Voltage vs. Junction Temperature



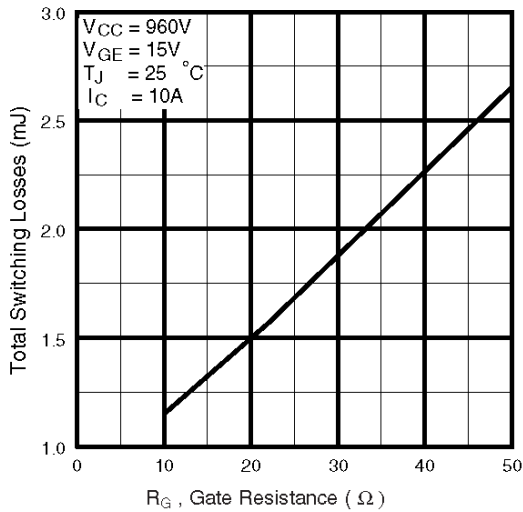
**Fig. 6** - Maximum Effective Transient Thermal Impedance, Junction-to-Case



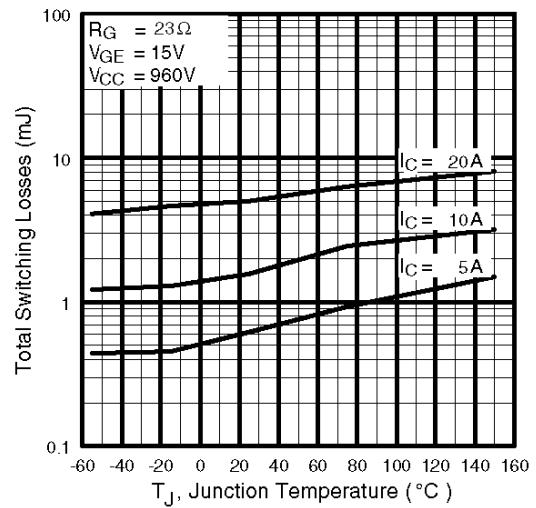
**Fig. 7** - Typical Capacitance vs. Collector-to-Emitter Voltage



**Fig. 8** - Typical Gate Charge vs. Gate-to-Emitter Voltage

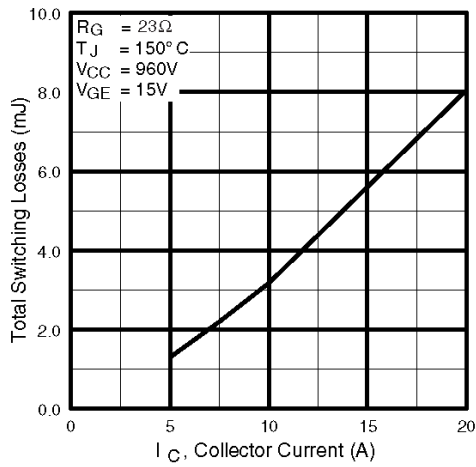


**Fig. 9** - Typical Switching Losses vs. Gate Resistance

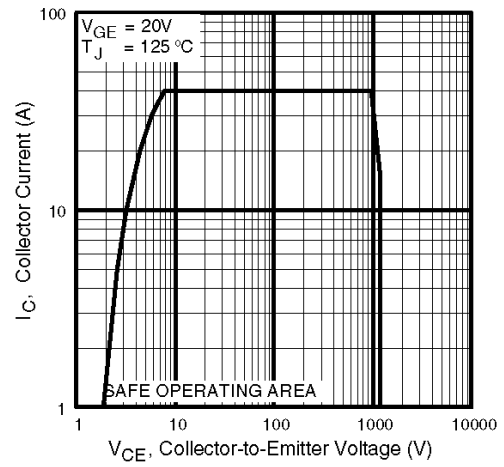


**Fig. 10** - Typical Switching Losses vs. Junction Temperature

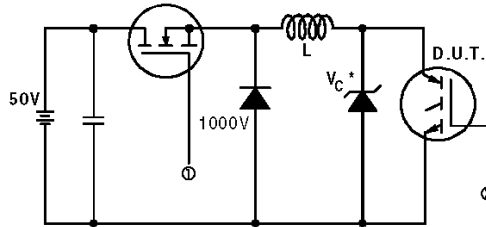
# IRG4PH30KPbF



**Fig. 11** - Typical Switching Losses vs. Collector-to-Emitter Current

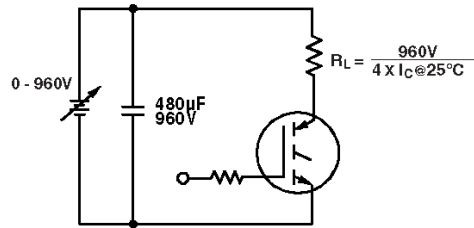


**Fig. 12** - Turn-Off SOA

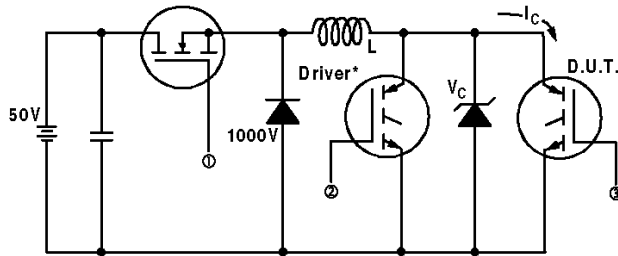


\* Driver same type as D.U.T.;  $V_c = 80\%$  of  $V_{ce(max)}$   
 \* Note: Due to the 50V power supply, pulse width and inductor will increase to obtain rated  $I_d$ .

**Fig. 13a** - Clamped Inductive Load Test Circuit

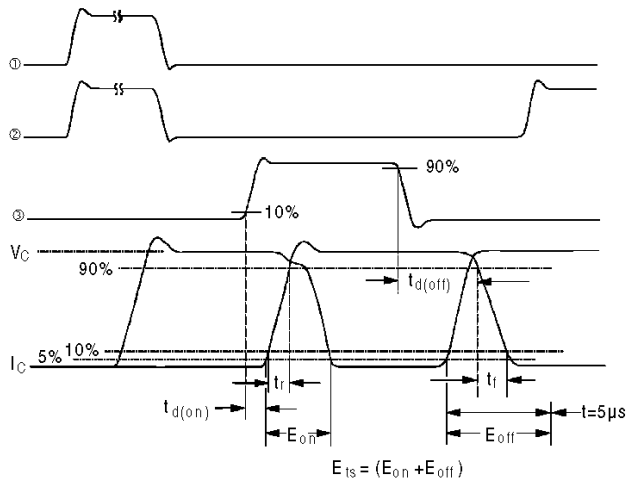


**Fig. 13b** - Pulsed Collector Current Test Circuit



**Fig. 14a** - Switching Loss Test Circuit

\* Driver same type as D.U.T.,  $V_c = 960V$



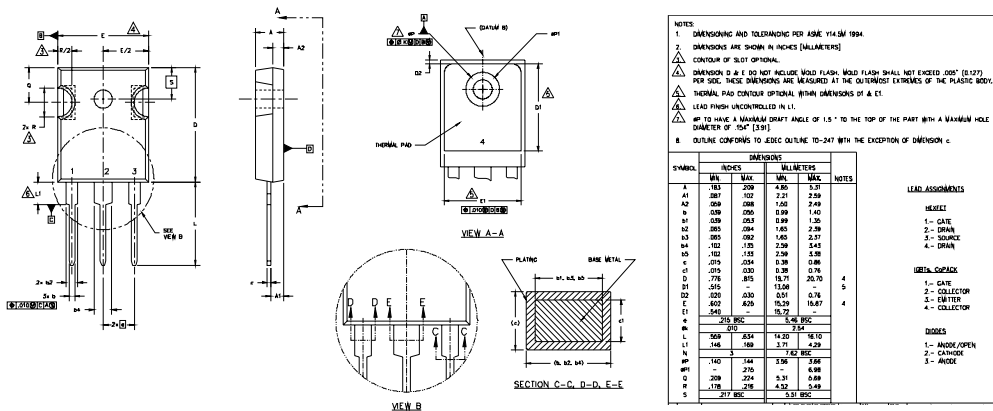
**Fig. 14b** - Switching Loss Waveforms

# IRG4PH30KPbF

International  
**IR** Rectifier

## TO-247AC Package Outline

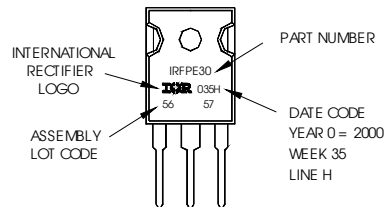
Dimensions are shown in millimeters (inches)



## TO-247AC Part Marking Information

EXAMPLE: THIS IS AN IRFP30  
WITH ASSEMBLY  
LOT CODE 5667  
ASSEMBLED ON WW 35, 2000  
IN THE ASSEMBLY LINE "H"

**Note:** "P" in assembly line position indicates "Lead-Free"



Data and specifications subject to change without notice.

International  
**IR** Rectifier

IR WORLD HEADQUARTERS: 233 Kansas St., El Segundo, California 90245, USA Tel: (310) 252-7105  
TAC Fax: (310) 252-7903

Visit us at [www.irf.com](http://www.irf.com) for sales contact information.06/04

[www.irf.com](http://www.irf.com)