

Insulated Gate Bipolar Transistor with Ultrafast Soft Recovery Diode

$V_{CES} = 600V$
$I_C = 50A, T_C = 100^\circ C$
$t_{SC} \geq 5\mu s, T_{J(max)} = 175^\circ C$
$V_{CE(ON)} \text{ typ.} = 1.65V @ I_C = 35A$

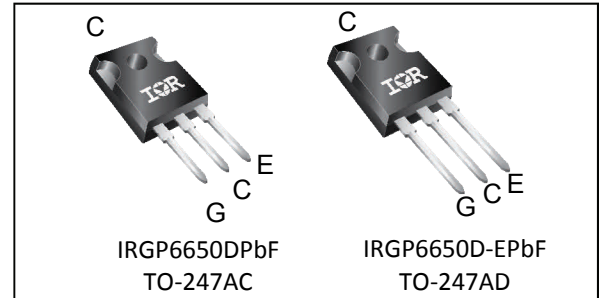
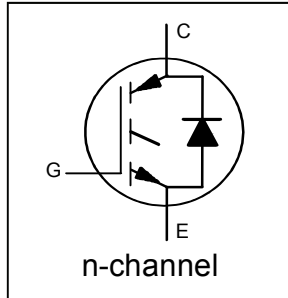

G	C	E
Gate	Collector	Emitter

Applications

- Welding
- H Bridge Converters

Features	Benefits
Low $V_{CE(ON)}$ and Switching Losses	High Efficiency in a Wide Range of Applications
Optimized Diode for Full Bridge Hard Switch Converters	Optimized for Welding and H Bridge Converters
Square RBSOA and Maximum Temperature of $175^\circ C$	Improved Reliability due to Rugged Hard Switching Performance and High Power Capability
$5\mu s$ Short Circuit	Enables Short Circuit Protection Operation
Positive $V_{CE(ON)}$ Temperature Co-efficient	Excellent Current Sharing in Parallel Operation
Lead-free, RoHS compliant	Environmentally friendly

Base part number	Package Type	Standard Pack		Orderable Part Number
		Form	Quantity	
IRGP6650DPbF	TO-247AC	Tube	25	IRGP6650DPbF
IRGP6650D-EPbF	TO-247AD	Tube	25	IRGP6650D-EPbF

Absolute Maximum Ratings

	Parameter	Max.	Units
V_{CES}	Collector-to-Emitter Voltage	600	V
$I_C @ T_C = 25^\circ C$	Continuous Collector Current	80	A
$I_C @ T_C = 100^\circ C$	Continuous Collector Current	50	
I_{CM}	Pulse Collector Current, $V_{GE} = 15V$	105	
I_{LM}	Clamped Inductive Load Current, $V_{GE} = 20V$ ①	140	
$I_{FRM} @ T_C = 100^\circ C$	Diode Repetitive Peak Forward Current④⑥	25	
I_{FM}	Diode Maximum Forward Current ④	140	
V_{GE}	Continuous Gate-to-Emitter Voltage	± 20	V
$P_D @ T_C = 25^\circ C$	Maximum Power Dissipation	306	W
$P_D @ T_C = 100^\circ C$	Maximum Power Dissipation	153	
T_J T_{STG}	Operating Junction and Storage Temperature Range	-40 to +175	$^\circ C$
	Soldering Temperature, for 10 sec.	300 (0.063 in. (1.6mm) from case)	
	Mounting Torque, 6-32 or M3 Screw	10 lbf·in (1.1 N·m)	

Thermal Resistance

	Parameter	Min.	Typ.	Max.	Units
$R_{\theta JC}$ (IGBT)	Thermal Resistance Junction-to-Case-(each IGBT) ②	—	—	0.49	$^\circ C/W$
$R_{\theta JC}$ (Diode)	Thermal Resistance Junction-to-Case-(each Diode) ②	—	—	3.35	
$R_{\theta CS}$	Thermal Resistance, Case-to-Sink (flat, greased surface)	—	0.24	—	
$R_{\theta JA}$	Thermal Resistance, Junction-to-Ambient (typical socket mount)	—	—	40	

Electrical Characteristics @ T_J = 25°C (unless otherwise specified)

	Parameter	Min.	Typ.	Max.	Units	Conditions
V _{(BR)CES}	Collector-to-Emitter Breakdown Voltage	600	—	—	V	V _{GE} = 0V, I _C = 100μA ③
ΔV _{(BR)CES} /ΔT _J	Temperature Coeff. of Breakdown Voltage	—	0.45	—	V/°C	V _{GE} = 0V, I _C = 1.0mA (25°C-175°C)
V _{CE(on)}	Collector-to-Emitter Saturation Voltage	—	1.65	1.95	V	I _C = 35A, V _{GE} = 15V, T _J = 25°C
		—	2.05	—		I _C = 35A, V _{GE} = 15V, T _J = 150°C
		—	2.10	—		I _C = 35A, V _{GE} = 15V, T _J = 175°C
V _{GE(th)}	Gate Threshold Voltage	4.0	—	6.5	V	V _{CE} = V _{GE} , I _C = 1.0mA
ΔV _{GE(th)} /ΔT _J	Threshold Voltage Temperature Coeff.	—	-18	—	mV/°C	V _{CE} = V _{GE} , I _C = 1.0mA (25°C-175°C)
g _{fe}	Forward Transconductance	—	22	—	S	V _{CE} = 50V, I _C = 35A, PW = 20μs
I _{CES}	Collector-to-Emitter Leakage Current	—	1.0	50	μA	V _{GE} = 0V, V _{CE} = 600V
		—	600	—		V _{GE} = 0V, V _{CE} = 600V, T _J = 175°C
I _{GES}	Gate-to-Emitter Leakage Current	—	—	±100	nA	V _{GE} = ±20V
V _F	Diode Forward Voltage Drop	—	1.80	2.80	V	I _F = 8A
		—	1.30	—		I _F = 8A, T _J = 175°C

Switching Characteristics @ T_J = 25°C (unless otherwise specified)

	Parameter	Min.	Typ.	Max	Units	Conditions
Q _g	Total Gate Charge (turn-on)	—	75	—	nC	I _C = 35A V _{GE} = 15V V _{CC} = 400V
Q _{ge}	Gate-to-Emitter Charge (turn-on)	—	20	—		
Q _{gc}	Gate-to-Collector Charge (turn-on)	—	30	—		
E _{on}	Turn-On Switching Loss	—	300	—	μJ	I _C = 35A, V _{CC} = 400V, V _{GE} =15V R _G = 10Ω, L=210μH, T _J = 25°C
E _{off}	Turn-Off Switching Loss	—	630	—		
E _{total}	Total Switching Loss	—	930	—		
t _{d(on)}	Turn-On delay time	—	40	—	ns	Energy losses include tail & diode reverse recovery ⑤
t _r	Rise time	—	30	—		
t _{d(off)}	Turn-Off delay time	—	105	—		
t _f	Fall time	—	20	—		
E _{on}	Turn-On Switching Loss	—	640	—		
E _{off}	Turn-Off Switching Loss	—	930	—	μJ	I _C = 35A, V _{CC} = 400V, V _{GE} =15V R _G = 10Ω, L=210μH, T _J = 175°C
E _{total}	Total Switching Loss	—	1570	—		
t _{d(on)}	Turn-On delay time	—	40	—		
t _r	Rise time	—	30	—	ns	Energy losses include tail & diode reverse recovery ⑤
t _{d(off)}	Turn-Off delay time	—	120	—		
t _f	Fall time	—	60	—		
C _{ies}	Input Capacitance	—	2220	—	pF	V _{GE} = 0V V _{CC} = 30V f = 1.0MHz
C _{oes}	Output Capacitance	—	130	—		
C _{res}	Reverse Transfer Capacitance	—	65	—		
RBSOA	Reverse Bias Safe Operating Area	FULL SQUARE				T _J = 175°C, I _C = 140A V _{CC} = 480V, V _p ≤ 600V V _{GE} = +20V to 0V
SCSOA	Short Circuit Safe Operating Area	5	—	—	μs	T _J = 150°C, V _{CC} = 400V, V _p ≤ 600V V _{GE} = +15V to 0V
E _{rec}	Reverse Recovery Energy of the Diode	—	165	—	μJ	T _J = 175°C
t _{rr}	Diode Reverse Recovery Time	—	50	—	ns	V _{CC} = 400V, I _F = 8A, V _{GE} = 15V
I _{rr}	Peak Reverse Recovery Current	—	14	—	A	R _g = 22Ω, L=1.0mH, L _s =150nH

Notes:

- ① V_{CC} = 80% (V_{CES}), V_{GE} = 20V, R_G = 10Ω, L=210μH.
- ② R_θ is measured at T_J of approximately 90°C.
- ③ Refer to AN-1086 for guidelines for measuring V_{(BR)CES} safely.
- ④ Pulse width limited by max. junction temperature.
- ⑤ Values influenced by parasitic L and C in measurement.
- ⑥ f_{sw} = 40KHz, refer to figure 26.

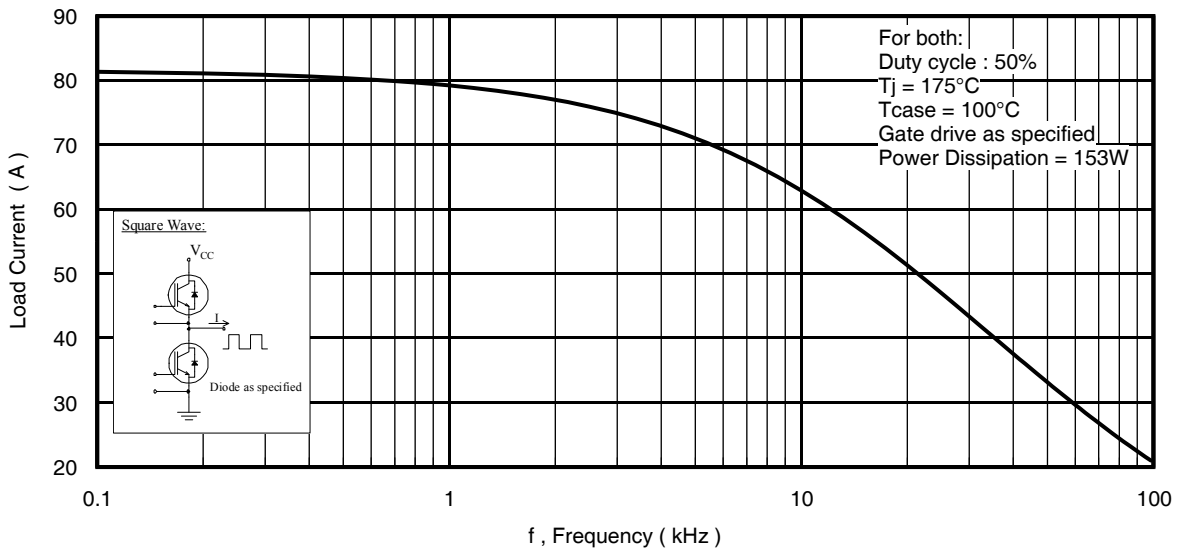

Fig. 1 - Typical Load Current vs. Frequency
(Load Current = I_{RMS} of fundamental)

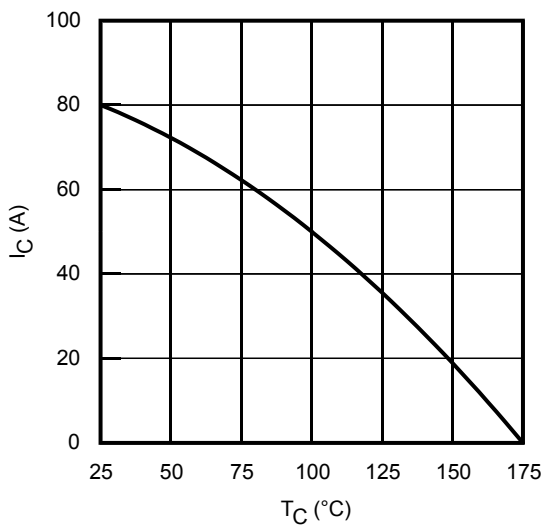

Fig. 2 - Maximum DC Collector Current vs. Case Temperature

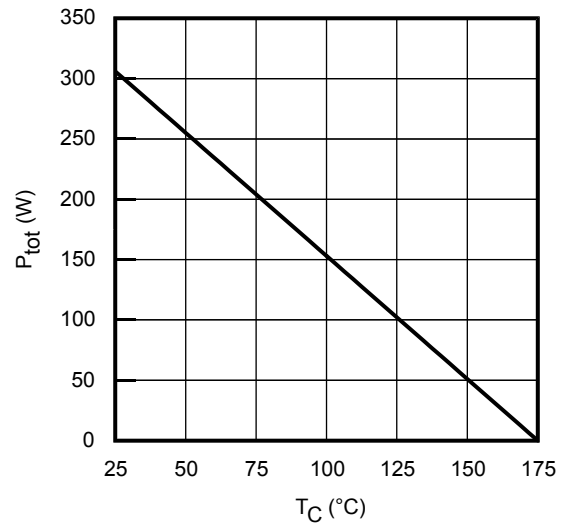

Fig. 3 - Power Dissipation vs. Case Temperature

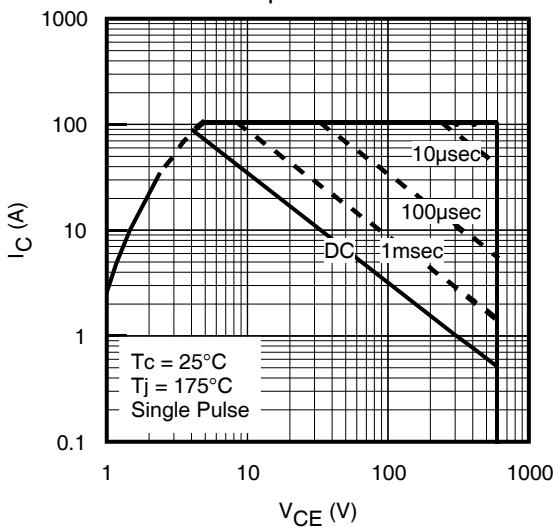

Fig. 4 - Forward SOA
 $T_C = 25^\circ\text{C}$; $T_J \leq 175^\circ\text{C}$; $V_{GE} = 15\text{V}$

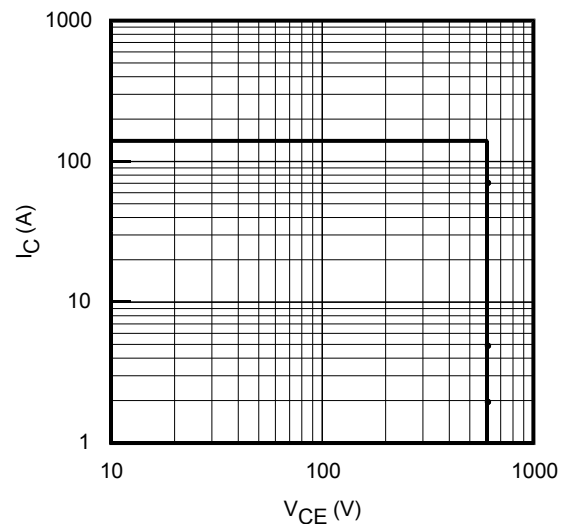

Fig. 5 - Reverse Bias SOA
 $T_J = 175^\circ\text{C}$; $V_{GE} = 20\text{V}$

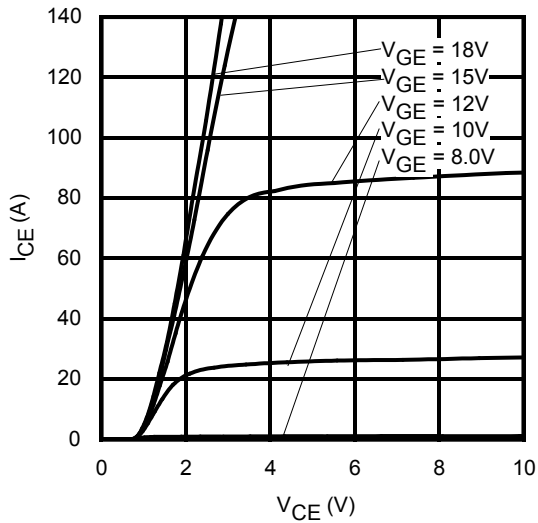

Fig. 6 - Typ. IGBT Output Characteristics
 $T_J = -40^\circ\text{C}$; $t_p = 20\mu\text{s}$

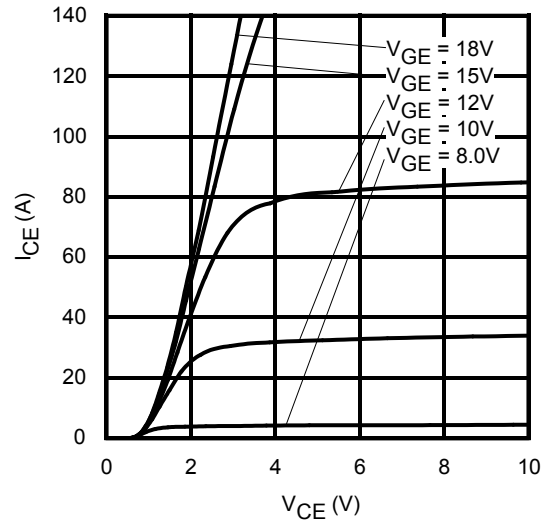

Fig. 7 - Typ. IGBT Output Characteristics
 $T_J = 25^\circ\text{C}$; $t_p = 20\mu\text{s}$

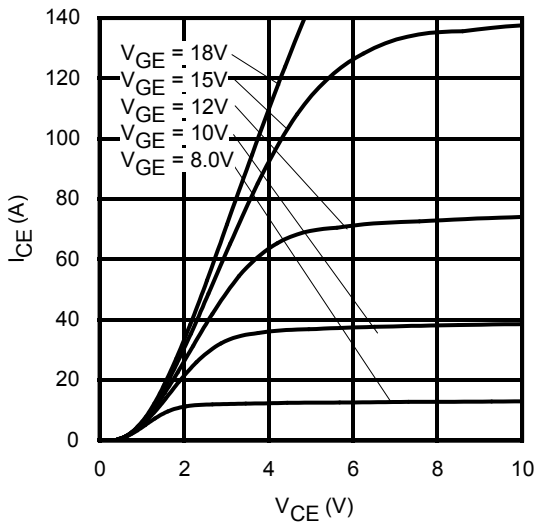

Fig. 8 - Typ. IGBT Output Characteristics
 $T_J = 175^\circ\text{C}$; $t_p = 20\mu\text{s}$

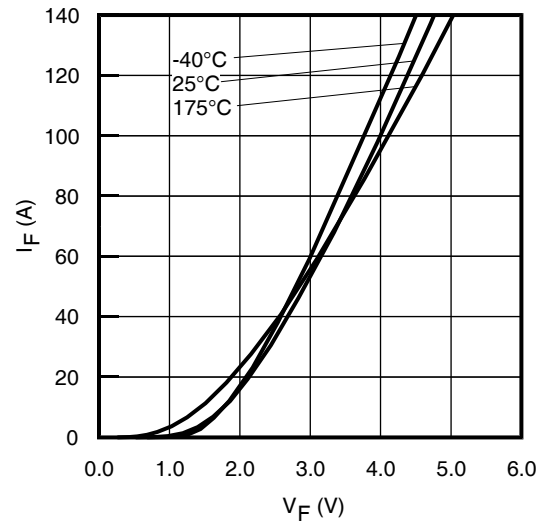

Fig. 9 - Typ. Diode Forward Voltage Drop Characteristics

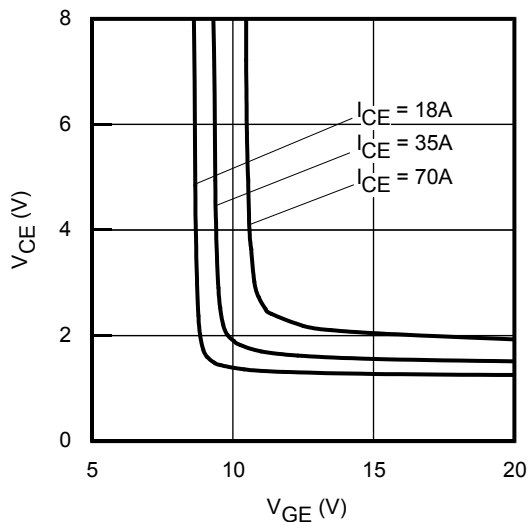

Fig. 10 - Typical V_{CE} vs. V_{GE}
 $T_J = -40^\circ\text{C}$

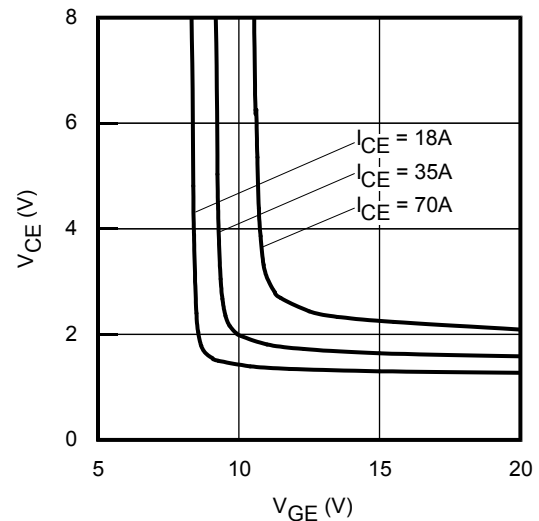

Fig. 11 - Typical V_{CE} vs. V_{GE}
 $T_J = 25^\circ\text{C}$

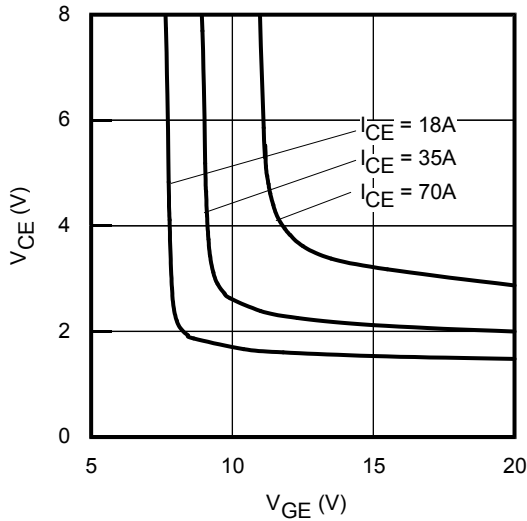

Fig. 12 - Typical V_{CE} vs. V_{GE}
 $T_J = 175^\circ\text{C}$

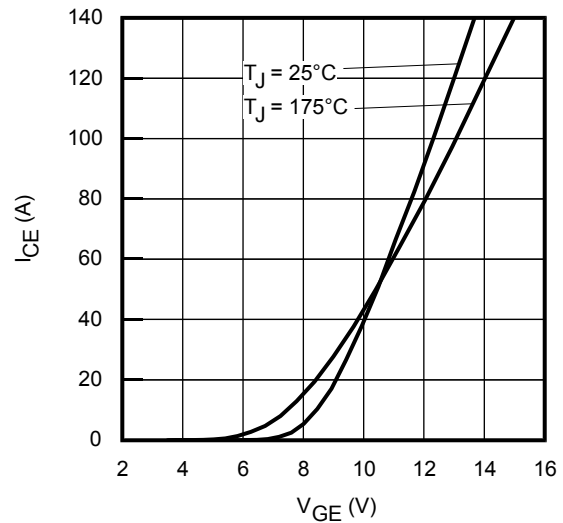

Fig. 13 - Typ. Transfer Characteristics
 $V_{CE} = 50\text{V}$; $t_p = 20\mu\text{s}$

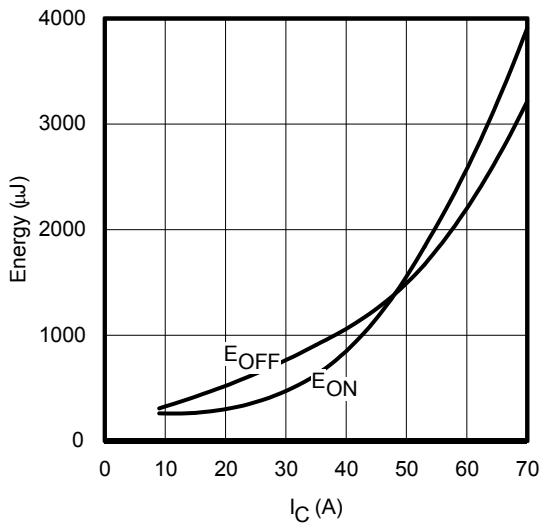

Fig. 14 - Typ. Energy Loss vs. I_C
 $T_J = 175^\circ\text{C}$; $V_{CE} = 400\text{V}$, $R_G = 10\Omega$; $V_{GE} = 15\text{V}$

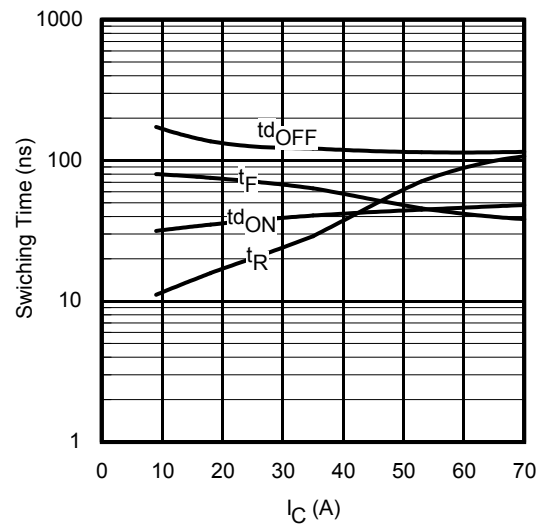

Fig. 15 - Typ. Switching Time vs. I_C
 $T_J = 175^\circ\text{C}$; $V_{CE} = 400\text{V}$, $R_G = 10\Omega$; $V_{GE} = 15\text{V}$

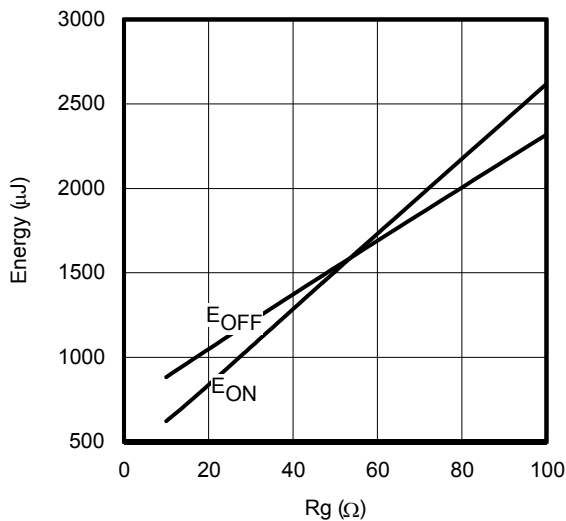

Fig. 16 - Typ. Energy Loss vs. R_G
 $T_J = 175^\circ\text{C}$; $V_{CE} = 400\text{V}$, $I_{CE} = 35\text{A}$; $V_{GE} = 15\text{V}$

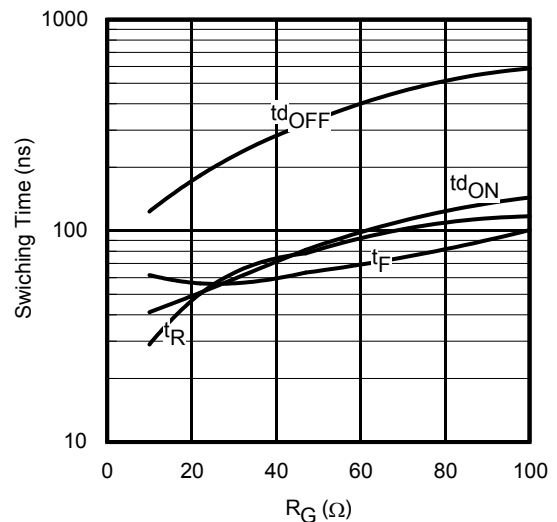

Fig. 17 - Typ. Switching Time vs. R_G
 $T_J = 175^\circ\text{C}$; $V_{CE} = 400\text{V}$, $I_{CE} = 35\text{A}$; $V_{GE} = 15\text{V}$

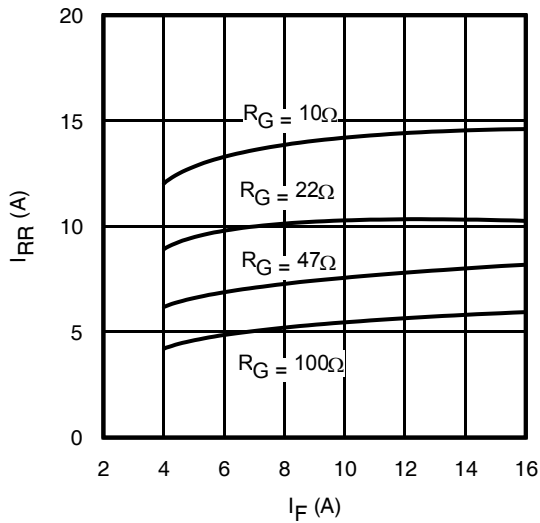

Fig. 18 - Typ. Diode I_{RR} vs. I_F
 $T_J = 175^\circ\text{C}$

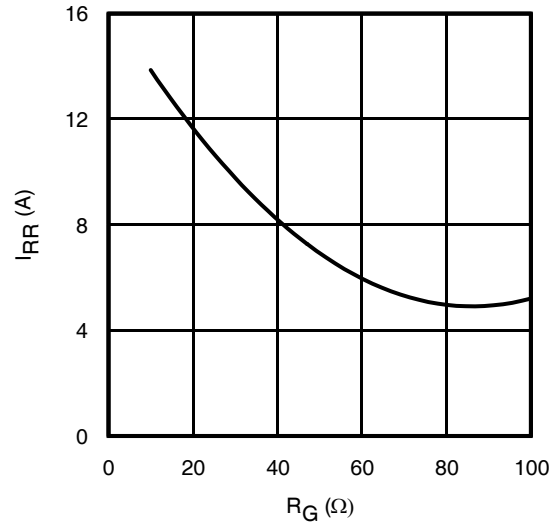

Fig. 19 - Typ. Diode I_{RR} vs. R_G
 $T_J = 175^\circ\text{C}$

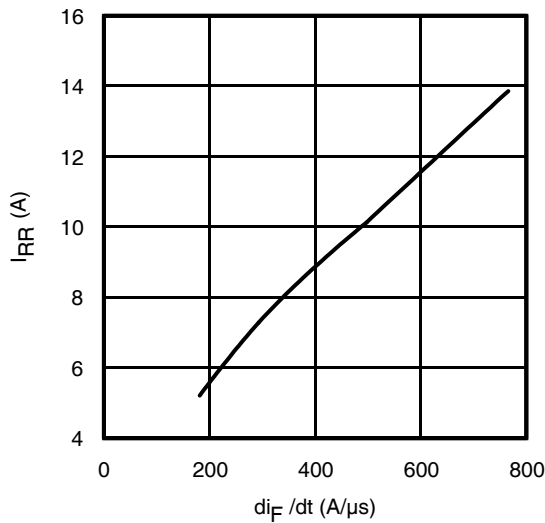

Fig. 20 - Typ. Diode I_{RR} vs. di_F/dt
 $V_{CC} = 400\text{V}$; $V_{GE} = 15\text{V}$; $I_F = 8\text{A}$; $T_J = 175^\circ\text{C}$

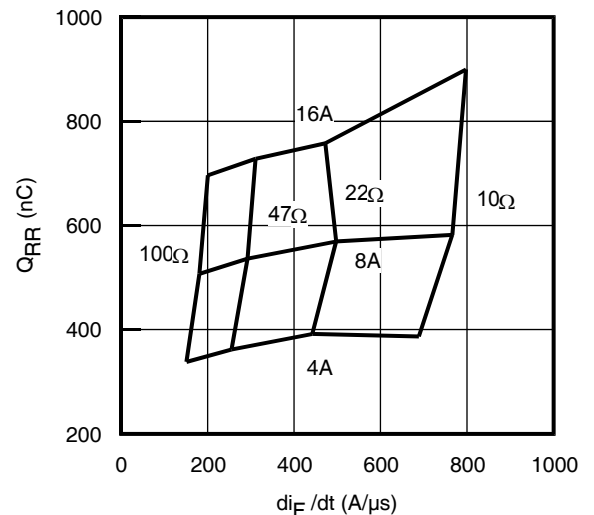

Fig. 21 - Typ. Diode Q_{RR} vs. di_F/dt
 $V_{CC} = 400\text{V}$; $V_{GE} = 15\text{V}$; $T_J = 175^\circ\text{C}$

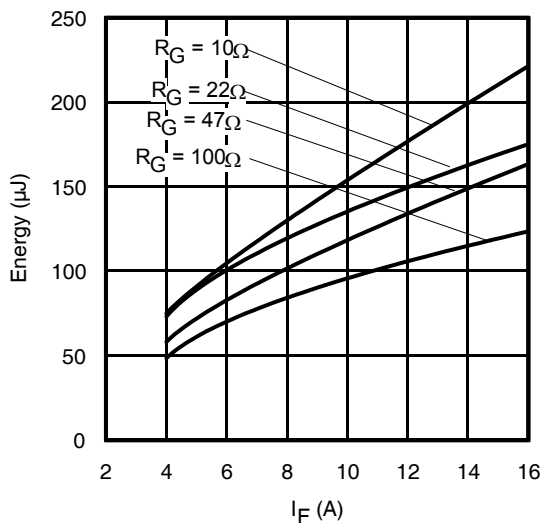

Fig. 22 - Typ. Diode E_{RR} vs. I_F
 $T_J = 175^\circ\text{C}$

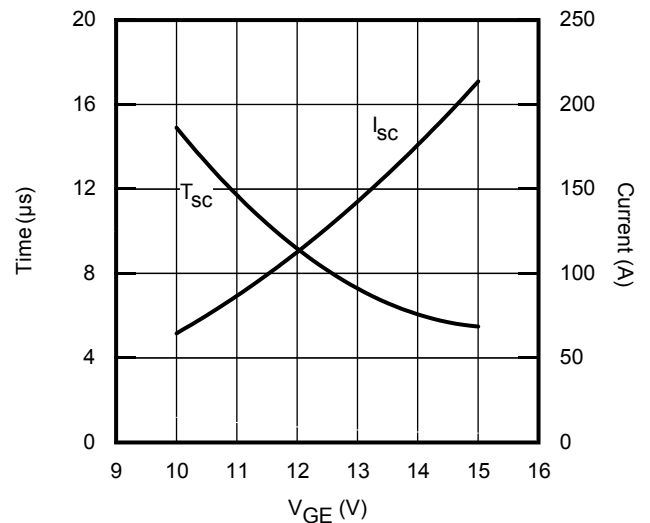

Fig. 23 - V_{GE} vs. Short Circuit Time
 $V_{CC} = 400\text{V}$; $T_C = 150^\circ\text{C}$

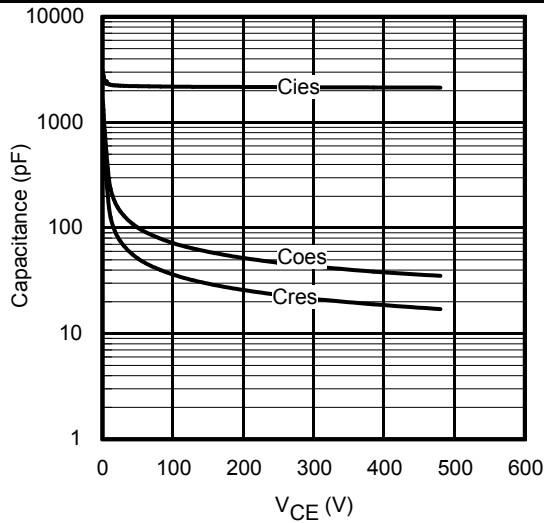

Fig. 24 - Typ. Capacitance vs. V_{CE}
 $V_{GE} = 0V$; $f = 1MHz$

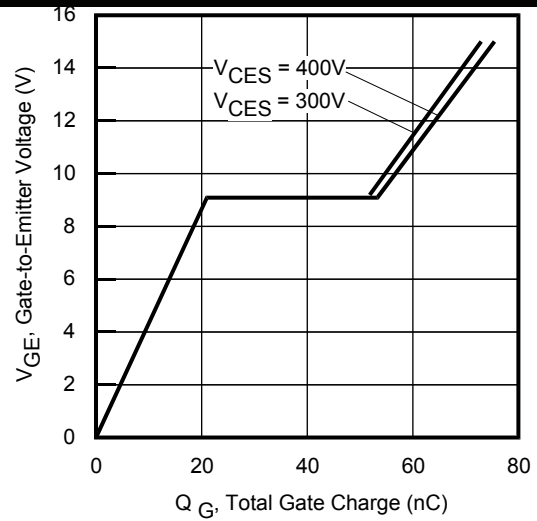

Fig. 25 - Typical Gate Charge vs. V_{GE}
 $I_{CE} = 35A$

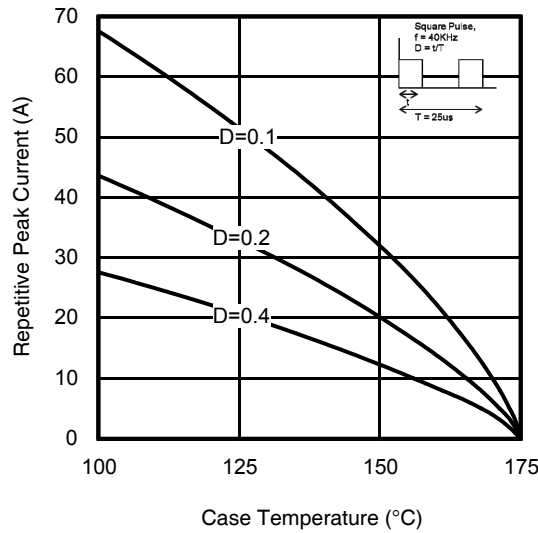

Fig. 26. Maximum Diode Repetitive Forward Peak Current vs. Case Temperature

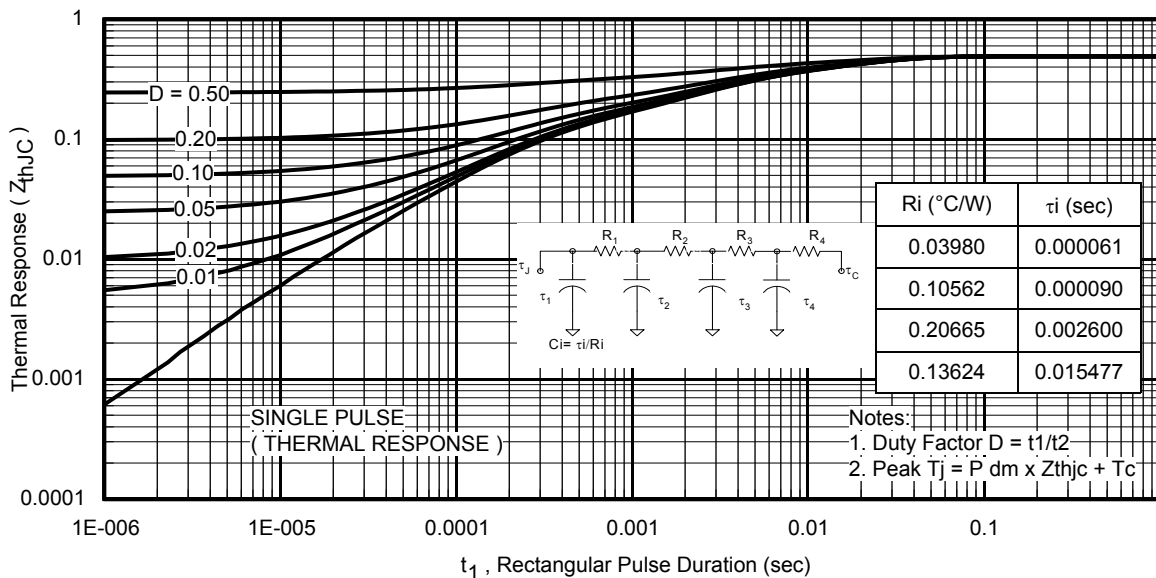

Fig. 27 - Maximum Transient Thermal Impedance, Junction-to-Case (IGBT)

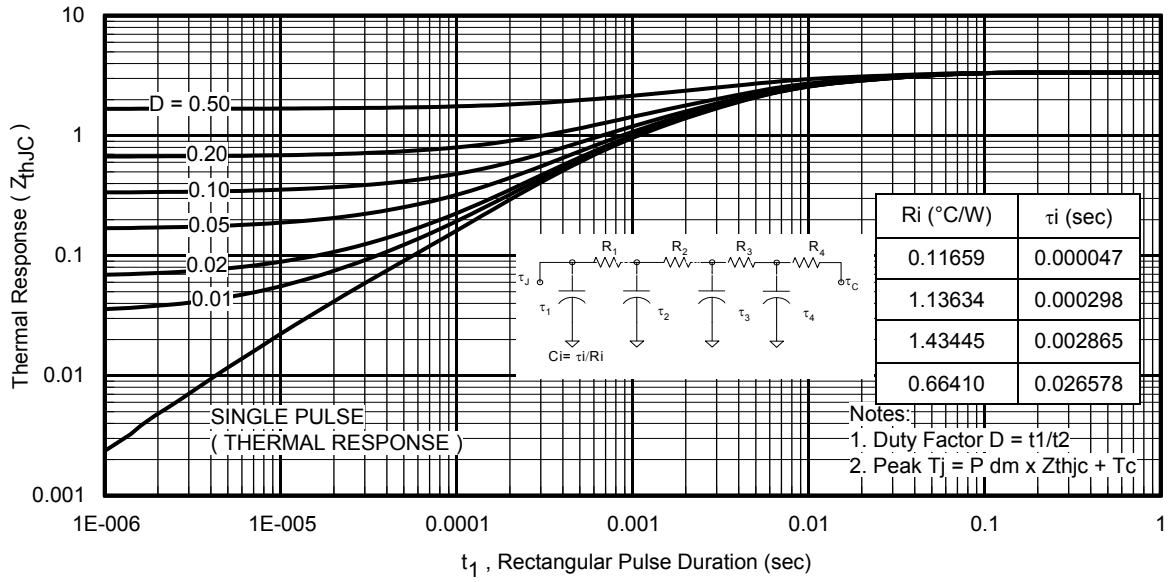

Fig. 28 - Maximum Transient Thermal Impedance, Junction-to-Case (DIODE)

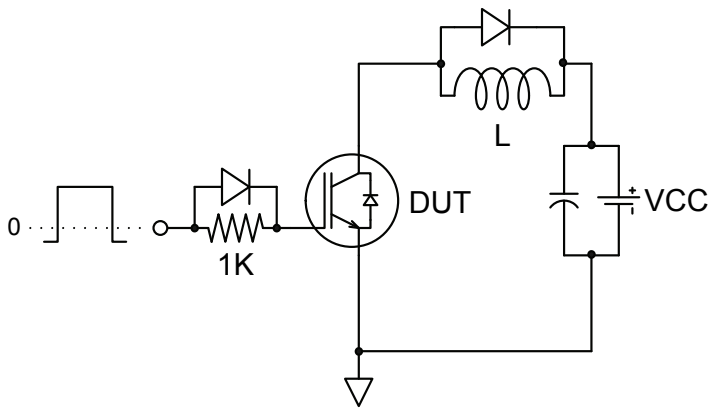

Fig.C.T.1 - Gate Charge Circuit (turn-off)

Fig.C.T.2 - RBSOA Circuit

Fig.C.T.3 - S.C. SOA Circuit

Fig.C.T.4 - Switching Loss Circuit

Fig.C.T.5 - Resistive Load Circuit

Fig.C.T.6 - BVCES Filter Circuit

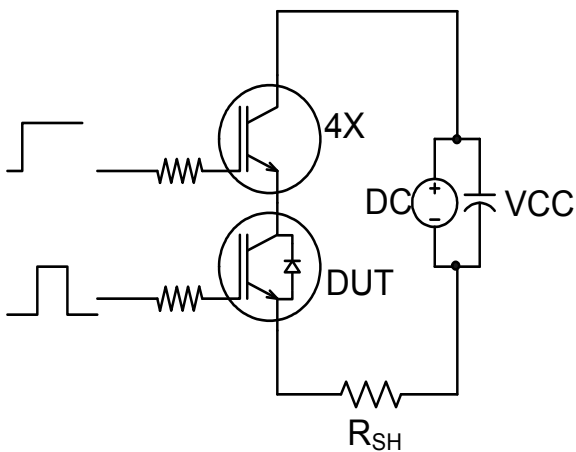
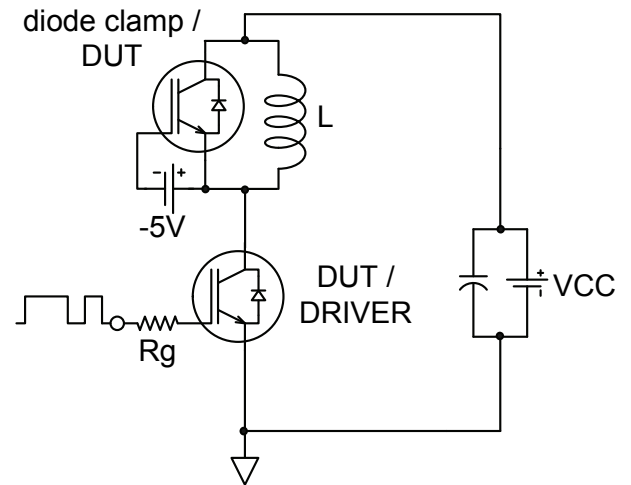
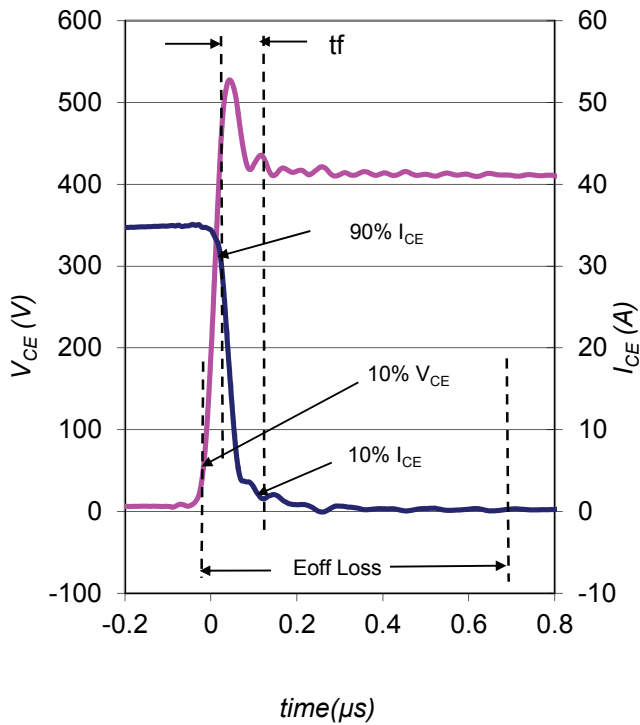

Fig. WF1 - Typ. Turn-off Loss Waveform
@ $T_J = 175^\circ\text{C}$ using Fig. CT.4

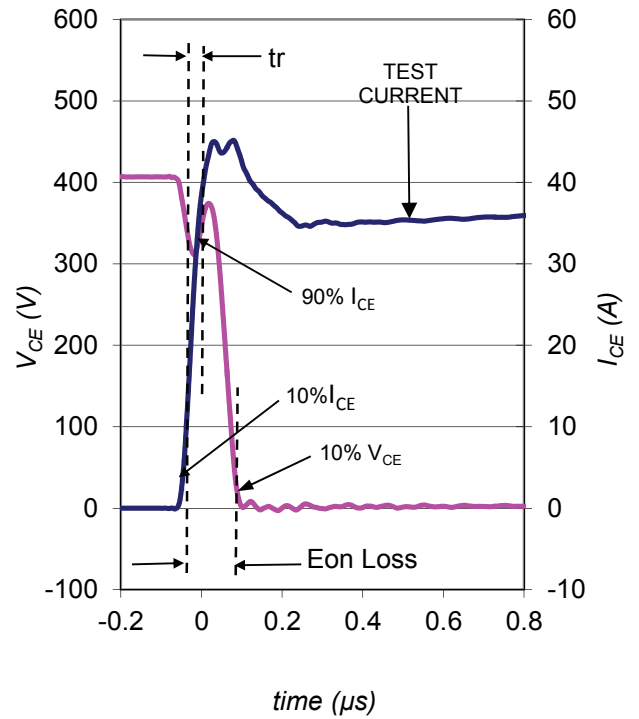

Fig. WF2 - Typ. Turn-on Loss Waveform
@ $T_J = 175^\circ\text{C}$ using Fig. CT.4

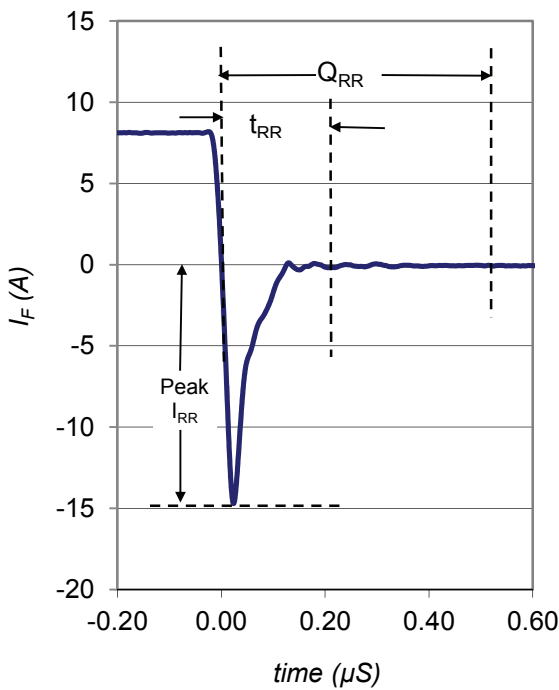

Fig. WF3 - Typ. Diode Recovery Waveform
@ $T_J = 175^\circ\text{C}$ using Fig. CT.4

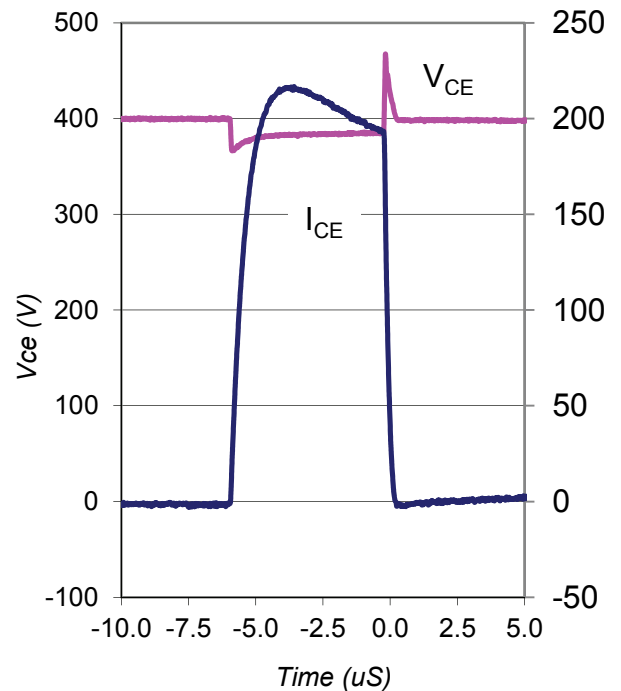
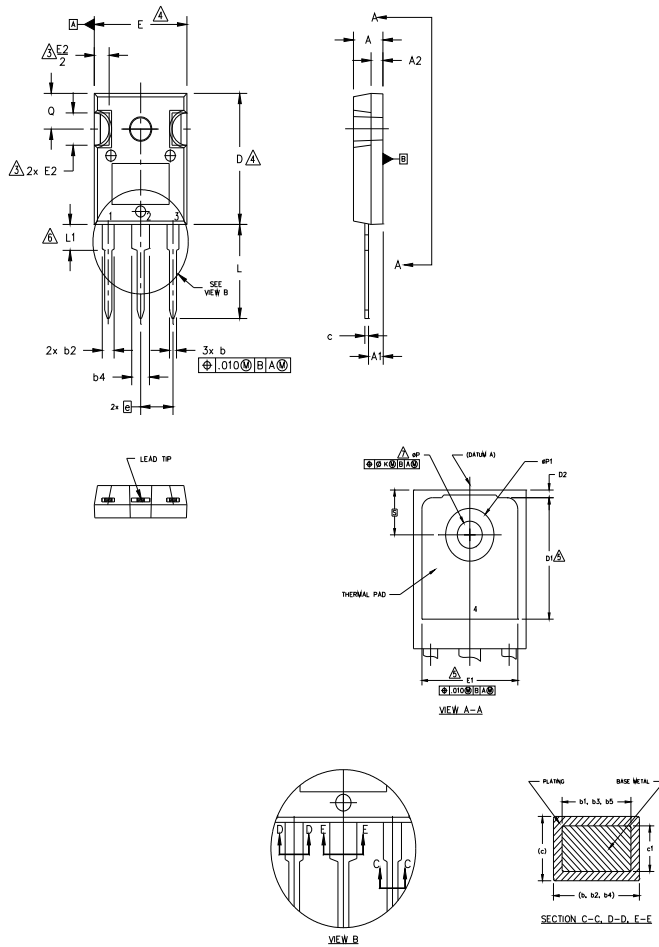

Fig. WF4 - Typ. S.C. Waveform
@ $T_J = 150^\circ\text{C}$ using Fig. CT.3

TO-247AC Package Outline

Dimensions are shown in millimeters (inches)



NOTES:

1. DIMENSIONING AND TOLERANCING AS PER ASME Y14.5M 1994.
2. DIMENSIONS ARE SHOWN IN INCHES.
3. CONTOUR OF SLOT OPTIONAL.
4. DIMENSION D & E DO NOT INCLUDE MOLD FLASH. MOLD FLASH SHALL NOT EXCEED .005" (0.127) PER SIDE. THESE DIMENSIONS ARE MEASURED AT THE OUTERMOST EXTREMES OF THE PLASTIC BODY.
5. THERMAL PAD CONTOUR OPTIONAL WITHIN DIMENSIONS D1 & E1.
6. LEAD FINISH UNCONTROLLED IN L1.
7. ϕP TO HAVE A MAXIMUM DRAFT ANGLE OF 1.5° TO THE TOP OF THE PART WITH A MAXIMUM HOLE DIAMETER OF .154 INCH.
8. OUTLINE CONFORMS TO JEDEC OUTLINE TO-247AC .

SYMBOL	DIMENSIONS				NOTES
	INCHES		MILLIMETERS		
	MIN.	MAX.	MIN.	MAX.	
A	.183	.209	4.65	5.31	
A1	.087	.102	2.21	2.59	
A2	.059	.098	1.50	2.49	
b	.039	.055	0.99	1.40	
b1	.039	.053	0.99	1.35	
b2	.065	.094	1.65	2.39	
b3	.065	.092	1.65	2.34	
b4	.102	.135	2.59	3.43	
b5	.102	.133	2.59	3.38	
c	.015	.035	0.38	0.89	
c1	.015	.033	0.38	0.84	
D	.776	.815	19.71	20.70	4
D1	.515	-	13.08	-	5
D2	.020	.053	0.51	1.35	
E	.602	.625	15.29	15.87	4
E1	.530	-	13.46	-	
E2	.178	.216	4.52	5.49	
e	.215 BSC		5.46 BSC		
ϕk	.010		0.25		
L	.559	.634	14.20	16.10	
L1	.146	.169	3.71	4.29	
ϕP	.140	.144	3.56	3.66	
$\phi P1$	-	.291	-	7.39	
Q	.209	.224	5.31	5.69	
S	.217 BSC		5.51 BSC		

LEAD ASSIGNMENTS

HEXFET

- 1.- GATE
- 2.- DRAIN
- 3.- SOURCE
- 4.- DRAIN

IGBTs, CoPACK

- 1.- GATE
- 2.- COLLECTOR
- 3.- EMITTER
- 4.- COLLECTOR

DIODES

- 1.- ANODE/OPEN
- 2.- CATHODE
- 3.- ANODE

TO-247AC Part Marking Information

Notes: This part marking information applies to devices produced after 02/26/2001

EXAMPLE: THIS IS AN IRFPE30
WITH ASSEMBLY
LOT CODE 5657
ASSEMBLED ON WW 35, 2001
IN THE ASSEMBLY LINE "H"

Note: "P" in assembly line position
indicates "Lead-Free"

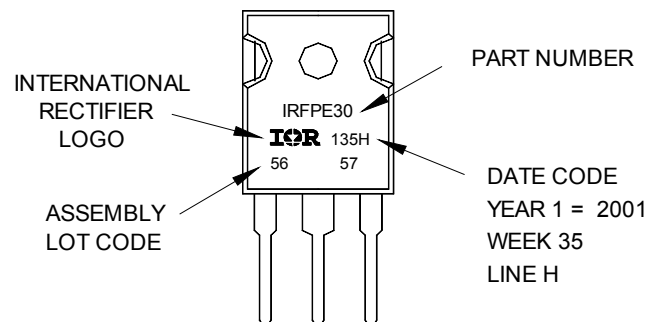

TO-247AC package is not recommended for Surface Mount Application.

Note: For the most current drawing please refer to IR website at <http://www.irf.com/package/>

TO-247AD Package Outline

Dimensions are shown in millimeters (inches)

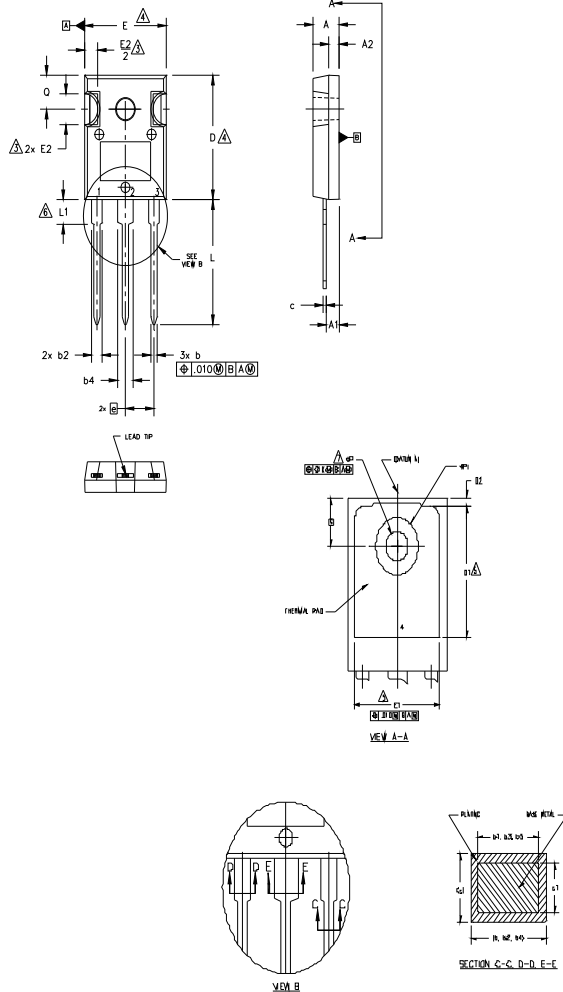

NOTES:

1. DIMENSIONING AND TOLERANCING AS PER ASME Y14.5M 1994.
2. DIMENSIONS ARE SHOWN IN INCHES.
3. CONTOUR OF SLOT OPTIONAL.
4. DIMENSION D & E DO NOT INCLUDE MOLD FLASH. MOLD FLASH SHALL NOT EXCEED .005" (0.127) PER SIDE. THESE DIMENSIONS ARE MEASURED AT THE OUTERMOST EXTREMES OF THE PLASTIC BODY.
5. THERMAL PAD CONTOUR OPTIONAL WITHIN DIMENSIONS D1 & E1.
6. LEAD FINISH UNCONTROLLED IN L1.
7. ØP TO HAVE A MAXIMUM DRAFT ANGLE OF 1.5 ° TO THE TOP OF THE PART WITH A MAXIMUM HOLE DIAMETER OF .154 INCH.
8. OUTLINE CONFORMS TO JEDEC OUTLINE TO-247AD.

SYMBOL	DIMENSIONS				NOTES
	INCHES		MILLIMETERS		
	MIN.	MAX.	MIN.	MAX.	
A	.183	.209	4.65	5.31	
A1	.087	.102	2.21	2.59	
A2	.059	.098	1.50	2.49	
b	.039	.056	0.99	1.40	
b1	.039	.053	0.99	1.35	
b2	.065	.094	1.65	2.39	
b3	.065	.092	1.65	2.34	
b4	.102	.135	2.59	3.43	
b5	.102	.133	2.59	3.38	
c	.015	.036	0.38	0.89	
c1	.015	.033	0.38	0.84	
D	.776	.815	19.71	20.70	4
D1	.515	-	13.08	-	5
D2	.020	.053	0.51	1.35	
E	.602	.625	15.29	15.87	4
E1	.530	-	13.46	-	
E2	.178	.216	4.52	5.49	
e	.215 BSC		5.46 BSC		
Øk	.010		0.25		
L	.780	.827	19.57	21.00	
L1	.146	.169	3.71	4.29	
ØP	.140	.144	3.56	3.66	
ØP1	-	.291	-	7.39	
Q	.209	.224	5.31	5.69	
S	.217 BSC		5.51 BSC		

LEAD ASSIGNMENTS

HEXFET

- 1.- GATE
- 2.- DRAIN
- 3.- SOURCE
- 4.- DRAIN

IGBTs, CgPACK

- 1.- GATE
- 2.- COLLECTOR
- 3.- EMITTER
- 4.- COLLECTOR

DIODES

- 1.- ANODE/OPEN
- 2.- CATHODE
- 3.- ANODE

TO-247AD Part Marking Information

EXAMPLE: THIS IS AN IRGP30B120KD-E
WITH ASSEMBLY
LOT CODE 5657
ASSEMBLED ON WW 35, 2000
IN THE ASSEMBLY LINE "H"

Note: "P" in assembly line position
indicates "Lead-Free"

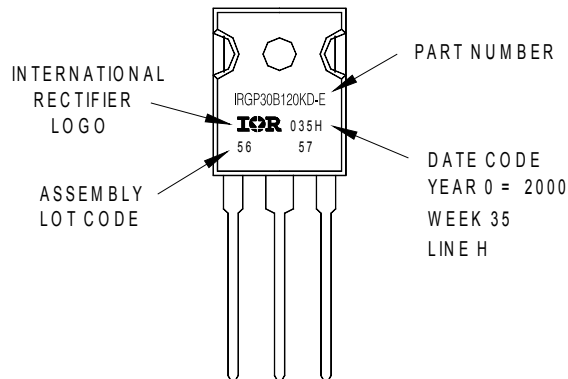

TO-247AD package is not recommended for Surface Mount Application.

Note: For the most current drawing please refer to IR website at <http://www.irf.com/package/>

Qualification Information[†]

Qualification Level	Industrial (per JEDEC JESD47F) ^{††}	
Moisture Sensitivity Level	TO-247AC	N/A
	TO-247AD	
RoHS Compliant	Yes	

† Qualification standards can be found at International Rectifier's web site: <http://www.irf.com/product-info/reliability/>

†† Applicable version of JEDEC standard at the time of product release.

Revision History

Date	Comments
11/14/2014	<ul style="list-style-type: none"> • Added I_{FM} Diode Maximum Forward Current = 140A with the note ④ on page 1. • Removed note ④ from switching losses test condition on page 2.