

2 CO forcibly guided contacts relay interface modules, 15.8 mm wide

Type 48.12

- 2 CO 8 A
- Screw terminals
- Relay with forcibly guided contacts according to EN 50205 Type B
- 35 mm rail (EN 60715) mounting
- Cadmium-free contact material

48.12
Screw terminal



48.12



- 2 CO 8 A
- Forcibly guided contacts relay
- Screw terminals

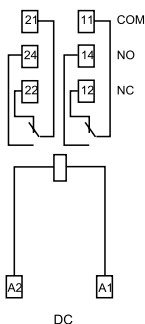

According to EN 50205 only 1 NO and 1 NC (11-14 and 21-22 or 11-12 and 21-24) shall be used as forcibly guided contacts.

For outline drawing see page 9

Contact specification

Contact configuration		2 CO (DPDT)
Rated current/Maximum peak current	A	8/15
Rated voltage/Maximum switching voltage	V AC	250/400
Rated load AC1	VA	2000
Rated load AC15 (230 V AC)	VA	500
Single phase motor rating (230 V AC)	kW	0.37
Breaking capacity DC1: 30/110/220 V	A	8/0.65/0.2
Minimum switching load	mW (V/mA)	500 (10/10)
Standard contact material		AgNi

Coil specification

Nominal voltage (U _N)	V AC (50/60 Hz)	—
	V DC	12 - 24
Rated power AC/DC	VA (50 Hz)/W	—/0.7
Operating range	AC	—
	DC	(0.75...1.2)U _N
Holding voltage	AC/DC	—/0.4 U _N
Must drop-out voltage	AC/DC	—/0.1 U _N

Technical data

Mechanical life AC/DC	cycles	—/10 · 10 ⁶
Electrical life at rated load AC1	cycles	100 · 10 ³
Operate/release time	ms	10/4
Insulation between coil and contacts (1.2/50 µs)	kV	6 (8 mm)
Dielectric strength between open contacts	V AC	1500
Ambient temperature range	°C	-40...+70
Protection category		IP 20

Approvals relay (according to type)



B

**1 CO relay interface modules,
15.8 mm wide**
Ideal interface for PLC and electronic systems

Type 48.P3

- 1 CO 10 A
- Push-in terminals

Type 48.31

- 1 CO 10 A
- Screw terminals

- AC coils or DC sensitive coils
- Supply status indication and EMC coil suppression module as standard
- Identification label
- UL Listing (certain relay/socket combinations)
- 35 mm rail (EN 60715) mounting
- Cadmium-free contact material

48.P3
Push-in terminal



48.31
Screw terminal



NEW 48.P3



- 1 CO 10 A
- Push-in terminals

48.31

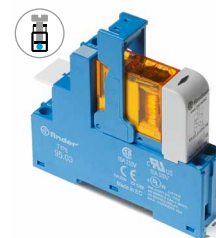

- 1 CO 10 A
- Screw terminals

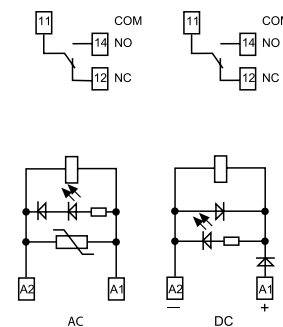
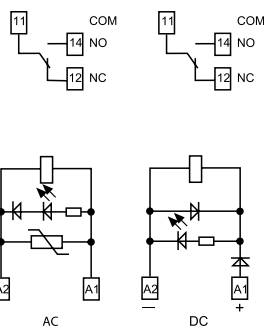

For outline drawing see page 9

Contact specification

Contact configuration		1 CO (SPDT)	1 CO (SPDT)
Rated current/Maximum peak current	A	10/20	10/20
Rated voltage/ Maximum switching voltage	V AC	250/400	250/400
Rated load AC1	VA	2500	2500
Rated load AC15 (230 V AC)	VA	500	500
Single phase motor rating (230 V AC)	kW	0.37	0.37
Breaking capacity DC1: 30/110/220 V	A	10/0.3/0.12	10/0.3/0.12
Minimum switching load	mW (V/mA)	300 (5/5)	300 (5/5)
Standard contact material		AgNi	AgNi

Coil specification

Nominal voltage (U _N)	V AC (50/60 Hz)	12 - 24 - 110 - 120 - 230	12 - 24 - 110 - 120 - 230
	V DC	12 - 24 - 125	12 - 24 - 125
Rated power AC/sens. DC	VA (50 Hz)/W	1.2/0.5	1.2/0.5
Operating range	AC	(0.8...1.1)U _N	(0.8...1.1)U _N
	sens. DC	(0.73...1.5)U _N	(0.73...1.5)U _N
Holding voltage	AC/DC	0.8 U _N / 0.4 U _N	0.8 U _N / 0.4 U _N
Must drop-out voltage	AC/DC	0.2 U _N / 0.1 U _N	0.2 U _N / 0.1 U _N

Technical data

Mechanical life	cycles	10 · 10 ⁶	10 · 10 ⁶
Electrical life at rated load AC1	cycles	200 · 10 ³	200 · 10 ³
Operate/release time	ms	7/4 (AC) - 12/12 (DC)	7/4 (AC) - 12/12 (DC)
Insulation between coil and contacts (1.2/50 μs)	kV	6 (8 mm)	6 (8 mm)
Dielectric strength between open contacts	V AC	1000	1000
Ambient temperature range	°C	-40...+70	-40...+70
Protection category		IP 20	IP 20

Approvals relay (according to type)



**2 CO relay interface modules,
15.8 mm wide**
Ideal interface for PLC and electronic systems

Type 48.P5

- 2 CO 8 A
- Push-in terminals

Type 48.52

- 2 CO 8 A
- Screw terminals

- AC coils or DC sensitive coils
- Supply status indication and EMC coil suppression module as standard
- Identification label
- UL Listing (certain relay/socket combinations)
- 35 mm rail (EN 60715) mounting
- Cadmium-free contact material

48.P5

Push-in terminal



48.52

Screw terminal



For outline drawing see page 9

Contact specification

Contact configuration		2 CO (DPDT)	2 CO (DPDT)
Rated current/Maximum peak current	A	8/15	8/15
Rated voltage/ Maximum switching voltage	V AC	250/250	250/250
Rated load AC1	VA	2000	2000
Rated load AC15 (230 V AC)	VA	400	400
Single phase motor rating (230 V AC)	kW	0.3	0.3
Breaking capacity DC1: 30/110/220 V	A	8/0.3/0.12	8/0.3/0.12
Minimum switching load	mW (V/mA)	300 (5/5)	300 (5/5)
Standard contact material		AgNi	AgNi

Coil specification

Nominal voltage (U_N)	V AC (50/60 Hz)	12 - 24 - 110 - 120 - 230	12 - 24 - 110 - 120 - 230
	V DC	12 - 24 - 125	12 - 24 - 125
Rated power AC/sens. DC	VA (50 Hz)/W	1.2/0.5	1.2/0.5
Operating range	AC	$(0.8 \dots 1.1) U_N$	$(0.8 \dots 1.1) U_N$
	sens. DC	$(0.73 \dots 1.5) U_N$	$(0.73 \dots 1.5) U_N$
Holding voltage	AC/DC	$0.8 U_N / 0.4 U_N$	$0.8 U_N / 0.4 U_N$
Must drop-out voltage	AC/DC	$0.2 U_N / 0.1 U_N$	$0.2 U_N / 0.1 U_N$

Technical data

Mechanical life	cycles	$10 \cdot 10^6$	$10 \cdot 10^6$
Electrical life at rated load AC1	cycles	$100 \cdot 10^3$	$100 \cdot 10^3$
Operate/release time	ms	7/4 (AC) - 12/12 (DC)	7/4 (AC) - 12/12 (DC)
Insulation between coil and contacts (1.2/50 μ s)	kV	6 (8 mm)	6 (8 mm)
Dielectric strength between open contacts	V AC	1000	1000
Ambient temperature range	$^{\circ}$ C	-40...+70	-40...+70
Protection category		IP 20	IP 20

Approvals relay (according to type)

NEW 48.P5

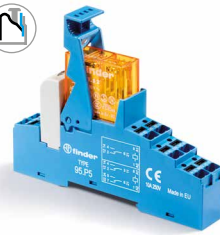

- 2 CO 8 A
- Push-in terminals

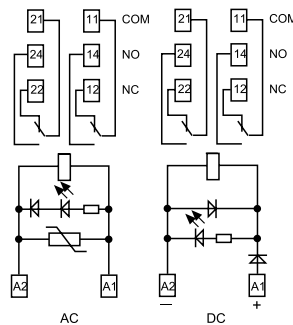

48.52

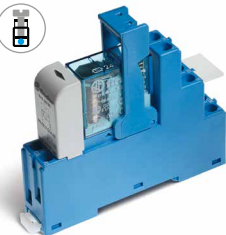

- 2 CO 8 A
- Screw terminals

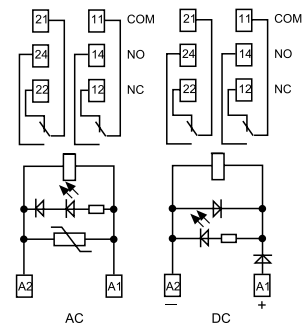

**1 CO relay interface modules,
15.8 mm wide**
Ideal interface for PLC and electronic systems

Type 48.P6

- 1 CO 16 A
- Push-in terminals

Type 48.61

- 1 CO 16 A
- Screw terminals

- AC coils or DC sensitive coils
- Supply status indication and EMC coil suppression module as standard
- Identification label
- UL Listing (certain relay/socket combinations)
- 35 mm rail (EN 60715) mounting
- Cadmium-free contact material available

48.P6
Push-in terminal



48.61
Screw terminal



For outline drawing see page 9

Contact specification

Contact configuration		1 CO (SPDT)
Rated current/Maximum peak current	A	16*/30
Rated voltage/Maximum switching voltage	V AC	250/400
Rated load AC1	VA	4000
Rated load AC15 (230 V AC)	VA	750
Single phase motor rating (230 V AC)	kW	0.55
Breaking capacity DC1: 30/110/220 V	A	16/0.3/0.12
Minimum switching load	mW (V/mA)	500 (10/5)
Standard contact material		AgCdO

Coil specification

Nominal voltage (U _N)	V AC (50/60 Hz)	12 - 24 - 110 - 120 - 230
	V DC	12 - 24 - 125
Rated power AC/sens. DC	VA (50 Hz)/W	1.2/0.5
Operating range	AC	(0.8...1.1)U _N
	sens. DC	(0.8...1.5)U _N
Holding voltage	AC/DC	0.8 U _N / 0.4 U _N
Must drop-out voltage	AC/DC	0.2 U _N / 0.1 U _N

Technical data

Mechanical life	cycles	10 · 10 ⁶
Electrical life at rated load AC1	cycles	100 · 10 ³
Operate/release time	ms	7/4 (AC) - 12/12 (DC)
Insulation between coil and contacts (1.2/50 μs)	kV	6 (8 mm)
Dielectric strength between open contacts	V AC	1000
Ambient temperature range	°C	-40...+70
Protection category		IP 20

Approvals relay (according to type)

NEW 48.P6

- 1 CO 16 A
- Push-in terminals

48.61

- 1 CO 16 A
- Screw terminals

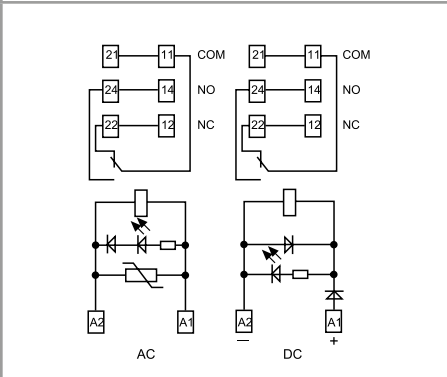

* For currents > 10 A, contact terminals must be connected in parallel (21 with 11, 24 with 14, 22 with 12).

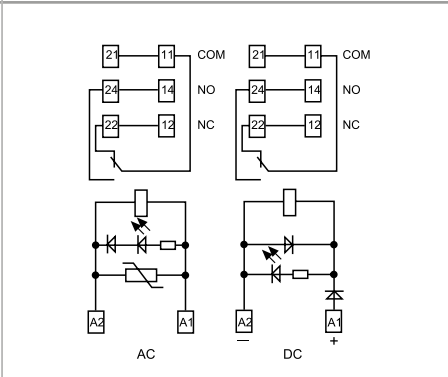

* For currents > 10 A, contact terminals must be connected in parallel (21 with 11, 24 with 14, 22 with 12).



**2 CO relay interface modules,
15.8 mm wide**
Ideal interface for PLC and electronic systems

Type 48.P8

- 2 CO 10 A
- Push-in terminals

Type 48.62

- 2 CO 10 A
- Screw terminals

- DC sensitive coils
- Supply status indication and EMC coil suppression module as standard
- Identification label
- UL Listing (certain relay/socket combinations)
- 35 mm rail (EN 60715) mounting
- Cadmium-free contact material

48.P8
Push-in terminal



48.62
Screw terminal



For outline drawing see page 9

Contact specification

Contact configuration		2 CO (DPDT)	2 CO (DPDT)
Rated current/Maximum peak current	A	10/20	10/20
Rated voltage/ Maximum switching voltage	V AC	250/400	250/400
Rated load AC1	VA	2500	2500
Rated load AC15 (230 V AC)	VA	500	500
Single phase motor rating (230 V AC)	kW	0.37	0.37
Breaking capacity DC1: 30/110/220 V	A	10/0.3/0.12	10/0.3/0.12
Minimum switching load	mW (V/mA)	300 (5/5)	300 (5/5)
Standard contact material		AgNi	AgNi

Coil specification

Nominal voltage (U_N)	V AC (50/60 Hz)	—	—
	V DC	12 - 24 - 125	12 - 24 - 125
Rated power AC/sens. DC	VA (50 Hz)/W	—/0.5	—/0.5
Operating range	AC	—	—
	sens. DC	$(0.8 \dots 1.5)U_N$	$(0.8 \dots 1.5)U_N$
Holding voltage	AC/DC	—/0.4 U_N	—/0.4 U_N
Must drop-out voltage	AC/DC	—/0.1 U_N	—/0.1 U_N

Technical data

Mechanical life	cycles	$20 \cdot 10^6$	$20 \cdot 10^6$
Electrical life at rated load AC1	cycles	$100 \cdot 10^3$	$100 \cdot 10^3$
Operate/release time	ms	12/12 (DC)	12/12 (DC)
Insulation between coil and contacts (1.2/50 μ s)	kV	6 (8 mm)	6 (8 mm)
Dielectric strength between open contacts	V AC	1000	1000
Ambient temperature range	$^{\circ}$ C	-40...+70	-40...+70
Protection category		IP 20	IP 20

Approvals relay (according to type)

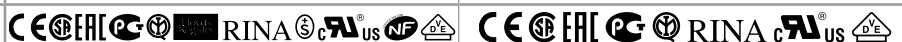

NEW 48.P8

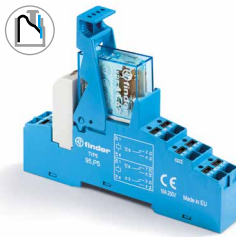

- 2 CO 10 A
- Push-in terminals

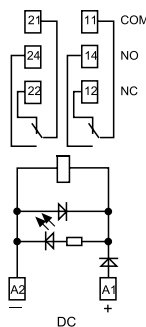

48.62

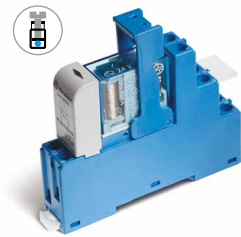

- 2 CO 10 A
- Screw terminals

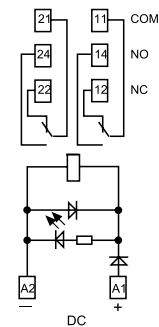

Ordering information

Example: 48 series, 35 mm rail (EN 60715) mount, Push-in terminal relay interface module, 2 CO 8 A contacts, 24 V sensitive DC coil, green LED + diode, 99.02 coil indication.

B

4

8

.

P

5

.

7

.

0

2

4

.

0

0

5

0

Series

Type

Screw terminal

- 1 = 35 mm rail (EN 60715) mount, forcibly guided contacts relay
- 3 = 35 mm rail (EN 60715) mount
- 5 = 35 mm rail (EN 60715) mount
- 6 = 35 mm rail (EN 60715) mount

Push-in terminal

- P = 35 mm rail (EN 60715) mount

Type

Screw terminal

- 1 = for 48.31, 10 A
48.61, 16 A
- 2 = for 48.12 (DC only), 48.52, 8 A
48.62 (DC only), 10 A

Push-in terminal

- 3 = for 48.P3, 10 A
- 5 = for 48.P5, 8 A
- 6 = for 48.P6, 16 A
- 8 = for 48.P8 (DC only), 10 A

Coil version

- 7 = Sensitive DC
- 8 = AC (50/60 Hz)
- 9 = DC (for 48.12 only)

Coil voltage

See coil specifications

A: Contact material

- 0 = Standard AgNi for 48.P3/P5/P8/31/52/62 AgCdO, Standard for 48.P6/61
- 1 = AgNi, for 48.12
- 4 = AgSnO₂, for 48.P6/P8/61/62 only
- 5 = AgNi + Au, for 48.P3/P5/31/52 only

B: Contact circuit

- 0 = CO (nPDT)

D: Special versions

- 0 = Standard
- 2 = Standard (for 48.12 only)

C: Options

- 0 = Standard (for 48.12 only)
- 5 = Standard for DC: green LED + diode (polarity +A1)
- 6 = Standard for AC: green LED + Varistor

Selecting features and options: only combinations in the same row are possible.
Preferred selections for best availability are shown in **bold**.

Type	Coil version	A	B	C	D
48.12	DC	1	0	0	2
48.P3/P5/31/52	AC	0 - 5	0	6	0
48.P3/P5/31/52	Sensitive DC	0 - 5	0	5	0
48.P6/61	AC	0 - 4	0	6	0
48.P6/61	Sensitive DC	0 - 4	0	5	0
48.P8/62	Sensitive DC	0 - 4	0	5	0

Technical data

Insulation		48.12/31/61/P3/P6	48.52/P5	48.12/31/61/62/P3/P6/P8	
Insulation according to EN 61810-1	insulation rated voltage	V 250	250	400	
	rated impulse withstand voltage	kV 4	4	4	
	pollution degree	3	2	2	
	overvoltage category	III	III	III	
Insulation between coil and contacts (1.2/50 μs)		kV 6 (8 mm)			
Dielectric strength between open contacts		V AC 1000; 1500 (48.12)			
Dielectric strength between adjacent contacts		V AC 2000 (48.P5/52); 2500 (48.12/P6)			
Conducted disturbance immunity					
Burst (5...50)ns, 5 kHz, on A1 - A2		EN 61000-4-4		level 4 (4 kV)	
Surge (1.2/50 μs) on A1 - A2 (differential mode)		EN 61000-4-5		level 3 (2 kV)	
Other data					
Bounce time: NO/NC		ms 2/5; 2/10 (48.12)			
Vibration resistance (10...200)Hz: NO/NC		g 20/5 (for 1 pole)		15/3; 20/6 (48.12) for 2 pole	
Power lost to the environment	without contact current	W 0.7			
	with rated current	W 1.2 (48.12/31/P3)	1.3 (48.52/P5)	1.2 (48.61/62/P6/P8)	
Wire strip length		mm 8			
Screw torque (only for 48.12/31/52/61/81)		Nm 0.5			
Max. wire size		Screw terminal		Push-in terminal	
		solid cable	stranded cable	solid cable	stranded cable
	mm ²	1 x 6 / 2 x 2.5	1 x 4 / 2 x 2.5	2 x (0.5...1.5)	2 x (0.5...1.5)
	AWG	1 x 10 / 2 x 14	1 x 12 / 2 x 14	2 x (21...18)	2 x (21...18)

Contact specification

F 48 - Electrical life (AC) v contact current
Types 48.P3/P6/31/61

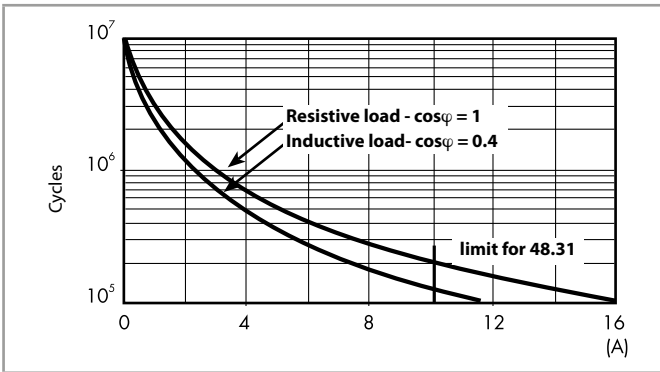

F 48 - Electrical life (AC) v contact current
Types 48.P8/62

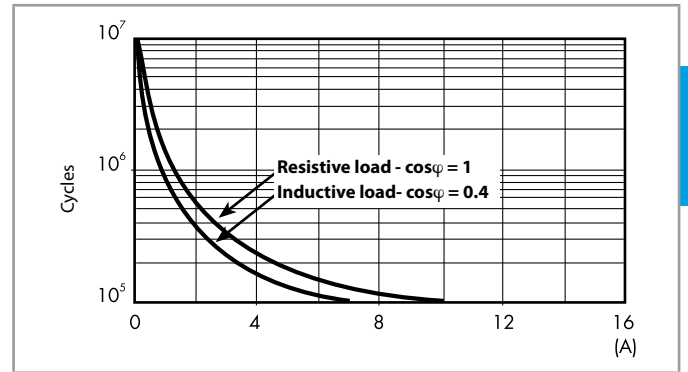

F 48 - Electrical life (AC) v contact current
Types 48.P5/52

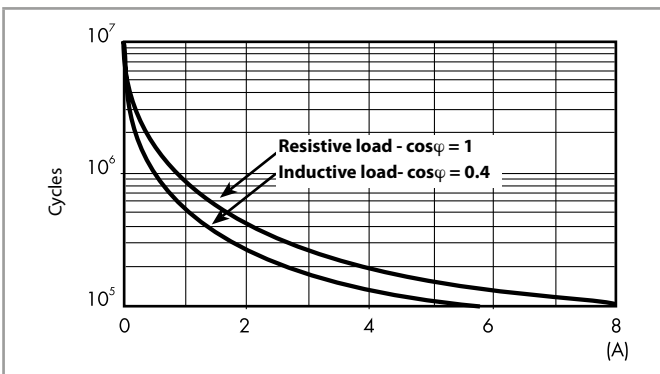

F 48 - Electrical life (AC) v contact current
Type 48.12

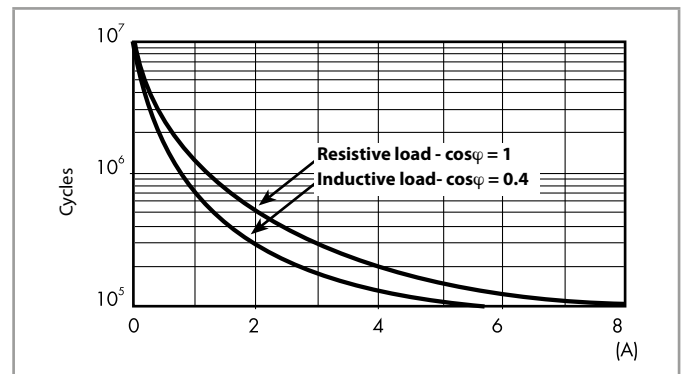

H 48 - Maximum DC1 breaking capacity
Types 48.P3/P5/P6/31/52/61

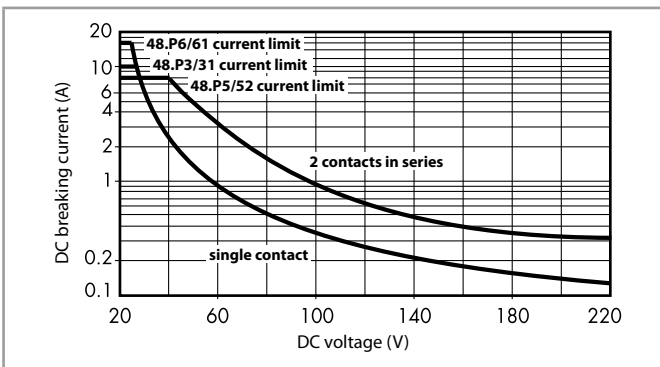

H 48 - Maximum DC1 breaking capacity
Types 48.P8/62

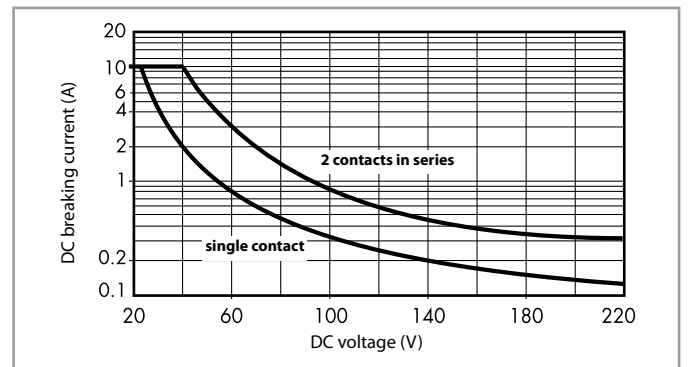

H 48 - Maximum DC1 breaking capacity
Type 48.12

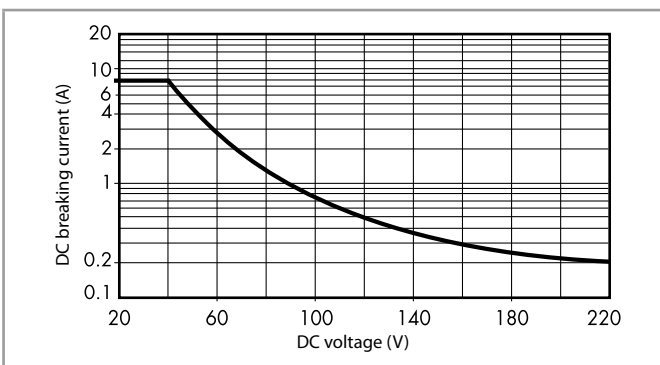

- When switching a resistive load (DC1) having voltage and current values under the curve, an electrical life of $\geq 100 \cdot 10^3$ can be expected.
- In the case of DC13 loads, the connection of a diode in parallel with the load will permit a similar electrical life as for a DC1 load.
Note: the release time for the load will be increased.

Coil specifications

DC coil data (0.5 W sensitive)

Nominal voltage U_N	Coil code	Operating range		Rated coil consumption I at U_N
		U_{min}^*	U_{max}	
V		V	V	mA
12	7.012	8.8	18	41
24	7.024	17.5	36	22.2
125	7.125	91	188	4

* $U_{min} = 0.8 U_N$ for 48.61, 48.62, 48.P6, 48.P8

AC coil data

Nominal voltage U_N	Coil code	Operating range		Rated coil consumption I at U_N (50 Hz)
		U_{min}	U_{max}	
V		V	V	mA
12	8.012	9.6	13.2	90.5
24	8.024	19.2	26.4	46
110	8.110	88	121	10.1
120	8.120	96	132	11.8
230	8.230	184	253	7.0

DC coil data, 2 pole relay - Type 48.12

Nominal voltage U_N	Coil code	Operating range		Resistance R	Rated coil consumption I at U_N
		U_{min}	U_{max}		
V		V	V	Ω	mA
12	9.012	9	14.4	205	58.5
24	9.024	18	28.8	820	29.3

R 48 - DC coil operating range v ambient temperature

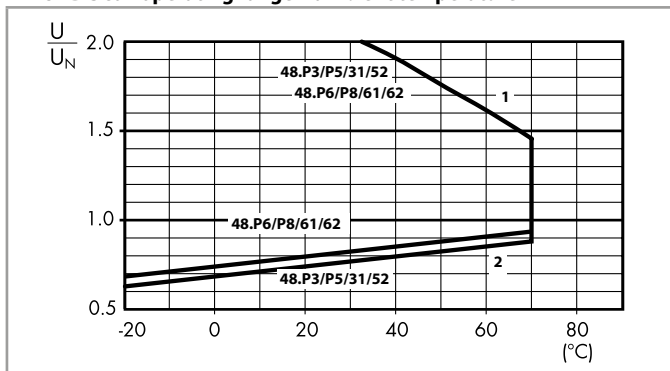

- 1 - Max. permitted coil voltage.
- 2 - Min. pick-up voltage with coil at ambient temperature.

R 48 - AC coil operating range v ambient temperature

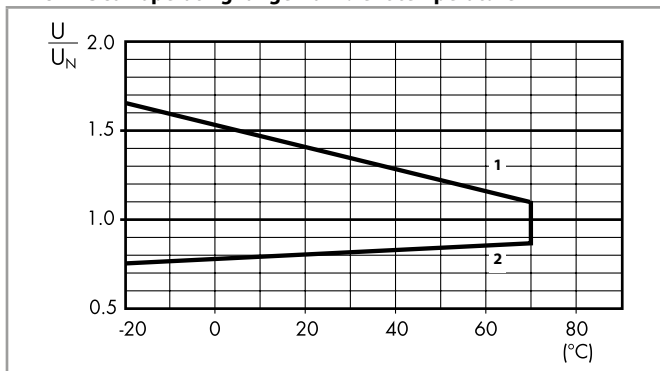

- 1 - Max. permitted coil voltage.
- 2 - Min. pick-up voltage with coil at ambient temperature.

R 48 - DC coil operating range v ambient temperature

Type 48.12

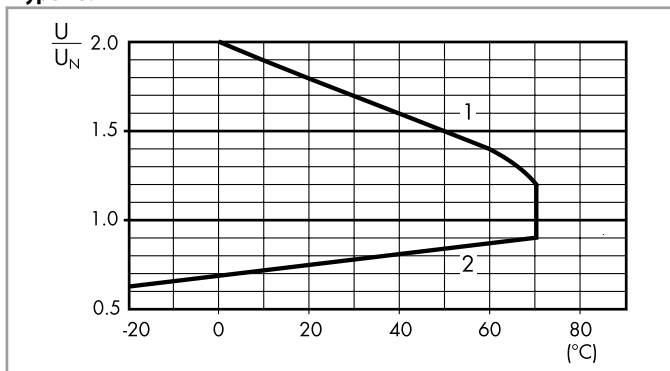

- 1 - Max. permitted coil voltage.
- 2 - Min. pick-up voltage with coil at ambient temperature.

Combinations

Code	Type of socket	Type of relay	Module	Retaining clip
48.12	95.05.0	50.12	—	095.71
48.31	95.03	40.31	99.02	095.01
48.52	95.05	40.52	99.02	095.01
48.61	95.05	40.61	99.02	095.01
48.62	95.05	44.62	99.02	095.01
48.P3	95.P3	40.31	99.02	095.91.3
48.P5	95.P5	40.52	99.02	095.91.3
48.P6	95.P5	40.61	99.02	095.91.3
48.P8	95.P5	44.62	99.02	095.91.3

B

Outline drawing

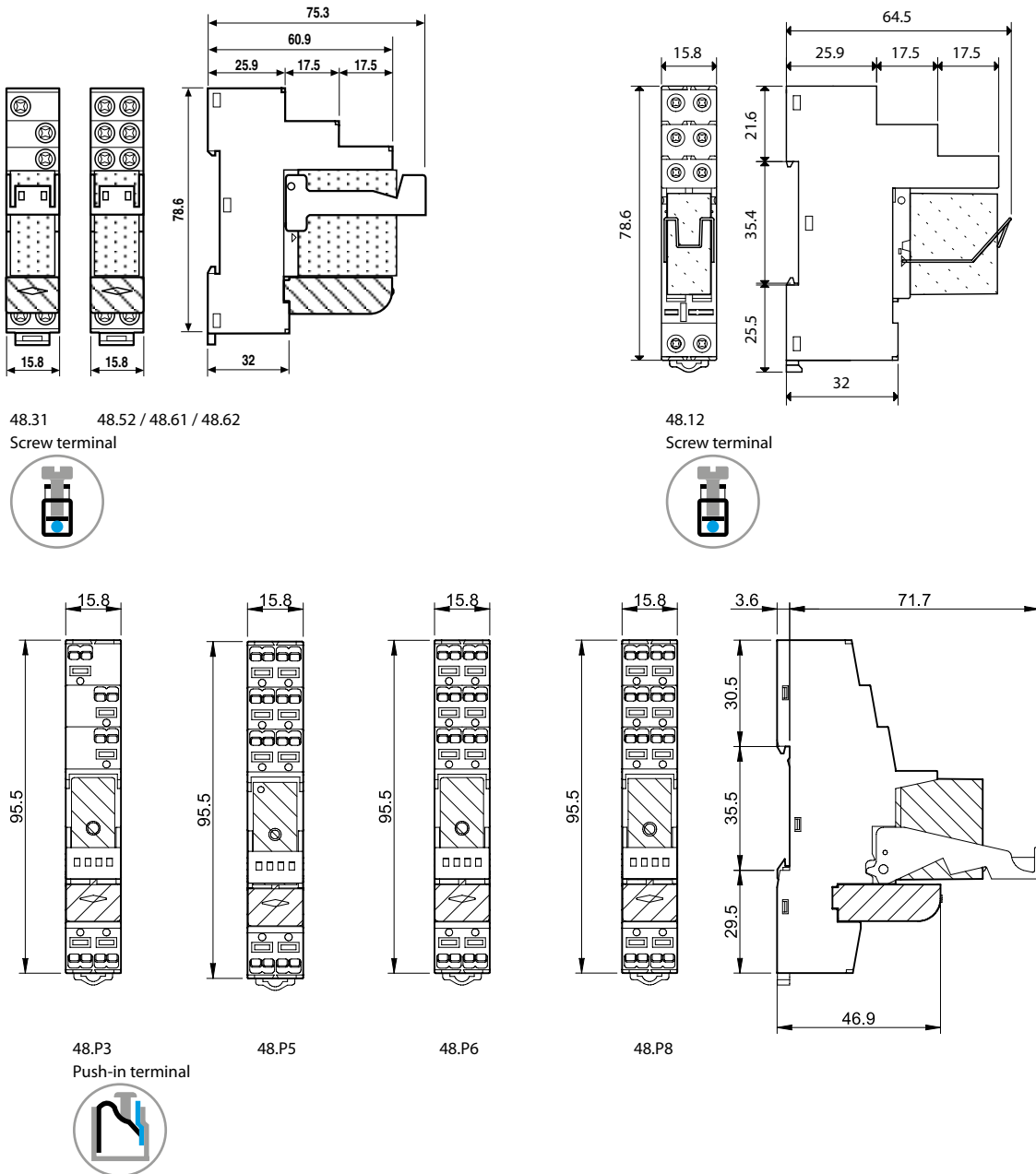

Accessories



097.58

8-way jumper link for type 48.P3/P5/P6/P8	097.58
Rated values	10 A - 250 V

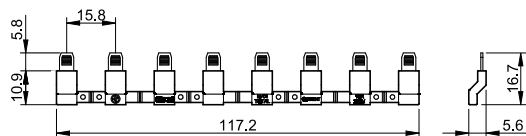

097.52

2-way jumper link for type 48.P3/P5/P6/P8	097.52
Rated values	10 A - 250 V

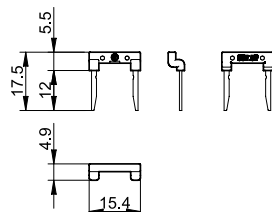

097.42

2-way jumper link for type 48.P3/P5/P6/P8	097.42
Rated values	10 A - 250 V

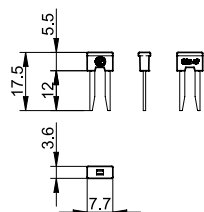

097.00

Marker tag holder for type 48.P3/P5/P6/P8 and 48.12/31/52/61/62	097.00
--	--------

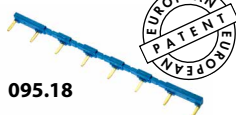
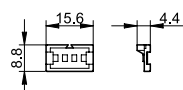

095.18

8-way jumper link for screw terminal version	095.18 (blue)	095.18.0 (black)
Rated values	10 A - 250 V	

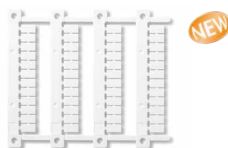
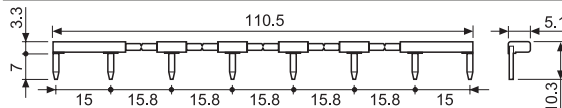

060.48

Sheet of marker tags (CEMBRE'S Thermal transfer printers), plastic, 48 tags, 6 x 12 mm	060.48
---	--------



060.72

Sheet of marker tags (plotter printing), plastic, 72 tags, 6 x 12 mm	060.72
---	--------

Packaging codes

How to code and identify retaining clip and packaging options for sockets.

Example:

4 8 . P 5 . 7 . 0 2 4 . 0 0 5 0 S P A

A Standard packaging
B Blister packaging

SP Plastic retaining clip