

# Interface Relays R600, R500

## Product group picture

5

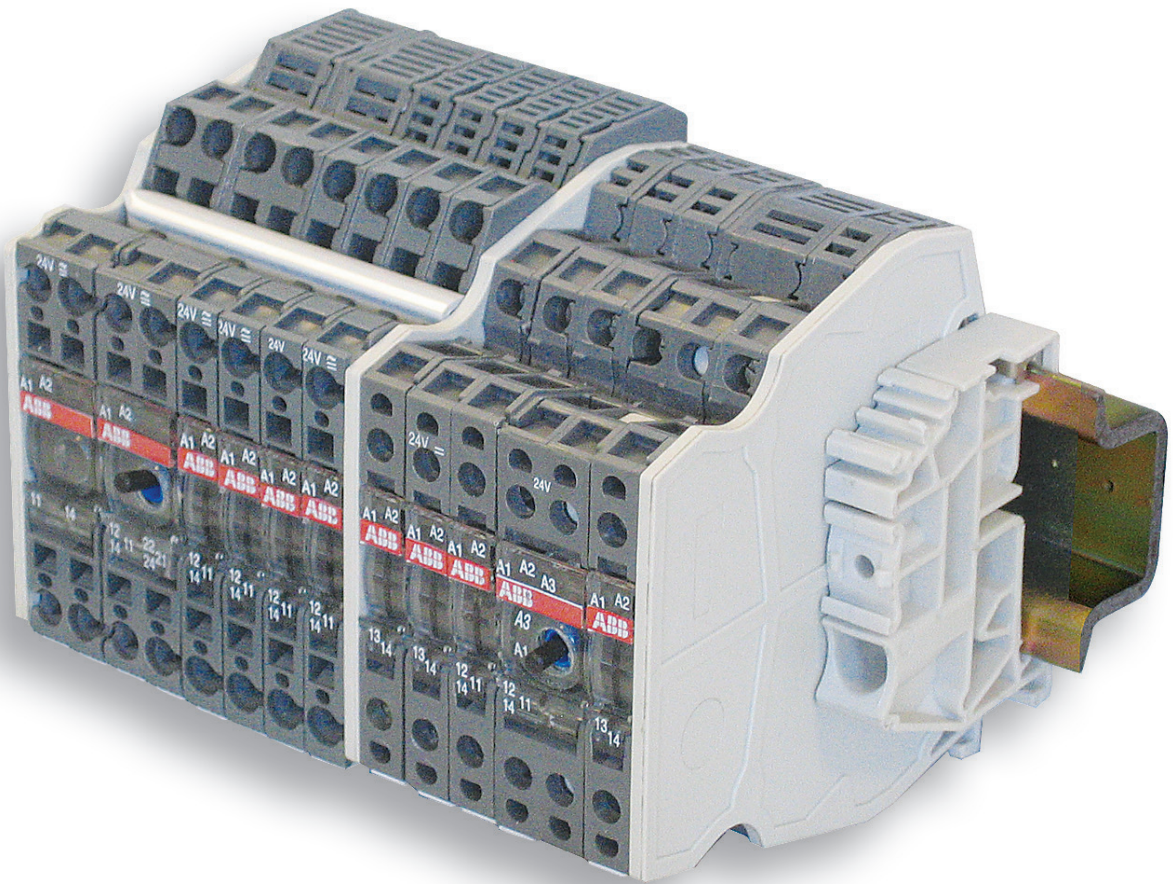

# Interface Relays R600, R500

## Table of contents

<b>Interface Relays R600, R500</b>	
Product group picture	5/21
Table of contents	5/22
Benefits and advantages	5/23
Type designators	5/24
<b>Interface Relays R600</b>	<b>5/25</b>
Selection	5/25
Benefits and advantages	5/27
Ordering details	5/28
Connection diagrams	5/30
Technical information	5/31
<b>Interface Relays R500</b>	<b>5/36</b>
Selection	5/36
Ordering details	5/37
Technical information	5/38

# Interface Relays R600, R500

## Benefits and advantages



R600 series



R500 series

### 5 Standard range in screw clamp or spring clamp versions

- Spacing : 6 mm
- Wire size : 2.5 mm<sup>2</sup> (4 mm<sup>2</sup> solid wire)
- Contact type : 1 NO, 1 NC, 1 SPDT, 1 DPDT from 1 mA to 8 A / 250 V
- Transistor : 100 mA  
MOS : 1 A to 5 A  
Triac : 1 A to 2 A

### It is our range offering pluggable functions

- Spacing : 5.08 mm (the smallest in the market)
- Wire size : 2.5 mm<sup>2</sup> (4 mm<sup>2</sup> solid)
- Contact type : 1 SPDT from 10 mA to 6 A / 250 V
- Transistor : 30 mA to 100 mA  
MOS : 1 A to 2 A  
Triac : 1 A



In today's automation systems, PLCs are the core of industry. They link sensors and actuators to the process, which are connected to the PLC via conventional wires.

However these PLCs are not completely isolated from the industrial environment, hence over voltage picks and transient currents can affect their operating functions. And additionally, their application field is often limited to 24 VDC / 100 mA.

So, with the aim to adapt application voltage and/or current and provide as well the right galvanic isolation to the PLC, it is recommended to install per I/O the right interface providing both voltage-current level adaptation and isolation protection.

This interfacing is possible thanks to ABB's relays and optocouplers ranges, which offer wide adaptation in both voltage (from 5 to 400 V) and current (from 10-7 to 16 A) as well as high isolation between input and output from 2 to 4 KV.

# Interface Relays R600, R500 Type designators

SERIES	CODE	NB OF RELAYS	CONTACT TYPE	NB OF CONTACTS PER RELAY	PARTICULARITIES			
R 600 	<table border="1"><tr><td>R</td><td>B</td></tr></table>	R	B	<input type="checkbox"/>	<input type="checkbox"/>	<input type="checkbox"/>	<input type="checkbox"/>	
R	B							
R 600 	<table border="1"><tr><td>R</td><td>B</td><td>R</td></tr></table>	R	B	R	<input type="checkbox"/>	<input type="checkbox"/>	<input type="checkbox"/>	<input type="checkbox"/>
R	B	R						
R 500	<table border="1"><tr><td>D</td><td>2,5/5</td><td>R</td></tr></table>	D	2,5/5	R	<input type="checkbox"/>	<input type="checkbox"/>	<input type="checkbox"/>	<input type="checkbox"/>
D	2,5/5	R						
		<input type="checkbox"/>	<input type="checkbox"/>	<input type="checkbox"/>	<input type="checkbox"/>			
		↓	↓	↓	↓			
		1	0	1	None			
		2	1	2	A			
			2		B			
			3		C			
					N			
					P			
					R			
					V			
					I			

## Description of contact types

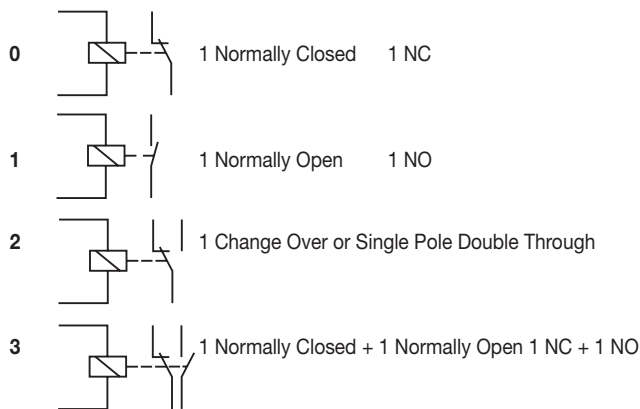

## Features

- None** Input voltage DC
- A** Input voltage AC/DC
- B** Input voltage AC
- C** 2 wire sensor compatibility

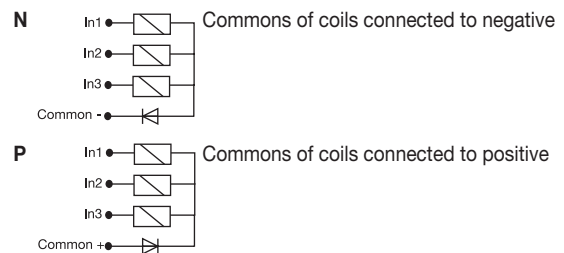
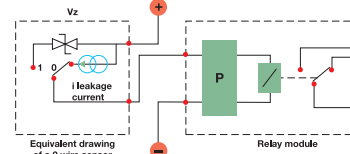

**R** RC circuit protection :  
- Input protection against leakage current

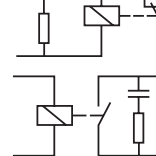

- Increases relay contacts life

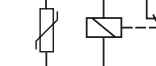

**V** Relay protection against overvoltage peaks

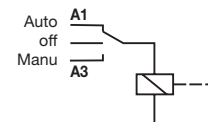

**I** Switch to force the coil for maintenance and/or installation purposes



## Color coding for relays

Color	Current level in contacts	Switching current	Switching voltage	Switching load power
 green	Very low level	10 <sup>-7</sup> to 5 A	10 <sup>-3</sup> to 250 V	10 <sup>-10</sup> to 2000 VA 10 <sup>-10</sup> to 200 W
 grey	Low level	1 mA to 8 A	5 to 250 V	0,05 to 1500 VA 0,05 to 192 W
 blue	High level	10 mA to 16 A	12 to 380 V	0,6 to 4000 VA 0,6 to 240 W

# Interface Relays R600 Selection

Type	Order number
RB 121-5VDC	1SNA 645 034 R2300
RB 121-5VDC	1SNA 645 036 R2500
RBR 121-5VDC	1SNA 645 534 R2500
RBR 121-5VDC	1SNA 645 536 R2700
RB 121-12VDC	1SNA 645 069 R0000
RB 121-12VDC	1SNA 645 037 R2600
RBR 121-12VDC	1SNA 645 569 R0000
RBR 121-12VDC	1SNA 645 537 R2000
RB 101AR-24VAC/DC	1SNA 645 019 R0400
RBR 101AR-24VAC/DC	1SNA 645 519 R0600
RB 111A-24VAC/DC	1SNA 645 014 R2700
RB 111AI-24VAC/DC	1SNA 645 063 R0000
RB 111AR-24VAC/DC	1SNA 645 018 R0300
RBR 111A-24VAC/DC	1SNA 645 514 R2100
RBR 111AI-24VAC/DC	1SNA 645 563 R0200
RBR 111AR-24VAC/DC	1SNA 645 518 R0500
RB 121-24VDC	1SNA 645 064 R0100
RB 121-24VDC	1SNA 645 065 R0200
RB 121A-24VAC/DC	1SNA 645 001 R0300
RB 121A-24VAC/DC	1SNA 645 005 R0700
RB 121AI-24VAC/DC	1SNA 645 032 R2100
RB 121AI-24VAC/DC	1SNA 645 009 R1300
RB 121AI-24VAC/DC	1SNA 645 033 R2200
RB 121AI-24VAC/DC	1SNA 645 010 R0700
RBR 121-24VDC	1SNA 645 564 R0300
RBR 121-24VDC	1SNA 645 565 R0400
RBR 121A-24VAC/DC	1SNA 645 501 R0500
RBR 121A-24VAC/DC	1SNA 645 505 R0100
RBR 121AI-24VAC/DC	1SNA 645 532 R2300
RBR 121AI-24VAC/DC	1SNA 645 509 R1500
RBR 121AI-24VAC/DC	1SNA 645 533 R2400
RBR 121AI-24VAC/DC	1SNA 645 510 R0100
RB 122A-24VAC/DC	1SNA 645 012 R2500
RBR 122A-24VAC/DC	1SNA 645 512 R2700

Input voltage	RB 121-5VDC	RB 121-5VDC	RBR 121-5VDC	RBR 121-5VDC	RB 121-12VDC	RB 121-12VDC	RBR 121-12VDC	RBR 121-12VDC	RB 101AR-24VAC/DC	RBR 101AR-24VAC/DC	RB 111A-24VAC/DC	RB 111AI-24VAC/DC	RB 111AR-24VAC/DC	RBR 111A-24VAC/DC	RBR 111AI-24VAC/DC	RBR 111AR-24VAC/DC	RB 121-24VDC	RB 121-24VDC	RB 121A-24VAC/DC	RB 121A-24VAC/DC	RB 121AI-24VAC/DC	RB 121AI-24VAC/DC	RBR 121-24VDC	RBR 121-24VDC	RBR 121A-24VAC/DC	RBR 121A-24VAC/DC	RBR 121AI-24VAC/DC	RBR 121AI-24VAC/DC	RB 122A-24VAC/DC	RBR 122A-24VAC/DC		
5 V DC	■	■	■	■																												
12 V DC					■	■	■	■																								
24 V DC									■	■	■	■	■	■	■	■	■	■	■	■	■	■	■	■	■	■	■	■	■	■	■	■
48 - 60 V DC																																
110 - 115 V DC																																
230 V DC																																
60 - 230 V DC																																
24 V AC									■	■	■	■	■	■	■	■	■	■	■	■	■	■	■	■	■	■	■	■	■	■	■	■
48 - 60 V AC																																
115 V AC																																
230 V AC																																
60 - 230 V AC																																

Output rating	RB 121-5VDC	RB 121-5VDC	RBR 121-5VDC	RBR 121-5VDC	RB 121-12VDC	RB 121-12VDC	RBR 121-12VDC	RBR 121-12VDC	RB 101AR-24VAC/DC	RBR 101AR-24VAC/DC	RB 111A-24VAC/DC	RB 111AI-24VAC/DC	RB 111AR-24VAC/DC	RBR 111A-24VAC/DC	RBR 111AI-24VAC/DC	RBR 111AR-24VAC/DC	RB 121-24VDC	RB 121-24VDC	RB 121A-24VAC/DC	RB 121A-24VAC/DC	RB 121AI-24VAC/DC	RB 121AI-24VAC/DC	RBR 121-24VDC	RBR 121-24VDC	RBR 121A-24VAC/DC	RBR 121A-24VAC/DC	RBR 121AI-24VAC/DC	RBR 121AI-24VAC/DC	RB 122A-24VAC/DC	RBR 122A-24VAC/DC				
10 mA - 6 A	■	■	■	■	■	■	■	■	■	■	■	■	■	■	■	■	■	■	■	■	■	■	■	■	■	■	■	■	■	■	■	■		
1 mA - 6 A		■	■	■	■	■	■	■											■	■	■	■	■	■	■	■	■	■	■	■	■	■		
1 mA - 8 A																																	■	■

Output contacts	RB 121-5VDC	RB 121-5VDC	RBR 121-5VDC	RBR 121-5VDC	RB 121-12VDC	RB 121-12VDC	RBR 121-12VDC	RBR 121-12VDC	RB 101AR-24VAC/DC	RBR 101AR-24VAC/DC	RB 111A-24VAC/DC	RB 111AI-24VAC/DC	RB 111AR-24VAC/DC	RBR 111A-24VAC/DC	RBR 111AI-24VAC/DC	RBR 111AR-24VAC/DC	RB 121-24VDC	RB 121-24VDC	RB 121A-24VAC/DC	RB 121A-24VAC/DC	RB 121AI-24VAC/DC	RB 121AI-24VAC/DC	RBR 121-24VDC	RBR 121-24VDC	RBR 121A-24VAC/DC	RBR 121A-24VAC/DC	RBR 121AI-24VAC/DC	RBR 121AI-24VAC/DC	RB 122A-24VAC/DC	RBR 122A-24VAC/DC			
c/o	1	1	1	1	1	1	1	1									1	1	1	1	1	1	1	1	1	1	1	1	1	1	2	2	
n/o											1	1	1	1	1	1																	
n/c									1	1																							

Terminal type	RB 121-5VDC	RB 121-5VDC	RBR 121-5VDC	RBR 121-5VDC	RB 121-12VDC	RB 121-12VDC	RBR 121-12VDC	RBR 121-12VDC	RB 101AR-24VAC/DC	RBR 101AR-24VAC/DC	RB 111A-24VAC/DC	RB 111AI-24VAC/DC	RB 111AR-24VAC/DC	RBR 111A-24VAC/DC	RBR 111AI-24VAC/DC	RBR 111AR-24VAC/DC	RB 121-24VDC	RB 121-24VDC	RB 121A-24VAC/DC	RB 121A-24VAC/DC	RB 121AI-24VAC/DC	RB 121AI-24VAC/DC	RBR 121-24VDC	RBR 121-24VDC	RBR 121A-24VAC/DC	RBR 121A-24VAC/DC	RBR 121AI-24VAC/DC	RBR 121AI-24VAC/DC	RB 122A-24VAC/DC	RBR 122A-24VAC/DC			
Screw	■	■			■	■			■	■	■	■	■	■	■	■	■	■	■	■	■	■	■	■	■	■	■	■	■	■	■	■	■
Spring			■	■			■	■									■	■	■	■	■	■	■	■	■	■	■	■	■	■	■	■	■



# Interface Relays R600

## Benefits and advantages

### Characteristics

Standard range in screw clamp or spring clamp versions

- Spacing : 6 mm
- Wire size : 2.5 mm<sup>2</sup> (4 mm<sup>2</sup> solid wire)
- Contact type : 1 NO, 1 NC, 1 SPDT, 1 DPDT from 1 mA to 8 A / 250 V
- Transistor : 100 mA
  - MOS : 1 A to 5 A
  - Triac : 1 A to 2 A

### Benefits

**5 Increased contact life**  
The contacts are protected by built in RC-circuits which result in increased contact life.

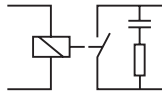

### Variety of connections

R600 relays and optocouplers are available with both screw terminals or spring terminals.

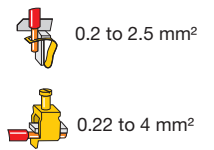

### Space saving

With a width of only 6 mm or 12 mm the compact design saves space in each cabinet.

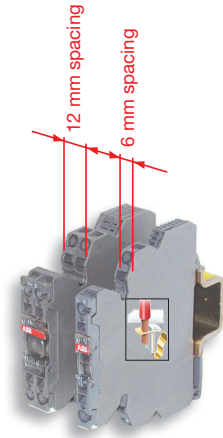

### Functioning status

Functioning display through a green LED.



### Only one part number AC/DC

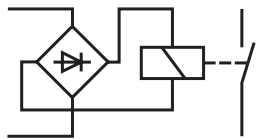

### Measurement & Test

Holes for holding DIA. 2 mm test plugs to simplify any measure or test.



### Excellent adaption and conversion of digital signals

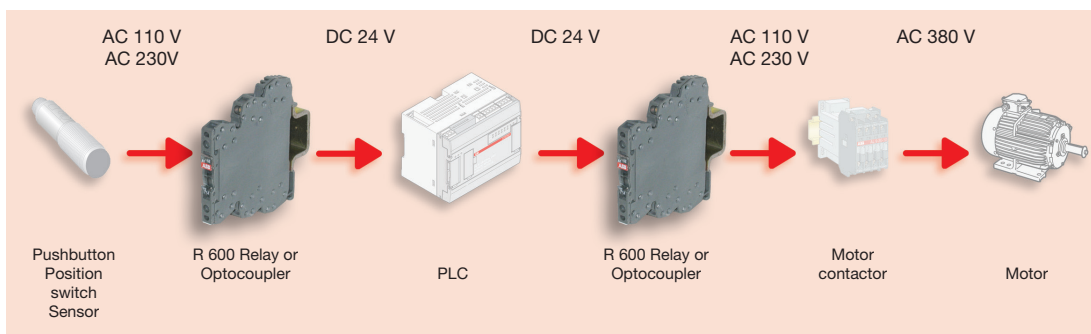



# Interface Relays R600

## Ordering details



R600



R600 Relay	Type	Order code	Price	Pkg qty	Weight (1 pce) kg (lb)
Relay module 1 NO high level 6 mm spacing	RB 111 A-24VAC/DC	1SNA645014R2700		10	0.02 (0.44)
	RB 111 A-48-60VAC/DC	1SNA645015R2000			
	RB 111 A-115VAC/DC	1SNA645016R2100			
	RB 111 A-230VAC/DC	1SNA645017R2200			
Relay mod. 1 NO high level w/ safety switch 6 mm spacing	RB 111 AI-24VAC/DC	1SNA645063R0000		5	0.03 (0.44)
	Relay mod. 1 NO high level w/ contact protection 12 mm spacing	RB 111 AR-24VAC/DC	1SNA645018R0300		
Relay mod. 1 NC high level w/ contact protection 12 mm spacing	RB 101 AR-24VAC/DC	1SNA645019R0400		10	0.02 (0.44)
	RBR 111 A-24VAC/DC	1SNA645514R2100			
	RBR 111 A-48-60VAC/DC	1SNA645515R2200			
Relay module 1 NO high level 6 mm spacing	RBR 111 A-115VAC/DC	1SNA645516R2300		10	0.02 (0.44)
	RBR 111 A-230VAC/DC	1SNA645517R2400			
	Relay mod. 1 NO high level w/ safety switch 6 mm spacing	RBR 111 AI-24VAC/DC	1SNA6455563R0200		
Relay mod. 1 NO high level w/ contact protection 12 mm spacing	RBR 111 AR-24VAC/DC	1SNA645518R0500		5	0.03 (0.44)
	Relay mod. 1 NC high level w/ contact protection 12 mm spacing	RBR 101 AR-24VAC/DC	1SNA645519R0600		
Relay module 1 SPDT high level	RB 121 5VDC	1SNA645034R2300		10	0.02 (0.44)
	RB 121 12VDC	1SNA645069R0100			
	RB 121 24VDC	1SNA645064R0100			
	RB 121 A-24VAC/DC	1SNA645001R0300			
	RB 121 A-48-60VAC/DC	1SNA645002R0400			
	RB 121 A-115VAC/DC	1SNA645003R0500			
Relay module 1 SPDT high level	RB 121 A-230VAC/DC	1SNA645004R0400		10	0.02 (0.44)
	RB 121 5VDC	1SNA645534R2500			
	RB 121 12VDC	1SNA645569R0000			
	RB 121 24VDC	1SNA645564R0300			
	RB 121 A-24VAC/DC	1SNA645501R0500			
	RB 121 A-48-60VAC/DC	1SNA645502R0600			
Relay module 1 SPDT low level	RB 121 A-115VAC/DC	1SNA645503R0700		10	0.02 (0.44)
	RB 121 A-230VAC/DC	1SNA645504R0000			
	RB 121 5VDC	1SNA645036R2500			
	RB 121 12VDC	1SNA645037R2600			
	RB 121 24VDC	1SNA645065R0200			
	RB 121 A-24VAC/DC	1SNA645005R0700			
Relay module 1 SPDT low level	RB 121 A-48-60VAC/DC	1SNA645006R0000		10	0.02 (0.44)
	RB 121 A-115VAC/DC	1SNA645007R0100			
	RB 121 A-230VAC/DC	1SNA645008R1200			
	RB 121 5VDC	1SNA645536R2700			
	RB 121 12VDC	1SNA645537R2000			
	RB 121 24VDC	1SNA645565R0400			

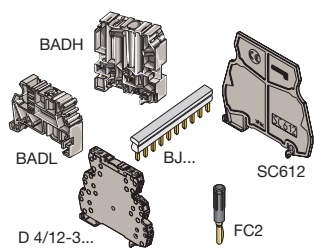

Accessories R600	Type	Order code	Price	Pkg qty	Weight (1 pce) kg (lb)
End section	BADH V0	1SNA116900R2700		50	
	BADL V0	1SNA399903R0200		50	
	BAM2 V0	1SNA399967R0100		50	
Separator end section	SC 612	1SNA290474R0200		10	
Divisible shunt 10 poles	BJ 612-10	1SNA290488R0100		10	
Divisible shunt 70 poles	BJ 612-70	1SNA290489R0200		10	
Screw clamp distribution block sp. 12 mm	D4/12-3-3	1SNA645031R2000		5	
Spring clamp distribution block sp. 12 mm	D4/12-3R-3R	1SNA645531R2200		5	
Test plug DIA. 2 mm	FC2	1SNA645531R2200		10	
Marking method	RC65 / RC610	see marking			



# Interface Relays R600























## Ordering details

5



R600

-  High level
-  Low level

R600 Relay	Type	Order code	Price	Pkg qty	Weight (1 pce) kg (lb)
 Relay mod. 1SPDT high level w/leakage current protec.	RB 121 AR-115VAC/DC	1SNA645046R0700		5	0.03 (0.066)
 Relay mod. 1SPDT high level w/leakage current protec.	RB 121 AR-230VAC/DC	1SNA645011R2400			
 Relay mod. 1SPDT high level w/large coil voltage range	RB 121 A 60-230VAC/DC	1SNA645020R0100			
 Relay mod. 1SPDT high level with switch	RB 121 AI-24VAC/DC	1SNA645032R2100			
 Relay mod. 1SPDT high level with safety switch	RB 121 AI-24VAC/DC	1SNA645009R1300			
 Relay module 1SPDT low level with switch	RB 121 AI-24VAC/DC	1SNA645033R2200			
 Relay module 1SPDT low level with safety switch	RB 121 AI-24VAC/DC	1SNA645010R0700			
 Relay mod. 1SPDT high level w/leakage current protec.	RB 121 AR-115VAC/DC	1SNA645546R0100			
 Relay mod. 1SPDT high level w/leakage current protec.	RB 121 AR-230VAC/DC	1SNA645511R2600			
 Relay mod. 1SPDT high level w/large coil voltage range	RB 121 A 60-230VAC/DC	1SNA645520R0300			
 Relay mod. 1SPDT high level with switch	RB 121 AI-24VAC/DC	1SNA645532R2300			
 Relay mod. 1SPDT high level with safety switch	RB 121 AI-24VAC/DC	1SNA645509R1500			
 Relay module 1SPDT low level with switch	RB 121 AI-24VAC/DC	1SNA645533R2400			
 Relay module 1SPDT low level with safety switch	RB 121 AI-24VAC/DC	1SNA645510R0100			
 Relay module 1 DPDT low level	RB 122 A-24VAC/DC	1SNA645012R2500		5	0.03 (0.066)
 Relay module 1 DPDT low level	RB 122 A-48-60VAC/DC	1SNA645040R1500			
 Relay module 1 DPDT low level	RB 122 A-115VAC/DC	1SNA645041R0200			
 Relay module 1 DPDT low level	RB 122 A-230VAC/DC	1SNA645013R2600			
 Relay module 1 DPDT low level	RBR 122 A-24VAC/DC	1SNA645512R2700			
 Relay module 1 DPDT low level	RBR 122 A-48-60VAC/DC	1SNA645540R1700			
 Relay module 1 DPDT low level	RBR 122 A-115VAC/DC	1SNA645541R0400			
 Relay module 1 DPDT low level	RBR 122 A-230VAC/DC	1SNA645513R2000			

Accessories R600	Type	Order code	Price	Pkg qty	Weight (1 pce) kg (lb)
End section	BADH V0	1SNA116900R2700		50	
	BADL V0	1SNA399903R0200		50	
	BAM2 V0	1SNA399967R0100		50	
Seperator end section	SC 612	1SNA290474R0200		10	
Divisible shunt 10 poles	BJ 612-10	1SNA290488R0100		10	
Divisible shunt 70 poles	BJ 612-70	1SNA290489R0200		10	
Screw clamp distribution block sp. 12 mm	D4/12-3-3	1SNA645031R2000		5	
Spring clamp distribution block sp. 12 mm	D4/12-3R-3R	1SNA645531R2200		5	
Test plug DIA. 2 mm	FC2	1SNA645531R2200		10	
Marking method	RC65 / RC610	see marking			

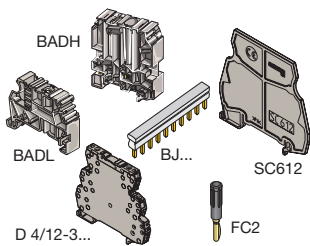

# Interface Relays R600

## Connection diagrams

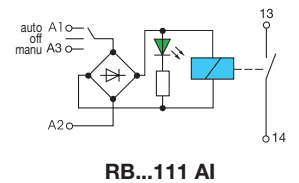
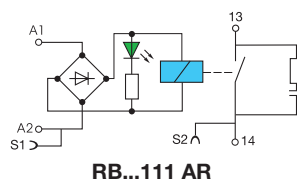
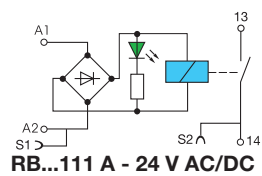
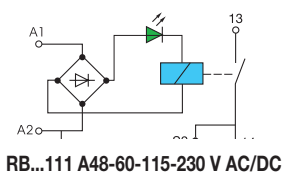
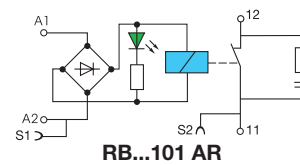
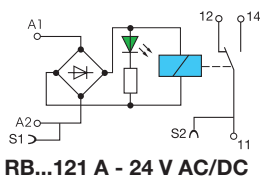
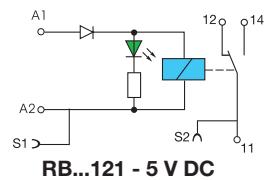
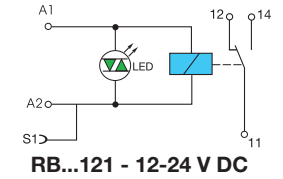
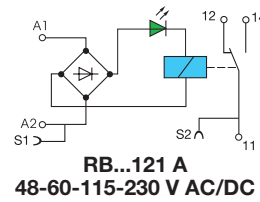
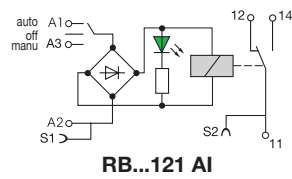
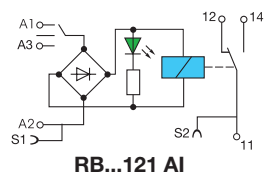
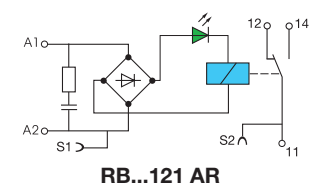
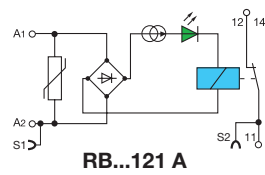
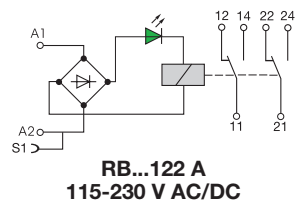
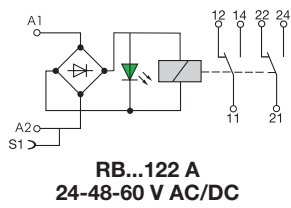
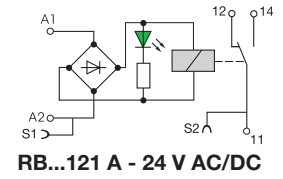
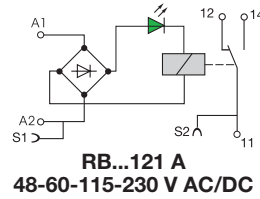
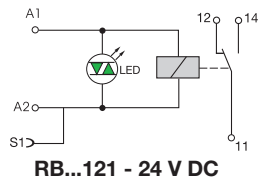
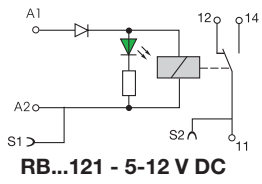

# Interface Relays R600

## Technical information

### Technical data

Relay : 1NO or 1NC high level contact 10 mA to 6 A - 6 mm .236" or 12 mm .472" spacing

	RB 111 A					RB 111 AI	RB 111 AR	RB 101 AR
<b>Relay characteristics coil</b>								
Rated voltage: +20%, -15% on DC ; 10%, -10% on AC	24 VAC/DC	48 VAC/DC	60 VAC/DC	115 VAC/DC	230 VAC/DC ± 10% on AC ± 10%-15% on DC	24 VAC/DC	24 VAC/DC	24 VAC/DC
Frequency	50/60 Hz							
Power	0.24 W	0.34 W	0.54 W	0.46 W	0.8 W	0.24 W	0.24 W	0.24 W
Rated current	10 mA	7 mA	9 mA	4 mA	3.5 mA	10 mA	10 mA	10 mA
Drop-out voltage at 20°C	4.5 V	8 V	8 V	17 V	27 V	4.5 V	4.5 V	4.5 V
Status device	green LED							
<b>Relay characteristics contact</b>								
Type	1 NO					1 NO + RC		
Voltage switching range min./max.	12 V / 250 VAC							
Current switching range min./max.	10 mA / 6 A							
Load switching range	AC1 min./max. 0.6 VA / 1500 VA (ohmic load) DC1 min./max. 0.6 W / 140 W							
Number of on-load operations	10 <sup>5</sup> on AC15							
Number of off-load operations	10 <sup>7</sup>							
Operation speed	F	5 ms	6 ms	7 ms		5 ms		
	O	8 ms		15 ms		8 ms		
Bounce	1.2 ms							
Insulation coil / contact	4000 V RMS					3800 V RMS		4000 V RMS
Resistance to shock coil / contact	4000 V RMS							
Insulation contact / contact	1000 V RMS							
Ambient temperature	storage	-40 °C to +80 °C						
	operating	-20 °C to +70 °C <sup>1)</sup>						
<b>Other characteristics</b>								
	<b>Screw clamp</b>				<b>Spring clamp</b>			
Body material	grey	UL 94 V0						
Wire size	Solid wire	0.2 - 4 mm <sup>2</sup> (24-12 AWG)				0.2-2.5 mm <sup>2</sup> (24-12 AWG)		
	Stranded wire	0.22 - 2.5 mm <sup>2</sup> (24-12 AWG)						
Rated wire size	2.5 mm <sup>2</sup> (12 AWG)							
Wire stripping length	9 mm (0.354 in)							
Recommended screwdriver	3.5 mm (0.137 in)							
Protection	IP20 NEMA1							
Recommended torque	0.4-0.6 Nm (3.5-5.3 lb.in)							
Approvals								
Reference standards	CEI 947-7-1 / CEI 947-1 / CEI 1131-2 (in relevant parts) / CEI 60664-1 / CEM : IRC 1000-4-2, 3, 4, 5, 6.							

<sup>1)</sup> Over 55°C, blocks have to be mounted on horizontal rail with 10 mm spacing between each block. For vertical rail mounting use temperature is 15°C less decreased.

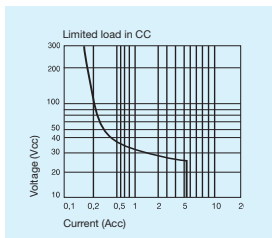

	DC12	AC12	DC13	AC15
24 V	6 A	6 A	1 A	3 A
110/120 V	0,3 A	6 A	0,2 A	3 A
220/230 V	0,2 A	6 A	0,1 A	3 A

### Dimensional drawings

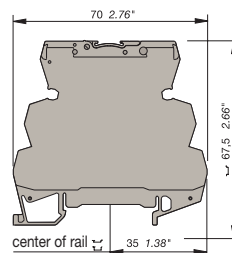

Screw clamp module

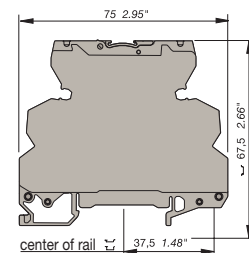

Spring clamp module

# Interface Relays R600

## Technical information

### Technical data

Relay : 1 SPDT high level contact 10 mA to 6 A - 6 mm .236"

	RB 121				RB 121A			
<b>Relay characteristics coil</b>								
Rated voltage: +20%, -15% on DC ; 10%, -10% on AC	5 V DC	12 V DC	24 V DC	24 V AC/DC	48 V AC/DC	60 V AC/DC	115 V AC/DC	230 V AC/DC ± 10% on AC ± 10%-15% on DC
Frequency	-			50/60 Hz				
Power	0.2 W	0.2 W	0.28 W	0.24 W	0.33 W	0.54 W	0.46 W	0.8 W
Rated current	40 mA	16 mA	12 mA	10 mA	7 mA	9 mA	4 mA	3.5 mA
Drop-out voltage at 20°C	1.2 V	2.2 V	1.2 V	4.5 V	8 V	8 V	17 V	27 V
Status device	green LED							
<b>Relay characteristics contact</b>								
Type	1 SPDT							
Voltage switching range min./max.	12 V / 250 V AC							
Current switching range min./max.	10 mA / 6 A							
Load switching range	0.6 VA / 1500 VA (ohmic load)							
AC1 min./max.	0.6 W / 140 W							
DC1 min./max.	10 <sup>5</sup> on AC15							
Number of on-load operations	10 <sup>7</sup>							
Number of off-load operations	10 <sup>7</sup>							
Operation speed	F	5 ms				6 ms		7 ms
	O	8 ms				15 ms		16 ms
Bounce	1.2 ms							
Insulation coil / contact	4000 V RMS							
Resistance to shock coil / contact	4000 V RMS							
Insulation contact / contact	1000 V RMS							
Ambient temperature	storage	-40 °C to -80 °C						
	operating	-20 °C to 70 °C <sup>1)</sup>						
<b>Other characteristics</b>								
		<b>Screw clamp</b>			<b>Spring clamp</b>			
Body material	grey	UL 94 V0						
Wire size	Solid wire	0.2 - 4 mm <sup>2</sup> (24-12 AWG)			0.2-2.5 mm <sup>2</sup> (24-12 AWG)			
	Stranded wire	0.22 - 2.5 mm <sup>2</sup> (24-12 AWG)						
Rated wire size		2.5 mm <sup>2</sup> (12 AWG)						
Wire stripping length		9 mm (0.354 in)						
Recommended screwdriver		3.5 mm (0.137 in)						
Protection		IP20 NEMA1						
Recommended torque		0.4-0.6 Nm (3.5-5.3 lb.in)						
Approvals		UL (pending for 12 V DC), (pending), LRS, CE						
Reference standards		CEI 947-7-1 / CEI 947-1 / CEI 1131-2 (in relevant parts) / CEI 60664-1 / CEM : IRC 1000-4-2, 3, 4, 5, 6.						

<sup>1)</sup> Over 55°C, blocks have to be mounted on horizontal rail with 10 mm spacing between each block. For vertical rail mounting use temperature is 15°C less decreased.

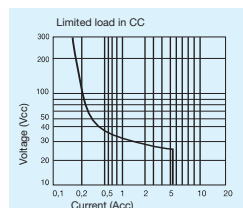

	DC12	AC12	DC13	AC15
24 V	6 A	6 A	1 A	3 A
110/120 V	0,3 A	6 A	0,2 A	3 A
220/230 V	0,2 A	6 A	0,1 A	3 A

### Dimensional drawings

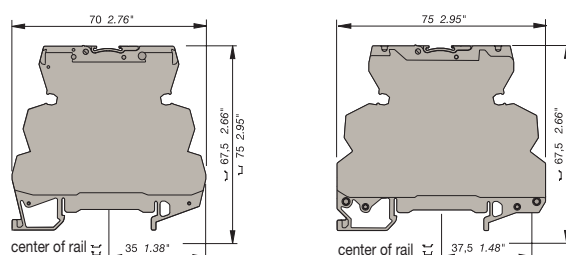

Screw clamp module

Spring clamp module

# Interface Relays R600

## Technical information

### Technical data

Relay : 1 SPDT low level with contact 1 mA upto 6 A - 6 m 0.236" spacing

	RB 121				RB 121 A			
<b>Relay characteristics coil</b>								
Rated voltage: +20%, -15% on DC ; 10%, -10% on AC	5 V DC	12 V DC	24 V DC	24 VAC/DC	48 VAC/DC	60 V AC/DC	115 V AC/DC	230 V AC/DC ± 10% on AC ± 10%-15% on DC
Frequency	50/60 Hz							
Power	0.2 W	0.2 W	0.28 W	0.24 W	0.33 W	0.54 W	0.46 W	0.8 W
Rated current	40 mA	16 mA	12 mA	10 mA	7 mA	9 mA	4 mA	3.5 mA
Drop-out voltage at 20°C	1.2 V	2.2 V	1.2 V	4.5 V	8 V	8 V	17 V	27 V
Status device	green LED							

5

### Relay characteristics contact

Type	1 SPDT								
Voltage switching range min./max.	5 V / 250 V AC								
Current switching range min./max.	1 mA / 6 A								
Load switching range	AC1 min./max.		0.05 VA / 1500 VA (ohmic load)						
	DC1 min./max.		0.05 W / 140 W						
Number of on-load operations	10 <sup>5</sup> on AC15								
Number of off-load operations	10 <sup>7</sup>								
Operation speed	F	5 ms	5 ms	5 ms	5 ms	5 ms	5 ms	6 ms	7 ms
	O	8 ms	8 ms	8 ms	8 ms	8 ms	8 ms	15 ms	16 ms
Insulation coil / contact	4000 V RMS								
Resistance to shock coil / contact	4000 V RMS								
Insulation contact / contact	1000 V RMS								
Ambient temperature	storage		-40 °C to -80 °C						
	operating		-20 °C to 70 °C <sup>1)</sup>						

### Other characteristics

		Screw clamp	Spring clamp
Body material	grey	UL 94 V0	
Wire size	Solid wire	0.2 - 4 mm <sup>2</sup> (24-12 AWG)	0.2-2.5 mm <sup>2</sup> (24-12 AWG)
	Stranded wire	0.22 - 2.5 mm <sup>2</sup> (24-12 AWG)	
Rated wire size		2.5 mm <sup>2</sup> (12 AWG)	
Wire stripping length		9 mm (0.354 in)	
Recommended screwdriver		3.5 mm (0.137 in)	
Protection		IP20 NEMA1	
Recommended torque		0.4-0.6 Nm (3.5-5.3 lb.in)	
Approvals		UL (pending for 24 V DC), CE (pending), LRS, CE	
Reference standards		CEI 947-7-1 / CEI 947-1 / CEI 1131-2 (in relevant parts) / CEI 60664-1 / CEM : IRC 1000-4-2, 3, 4, 5, 6.	

<sup>1)</sup> Over 55°C, blocks have to be mounted on horizontal rail with 10 mm spacing between each block. For vertical rail mounting use temperature is 15°C less decreased.

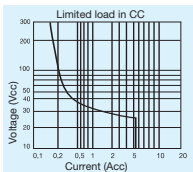

	DC12	AC12	DC13	AC15
24 V	6 A	6 A	1 A	3 A
110/120 V	0,3 A	6 A	0,2 A	3 A
220/230 V	0,2 A	6 A	0,1 A	3 A

### Dimensional drawings

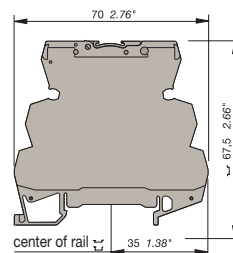

Screw clamp module

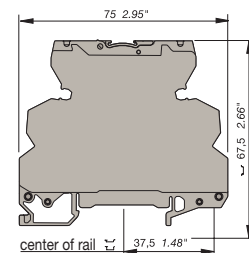





Spring clamp module

# Interface Relays R600

## Technical information

### Technical data

-  Relay : 1 SPDT high level with switch or large coil voltage range or with leakage current protection 12 mm 0.472" spacing
-  Relay : 1 SPDT low level with switch - 12 mm 0.472" spacing

	RB 121 AR		RB 121AI	RB 121 AI		RB 121 AI			
<b>Relay characteristics coil</b>									
Rated voltage: +20%, -15% on DC ; 10%, -10% on AC	115 V AC/DC	230 V AC/DC ± 10% on AC ± 10%-15% on DC	24 VAC/DC		24 VAC/DC		60 to 253 VAC/DC		
Frequency	50/60 Hz								
Power	2 W	2.8 W	0.24 W		0.24 W		1 W		
Rated current	18 mA	12 mA	10 mA		10 mA		4 mA max.		
Drop-out voltage at 20°C	17 V	27 V	4.5 V		4.5 V		15 V		
Permissible leakage current	1.6 mA	1 mA							
Status device	green LED								
<b>Relay characteristics contact</b>									
Type	1 SPDT								
Voltage switching range min./max.	12 V / 250 V AC				5 V / 250 V		12 V / 250 V		
Current switching range min./max.	10 mA / 6 A								
Load switching range	AC1 min./max.	0.6 VA / 1500 VA (ohmic load)				0.05 VA / 1500 VA (ohmic load)		0.6 VA / 1500 VA (ohmic load)	
	DC1 min./max.	0.6 W / 140 W				0.05 W / 140 W		0.6 W / 140 W	
Number of on-load operations	10 <sup>5</sup> on AC15								
Number of off-load operations	10 <sup>7</sup>								
Operation speed	F	6 ms	7 ms	5 ms		5 ms	5 ms	7 ms	
	O	15 ms	16 ms	8 ms		8 ms	8 ms	20 ms	
Insulation coil / contact	4000 V RMS								
Resistance to shock coil / contact	4000 V RMS								
Insulation contact / contact	1000 V RMS								
Ambient temperature	storage	-40 °C to -80 °C							
	operating	-20 °C to 70 °C <sup>1)</sup>							
<b>Other characteristics</b>		<b>Screw clamp</b>				<b>Spring clamp</b>			
Body material	grey	UL 94 V0							
Wire size	Solid wire	0.2 - 4 mm <sup>2</sup> (24-12 AWG)				0.2-2.5 mm <sup>2</sup> (24-12 AWG)			
	Stranded wire	0.22 - 2.5 mm <sup>2</sup> (24-12 AWG)							
Rated wire size	2.5 mm <sup>2</sup> (12 AWG)								
Wire stripping length	9 mm (0.354 in)								
Recommended screwdriver	3.5 mm (0.137 in)								
Protection	IP20 NEMA1								
Recommended torque	0.4-0.6 Nm (3.5-5.3 lb.in)								
Approvals	  (pending),  , 								
Reference standards	CEI 947-7-1 / CEI 947-1 / CEI 1131-2 (in relevant parts) / CEI 60664-1 / CEM : IRC 1000-4-2, 3, 4, 5, 6.								

<sup>1)</sup> Over 55°C, blocks have to be mounted on horizontal rail with 10 mm spacing between each block. For vertical rail mounting use temperature is 15°C less decreased.

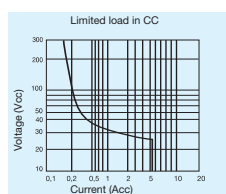

	DC12	AC12	DC13	AC15
24 V	6 A	6 A	1 A	3 A
110/120 V	0,3 A	6 A	0,2 A	3 A
220/230 V	0,2 A	6 A	0,1 A	3 A

### Dimensional drawings

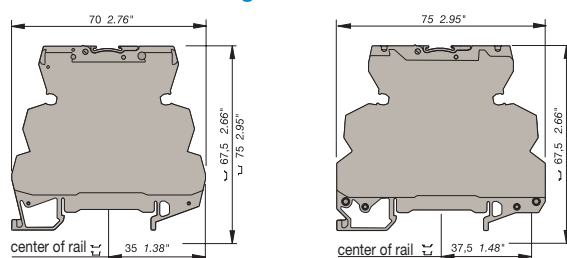

Screw clamp module





Spring clamp module

# Interface Relays R600

## Technical information

### Technical data

Relay : 1 DPDT low level contact 1 mA to 8 A - 12 mm 0.472" spacing

		RB ... 122A				
<b>Relay characteristics coil</b>						
Rated voltage: +20%, -15% on DC ; 10%, -10% on AC		24 V AC/DC	48 V AC/DC	60 V AC/DC	115 V AC/DC	230 V AC/DC ± 10% on AC ± 10%-15% on DC
Frequency		50/60 Hz				
Power		0.48 W	0.62 W	0.96 W	0.58 W	1.15 W
Rated current		20 mA	13 mA	16 mA	5 mA	5 mA
Drop-out voltage at 20°C		5.4 V	8.8 V	8.8 V	20 V	10 V
Status device		green LED				
<b>Relay characteristics contact</b>						
Type		1 DPDT				
Voltage switching range min./max.		5 V / 250 V DC - 250 V AC				
Current switching range min./max.		1 mA / 8 A		1 mA / 5 A		
Load switching range	AC1 min./max.	5 mVA / 1500 VA (ohmic load)				
	DC1 min./max.	5 mW / 192 W				
Number of on-load operations		10 <sup>5</sup>				
Number of off-load operations		2 x 10 <sup>7</sup>				
Operation speed	F	6 ms	10 ms	10 ms	6 ms	6 ms
	O	10 ms	14 ms	14 ms	15 ms	15 ms
Bounce		1 ms				
Insulation coil / contact		3500 V RMS				
Resistance to shock coil / contact		3500 V RMS				
Insulation contact / contact		3500 V RMS (between 2 contacts)				
Ambient temperature	storage	-40 °C to -80 °C				
	operating	-20 °C to 70 °C <sup>1)</sup>				
<b>Other characteristics</b>		<b>Screw clamp</b>		<b>Spring clamp</b>		
Body material	grey	UL 94 V0				
Wire size	Solid wire	0.2 - 4 mm <sup>2</sup> (24-12 AWG)		0.2-2.5 mm <sup>2</sup> (24-12 AWG)		
	Stranded wire	0.22 - 2.5 mm <sup>2</sup> (24-12 AWG)				
Rated wire size		2.5 mm <sup>2</sup> (12 AWG)				
Wire stripping length		9 mm (0.354 in)				
Recommended screwdriver		3.5 mm (0.137 in)				
Protection		IP20 NEMA1				
Recommended torque		0.4-0.6 Nm (3.5-5.3 lb.in)				
Approvals		 (pending for 12 V DC),  (pending),  , 				
Reference standards		CEI 947-7-1 / CEI 947-1 / CEI 1131-2 (in relevant parts) / CEI 60664-1 / CEM : IRC 1000-4-2, 3, 4, 5, 6.				

<sup>1)</sup> Over 55°C, blocks have to be mounted on horizontal rail with 10 mm spacing between each block. For vertical rail mounting use temperature is 15°C less decreased.

Max. DC load breaking capacity

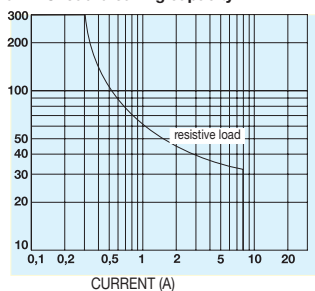

Dimensional drawings

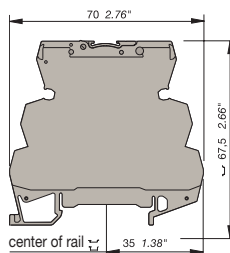

Screw clamp module

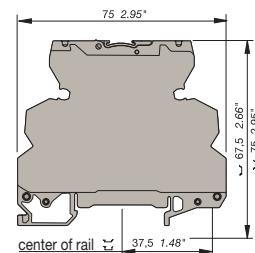

Spring clamp module



# Interface Relays R500 Selection

	Type	Order number
	D 2,5/5-R121-24VDC	1SNA 645 047 R0000
	D 2,5/5-R121L-24VDC	1SNA 645 547 R0200
	D 2,5/5-R121AL-24VAC/DC	1SNA 645 021 R2600
	D 2,5/5-R121AL-48VAC/DC	1SNA 645 521 R2000
	D 2,5/5-R121BL-110VAC	1SNA 645 049 R1200
	D 2,5/5-R121BL-230VAC	1SNA 645 549 R1400
<b>Input voltage</b>		
24 V DC	■ ■ ■	
48 V DC		■
24 V AC		■
48 V AC		■
110 V AC		■
230 V AC		■
<b>Output rating</b>		
10 mA - 6 A	■ ■ ■ ■ ■ ■	
<b>Output contacts</b>		
c/o	1 1 1 1 1 1	
<b>Type</b>		
with LED		■ ■ ■ ■ ■
without LED	■	



R500 series

It is our range offering pluggable functions

- Spacing : 5.08 mm (the smallest in the market)
- Wire size : 2.5 mm<sup>2</sup> (4 mm<sup>2</sup> solid)
- Contact type : 1 SPDT from 10 mA to 6 A / 250 V
- Transistor : 30 mA to 100 mA  
MOS : 1 A to 2 A  
Triac : 1 A

# Interface Relays R500

## Ordering details

5



R500

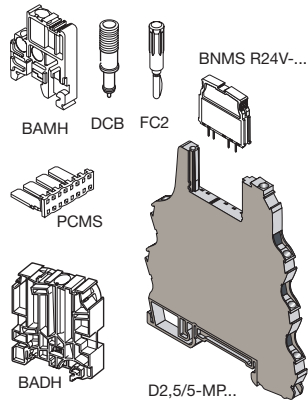

Description of R500 Relay	Type	Order code	Price	Pkg qty	Weight (1 pce) kg (lb)
Relay module 1 SPDT high level	D 2,5/5-R121-24VDC	1SNA607217R0200			0.032 (0.071)
	D 2,5/5-R121L-24VDC	1SNA607201R1300			
Relay module with LED 1 SPDT high level	D 2,5/5-R121AL-24VAC/DC	1SNA607231R0000		10	0.04 (0.088)
	D 2,5/5-R121AL-48VAC/DC	1SNA607232R0100			
	D 2,5/5-R121BL-110VAC	1SNA607264R1100			
	D 2,5/5-R121BL-230VAC	1SNA607265R1200			

R500 Accessories	Type	Order code	Price	Pkg qty	Weight (1 pce) kg (lb)
High end stop	BAMH 9,1 mm	1SNA114836R0000		50	
	BAMH V0 9,1 mm	1SNA194836R0100			
	BADH 12 mm	1SNA116900R2700			
Comb type jumper bar 2 to 22 poles		consult us			
Jumper bar 10 poles grey	PCMS V0	1SNA205523R2200		8	
Relay / Opto base	D 2,5/5-MP	1SNA607224R0100		10	0.028 (0.062)
Relay / Opto base with LED 24 VDC	D 2,5/5-MP-24VDC	1SNA607222R0700			
Relay / Opto base with LED 24 VAC/VDC	D 2,5/5-MP-24VAC/DC	1SNA607260R2100			
Relay / Opto base with LED 48 VAC/VDC	D 2,5/5-MP-48VAC/DC	1SNA607261R1600			
Relay / Opto base with LED 110 VAC	D 2,5/5-MP-110VAC	1SNA607266R1300		4	0.036 (0.0794)
Relay / Opto base with LED 230 VAC	D 2,5/5-MP-230VAC	1SNA607267R1400			
Plug relay 24 V 1 SPDT 10 mA to 6 A	BNMS R24V-1	1SNA031820R1400		4	
Plug relay 24 V 1 SPDT 1 mA to 6 A	BNMS R24V-2	1SNA031847R1300			
Test device blue	DCB <sup>1)</sup>	1SNA105028R2100		10	
Test plug DIA. 2 mm	FC2	1SNA007865R2600			
Marking method	RC55	see marking			

<sup>1)</sup> Only on top decks

### Connection diagrams

High level

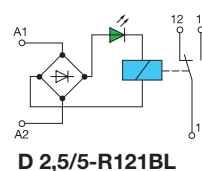
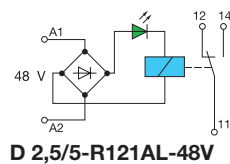
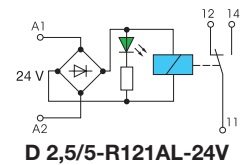
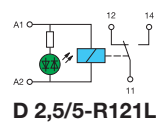
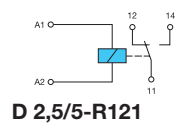



# Interface Relays R500

## Technical information

### Technical data

Relay : 1 SPDT high level with contact 10 mA to 6 A - 5.08mm 0.200" spacing

	D 2.5/5-R121	D 2.5/5-R121L	D 2.5/5-R121AL				D 2.5/5-R121BL		
<b>Relay characteristics coil</b>									
Rated voltage: +20%, -15% on DC ; 10%, -10% on AC	24 V DC	24 V DC	24 V AC	24 V DC	48 V AC	48 V DC	110 V AC	230 V AC	
Frequency			50/60 Hz		50/60 Hz		50/60 Hz	50/60 Hz	
Power	0.17 W	0.3 W	0.35 W	0.35 W	0.44 W	0.47 W	1.08 W	2.13 W	
Rated current	7 mA	12 mA	12.4 mA	10 mA	7.6 mA	6.8 mA	8.4 mA	8 mA	
Drop-out voltage at 20°C	2.4 V	2.4 V	4.8 V	4.8 V	10 V	10 V	25 V	45 V	
Status device	green LED								
<b>Relay characteristics contact</b>									
Type	1 SPDT								
Voltage switching range min./max.	12 V / 250 V AC								
Current switching range min./max.	10 mA / 6 A								
Load switching range	AC1 min./max.		0.6 VA / 1500 VA (ohmic load)						
	DC1 min./max.		0.6 W / 140 W						
Number of on-load operations	10 <sup>6</sup> on AC15								
Number of off-load operations	10 x 10 <sup>7</sup>								
Operation speed	F	5 ms	5 ms	5 ms	5 ms	5 ms	5 ms	6 ms	7 ms
	O	8 ms	8 ms	15 ms	15 ms	15 ms	15 ms	15 ms	15 ms
Insulation coil / contact	4000 V RMS								
Resistance to shock coil / contact	4000 V RMS								
Insulation contact / contact	1000 V RMS								
Ambient temperature	storage	-40 °C to -80 °C							
	operating	See derating curves							
<b>Other characteristics</b>									
Body material	grey	UL 94 V0							
Wire size	Solid wire	0.2 - 4 mm <sup>2</sup> (24-12 AWG)							
	Stranded wire	0.22 - 2.5 mm <sup>2</sup> (24-12 AWG)							
Rated wire size	2.5 mm <sup>2</sup> (12 AWG)								
Wire stripping length	10 mm (0.394 in)								
Recommended screwdriver	3.5 mm (0.137 in)								
Protection	IP20 NEMA1								
Recommended torque	0.4-0.6 Nm (3.5-5.3 lb.in)								
Approvals	c  us (pending) , 								
Reference standards	CEI 947-7-1 / CEI 947-1 / CEI 1131-2 (in relevant parts) / CEI 60664-1 / CEM : IRC 1000-4-2, 3, 4, 5, 6.								

	DC12	AC12	DC13	AC15
24 V	6 A	6 A	1 A	3 A
110/120 V	0,3 A	6 A	0,2 A	3 A
220/230 V	0,2 A	6 A	0,1 A	3 A

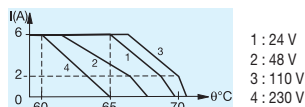
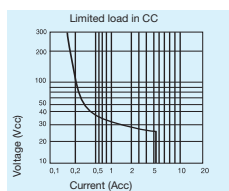

D 2,5/5-R121

### Dimensional drawings

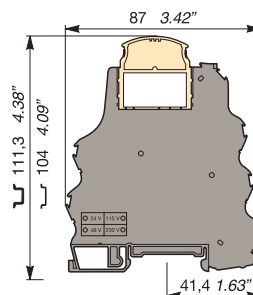

# Optocouplers

## Product group picture

5

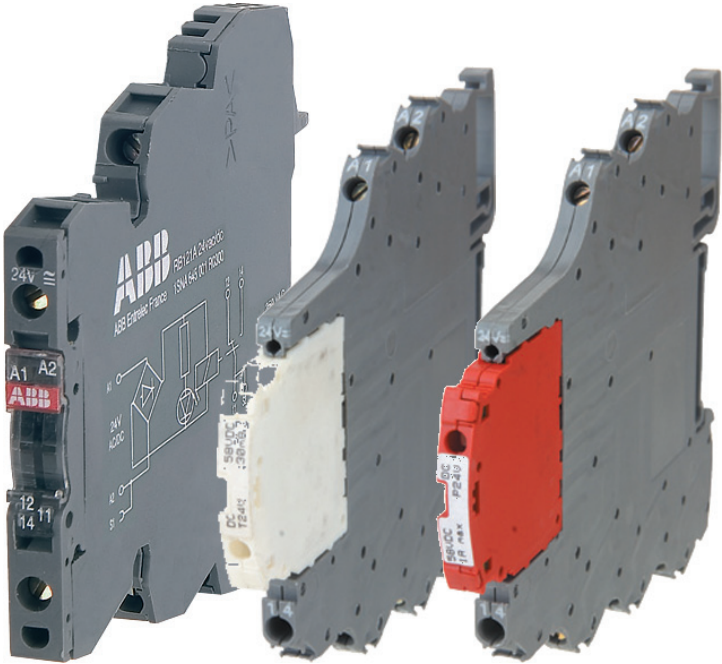

# Optocouplers

## Table of contents

---

<b>Optocouplers</b>	
Optocouplers	5/39
Product group picture	5/39
Table of contents	5/40
<b>R600 Optocouplers</b>	<b>5/41</b>
Selection	5/41
Ordering details	5/43
Connection diagrams	5/44
Technical data	5/45
<b>R500 Optocouplers</b>	<b>5/49</b>
Selection	5/49
Ordering details	5/50
Connection diagrams	5/51
Technical data	5/52

# R600 Optocouplers Selection

Type	Order number
OBIC 0100 5-12VDC	1SNA 645 047 R0000
OBIC 0100 5-12VDC	1SNA 645 547 R0200
OBIC 0100 24VDC	1SNA 645 021 R2600
OBIC 0100 24VDC	1SNA 645 521 R2000
OBIC 0100 48-60VAC/DC	1SNA 645 049 R1200
OBIC 0100 48-60VAC/DC	1SNA 645 549 R1400
OBIC 0100 115-230VAC/DC	1SNA 645 022 R2700
OBIC 0100 115-230VAC/DC	1SNA 645 522 R2100
OBOC 1000-5-12VDC	1SNA 645 050 R1700
OBOC 1000-5-12VDC	1SNA 645 550 R1100
OBOC 1000-24VDC	1SNA 645 051 R0400
OBOC 1500-24VAC/DC	1SNA 645 025 R2200
OBOC 5000-24VDC	1SNA 645 024 R2100
OBOC 1000-24VDC	1SNA 645 551 R0600
OBOC 1500-24VAC/DC	1SNA 645 525 R2400
OBOC 5000-24VDC	1SNA 645 524 R2300
OBOC 1000-48-60VAC/DC	1SNA 645 053 R0600
OBOC 1000-48-60VAC/DC	1SNA 645 553 R0000
OBOC 1000-115VAC/DC	1SNA 645 054 R0700
OBOC 5000-115VAC/DC	1SNA 645 058 R1300
OBOC 1000-115VAC/DC	1SNA 645 554 R0100
OBOC 5000-115VAC/DC	1SNA 645 558 R1500
OBOC 1000-230VAC/DC	1SNA 645 026 R2300
OBOC 5000-230VAC/DC	1SNA 645 059 R1400
OBOC 1000-230VAC/DC	1SNA 645 526 R2500
OBOC 5000-230VAC/DC	1SNA 645 559 R1600
OBOA 1000-24VDC	1SNA 645 027 R2400
OBOA 2000-24VDC	1SNA 645 029 R0600
OBOA 1000-24VDC	1SNA 645 527 R2600
OBOA 2000-24VDC	1SNA 645 529 R0000

Input voltage																				
5 - 12 V DC	■	■																		
24 V DC			■	■																
48 - 60 V DC					■	■														
115 - 230 V DC							■	■												
115 V DC																				
230 V DC																				
24 V AC																				
48 - 60 V AC																				
115-230 V AC																				
115 V AC																				
230 V AC																				

Output rating																				
100 mA	■	■	■	■	■	■	■	■												
2 A																				
5 A																				
1 A																				

Output voltage																				
58 V DC	■	■	■	■	■	■	■	■	■	■	■	■	■	■	■	■	■	■	■	■
400 V AC																				

Terminal type																				
Screw	■		■		■		■		■		■		■		■		■		■	
Spring		■		■		■		■		■		■		■		■		■		■

# R600 Optocouplers Selection

OBOA 1000-48-60VAC/DC	1 SNA 645 061 R0600
OBROA 1000-48-60VAC/DC	1 SNA 645 561 R0000
OBOA 1000-115VAC/DC	1 SNA 645 062 R0700
OBROA 1000-115VAC/DC	1 SNA 645 562 R0100
OBOA 1000-230VAC/DC	1 SNA 645 028 R0500
OBROA 1000-230VAC/DC	1 SNA 645 528 R0700



# R600 Optocouplers

## Ordering details



5

R600 Optocoupler	Type	Order code	Price	Pkg qty	Weight (1 pce) kg (lb)
Optocoupler module 100 mA/DC	OBIC 0100-5-12VDC	1SNA645047R0000		10	0.02 (0.44)
	OBIC 0100-24VDC	1SNA645021R2600			
	OBIC 0100-48-60VAC/DC	1SNA645049R1200			
Optocoupler module 100 mA/DC	OBIC 0100-115-230VAC/DC	1SNA645022R2700		10	0.02 (0.44)
	OBRIC 0100-5-12VDC	1SNA645547R0200			
	OBRIC 0100-24VDC	1SNA645521R2000			
Optocoupler module 100 mA/DC	OBRIC 0100-48-60VAC/DC	1SNA645549R1400		10	0.02 (0.44)
	OBRIC 0100-115-230VAC/DC	1SNA645522R2100			
	OBOC 1000-5-12VDC	1SNA645050R1700			
Optocoupler module 2 A/DC	OBOC 1000-24VDC	1SNA645051R0400		10	0.02 (0.44)
	OBOC 1500-24VAC/DC	1SNA645025R2200			
	OBOC 1000-48-60VAC/DC	1SNA645053R0600			
Optocoupler module 2 A/DC	OBOC 1000-115VAC/DC	1SNA645054R0700		10	0.02 (0.44)
	OBOC 1000-230VAC/DC	1SNA645026R2300			
	OBROC 1000-5-12VDC	1SNA645550R1100			
Optocoupler module 2 A/DC	OBROC 1000-24VDC	1SNA645551R0600		10	0.02 (0.44)
	OBROC 1500-24VAC/DC	1SNA645525R2400			
	OBROC 1000-48-60VAC/DC	1SNA645553R0000			
Optocoupler module 2 A/DC	OBROC 1000-115VAC/DC	1SNA645554R0100		10	0.02 (0.44)
	OBROC 1000-230VAC/DC	1SNA645526R2500			
	OBOC 5000-24VDC	1SNA645024R2100			
Optocoupler module 5 A/DC	OBOC 5000-115VAC/DC	1SNA645058R1300		10	0.02 (0.44)
	OBOC 5000-230VAC/DC	1SNA645059R1400			
	OBROC 5000-24VDC	1SNA645524R2300			
Optocoupler module 5 A/DC	OBROC 5000-115VAC/DC	1SNA645558R1500		10	0.02 (0.44)
	OBROC 5000-230VAC/DC	1SNA645559R1600			
	OBOA 1000-24VDC	1SNA645027R2400			
Optocoupler module 1 A/AC 6 mm spacing	OBOA 1000-48-60VAC/DC	1SNA645061R0600		10	0.03 (0.066)
	OBOA 1000-115VAC/DC	1SNA645062R0700			
	OBOA 1000-230VAC/DC	1SNA645028R0500			
Optocoupler module 2 A/AC 12 mm spacing	OBOA 2000-24VDC	1SNA645029R0600		5	0.03 (0.066)
Optocoupler module 1 A/AC 6 mm spacing	OBROA 1000-24VDC	1SNA645527R2600		10	0.03 (0.066)
	OBROA 1000-48-60VAC/DC	1SNA645561R0000			
	OBROA 1000-115VAC/DC	1SNA645562R0100			
	OBROA 1000-230VAC/DC	1SNA645528R0700			
Optocoupler module 2 A/AC 12 mm spacing	OBROA 2000-24VDC	1SNA645529R0000		5	0.03 (0.066)

Accessories	Type	Order code	Price	Pkg qty	Weight (1 pce) kg (lb)
End section	BADH V0	1SNA116900R2700		50	
	BADL V0	1SNA399903R0200		50	
	BAM2 V0	1SNA399967R0100		50	
Separator end section	SC 612	1SNA290474R0200		10	
Divisible shunt 10 poles	BJ 612-10	1SNA290488R0100		10	
Divisible shunt 70 poles	BJ 612-70	1SNA290489R0200		10	
Screw clamp distribution block sp. 12 mm	D4/12-3-3	1SNA645031R2000		5	
Spring clamp distribution block sp. 12 mm	D4/12-3R-3R	1SNA645531R2200		5	
Test plug DIA. 2 mm	FC2	1SNA645531R2200		10	
Marking method	RC65 / RC610	see marking			

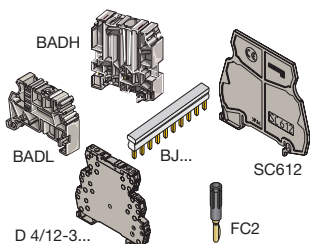

# R600 Optocouplers

## Connection diagrams

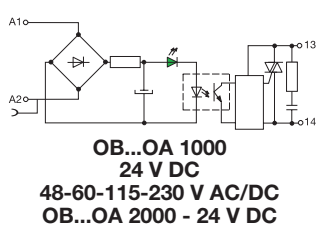
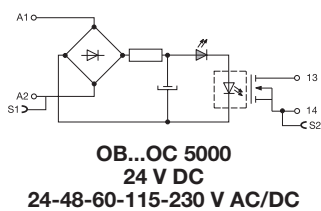
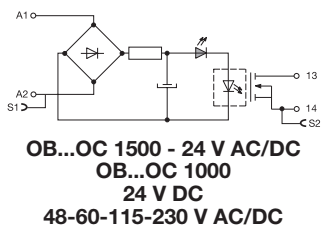
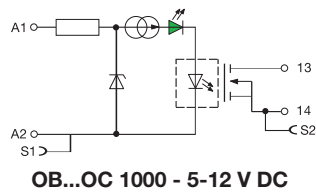
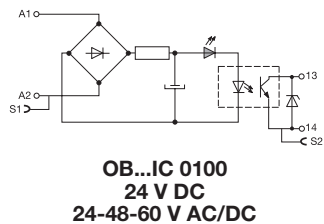
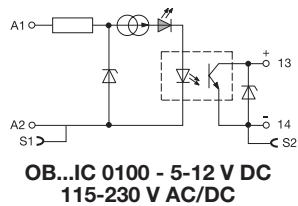





# R600 Optocouplers

## Technical data

### Technical data

Optocoupler : 5 to 58 V DC output / 100 mA - 6 mm 0.236" spacing

5

		OB...IC 0100					
<b>Relay characteristics coil</b>							
Input voltage: +20%, -15% on DC ; 10%, -10% on AC	5 V DC - 12 V DC	24 V DC		48 V AC/DC	60 V AC/DC	115 V AC/DC	230 V AC/DC
Frequency	50 / 60 Hz						
Input current AC/DC	5 mA	9 mA	4 mA	4 mA	5 mA	7 mA / 16 mA	11.5 mA / 25 mA
Pull-in voltage at Is=100%	4 V	15 V		25 V		60 V AC / 70 V DC	
Switching time C / O	10 µs / 500 µs						
Operating frequency	1000 Hz						
Permissible leakage current	20 Hz						
<b>Output</b>	0.9 mA	1 mA		0.9 mA		1.6 mA	
Output voltage	4.5 to 58 V DC						
Output current min.	1 mA						
Output current max.	100 mA						
Output leakage current at U <sub>max</sub>	< 50 µA						
Redidual voltage at I max and U rated	typical	1 V					
	max	1.3 V					
Frequency on inductive load							
Isolation Input / Output	input / Output	2500 V RMS					
Temperature	storage	-40...+80 °C					
	operating	-20...+70 °C <sup>1)</sup>					
<b>Other characteristics</b>		<b>Screw clamp</b>			<b>Spring clamp</b>		
Body material	grey	UL 94 V0					
Wire size	Solid wire	0.2 - 4 mm <sup>2</sup> (24-12 AWG)			0.2-2.5 mm <sup>2</sup> (24-12 AWG)		
	Stranded wire	0.22 - 2.5 mm <sup>2</sup> (24-12 AWG)					
Rated wire size		2.5 mm <sup>2</sup> (12 AWG)					
Wire stripping length		9 mm (0.354 in)					
Recommended screwdriver		3.5 mm (0.137 in)					
Protection		IP20 NEMA1					
Recommended torque		0.4-0.6 Nm (3.5-5.3 lb.in)					
Approvals		c  US (pending for 12 V DC),  (pending),  , LRS, 					
Reference standards		CEI 947-7-1 / CEI 947-1 / CEI 1131-2 (in relevant parts) / CEI 60664-1 / CEM : IRC 1000-4-2, 3, 4, 5, 6.					

<sup>1)</sup> Over 55°C, blocks have to be mounted on horizontal rail with 10 mm spacing between each block. For vertical rail mounting use temperature is 15°C less decreased.

### Dimensional drawings

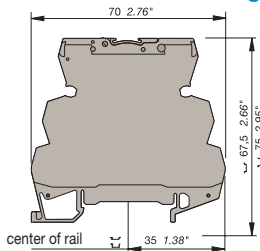

Screw clamp module

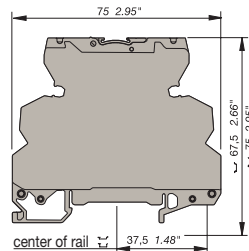

Spring clamp module

# R600 Optocouplers

## Technical data

### Technical data

Optocoupler : 5 to 58 V DC output / 2 A - 6 mm 0.236" spacing

	OB...IC 0100		OB..OC 1500		OB...OC 1000		
<b>Relay characteristics coil</b>							
Input voltage: +20%, -15% on DC ; 10%, -10% on AC	5 V DC - 12 V DC		24 V DC	24 V AC/DC	48 V AC/DC	60 V AC/DC	115 V AC/DC / 230 V AC/DC
Frequency			50 / 60 Hz				
Input current	5 mA	9 mA	4 mA	6.3 mA	4 mA	5.1 mA	4.2 mA / 4 mA
Pull-in voltage at Is=100%	4 V		15 V	15 V	27 V		50 V / 80 V
Switching time C / O	15 $\mu$ s / 250 $\mu$ s		30 $\mu$ s / 400 $\mu$ s	1 ms / 7 ms	5 ms / 20 ms		500 $\mu$ s / 10 ms / 1 ms / 15 ms
Operating frequency	2000 Hz		1000 Hz	60 Hz	20 Hz		
Permissible leakage current	1 mA		0.8 mA	0.9 mA	1 mA		0.3 mA
<b>Output</b>							
Output voltage	4.5 to 58 V DC						
Output current min.	1 mA						
Output current max.	2 A						
Output leakage current at U <sub>max</sub>	< 50 $\mu$ A						
Residual voltage at I max and U rated	typical		0.1 V				
	max		0.5 V				
Frequency on inductive load							
Isolation Input / Output	input / Output		2500 V RMS				
Temperature	storage		-40...+80 °C				
	operating		-20...+70 °C <sup>1)</sup>				
<b>Other characteristics</b>							
Body material	grey		Screw clamp		Spring clamp		
			UL 94 V0				
Wire size	Solid wire		0.2 - 4 mm <sup>2</sup> (24-12 AWG)		0.2-2.5 mm <sup>2</sup> (24-12 AWG)		
	Stranded wire		0.22 - 2.5 mm <sup>2</sup> (24-12 AWG)				
Rated wire size	2.5 mm <sup>2</sup> (12 AWG)						
Wire stripping length	9 mm (0.354 in)						
Recommended screwdriver	3.5 mm (0.137 in)						
Protection	IP20 NEMA1						
Recommended torque	0.4-0.6 Nm (3.5-5.3 lb.in)						
Approvals	UL (pending for 12 V DC) , CE (pending), LRS , CE						
Reference standards	CEI 947-7-1 / CEI 947-1 / CEI 1131-2 (in relevant parts) / CEI 60664-1 / CEM : IRC 1000-4-2, 3, 4, 5, 6.						

<sup>1)</sup> Over 55°C, blocks have to be mounted on horizontal rail with 10 mm spacing between each block. For vertical rail mounting use temperature is 15°C less decreased.

### Dimensional drawings

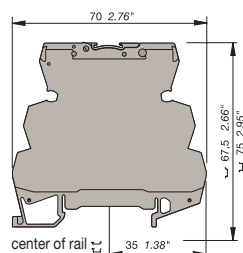

Screw clamp module

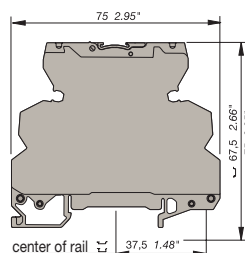



Spring clamp module

# R600 Optocouplers

## Technical data

### Technical data

Optocoupler : 5 to 58 V DC output / 5 A - 6 mm 0.236" spacing

		OB... OC 5000		
<b>Input</b>				
Input voltage		24 V DC	115 V AC/DC	230 V AC/DC
Frequency			50 / 60 Hz	50 / 60 Hz
Input current		5.4 mA	4.2 mA	4 mA
Pull-in voltage at $I_s=100\%$		12 V	50 V	80 V
Switching time C / O		30 $\mu$ s / 400 $\mu$ s	500 $\mu$ s / 10 ms	1ms / 15 ms
Operating frequency		1000 Hz	50 Hz	35 Hz
Permissible leakage current		0.8 mA	0.3 mA	0.3 mA
<b>Output</b>				
Output voltage		4.5- 58 V DC		
Output current min.		25 mA		
Output current max.		1 A		
Output leakage current at $U_{max}$		< 0.50 mA		
Residual voltage at $I_{max}$ and $U_{rated}$	typical	1 V		
	max	1.6 V		
Frequency on inductive load		See Note 1		
Isolation Input / Output	input / Output	2500 V RMS		
<b>Temperature</b>				
Ambient temperature	storage	-40...+80 °C		
	operating	See derating curve		
<b>Other characteristics</b>				
Body material	grey	UL 94 V0		
Wire size	Solid wire	0.2 - 4 mm <sup>2</sup> (24-12 AWG)		
	Stranded wire	0.22 - 2.5 mm <sup>2</sup> (24-12 AWG)		
Rated wire size		2.5 mm <sup>2</sup> (12 AWG)		
Wire stripping length		10 mm (0.394 in)		
Recommended screwdriver		3.5 mm (0.137 in)		
Protection		IP20 NEMA1		
Recommended torque		0.4-0.6 Nm (3.5-5.3 lb.in)		
Approvals		 us (pending), 		
Reference standards		CEI 947-7-1 / CEI 947-1 / CEI 1131-2 (in relevant parts) / CEI 60664-1 / CEM : IRC 1000-4-2, 3, 4, 5, 6.		

### Dimensional drawings

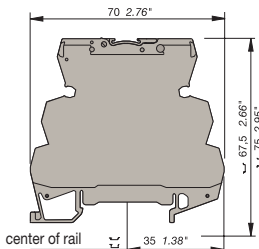

Screw clamp module

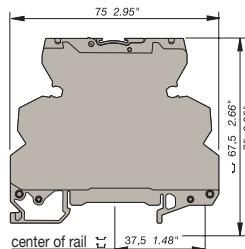





Spring clamp module

# R600 Optocouplers

## Technical data

### Technical data

Optocoupler : 24 to 400 V AC output / 2 A max. - 6 mm or 12 mm spacing

	OB...OA 1000					OB...OA 2000
<b>Relay characteristics coil</b>						
Input voltage: +20%, -15% on DC ; 10%, -10% on AC	24 V DC	48 V AC/DC	60 V AC/DC	115 V AC/DC	230 V AC/DC	24 V DC
Frequency	50/60 Hz					
Input current	3.6 mA	4.3 mA	5.5 mA	4.15 mA	4.6 mA	3.6 mA
Pull-in voltage at Is=100%	14 V	15 V	18 V	60 V	135 V	14 V
Switching time C / O	150 $\mu$ s / 1 ms	3 ms / 30 ms		2.2 ms / 18 ms	2.5 ms / 25 ms	150 $\mu$ s / 1 ms
Operating frequency	500 Hz	20 Hz		25 Hz	20 Hz	500 Hz
Permissible leakage current	1 mA					
<b>Output</b>						
Output voltage	24-58 V AC					
Frequency	50/60 Hz					
Output current min.	25 mA					
Output current max.	1 A					2 mA
Output leakage current at U <sub>max</sub>	< 0.50 mA					
Redidual voltage at I max and U rated	typical					1 V
	max					1.6 V
Frequency on inductive load						
Isolation Input / Output	input / Output	2500 V RMS				
Temperature	storage					-40...+80 °C
	operating					-20...+70 °C <sup>1)</sup>
<b>Other characteristics</b>		<b>Screw clamp</b>		<b>Spring clamp</b>		
Body material	grey	UL 94 V0				
Wire size	Solid wire	0.2 - 4 mm <sup>2</sup> (24-12 AWG)		0.2-2.5 mm <sup>2</sup> (24-12 AWG)		
	Stranded wire	0.22 - 2.5 mm <sup>2</sup> (24-12 AWG)				
Rated wire size		2.5 mm <sup>2</sup> (12 AWG)				
Wire stripping length		9 mm (0.354 in)				
Recommended screwdriver		3.5 mm (0.137 in)				
Protection		IP20 NEMA1				
Recommended torque		0.4-0.6 Nm (3.5-5.3 lb.in)				
Approvals		 (pending for 12 V DC) ,  (pending),  , LRS , 				
Reference standards		CEI 947-7-1 / CEI 947-1 / CEI 1131-2 (in relevant parts) / CEI 60664-1 / CEM : IRC 1000-4-2, 3, 4, 5, 6.				

<sup>1)</sup> Over 55°C, blocks have to be mounted on horizontal rail with 10 mm spacing between each block. For vertical rail mounting use temperature is 15°C less decreased.

### Dimensional drawings

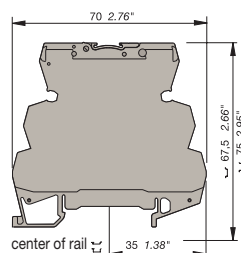

Screw clamp module

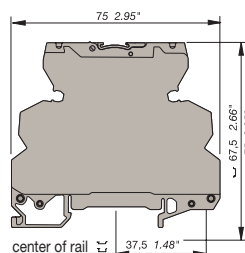

Spring clamp module

# R500 Optocouplers Selection

Type	Order number
D 2,5/5-OBIC-0030-5VDC	1SNA 607 274 R1300
D 2,5/5-OBIC-0030-24VDC	1SNA 607 210 R1700
D 2,5/5-OBIC-0030-48VDC	1SNA 607 211 R0400
D 2,5/5-OBIC-0030-125VDC	1SNA 607 275 R1400
D 2,5/5-OBIA-0030-24VAC	1SNA 607 212 R0500
D 2,5/5-OBIA-0030-48VAC	1SNA 607 213 R0600
D 2,5/5-OBIA-0030-115VAC	1SNA 607 214 R0700
D 2,5/5-OBIA-0030-230VAC	1SNA 607 215 R0000
D 2,5/5-OBOC-0100-5VDC	1SNA 607 203 R1500
D 2,5/5-OBOC-0100-24VDC	1SNA 607 204 R1600
D 2,5/5-OBOC-0100-48VDC	1SNA 607 205 R1700
D 2,5/5-OBOC-1000-5VDC	1SNA 607 206 R1000
D 2,5/5-OBOC-1000-24VDC	1SNA 607 207 R1100
D 2,5/5-OBOC-1000-24VAC/DC	1SNA 607 250 R2700
D 2,5/5-OBOC-1000-48VAC/DC	1SNA 607 251 R1400
D 2,5/5-OBOC-1000-110VAC	1SNA 607 270 R2300
D 2,5/5-OBOC-1000-230VAC	1SNA 607 271 R1000
D 2,5/5-OBOC-2000-5VDC	1SNA 607 208 R2200
D 2,5/5-OBOC-2000-24VDC	1SNA 607 209 R2300
D 2,5/5-OBOC-2000-24VAC/DC	1SNA 607 255 R1000
D 2,5/5-OBOC-2000-48VAC/DC	1SNA 607 256 R1100
D 2,5/5-OBOC-2000-110VAC	1SNA 607 272 R1100
D 2,5/5-OBOC-2000-230VAC	1SNA 607 273 R1200
D 2,5/5-OB0A-1000-24VDC	1SNA 607 238 R1700
D 2,5/5-OB0A-1000-24VAC/DC	1SNA 607 240 R2500
D 2,5/5-OB0A-1000-48VAC/DC	1SNA 607 241 R1200
D 2,5/5-OB0A-1000-110VAC	1SNA 607 268 R2500
D 2,5/5-OB0A-1000-230VAC	1SNA 607 269 R2600

Input voltage	
5 V DC	■
24 V DC	■
48 V DC	■
125 V DC	■
24 V AC	■
48 V AC	■
110 V AC	■
115 V AC	■
230 V AC	■

Output rating	
30 mA	■
100 mA	■
2 A	■
1 A	■

Output voltage	
30 V DC	■
58 V DC	■
253 V AC	■

Type	
input optocoupler	■
output optocoupler	■



# R500 Optocouplers

## Ordering details



Description of R600 Optocoupler	Type	Order code	Price	Pkg qty	Weight (1 pce) kg (lb)
Optocoupler module 30 mA/DC	D 2,5/5-OBIC-0030-5VDC	1SNA607274R1300		1	0.032 (0.071)
	D 2,5/5-OBIC-0030-24VDC	1SNA607210R1700			
	D 2,5/5-OBIC-0030-48VDC	1SNA607211R0400			
	D 2,5/5-OBIC-0030-125VDC	1SNA607275R1400			
Optocoupler module 30 mA/AC	D 2,5/5-OBIA-0030-24VAC	1SNA607212R0500		1	0.032 (0.071)
	D 2,5/5-OBIA-0030-48VAC	1SNA607213R0600			
	D 2,5/5-OBIA-0030-115VAC	1SNA607214R0700			
	D 2,5/5-OBIA-0030-230VAC	1SNA607215R0000			
Optocoupler module 100 mA/DC	D 2,5/5-OBOC-0100-5VAC	1SNA607203R1500		1	0.032 (0.071)
	D 2,5/5-OBOC-0100-24VAC	1SNA607204R1600			
	D 2,5/5-OBOC-0100-48VAC	1SNA607205R1700			
Optocoupler module 1 A/DC	D 2,5/5-OBOC-1000-5VDC	1SNA607206R1000		1	0.04 (0.088)
	D 2,5/5-OBOC-1000-24VDC	1SNA607207R1100			
	D 2,5/5-OBOC-1000-24VAC/DC	1SNA607250R2700			
	D 2,5/5-OBOC-1000-48VAC/DC	1SNA607251R1400			
	D 2,5/5-OBOC-1000-110VAC	1SNA607270R2300			
	D 2,5/5-OBOC-1000-230VAC	1SNA607271R1000			
Optocoupler module 2 A/DC	D 2,5/5-OBOC-2000-5VDC	1SNA607208R2200		1	0.04 (0.088)
	D 2,5/5-OBOC-2000-24VDC	1SNA607209R2300			
	D 2,5/5-OBOC-2000-24VAC/DC	1SNA607255R1000			
	D 2,5/5-OBOC-2000-48VAC/DC	1SNA607256R1100			
Optocoupler module 1 A/DC	D 2,5/5-OBOC-2000-110VAC	1SNA607272R1100		1	0.04 (0.088)
	D 2,5/5-OBOC-2000-230VAC	1SNA607273R1200			
	D 2,5/5-OBOA-1000-24VAC	1SNA607238R1700			
	D 2,5/5-OBOA-1000-24VAC/DC	1SNA607240R2500			
	D 2,5/5-OBOA-1000-48VAC/DC	1SNA607241R1200			
Optocoupler module 1 A/DC	D 2,5/5-OBOA-1000-110VAC	1SNA607268R2500		1	0.04 (0.088)
	D 2,5/5-OBOA-1000-230VAC	1SNA607269R2600			
	D 2,5/5-OBOA-1000-230VAC	1SNA607269R2600			

5

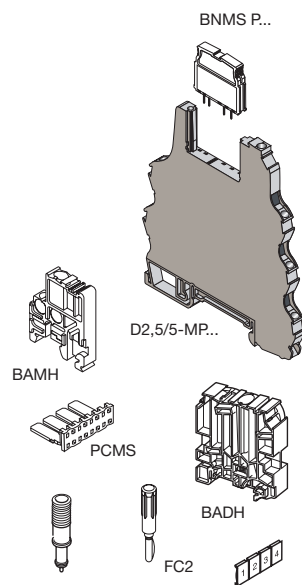

Description of Accessories	Type	Order code	Price	Pkg qty	Weight (1 pce) kg (lb)
High end stop	BAMH 9.1 mm	1SNA114836R0000		50	
	BAMH V0 9.1 mm	1SNA194836R0100			
	BADH 12 mm	1SNA116900R2700			
Comb type jumper bar 2 to 22 poles		consult us			
Jumper bar 10 poles grey	PCMS V0	1SNA205523R2200		8	
Input opto base	D 2.5-5-MP1	1SNA607223R0000		10	0.028 (0.062)
Plug OBIC 5 V white	BNMS T5V-1	1SNA031831R0300		4	
Plug OBIC 24 V white	BNMS T24V-1	1SNA031800R2100			
Plug OBIC 48 V white	BNMS T48V-1	1SNA031801R1600			
Plug OBIC 125 V white	BNMS T125V-1	1SNA031845R1100			
Test device blue	DCB (1)	1SNA105028R2100		10	
Test plug DIA 2 mm	FC2	1SNA105028R2100			
Marking method	RC55	see marking			

# R500 Optocouplers

## Connection diagrams

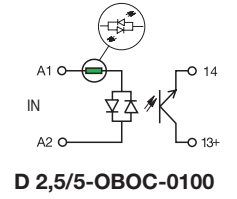
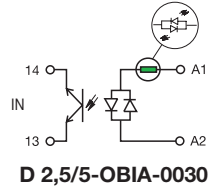
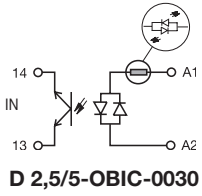

5

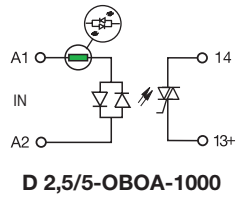
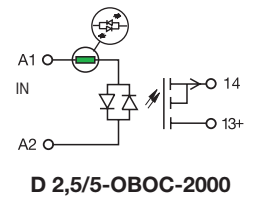
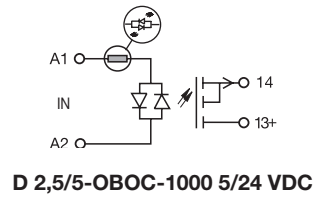
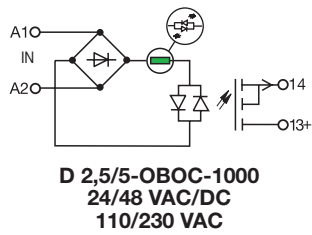



# R500 Optocouplers

## Technical data

### Technical data

Pluggable optocoupler : 5 to 58 V DC output / 30 mA - 5.08 mm 0.200" spacing

		D 2,5/5-OBIC-0030			
<b>Input</b>					
Input voltage		4.5 V to 5.5 VDC	19.2 V to 27.6 VDC	38.4 V to 55.2 VDC	93.5 V to 140 VDC
Input current		6 mA	5 mA	4.1 mA	3 mA
Pull-in voltage at $I_s=100\%$		3.5 V	12 V	21 V	50 V
Switching time C / O		20 $\mu$ s / 1.3 ms			
Operating frequency		400 Hz			
Permissible leakage current			1 mA	0.8 mA	
<b>Output</b>					
Output voltage		4.5 to 58 V DC			
Output current min.		0.5 mA			
Output current max.		30 mA			
Output leakage current at $U_{max}$		< 50 $\mu$ A			
Redidual voltage at $I_{max}$ and $U_{rated}$	typical	2.3 V DC			
	max	2.7 V DC			
Frequency on inductive load					
Isolation Input / Output	input / Output	2500 V RMS			
Ambient temperature	storage	-40...+80 °C			
	operating	See derating curve			
<b>Other characteristics</b>					
Body material	grey	UL 94 V0			
Wire size	Solid wire	0.2 - 4 mm <sup>2</sup> (24-12 AWG)			
	Stranded wire	0.22 - 2.5 mm <sup>2</sup> (24-12 AWG)			
Rated wire size		2.5 mm <sup>2</sup> (12 AWG)			
Wire stripping length		9 mm (0.354 in)			
Recommended screwdriver		3.5 mm (0.137 in)			
Protection		IP20 NEMA1			
Recommended torque		0.4-0.6 Nm (3.5-5.3 lb.in)			
Approvals		c  us (pending), 			
Reference standards		CEI 947-7-1 / CEI 947-1 / CEI 1131-2 (in relevant parts) / CEI 60664-1 / CEM : IRC 1000-4-2, 3, 4, 5, 6.			

5

### Derating curve

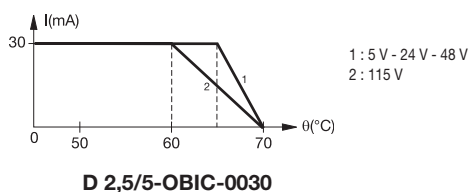

### Dimensional drawings

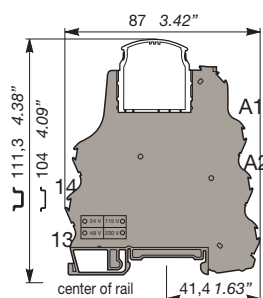



# R500 Optocouplers

## Technical data

### Technical data

Pluggable optocoupler : 5 to 58 V DC output / 30 mA - 5.08 mm 0.200" spacing

5

		D 2,5/5-OBIA-0030			
<b>Input</b>					
Input voltage		20.4 to 26.4 V AC	40.8 V to 52.8 V AC	98 V to 126.5 V AC	195.5 V to 253 V AC
Input current		8.5 mA	4.5 mA	8 mA	7 mA
Pull-in voltage at Is=100%		13 V	22 V	50 V	95 V
Switching time C / O		6 ms / 10 ms			
Operating frequency		30 Hz			
Permissible leakage current		1 mA		2 mA	
<b>Output</b>					
Output voltage		4.5 V to 58 V DC			
Output current min.		0.5 mA			
Output current max.		30 mA			
Output leakage current at U <sub>max</sub>		< 50 µA			
Residual voltage at I max and U rated	typical	2.3 V DC			
	max	2.7 V DC			
Frequency on inductive load		2500 V RMS			
Isolation Input / Output	input / Output				
<b>Temperature</b>					
Ambient temperature	storage	-40...+80 °C			
	operating	See derating curve			
<b>Other characteristics</b>					
Body material	grey	UL 94 V0			
Wire size	Solid wire	0.2 - 4 mm <sup>2</sup> (24-12 AWG)			
	Stranded wire	0.22 - 2.5 mm <sup>2</sup> (24-12 AWG)			
Rated wire size		2.5 mm <sup>2</sup> (12 AWG)			
Wire stripping length		9 mm (0.354 in)			
Recommended screwdriver		3.5 mm (0.137 in)			
Protection		IP20 NEMA1			
Recommended torque		0.4-0.6 Nm (3.5-5.3 lb.in)			
Approvals		 (pending), 			
Reference standards		CEI 947-7-1 / CEI 947-1 / CEI 1131-2 (in relevant parts) / CEI 60664-1 / CEM : IRC 1000-4-2, 3, 4, 5, 6.			

### Derating curve

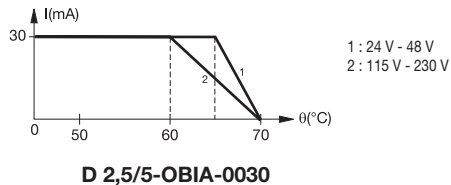

### Dimensional drawings

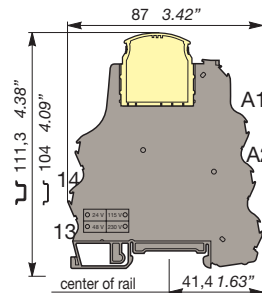



# R500 Optocouplers

## Technical data

### Technical data

Pluggable optocoupler : 5 to 58 V DC output / 100 mA - 5.08 mm 0.200" spacing

	D 2,5/5-OBIA-0100 5 V DC / 24 V DC		D 2,5/5-OBIA-0100 48 V DC
<b>Input</b>			
Input voltage	4.5 V to 5.5 V DC	20.4 V to 28.8 V DC	40.8 V to 57.6 V DC
Frequency			
Input current	8.5 mA	4.8 mA	3.9 mA
Pull-in voltage at Is=100%	2.9 V DC	16 V DC	26 V DC
Switching time C / O		20 μs / 1.3 ms	
Operating frequency		400 Hz	
Permissible leakage current		1 mA	
<b>Output</b>			
Output voltage		4.5 V to 58 V DC	
Output current min.		1 mA	
Output current max.		100 mA	
Output leakage current at U <sub>rrmax</sub>		< 50 μA	
Redidual voltage at I max and U rated	typical	1 V DC	
	max	1.3 V DC	
Frequency on inductive load		See Note 1	
Isolation Input / Output	input / Output	2500 V RMS	
<b>Temperature</b>			
Ambient temperature	storage	-40...+80 °C	
	operating	See derating curve	
<b>Other characteristics</b>			
Body material	grey	UL 94 V0	
Wire size	Solid wire	0.2 - 4 mm <sup>2</sup> (24-12 AWG)	
	Stranded wire	0.22 - 2.5 mm <sup>2</sup> (24-12 AWG)	
Rated wire size		2.5 mm <sup>2</sup> (12 AWG)	
Wire stripping length		9 mm (0.354 in)	
Recommended screwdriver		3.5 mm (0.137 in)	
Protection		IP20 NEMA1	
Recommended torque		0.4-0.6 Nm (3.5-5.3 lb.in)	
Approvals		c  us (pending), 	
Reference standards		CEI 947-7-1 / CEI 947-1 / CEI 1131-2 (in relevant parts) / CEI 60664-1 / CEM : IRC 1000-4-2, 3, 4, 5, 6.	

5

#### Note 1 :

$$F_{max} = (1 - 0,007 \times U_s) / (L \times I_s^2)$$

or

$$F_{max} = (1 - 0,007 \times U_s) / (P \times \frac{L}{R})$$

U<sub>s</sub> = Output voltage  
 I<sub>s</sub> = Output current  
 L = Inductance of load  
 P = Power of load  
 R = Resistance of load

#### Derating curve

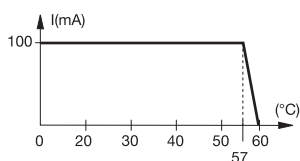

D 2,5/5-OBOC-0100 5 V DC / 24 V DC

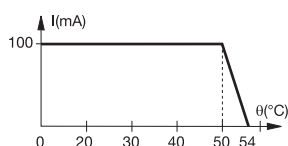

D 2,5/5-OBOC-0100 48 V DC

#### Dimensional drawings

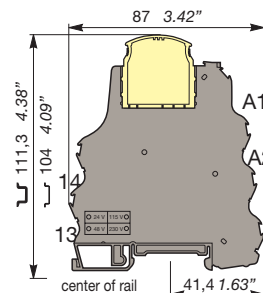

# R500 Optocouplers

## Technical data

### Technical data

Pluggable optocoupler : 5 to 58 V DC output / 1 A - 5.08 mm 0.200" spacing

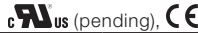
	D 2,5/5-OBOC-1000 5/24 V DC		D 2,5/5-OBOC-1000 24/48 V AC/DC				D 2,5/5-OBOC-1000 110/230 V AC	
	5 V DC	24 V DC	24 V AC	24 V DC	48 V AC	48 V DC	110 V AC	230 V AC
<b>Input</b>	5 V DC	24 V DC	24 V AC	24 V DC	48 V AC	48 V DC	110 V AC	230 V AC
Input voltage	4.5 - 5.5 V DC	20.4 - 28.8 V DC	24 ± 10 %	20.4 - 28.8 V DC	48 ± 10 %	40.8 to 57.6 V DC	110 ± 10 %	230 ± 10 %
Frequency			50 / 60 Hz		50 / 60 Hz		50 / 60 Hz	50 / 60 Hz
Input current	12.3 mA	6.7 mA	10.5 mA	8 mA	6.8 mA	5.8 mA	8.5 mA	7.5 mA
Pull-in voltage at Is=100%	3.5 V DC	10 V DC						
Switching time C / O	20 / 250 µs	50 / 350 µs	15 / 13 ms	5 / 13 ms	15 / 15 ms	6 / 25 ms	15 / 15 ms	15 / 15 ms
Operating frequency	2000 Hz	1500 Hz			20 Hz			
Permissible leakage current								
<b>Output</b>								
Output voltage	4.5 V to 58 V DC							
Output current min.	1 mA							
Output current max.	1 A							
Output leakage current at U <sub>max</sub>	< 50 µA							
Residual voltage at I max and U rated	typical		0.1 V DC					
	max		0.5 V DC					
Frequency on inductive load	See Note 1							
Isolation Input / Output	input / Output	2500 V RMS						
<b>Temperature</b>								
Ambient temperature	storage		-40...+80 °C					
	operating		See derating curve					
<b>Other characteristics</b>								
Body material	grey		UL 94 V0					
Wire size	Solid wire		0.2 - 4 mm <sup>2</sup> (24-12 AWG)					
	Stranded wire		0.22 - 2.5 mm <sup>2</sup> (24-12 AWG)					
Rated wire size	2.5 mm <sup>2</sup> (12 AWG)							
Wire stripping length	10 mm (0.394 in)							
Recommended screwdriver	3.5 mm (0.137 in)							
Protection	IP20 NEMA1							
Recommended torque	0.4-0.6 Nm (3.5-5.3 lb.in)							
Approvals								
Reference standards	CEI 947-1 / CEI 947-1 / CEI 1131-2 (in relevant parts) / CEI 60664-1 / CEM : IRC 1000-4-2, 3, 4, 5, 6.							

#### Note 1 :

$$I_{max} = (1 - 0,007 \times U_s) / (L \times I_s^2)$$

or

$$I_{max} = (1 - 0,007 \times U_s) / (P \times \frac{L}{R})$$

U<sub>s</sub> = Output voltage

I<sub>s</sub> = Output current

L = Inductance of load

P = Power of load

R = Resistance of load

### Derating curve

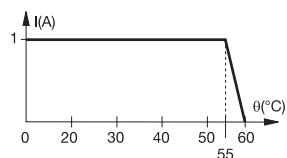

### Dimensional drawings

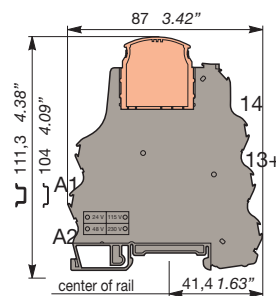



# R500 Optocouplers

## Technical data

### Technical data

Pluggable optocoupler : 5 to 30 V DC output / 2 A - 5.08 mm 0.200" spacing

	D 2,5/5-OBOC-2000 5/24 V DC		D 2,5/5-OBOC-2000 24/48 V AC/DC				D 2,5/5-OBOC-2000 110/230 V AC	
Input	5 V DC	24 V DC	24 V AC	24 V DC	48 V AC	48 V DC	110 V AC	230 V AC
Input voltage	4.5 - 5.5 V DC	20.4 - 28.8 V DC	24 ± 10 %	20.4 - 28.8 V DC	48 ± 10 %	40.8 to 57.6 V DC	110 ± 10 %	230 ± 10 %
Frequency			50 / 60 Hz		50 / 60 Hz		50 / 60 Hz	50 / 60 Hz
Input current	12.3 mA	6.7 mA	10.5 mA	8 mA	6.8 mA	5.8 mA	8.5 mA	7.5 mA
Pull-in voltage at Is=100%	3.5 V DC	10 V DC						
Switching time C / O	20 / 250 µs	50 / 350 µs	15 / 13 ms	5 / 13 ms	15 / 15 ms	6 / 25 ms	15 / 15 ms	15 / 15 ms
Operating frequency	2000 Hz	1500 Hz			20 Hz			
Permissible leakage current								
<b>Output</b>								
Output voltage	4.5 V to 58 V DC							
Output current min.	1 mA							
Output current max.	2 A							
Output leakage current at U <sub>max</sub>	< 50 µA							
Residual voltage at I max and U rated	typical		0.1 V DC					
	max		0.5 V DC					
Frequency on inductive load	See Note 1							
Isolation Input / Output	input / Output		2500 V RMS					
<b>Temperature</b>								
Ambient temperature	storage		-40...+80 °C					
	operating		See derating curve					
<b>Other characteristics</b>								
Body material	grey		UL 94 V0					
Wire size	Solid wire		0.2 - 4 mm <sup>2</sup> (24-12 AWG)					
	Stranded wire		0.22 - 2.5 mm <sup>2</sup> (24-12 AWG)					
Rated wire size	2.5 mm <sup>2</sup> (12 AWG)							
Wire stripping length	10 mm (0.394 in)							
Recommended screwdriver	3.5 mm (0.137 in)							
Protection	IP20 NEMA1							
Recommended torque	0.4-0.6 Nm (3.5-5.3 lb.in)							
Approvals	 us (pending), 							
Reference standards	CEI 947-7-1 / CEI 947-1 / CEI 1131-2 (in relevant parts) / CEI 60664-1 / CEM : IRC 1000-4-2, 3, 4, 5, 6.							

5

#### Note 1 :

$$F_{max} = (1 - 0,012 \times U_s) / (L \times I_s^2)$$

or

$$F_{max} = (1 - 0,012 \times U_s) / (P \times \frac{L}{R})$$

U<sub>s</sub> = Output voltage  
 I<sub>s</sub> = Output current  
 L = Inductance of load  
 P = Power of load  
 R = Resistance of load

#### Derating curve

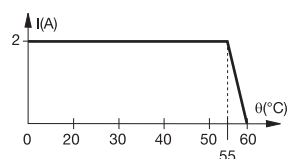

#### Dimensional drawings

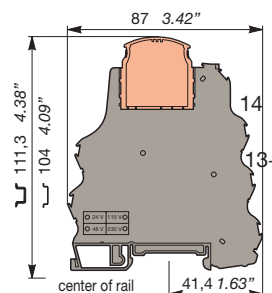

# R500 Optocouplers

## Technical data

### Technical data

Pluggable optocoupler : 24 to 253 V AC output / 1 A - 5.08 mm 0.200" spacing

	D 2,5/5-... 24 V DC	D 2,5/5-OBOA-1000 24 V AC/DC - 48 V AC/DC				D 2,5/5-OBOA-1000 110 V AC - 230 V AC	
<b>Input</b>	24 V DC	24 V AC	24 V DC	48 V AC	48 V DC	110 V AC	230 V AC
Input voltage	20.4 - 28.8 V DC	24 ± 10 %	20.6 - 28.8 V DC	48 ± 10 %	40.8 - 57.6 V DC	110 ± 10 %	230 ± 10 %
Frequency		50 / 60 Hz		50 / 60 Hz		50 / 60 Hz	50 / 60 Hz
Input current	4 mA	10 mA	7 mA	6 mA	5 mA	8 mA	7.5 mA
Pull-in voltage at Is=100%							
Switching time C / O	10/20 ms	20/20 ms	10/20 ms	20/20 ms	10/20 ms	20/20 ms	20/20 ms
Operating frequency				15 Hz			
Permissible leakage current							
<b>Output</b>							
Output voltage	24-253 V AC - 50/60 Hz						
Output current min.	25 mA						
Output current max.	1 A						
Output leakage current at U <sub>max</sub>	< 0.50 mA						
Residual voltage at I max and U rated	typical	1 V					
	max	1.6 V					
Frequency on inductive load	See Note 1						
Isolation Input / Output	input / Output	2500 V RMS					
<b>Temperature</b>							
Ambient temperature	storage	-40...+80 °C					
	operating	See derating curve					
<b>Other characteristics</b>							
Body material	grey	UL 94 V0					
Wire size	Solid wire	0.2 - 4 mm <sup>2</sup> (24-12 AWG)					
	Stranded wire	0.22 - 2.5 mm <sup>2</sup> (24-12 AWG)					
Rated wire size		2.5 mm <sup>2</sup> (12 AWG)					
Wire stripping length		10 mm (0.394 in)					
Recommended screwdriver		3.5 mm (0.137 in)					
Protection		IP20 NEMA1					
Recommended torque		0.4-0.6 Nm (3.5-5.3 lb.in)					
Approvals		UL us (pending), CE					
Reference standards		CEI 947-7-1 / CEI 947-1 / CEI 1131-2 (in relevant parts) / CEI 60664-1 / CEM : IRC 1000-4-2, 3, 4, 5, 6.					

#### Note 1 :

$$F_{max} = (1 - 0,012 \times U_s) / (L \times I_s^2)$$

or

$$F_{max} = (1 - 0,012 \times U_s) / (P \times \frac{L}{R})$$

U<sub>s</sub> = Output voltage

I<sub>s</sub> = Output current

L = Inductance of load

P = Power of load

R = Resistance of load

### Derating curve

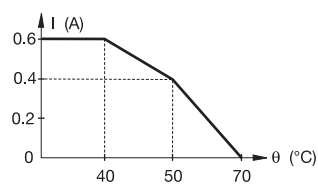

### Dimensional drawings

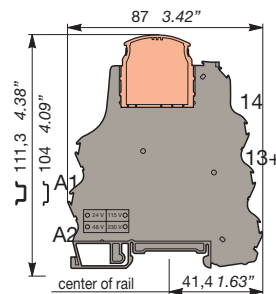



# Interface Relays and Optocouplers Accessories

## Table of Contents

<b>Interface Relays and Optocouplers Accessories</b>	
Table of Contents	5/58
R500 series component holder terminal blocks	5/59
Input optocoupler plugs	5/60
Transistor or MOS output optocoupler plugs	5/61
MOS or Triac output optocoupler plugs	5/62
Relay or analog plugs, fuse and strap plugs	5/63
Accessories	5/64
Accessories	5/65
Marking	5/66

# Terminal blocks component holder

Base for pluggable plug  
R500 Series

DIN 3

End stop		th. 9 mm	BADL	V0	1SNA 399 903 R0200
End stop		th. 9,1 mm	BAM	V2	1SNA 103 002 R2600
End stop		th. 9,1 mm	BAM V0	V0	1SNA 199 306 R0300
Rail		35 x 7,5 x 1	PR3.Z2		1SNA 174 300 R1700
Rail		35 x 15 x 2,3	PR4		1SNA 168 500 R1200
Rail		35 x 15 x 1,5	PR5		1SNA 168 700 R2200

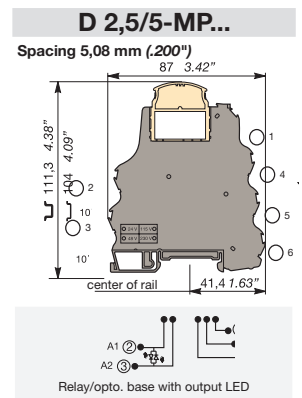
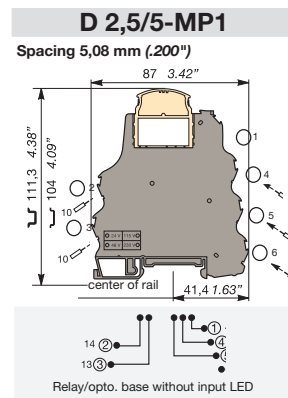
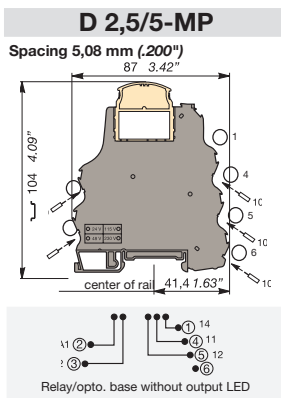

## Observations

Terminal blocks are delivered without plugs.

Max. working temperature  
version without LED : 100°C  
version with LED : 85°C  
Contact resistance : < 5 mΩ

Type	Part numbers	Type	Part numbers	Type	Part numbers
Grey V0	Order plugs separately	Grey V0	Order plugs separately	Grey V0	Order plugs separately
D 2,5/5-MP	1SNA607224R0100	D 2,5/5-MP1	1SNA607223R0000	D 2,5/5-MP-24VDC	1SNA607222R0700
				D 2,5/5-MP-24VAC/DC	1SNA607260R2100
				D 2,5/5-MP-48VAC/DC	1SNA607261R1600
				D 2,5/5-MP-110VAC	1SNA607266R1300
				D 2,5/5-MP-230VAC	1SNA607267R1400

## Characteristics

Wire size	Compression clamp	Solid wire	IEC	UL/CSA pending	Wire size	Compression clamp	Solid wire	IEC	UL/CSA pending	Wire size	Compression clamp	Solid wire	IEC	UL/CSA pending
			0,2-4 mm <sup>2</sup>	24-12 AWG				0,2-4 mm <sup>2</sup>	24-12 AWG				0,2-4 mm <sup>2</sup>	24-12 AWG
		Stranded wire	0,22-2,5 mm <sup>2</sup>	24-12 AWG				0,22-2,5 mm <sup>2</sup>	24-12 AWG				0,22-2,5 mm <sup>2</sup>	24-12 AWG
	Rated		320 V	300 V		Rated		320 V	300 V		Rated		320 V	300 V
	Pulse		4 kV			Pulse		4 kV			Pulse		4 kV	
	Pollution degree		3			Pollution degree		3			Pollution degree		3	
	Rated		6 A	6 A		Rated		6 A	6 A		Rated		6 A	6 A
Wire size	Rated / Gauge		2,5 mm <sup>2</sup>	12 AWG	Wire size	Rated / Gauge		2,5 mm <sup>2</sup>	12 AWG	Wire size	Rated / Gauge		2,5 mm <sup>2</sup>	12 AWG
Wire stripping length			10 mm / .394"		Wire stripping length			10 mm / .394"		Wire stripping length			10 mm / .394"	
Recommended screwdriver			3,5 mm / .137"		Recommended screwdriver			3,5 mm / .137"		Recommended screwdriver			3,5 mm / .137"	
Recommended torque			0,4-0,6 Nm / 3,5-5,3 lb.in		Recommended torque			0,4-0,6 Nm / 3,5-5,3 lb.in		Recommended torque			0,4-0,6 Nm / 3,5-5,3 lb.in	
Protection			IP 20 / NEMA1		Protection			IP 20 / NEMA1		Protection			IP 20 / NEMA1	

## Accessories

	Type	Part numbers	Type	Part numbers	Type	Part numbers
1 Test device	DCB (1) blue	1SNA105028R2100	DCB (1) blue	1SNA105028R2100	DCB (1) blue	1SNA105028R2100
2 Test plug	FC2 DIA. 2	1SNA007865R2600	FC2 DIA. 2	1SNA105028R2100	FC2 DIA. 2	1SNA007865R2600
3 Relay plug 1 SPDT 10 mA/6 A	BNMS R24V-1 beige	1SNA031820R1400	BNMS R24V-1 beige	1SNA007865R2600	BNMS R24V-1 beige	1SNA031820R1400
3 Relay plug 1 SPDT 1 mA/6 A	BNMS R24V-2 beige	1SNA031847R1300	BNMS R24V-2 beige	1SNA031847R1300	BNMS R24V-2 beige	1SNA031847R1300
4 Input optocoupler plug 5 V DC	BNMS N24V-3 red	1SNA031807R1400	BNMS T5V-1 white	1SNA031831R0300	BNMS N24V-3 red	1SNA031807R1400
24 V DC	BNMS P24V-3 red	1SNA031810R1200	BNMS T24V-1 white	1SNA031848R2400	BNMS P24V-3 red	1SNA031810R1200
24 V DC	BNMS N24V-1 red	1SNA031813R0100	BNMS T24V-2 white	1SNA031800R2100	BNMS N24V-1 red	1SNA031813R0100
48 V DC	BNMS P24V-1 red	1SNA031815R0300	BNMS T48V-1 white	1SNA031801R1600	BNMS P24V-1 red	1SNA031815R0300
125 V DC	BNMS N24V-2 red	1SNA031817R0500	BNMS T125V-1 white	1SNA031845R1100	BNMS N24V-2 red	1SNA031817R0500
24 V AC	BNMS P24V-2 red	1SNA031819R1700	BNMS T125V-2 yellow	1SNA031802R1700	BNMS P24V-2 red	1SNA031819R1700
48 V AC	BNMS A24V-4 black	1SNA031839R1300	BNMS T48V-1 yellow	1SNA031803R1000	BNMS A24V-4 black	1SNA031839R1300
115 V AC	BNMS N5V-3 red	1SNA031806R1300	BNMS T115V-1 yellow	1SNA031804R1100	BNMS N5V-3 red	1SNA031806R1300
230 V AC	BNMS P5V-3 red	1SNA031809R2600	BNMS T230V-1 yellow	1SNA031805R1200	BNMS P5V-3 red	1SNA031809R2600
5 Output optocoupler 24 V DC/100 mA	BNMS N48V-3 red	1SNA031808R2500			BNMS N48V-3 red	1SNA031808R2500
24 V DC/100 mA	BNMS P48V-3 red	1SNA031811R0700			BNMS P48V-3 red	1SNA031811R0700
24 V DC/2 A	BNMS N5V-1 red	1SNA031812R0000			BNMS N5V-1 red	1SNA031812R0000
24 V DC/2 A	BNMS P5V-1 red	1SNA031814R0200			BNMS P5V-1 red	1SNA031814R0200
24 V DC/1 A	BNMS N5V-2 red	1SNA031816R0400			BNMS N5V-2 red	1SNA031816R0400
24 V DC/1 A	BNMS P5V-2 red	1SNA031818R1600			BNMS P5V-2 red	1SNA031818R1600
5 Output optocoupler 5 V DC/100 mA	BNMS F125mA-1 grey	1SNA031821R0100	BNMS F125mA-1 grey	1SNA031821R0100	BNMS F125mA-1 grey	1SNA031821R0100
5 V DC/100 mA	BNMS F500mA-1 grey	1SNA031838R1200	BNMS F500mA-1 grey	1SNA031838R1200	BNMS F500mA-1 grey	1SNA031838R1200
48 V DC/100 mA	BNMS F2A-1 grey	1SNA031822R0200	BNMS F2A-1 grey	1SNA031822R0200	BNMS F2A-1 grey	1SNA031822R0200
48 V DC/100 mA	BNMS F5A-1 grey	1SNA031823R0300	BNMS F5A-1 grey	1SNA031823R0300	BNMS F5A-1 grey	1SNA031823R0300
5 V DC/2 A	BNMS F125mA-2 grey	1SNA031824R0400	BNMS F125mA-2 grey	1SNA031824R0400	BNMS F125mA-2 grey	1SNA031824R0400
5 V DC/2 A	BNMS F2A-2 grey	1SNA031825R0500	BNMS F2A-2 grey	1SNA031825R0500	BNMS F2A-2 grey	1SNA031825R0500
5 V DC/1 A	BNMS F5A-2 grey	1SNA031826R0600	BNMS F5A-2 grey	1SNA031826R0600	BNMS F5A-2 grey	1SNA031826R0600
5 V DC/1 A	BNMS F125mA-3 grey	1SNA031827R0700	BNMS F125mA-3 grey	1SNA031827R0700	BNMS F125mA-3 grey	1SNA031827R0700
5 V DC/1 A	BNMS F125mA-4 grey	1SNA031828R1000	BNMS F125mA-4 grey	1SNA031828R1000	BNMS F125mA-4 grey	1SNA031828R1000
7 Fuse plug 125 V/125 mA	BNMS F2A-7 grey	1SNA031849R2500	BNMS F2A-7 grey	1SNA031849R2500	BNMS F2A-7 grey	1SNA031849R2500
125 V/500 mA	BNMS ST1 grey	1SNA031829R1100	BNMS ST1 grey	1SNA031829R1100	BNMS ST1 grey	1SNA031829R1100
125 V/2 A	BNMS ST2 grey	1SNA031830R1600	BNMS ST2 grey	1SNA031830R1600	BNMS ST2 grey	1SNA031830R1600
125 V/5 A	BNMS CAI/U-500 grey	1SNA031832R0400	BNMS CAI/U-500 grey	1SNA031832R0400	BNMS CAI/U-500 grey	1SNA031832R0400
250 V/125 mA	BNMS CAI/U-500 grey	1SNA031832R0400	BNMS CAI/U-500 grey	1SNA031832R0400	BNMS CAI/U-500 grey	1SNA031832R0400
250 V/2 A	BNMS CAI/U-250 grey	1SNA031833R0500	BNMS CAI/U-250 grey	1SNA031833R0500	BNMS CAI/U-250 grey	1SNA031833R0500
250 V/5 A	BNMS CAI/U-250 grey	1SNA031833R0500	BNMS CAI/U-250 grey	1SNA031833R0500	BNMS CAI/U-250 grey	1SNA031833R0500
125 V/125 mA	BNMS CAI/U-250 grey	1SNA031833R0500	BNMS CAI/U-250 grey	1SNA031833R0500	BNMS CAI/U-250 grey	1SNA031833R0500
250 V/125 mA	BNMS CAI/U-250 grey	1SNA031833R0500	BNMS CAI/U-250 grey	1SNA031833R0500	BNMS CAI/U-250 grey	1SNA031833R0500
125 V/2 A	BNMS CAI/U-250 grey	1SNA031833R0500	BNMS CAI/U-250 grey	1SNA031833R0500	BNMS CAI/U-250 grey	1SNA031833R0500
8 Strap plug	PCMS V0 (2) RC 55	1SNA205523R2200	PCMS V0 (2) RC 55	1SNA205523R2200	PCMS V0 (2) RC 55	1SNA205523R2200
9 Converter plug 0-20 mA/0-10 V						
4-20 mA/2-10 V						
0-20 mA/0-5 V						
4-20 mA/1-5 V						
10 Comb type jumper bar 10 poles						
R See section on marking						

(1) Solely on the top stage. (2) Comb type jumper bar from 2 to 22 poles, see accessories.



## Transistor output optocoupler plugs

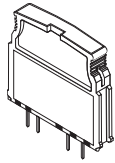

### 100 mA output optocoupler 5 V DC

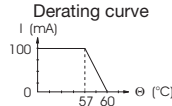
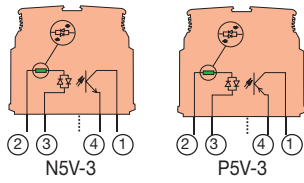

### 100 mA output optocoupler 24 V DC

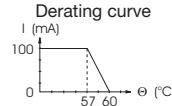
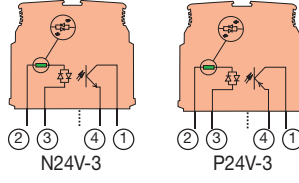

### 100 mA output optocoupler 48 V DC

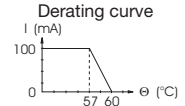
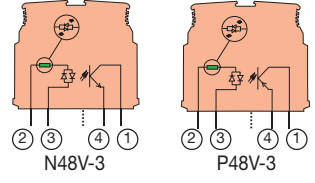

Part numbers	Type	P/N	Type	P/N	Type	P/N
	<b>BNMS N5V-3</b>	1SNA031806R1300	<b>BNMS N24V-3</b>	1SNA031807R1400	<b>BNMS N48V-3</b>	1SNA031808R2500
	<b>BNMS P5V-3</b>	1SNA031809R2600	<b>BNMS P24V-3</b>	1SNA031810R1200	<b>BNMS P48V-3</b>	1SNA031811R0700
<b>Characteristics</b>						
<b>INPUT</b>						
Voltage	4,5 V to 5,5 V DC		20,4 V to 28,8 V DC		40,8 V to 57,6 V DC	
Max. current	8,5 mA		4,8 mA		3,9 mA	
Typical triggering threshold at $I_s = 100\%$	2,9 V DC		16 V DC		26 V DC	
Switching time C/O	20 $\mu$ s / 1,3 ms		20 $\mu$ s / 1,3 ms		20 $\mu$ s / 1,3 ms	
Leakage current	1 mA		1 mA		1 mA	
<b>OUTPUT</b>						
Max. voltage / Max. current	58 V / 100 mA		58 V / 100 mA		58 V / 100 mA	
Residual voltage max. I and rated U						
standard U	1 V DC		1 V DC		1 V DC	
max.	1,3 V DC		1,3 V DC		1,3 V DC	
Frequency on inductive load	See Note 1		See Note 1		See Note 1	
Input / Output isolation	2,5 kV		2,5 kV		2,5 kV	
<b>TEMPERATURE</b>						
Storage	- 30°C to + 80°C		- 30°C to + 80°C		- 30°C to + 80°C	
Operating	- 20°C to + 60°C		- 20°C to + 60°C		- 20°C to + 60°C	

5

## MOS output optocoupler plugs

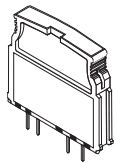

### 1 A output optocoupler 5 V DC

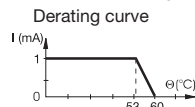
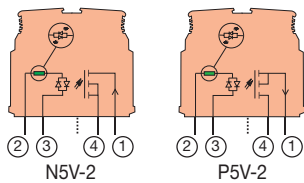

### 1 A output optocoupler 24 V DC

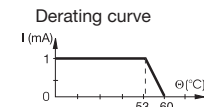
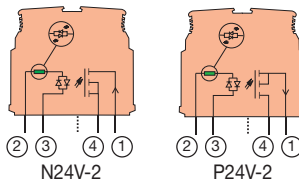

#### Note 1 :

$$F_{max} = (1 - 0,007 \times U_s) / (L \times I_s^2)$$

or

$$F_{max} = (1 - 0,007 \times U_s) / (P \times \frac{L}{R})$$

$U_s$  = Output voltage supply  
 $I_s$  = Output current  
 $L$  = Inductive load  
 $P$  = Load power  
 $R$  = Load resistance

Part numbers	Type	P/N	Type	P/N
	<b>BNMS N5V-2</b>	1SNA031816R0400	<b>BNMS N24V-2</b>	1SNA031817R0500
	<b>BNMS P5V-2</b>	1SNA031818R1600	<b>BNMS P24V-2</b>	1SNA031819R1700
<b>Characteristics</b>				
<b>INPUT</b>				
Voltage	4,5 V to 5,5 V DC		20,4 V to 28,8 V DC	
Max. current	12,5 mA		6,7 mA	
Typical triggering threshold at $I_s=100\%$	3,5 V DC		10 V DC	
Switching time C/O	20 $\mu$ s / 250 $\mu$ s		50 $\mu$ s / 350 $\mu$ s	
Leakage current	1 mA		1 mA	
<b>OUTPUT</b>				
Max. voltage / Max. current	58 V / See graphs		58 V / See graphs	
Residual voltage max. I and rated U				
standard U	1 V DC		1 V DC	
max.	1,3 V DC		1,3 V DC	
Frequency on inductive load	See Note 1		See Note 1	
Input / Output isolation	2,5 kV		2,5 kV	
<b>TEMPERATURE</b>				
Storage	- 30°C to + 80°C		- 30°C to + 80°C	
Operating	- 20°C to + 60°C		- 20°C to + 60°C	

## MOS output optocoupler plug

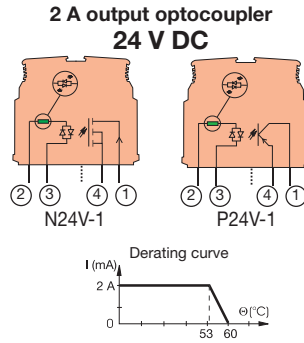
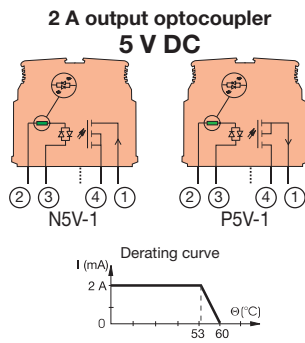
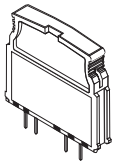

### Note 2 :

$$F_{max} = (1 - 0,012 \times U_s) / (L \times I_s^2)$$

or

$$F_{max} = (1 - 0,012 \times U_s) / (P \times \frac{1}{R})$$

U<sub>s</sub> = Output voltage supply  
I<sub>s</sub> = Output current  
L = Inductive load  
P = Load power  
R = Load resistance

Part numbers	Type	P/N	Type	P/N
	<b>BNMS N5V-1</b>	1SNA031812R0000	<b>BNMS N24V-1</b>	1SNA031813R0100
	<b>BNMS P5V-1</b>	1SNA031814R0200	<b>BNMS P24V-1</b>	1SNA031815R0300
<b>Characteristics</b>				
<b>INPUT</b>				
Voltage	4,5 V to 5,5 V DC		20,4 V to 28,8 V DC	
Max. current	12,5 mA		6,7 mA	
Typical triggering threshold	3,5 V DC		10 V DC	
Switching time C/O	20 μs / 250 μs		50 μs / 350 μs	
Leakage current	1 mA		1 mA	
<b>OUTPUT</b>				
Max. voltage / Max. current	30 V DC / See graphs		30 V / See graphs	
Residual voltage max. I and rated U				
standard U	1 V DC		1 V DC	
max.	1,3 V DC		1,3 V DC	
Frequency on inductive load	See Note 2		See Note 2	
Input / Output isolation	2,5 kV		2,5 kV	
<b>TEMPERATURE</b>				
Storage	- 30°C to + 80°C		- 30°C to + 80°C	
Operating	- 20°C to + 60°C		- 20°C to + 60°C	

## Triac output optocoupler plug

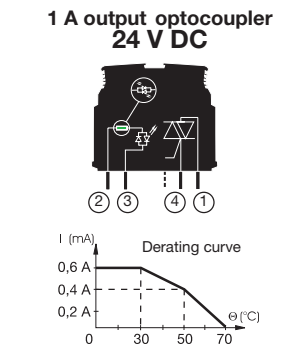
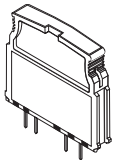

Part numbers	Type	P/N
	<b>BNMS A24V-4</b>	1SNA031839R1300
<b>Characteristics</b>		
<b>INPUT</b>		
Voltage	20,4 V to 28,8 V DC	
Max. current	3,8 mA	
Typical triggering threshold	10 V DC	
Switching time C/O	9,5 ms / 12 ms	
Leakage current		
<b>OUTPUT</b>		
Max. voltage / Max. current	24 V to 253 V AC / See derating curve	
Residual voltage max. I and rated U		
standard U	1 V AC	
max.	1,3 V AC	
Input / Output isolation	2,5 kV	
<b>TEMPERATURE</b>		
Storage	- 30°C to + 80°C	
Operating	- 20°C to + 70°C	

## Relay plugs

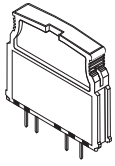

### 1 SPDT relay

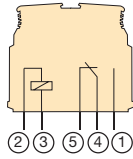

R24V-1

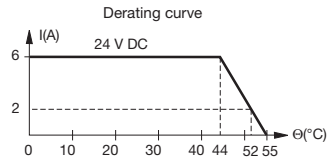

Part numbers	Type	P/N
	<b>BNMS R24V-1</b>	1SNA031820R1400
	<b>BNMS R24V-2</b>	1SNA031847R1300

Characteristics	BNMS R24V-1	BNMS R24V-2
<b>COIL</b>		
Voltage	20,4 V to 28,8 V DC	
Current max.	7 mA	
Trip voltage	1,2 V	
<b>CONTACT</b>		
Type	1 SPDT	
Voltage mini. / max.	12 V / 250 V	5 V / 250 V
Switching current mini. / max.	10 mA / 6 A	1 mA / 6 A
Switching current AC1 mini. / max.	0,6 VA/1500 VA (resistance)	0,05 VA/1500 VA (resistance)
Switching current DC1 mini. / max.	0,6 W / 140 W	0,05 W / 140 W
Number of operations on load	10 <sup>6</sup> operations for AC15	
Number of operations off load	10x10 <sup>6</sup> operations	
Operating speed C/O	6 ms / 8 ms	
Bounce	1,5 ms	
Isolation Coil / Contact	4 kV	
Resistance to shock waves Coil / Contact	4 kV	
Isolation Contact / Contact	1 kV	
<b>TEMPERATURE</b>		
Storage	- 40°C to + 80°C	
Operating	- 20°C to + 55°C	

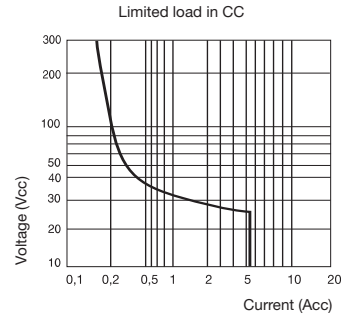

	DC12	AC12	DC13	AC15
24 V	6 A	6 A	1 A	3 A
110/120 V	0,3 A	6 A	0,2 A	3 A
220/230 V	0,2 A	6 A	0,1 A	3 A

5

## Analogical plugs

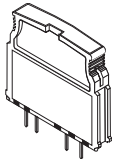

### Current / Voltage Converter

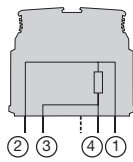

Plug with 250 Ω accuracy resistance for analogical signals.

### Current / Voltage Converter

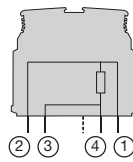

Plug with 500 Ω accuracy resistance for analogical signals.

Part numbers	Type	P/N	Type	P/N
	<b>BNMS CA I/U-250</b>	1SNA031832R0400	<b>BNMS CA I/U-500</b>	1SNA031833R0500

  

Characteristics	250 Ω	500 Ω
Resistance	250 Ω	500 Ω
Power	0,35 W	0,35 W
Accuracy	0,1 %	0,1 %
Stability	25 ppm	25 ppm

## Fuse and strap plugs

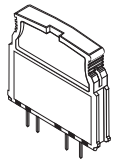

### Output fuse plug

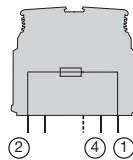

### Input fuse plug

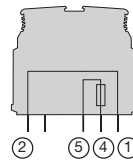

### Strap plug

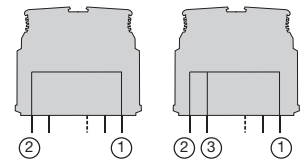

Part numbers	Type	P/N	Type	P/N	Type	P/N
	<b>BNMS F125mA-1</b>	125 V / 125 mA	1SNA031821R0100	<b>BNMS F125mA-3</b>	125 V / 125 mA	1SNA031827R0700
	<b>BNMS F500mA-1</b>	125 V / 500 mA	1SNA031838R1200	<b>BNMS F125mA-4</b>	250 V / 125 mA	1SNA031828R1000
	<b>BNMS F2A-1</b>	125 V / 2 A	1SNA031822R0200			
	<b>BNMS F5A-1</b>	125 V / 5 A	1SNA031823R0300			
	<b>BNMS F125mA-2</b>	250 V / 125 mA	1SNA031824R0400			
	<b>BNMS F2A-2</b>	250 V / 2 A	1SNA031825R0500			
	<b>BNMS F5A-2</b>	250 V / 5 A	1SNA031826R0600			
					<b>BNMS ST1</b>	1SNA031829R1100
					<b>BNMS ST2</b>	1SNA031830R1600



BADL



BAM2

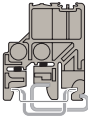

BAMH



BADH



PR30

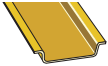

PR3.Z2

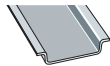

PR3.G2



PR5



PR4



FC2

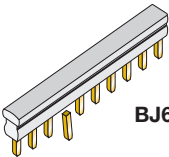

BJ612-...

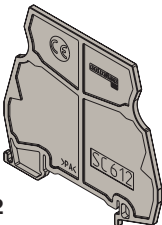

SC612

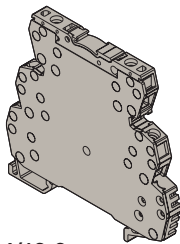

D4/12-3...

## End stops

The end stops are mounted at the extremity of the terminal board assembly, giving additional support to the terminal blocks as markers. For various types of marking, refer to the marker section.

Description	Type	Order P/N	Packaging Weight kg
End stop DIN 3			
grey V0	BADL 9 mm	1SNA399903R0200	50
End stop with screws DIN 3			
grey V0	BAM2 V0 10 mm	1SNA399967R0100	50
grey V2	BAM2 10 mm	1SNA206351R1600	50
beige V0	BAM2 V0 10 mm	1SNA296351R0000	50
High end stop with screws DIN 1 and DIN 3			
grey	BAMH 9,1 mm	1SNA114836R0000	50
beige V0	BAMH V0 9,1 mm	1SNA194836R0100	50
High end stop with screws DIN 3			
grey	BADH 12 mm	1SNA116900R2700	50

## Mounting rails

Symmetrical zinc bichromate plated steel prepunched rail	PR30 2 m	1SNA173220R0500	1
Symmetrical zinc bichromate plated steel rail	PR3.Z2 2 m	1SNA174300R1700	1
White, symmetrical passivated galvanized steel rail	PR3.G2 2 m	1SNA164800R0300	1
Symmetrical zinc bichromate plated steel rail	PR5 2 m	1SNA168700R2200	1
Symmetrical zinc bichromate plated steel rail	PR4 2 m	1SNA168500R1200	1

## Test devices

Test plug DIA. 2 mm	FC2	1SNA007865R2600	10
---------------------	-----	-----------------	----

## Assembled jumper bar

This accessory permits electrical connection between 2 to 70 blocks with 6 mm spacing placed side by side. It can be used with screw clamp or spring clamp blocks with 6 mm or 12 mm spacing. Interconnection of blocks not placed side by side is possible if teeth of the jumper bar have been cut in front of the blocks not to be connected. These teeth can be removed using pliers. Use of separator end sections before and after the jumper bar is required to preserve IP20 protection of the assembly.

Assembled jumper bar 10 poles - 24 A	BJ612-10	1SNA290488R0100	10
Assembled jumper bar 70 poles - 24 A	BJ612-70	1SNA290489R0200	10

## Separator end section

Directly mounted on the rail beside the block, it permits to identify and make electrical insulation of product groups using jumper bars. Dimensions are the same as screw clamp blocks : width 70 mm and height on rail 67,5 mm with 2 mm spacing.

Separator end section	SC612	1SNA290474R0200	10
-----------------------	-------	-----------------	----

## Distribution module

This terminal block with BJ612-... jumper bars permits 2 polarities distribution (*PCL side and process side*) thanks to two separate circuits, each of them including :

- one 4 mm<sup>2</sup> input,
- two 2,5 mm<sup>2</sup> outputs
- one double output for jumper bar BJ612-...

It permits also the connection of ground to the rail though a 4 mm<sup>2</sup> input.

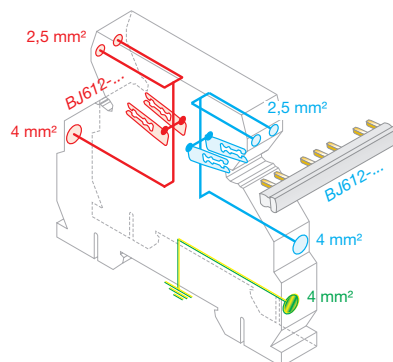

Rated voltage : 250 VAC-DC  
 Rated current : 32 A (4 mm<sup>2</sup>) - 16 A (2,5 mm<sup>2</sup>)  
 Recommended torque : 0,4 - 0,6 Nm

Screw clamp distribution block sp. 12 mm	D4/12-3-3	1SNA645031R2000	5
Spring clamp distribution block sp. 12 mm	D4/12-3R-3R	1SNA645531R2200	5



## Accessories

### PCMS

#### Comb-type jumper

This accessory permits the electrical connection of 2 to 22 blocks.

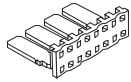

No. of poles	Grey UL94V0	Red UL94V0	Blue UL94V0	Green/Yellow UL94V0
2	1SNA205491R2300	1SNA205492R2400	1SNA205493R2500	1SNA205494R2600
3	1SNA205495R2700	1SNA205496R2800	1SNA205497R2900	1SNA205498R3000
4	1SNA205499R3100	1SNA205500R3200	1SNA205501R3300	1SNA205502R3400
5	1SNA205503R3500	1SNA205504R3600	1SNA205505R3700	1SNA205506R3800
6	1SNA205507R3900	1SNA205508R4000	1SNA205509R4100	1SNA205510R4200
7	1SNA205511R4300	1SNA205512R4400	1SNA205513R4500	1SNA205514R4600
8	1SNA205515R4700	1SNA205516R4800	1SNA205517R4900	1SNA205518R5000
9	1SNA205519R5100	1SNA205520R5200	1SNA205521R5300	1SNA205522R5400
10	1SNA205523R5500	1SNA205524R5600	1SNA205525R5700	1SNA205526R5800
11	1SNA205527R5900	1SNA205528R6000	1SNA205529R6100	1SNA205530R6200
12	1SNA205531R6300	1SNA205532R6400	1SNA205533R6500	1SNA205534R6600
13	1SNA205535R6700	1SNA205536R6800	1SNA205537R6900	1SNA205538R7000
14	1SNA205539R7100	1SNA205540R7200	1SNA205541R7300	1SNA205542R7400
15	1SNA205543R7500	1SNA205544R7600	1SNA205545R7700	1SNA205546R7800
16	1SNA205547R7900	1SNA205548R8000	1SNA205549R8100	1SNA205550R8200
17	1SNA205551R8300	1SNA205552R8400	1SNA205553R8500	1SNA205554R8600
18	1SNA205555R8700	1SNA205556R8800	1SNA205557R8900	1SNA205558R9000
19	1SNA205559R9100	1SNA205560R9200	1SNA205561R9300	1SNA205562R9400
20	1SNA205563R9500	1SNA205564R9600	1SNA205565R9700	1SNA205566R9800
21	1SNA205567R9900	1SNA205568R0000	1SNA205569R0100	1SNA205570R0200
22	1SNA205571R0300	1SNA205572R0400	1SNA205573R0500	1SNA205574R0600

5

### PEF

#### Identification label holders

Designed to hold RPEV label (see opposite).

PEF \* 1SNA020568R0400

\* Delivered with labels.

The label holders are removable and the labels can be changed easily.

• For mounting on PCB in a 3,7 mm diameter hole.

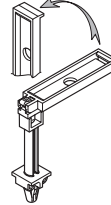

• For mounting on a PCB block in a 2 mm diameter hole (no support leg).

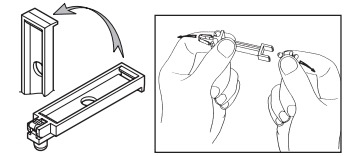

### RPEV

#### Label for PEF 29 x 6 mm

Sheets of 99 pre-cut labels



✓ Blank RPEV 1SNA173178R0700

## DC

#### Test device on screw head

This patented device is mounted on the round screwdriver opening. It is used for trouble shooting, measuring and control for monitoring and repairing an installation, on blocks without a test socket. For this, the device receives an FC2 test plug.

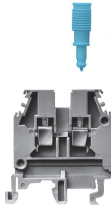

The DC's are differentiated by their colour :

blue for MA 2,5/5 blocks

DCB 1SNA105028R2100

## PC

#### Comb-type jumper bar

PC EIP

This accessory can be used only on the terminal blocks with at least one compression clamp connection. It permits the electrical connection of 2 to 10 blocks.

Interconnection of non-consecutive blocks is possible by removing the teeth opposite the blocks which must not be connected. The comb-type jumper bars can be cut using pliers (or a saw) : in this case, the use of an insulating tip EIP is recommended. The comb is placed in the compression clamp before tightening the screws, above the eventual conductor.

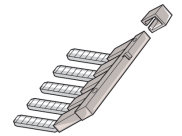
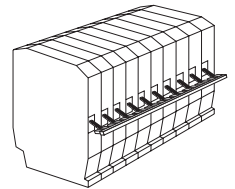

To be mounted on blocks series R900 and R910 :

Insulating tip for comb EIP 1SNA113550R2000  
Comb-type jumper bar PC9 15 A 10 poles 1SNA210160R1200

## BJ Jumper bar

BJS Jumper bar not assembled

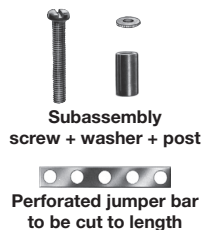

To connect terminal blocks, place the metal tube into the top center hole on each terminal block to be connected.

The metal tube contacts the terminal block's internal connector bar.

The perforated bar is cut to length and placed flat along the center opening of the series of terminal blocks.

The screw is inserted into the perforated bar's hole which is located directly above the blocks being connected. The screw goes through the threaded metal tube and is screwed into the terminal block's internal connector bar. This completes the electrical connection to the perforated bar and connects the block.

To be mounted on blocks series R910 :

Screw + washer + post EV6D 1SNA168400R1600  
Perforated jumper bar BJS9 32 A 8 poles 1SNA177583R1200  
BJS9 32 A 16 poles 1SNA177584R1300

## RL Lengthwise marker

RLV Lengthwise marker  
Width 9 mm .354"

Large area for writing.  
To be snapped onto the top of blocks.

Blank marker for writing : RLV 1SNA103849R0300



## IDC jumper

### (insulation displacement jumper)

#### Characteristics

Wire size mm <sup>2</sup> / AWG	IEC		CSA
	NFC	VDE	
Rigid	2,5 mm <sup>2</sup>	14 AWG	
Flexible	2,5 mm <sup>2</sup>	14 AWG	
Voltage	600	600	
Current	26	15	
Rated wire size	mm <sup>2</sup> / AWG	2,5 mm <sup>2</sup> 14 AWG	
Working temperature	°C	-55°C -> +110°C	
Protection	IP20 / NEMA1		

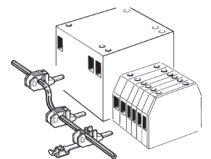
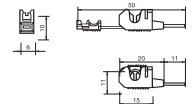

Quick-jump lets you interconnect screw clamp terminals of different sizes, levels and all manufacturers quickly and safely. Its insulation displacement technology makes it easy to use, fast, economical and does not require a special tool. Use as a jumper between relays, switches and other electronic components. ABB Quick-jump will fit any screw clamp type terminal block, from 6 mm .238" spacing and larger.

#### How to use : connecting Quick-jump to your terminal

- 1 - Insert ABB Quick-jump into your terminal screw clamp.
- 2 - Tighten the terminal screw.
- 3 - Guide jumper wire through the V-shaped opening in the Quick-jump.
- 4 - Secure the wire by closing the Quick-jump lever with any flat nose pliers.

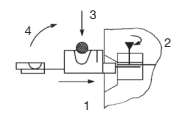

#### Adding a shunt in an installation :

- 1 - Insert ABB Quick-jump into your terminal screw clamp.
- 2 - Guide the terminal screw clamp into contact with the wire.
- 3 - Secure the wire by closing the Quick-jump lever with any flat nose pliers.
- 4 - Tighten the terminal screw.

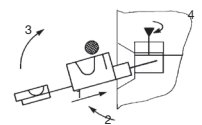

Insulation displacement jumper AD 2,5 1SNA114205R2000



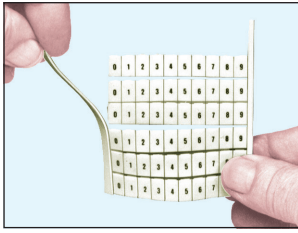

1

Remove one of the side bands of the card.

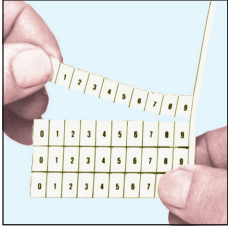

2

Separate the chosen strip from the rest of the card.

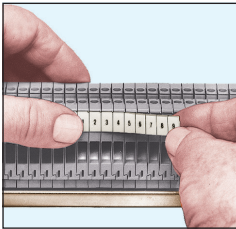

3

Press the first marker in place, hold it and slide your thumb on the rest of the strip.

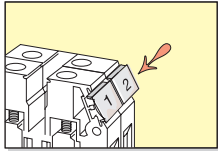

Horizontal marking

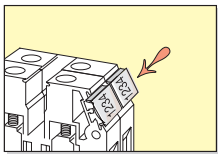

Vertical marking



Refilable box of 100 cards of 18 RC markers

## Marking for Interface Modules

Selection table

Markers for modules :	RC610	RC55	RC65
R500	⊘	●	⊘
R600	●	POSSIBLE	●
R900	⊘	●	⊘
R910	●	POSSIBLE	●
R1800	⊘	●	⊘

Possible mounting : **POSSIBLE**

Recommended mounting : ●

Impossible mounting : ⊘

## Marking for terminal blocks

Standard RC marker cards

Marker sizes	<div style="display: flex; justify-content: space-around; font-size: small;"> <span>(x) = Nb of cards in 5 mm spacing kit</span> <span>(x) = Nb of cards in 6 mm spacing kit</span> <span>(x) = Nb of cards in 6 mm spacing kit</span> </div>		
	RC55	RC65	RC610
Blank cards	1SNA230000R1200	1SNA232000R0000	1SNA233000R0100
<b>Horizontal marking</b>			
10 strips from 1 to 10	1SNA230002R0000 (5)	1SNA232002R2600 (5)	1SNA233002R2700 (25)
10 strips from 11 to 20	1SNA230003R0100 (2)	1SNA232003R2700 (2)	1SNA233003R2000 (10)
10 strips from 21 to 30	1SNA230004R0200	1SNA232004R2000	1SNA233004R2100 (6)
10 strips from 31 to 40	1SNA230005R0300	1SNA232005R2100	1SNA233005R2200 (4)
10 strips from 41 to 50	1SNA230006R0400	1SNA232006R2200	1SNA233006R2300 (3)
10 strips from 51 to 60	1SNA230007R0500	1SNA232007R2300	1SNA233007R2400 (2)
10 strips from 61 to 70	1SNA230008R1600	1SNA232008R0400	1SNA233008R0500 (2)
From 1 to 100	1SNA230030R0700 (2)	1SNA232030R2500 (2)	1SNA233030R2600 (15)
From 101 to 200	1SNA230031R2400	1SNA232031R1200	1SNA233031R1300 (2)
20 times L1-L2-L3-N-PE	1SNA230131R2500	1SNA232131R1300	1SNA233131R1400 (2)
<b>Vertical marking</b>			
10 strips from 1 to 10	1SNA230041R0600	1SNA232041R2400	1SNA233041R2500 (5)
10 strips from 11 to 20	1SNA230042R0700	1SNA232042R2500	1SNA233042R2600 (3)
10 strips from 21 to 30	1SNA230043R0000	1SNA232043R2600	1SNA233043R2700 (2)
10 strips from 31 to 40	1SNA230044R0100	1SNA232044R2700	1SNA233044R2000 (2)
From 1 to 100	1SNA230060R1500	1SNA232060R0300	1SNA233060R0400 (8)

## Marking kit RC 5 mm spacing or 6 mm spacing

Box with 100 cards with 18 various part numbers (see table next page)

Description	Type	Order P/N	Packaging Weight kg
Box with 100 cards RC 5 mm spacing		1SNA400085R2700	1
Refill for box RC 5 mm		1SNA400145R0700	1
Box with 100 cards RC 6 mm spacing		1SNA400084R2600	1
Refill for box RC 6 mm		1SNA400144R0600	1