

Photovoltaic Series

Planar Diffused Silicon Photodiodes

The Photovoltaic Detector series is utilized for applications requiring high sensitivity and moderate response speeds, with an additional sensitivity in the visible-blue region for the blue enhanced series. The spectral response ranges from 350 to 1100 nm, making the regular photovoltaic devices ideal for visible and near IR applications. For additional sensitivity in the 350 nm to 550 nm region, the blue enhanced devices are more suitable.

These detectors have high shunt resistance and low noise, and exhibit long term stability. Unbiased operation of these detectors offers stability under wide temperature variations in DC or low speed applications. For high light levels (greater than 10mW/cm²), the Photoconductive Series detectors should be considered for better linearity.

These detectors are not designed to be reverse biased! Very slight improvement in response time may be obtained with a slight bias. Applying a reverse bias of more than a few volts (>3V) will permanently damage the detectors. If faster response times are required, the Photoconductive Series should be considered.

Refer to the Photovoltaic Mode (PV) paragraph in the "Photodiode Characteristics" section of this catalog for detailed information on electronics set up.



APPLICATIONS

- Colorimeters
- Photometers
- Spectroscopy Equipment
- Fluorescence

FEATURES

- Ultra Low Noise
- High Shunt Resistance
- Wide Dynamic Range
- Blue Enhanced

Typical Shunt Resistance vs. Temperature

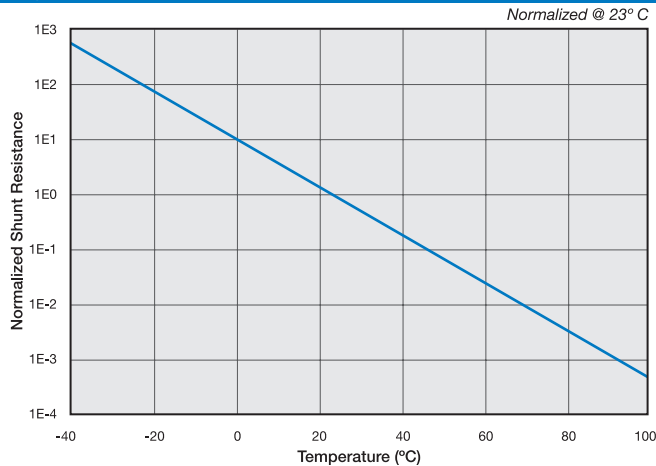

Typical Spectral Response

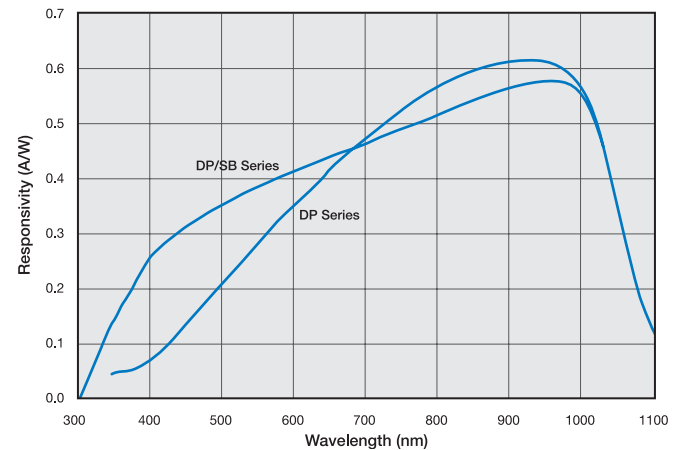

Photovoltaic Series

Typical Electro-Optical Specifications at T_A=23°C

Model Number	Active Area		Peak Responsivity Wavelength	Responsivity at λ _p		Capacitance (pF)	Shunt Resistance (GΩ)		NEP (W/√Hz)	Rise Time (ns)	Temp.* Range (°C)		Package Style ¶
	Area (mm ²)	Dimensions (mm)	λ _p (nm)	(A/W)		0 V	-10 mV		0V 970 nm	0 V 632 nm 50 Ω	Operating	Storage	
			typ.	min.	typ.	max.	min.	typ.	typ.	typ.			

'DP' Series, Metal Package

CD-1705	0.88	0.93 sq	850	970	0.55	0.60	70	1.0	10	2.1 e-15	2000	-40 ~ +100	-55 ~ +125	71 / Plastic
PIN-2DPI ‡	1.1	0.81 x 1.37	150				30				4 / TO-18			
PIN-125DPL	1.6	1.27 sq.	160				8 / TO-18							
PIN-3CDPI	3.2	1.27 x 2.54	320				0.5	5.0	3.0 e-15	50	4 / TO-18			
PIN-3CDP											7 / TO-18			
PIN-5DPI	5.1	2.54 φ	500				0.4	4.0	3.4 e-15	60	2 / TO-5			
PIN-5DP											5 / TO-5			
PIN-13DPI	13	3.6 sq	1200				0.35	3.5	3.6 e-15	150	2 / TO-5			
PIN-13DP											5 / TO-5			
PIN-6DPI	16.4	4.57 φ	2000				0.2	2.0	3.9 e-15	220	3 / TO-8			
PIN-6DP											6 / TO-8			
PIN-44DPI	44	6.6 sq	4300				0.1	1.0	4.8 e-15	475	3 / TO-8			
PIN-44DP											6 / TO-8			
PIN-10DPI	100	11.28 φ	9800				0.05	0.2	6.8 e-15	1000	10 / Lo-Prof			
PIN-10DP											11 / BNC			
PIN-25DP	613	27.9 φ	60000	0.002	0.1	3.0 e-14	6600	-10 ~ +60	-20 ~ +70	12 / BNC				

'DP' Series, Plastic Package §

PIN-220DP	200	10 x 20	970	0.55	0.60	20000	0.02	0.2	1.2 e-14	2200	-10 ~ +60	-20 ~ +70	27 / Plastic
-----------	-----	---------	-----	------	------	-------	------	-----	----------	------	-----------	-----------	--------------

Super Blue Enhanced 'DP/SB' Series, (All Specifications @ λ = 410 nm. V_{BIAS} = 0V, R_L = 50Ω)

Model No.	Active Area/Dimensions		Responsivity (A/W)		Capacitance (pF)	R _{sh} (MΩ)	NEP (W/√Hz)	Operating Current (mA)	Rise Time (μs)	Operating	Storage	Package Style ¶
	mm ²	mm	min.	typ.	typ.	min.	typ.	max.	typ.			
PIN-040DP/SB	0.81	1.02 φ	0.15	0.20	60	600	2.0 e-14	0.5	0.02	-10 ~ +60	-20 ~ +70	1 / TO-18
PIN-5DP/SB †	5.1	2.54 φ			450	150	5.2 e-14	2.0	0.2			5 / TO-5
PIN-10DP/SB	100	11.28 φ			8800	10	2.0 e-13	10.0	2.0			11 / BNC
PIN-10DPI/SB					10 / Metal							
PIN-220DP/SB	200	10 x 20			17000	5	2.9 e-13	10.0	4.0			27 / Plastic

'5T' Series, Blue

Model No.	Active Area/Dimensions		Responsivity (A/W) 436nm		Capacitance (pF) 0V	R _{sh} (MΩ)	NEP (W/√Hz)	Dark Current (pA)	Rise Time (μs)	Operating	Storage	Package Style ¶
	mm ²	mm	min.	typ.	max	min.	typ.	max.	typ.			
OSD1-5T	1.0	1.0 sq	0.18	0.21	35	250	2.5 e-14	1.0	7	-25 ~ +75	-45 ~ +100	7 / TO-18
OSD3-5T	3.0	2.5 x 1.2			80	100	3.0 e-14	2.0	9			7 / TO-18
OSD5-5T	5.0	2.5 φ			130	100	3.3 e-14	2.0	9			5 / TO-5
OSD15-5T	15.0	3.8 sq			390	50	5.6 e-14	10.0	12			5 / TO-5
OSD60-5T	62.0	7.9 sq			1800	3	2.1 e-13	25.0	30			72 / TO-8
OSD100-5TA	100.0	11.3 φ			2500	2	2.5 e-13	30.0	45			74 / Special

‡ The 'I' suffix on the model number is indicative of the photodiode chip being isolated from the package by an additional pin connected to the case.

§ The photodiode chips in "FIL" series are isolated in a low profile plastic package. They have a large field of view as well as "in line" pins.

¶ For mechanical drawings please refer to pages 58 thru 69.

† Operating Temperature: -40 to +100 °C, Storage Temperature: -55 to +125 °C.

* Non-Condensing temperature and Storage Range, Non-Condensing Environment.

1. Parameter Definitions:

A = Distance from top of chip to top of glass.

a = Photodiode Anode.

B = Distance from top of glass to bottom of case.

c = Photodiode Cathode

(Note: cathode is common to case in metal package products unless otherwise noted).

W = Window Diameter.

F.O.V. = Field of View (see definition below).

2. Dimensions are in inches (1 inch = 25.4 mm).

3. Pin diameters are 0.018 ± 0.002" unless otherwise specified.

4. Tolerances (unless otherwise noted)

General: 0.XX ±0.01"

0.XXX ±0.005"

Chip Centering: ±0.010"

Dimension 'A': ±0.015"

5. Windows

All '**UV**' Enhanced products are provided with QUARTZ glass windows, 0.027 ± 0.002" thick.

All '**XUV**' products are provided with removable windows.

All '**DLS**' PSD products are provided with A/R coated glass windows.

All '**FIL**' photoconductive and photovoltaic products are epoxy filled instead of glass windows.

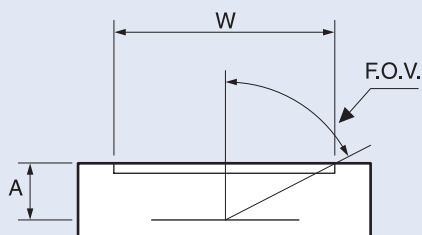

$$F.O.V. = \tan^{-1} \left(\frac{W}{2A} \right)$$



For Further Assistance
Please Call One of Our Experienced
Sales and Applications Engineers

310-978-0516



- Or -
On the Internet at

www.osioptoelectronics.com

Mechanical Specifications

All units in inches. Pinouts are bottom view.

1 TO-18	2 TO-5	3 TO-8																																		
<p>Products:</p> <p>PIN-020A PIN-040A PIN-040-DP/SB</p> <p>Pin Circle Dia.=0.100</p> <table border="1"> <thead> <tr> <th>P/N</th> <th>A</th> <th>B</th> <th>W</th> </tr> </thead> <tbody> <tr> <td>PIN-020A</td> <td>0.075</td> <td>0.200</td> <td>0.155</td> </tr> <tr> <td>PIN-040A</td> <td>0.075</td> <td>0.200</td> <td>0.155</td> </tr> </tbody> </table>	P/N	A	B	W	PIN-020A	0.075	0.200	0.155	PIN-040A	0.075	0.200	0.155	<p>Products:</p> <p>PIN-5DI PIN-5DPI PIN-13DI PIN-13DPI PIN-5-YAG CD-25T</p> <p>Pin Circle Dia.=0.200</p> <table border="1"> <thead> <tr> <th>P/N</th> <th>A</th> <th>B</th> <th>W</th> </tr> </thead> <tbody> <tr> <td>All Others</td> <td>0.094</td> <td>0.180</td> <td>0.240</td> </tr> <tr> <td>CD-25T</td> <td>0.050</td> <td>0.130</td> <td>0.23</td> </tr> </tbody> </table>	P/N	A	B	W	All Others	0.094	0.180	0.240	CD-25T	0.050	0.130	0.23	<p>Products:</p> <p>PIN-6DI PIN-6DPI PIN-44DI PIN-44DPI OSD35-0 OSD35-7Q</p> <p>Pin Circle Dia.=0.295</p> <table border="1"> <thead> <tr> <th>P/N</th> <th>A</th> </tr> </thead> <tbody> <tr> <td>PIN-6DI/6DPI</td> <td>0.115</td> </tr> <tr> <td>PIN-44DI/44DPI</td> <td>0.125</td> </tr> <tr> <td>OSD35-0</td> <td>0.130</td> </tr> <tr> <td>OSD35-7Q</td> <td>0.130 Quartz Window</td> </tr> </tbody> </table>	P/N	A	PIN-6DI/6DPI	0.115	PIN-44DI/44DPI	0.125	OSD35-0	0.130	OSD35-7Q	0.130 Quartz Window
P/N	A	B	W																																	
PIN-020A	0.075	0.200	0.155																																	
PIN-040A	0.075	0.200	0.155																																	
P/N	A	B	W																																	
All Others	0.094	0.180	0.240																																	
CD-25T	0.050	0.130	0.23																																	
P/N	A																																			
PIN-6DI/6DPI	0.115																																			
PIN-44DI/44DPI	0.125																																			
OSD35-0	0.130																																			
OSD35-7Q	0.130 Quartz Window																																			
<p>Products:</p> <p>PIN-2DI PIN-2DPI PIN-3CDP PIN-3CDPI BPX-65R</p> <p>Pin Circle Dia.=0.100</p> <table border="1"> <thead> <tr> <th>P/N</th> <th>A</th> <th>B</th> </tr> </thead> <tbody> <tr> <td>BPX-65R</td> <td>0.070</td> <td>0.200</td> </tr> <tr> <td>All Others</td> <td>0.090</td> <td>0.150</td> </tr> </tbody> </table>	P/N	A	B	BPX-65R	0.070	0.200	All Others	0.090	0.150	<p>Products:</p> <p>PIN-5D PIN-5DP PIN-5DP/SB PIN-13D PIN-13DP PIN-005E-550F UV-001 UV-005 UV-005D UV-005E UV-013D UV-013E UV-015 OSD-5-0 OSD15-0 OSD5-5T OSD15-5T OSD5.8-7Q OSD5.8-7U</p> <p>Pin Circle Dia.=0.200</p> <table border="1"> <thead> <tr> <th>P/N</th> <th>A</th> <th>B</th> </tr> </thead> <tbody> <tr> <td>OSD-Prefix Devices</td> <td>0.050</td> <td>0.130</td> </tr> <tr> <td>All Others</td> <td>0.102</td> <td>0.180</td> </tr> </tbody> </table> <p>Quartz Window: OSD5.8-7Q UV Transmissive Window: OSD5.8-7U</p>	P/N	A	B	OSD-Prefix Devices	0.050	0.130	All Others	0.102	0.180	<p>Products:</p> <p>PIN-6D PIN-6DP PIN-44D PIN-44DP UV-020 UV-035D UV-035E UV-035</p> <p>Pin Circle Dia.=0.295</p>																
P/N	A	B																																		
BPX-65R	0.070	0.200																																		
All Others	0.090	0.150																																		
P/N	A	B																																		
OSD-Prefix Devices	0.050	0.130																																		
All Others	0.102	0.180																																		
<p>Products:</p> <p>PIN-3CD PIN-3CDP BPX-65 OSD1-0 OSD1-5T OSD3-5T OSD1.2-7Q OSD1.2-7U</p> <p>Pin Circle Dia.=0.100</p> <table border="1"> <thead> <tr> <th>P/N</th> <th>A</th> <th>B</th> </tr> </thead> <tbody> <tr> <td>PIN-3CD / 3CDP</td> <td>0.087</td> <td>0.146</td> </tr> <tr> <td>BPX-65</td> <td>0.075</td> <td>0.200</td> </tr> <tr> <td>OSD-Prefix Devices</td> <td>0.080</td> <td>0.200</td> </tr> </tbody> </table> <p>Quartz Window: OSD1.2-7Q UV Transmissive Window: OSD1.2-7U</p>	P/N	A	B	PIN-3CD / 3CDP	0.087	0.146	BPX-65	0.075	0.200	OSD-Prefix Devices	0.080	0.200	<p>Products:</p> <p>PIN-125DPL</p> <p>Pin Circle Dia.=0.100</p>	<p>Products:</p> <p>PIN-HR005 PIN-HR008 PIN-HR020 PIN-HR026 PIN-HR040</p> <p>Pin Circle Dia.=0.100</p>																						
P/N	A	B																																		
PIN-3CD / 3CDP	0.087	0.146																																		
BPX-65	0.075	0.200																																		
OSD-Prefix Devices	0.080	0.200																																		

All units in inches. Pinouts are bottom view.

Low Profile

Products:
 PIN-10DI
 PIN-10DPI
 PIN-10DPI/SB
 UV-50L
 UV-100L

Pin Circle Dia.=0.73

BNC

Products:
 PIN-10D
 PIN-10DP
 PIN-10DP/SB
 UV-50
 UV-100

Outer Contact — Anode	PIN-10D, PIN-10DP, PIN-10DP/SB
Outer Contact — Cathode	UV-50, UV-100

BNC

Products:
 PIN-25D
 PIN-25DP

Outer Contact — Anode

Special BNC

Products:
 PIN-10AP
 PIN-10DF

P/N	A	B	C
PIN-10DF	0.217	0.330	1.020
PIN-10AP	0.386	0.550	1.415

Special Plastic

Products:
 FIL-5C
 FIL-20C
 FIL-UV20
 FIL-C4DG

P/N	A	B
FIL-5C FIL-20C	0.060	0.130
FIL-UV005 FIL-UV20 FIL-C4DG	0.087	0.152

P/N	1	2	3	4	5	6
FIL-5C FIL-20C FIL-UV005	a	-	c	a	-	c
FIL-UV20	c	-	a	c	-	a
FIL-C4DG	c	a	c	c	a	c

Special Plastic

Products:
 FIL-44C
 FIL-100C
 FIL-UV50
 FIL-UV100
 FIL-C10DG

P/N	A	B
FIL-44C FIL-100C	0.052	0.130
FIL-UV50 FIL-UV100 FIL-C10DG	0.090	0.155

P/N	1	2	3	4	5	6	7	8
FIL-44C FIL-100C	a	-	-	c	a	-	-	c
FIL-UV50 FIL-UV100	c	-	-	a	c	-	-	a
FIL-C10DG	c	a	a	c	c	a	a	c

All units in inches. Pinouts are bottom view.

22 TO-5

Products:

XUV-005

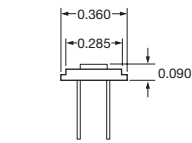

Pin Circle Dia.=0.200



23 TO-8

Products:

XUV-020
XUV-035

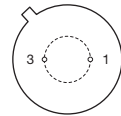
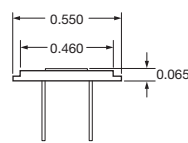

Pin Circle Dia.=0.295

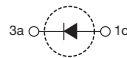

24 TO-8

Products:

PIN-DSIn-TEC

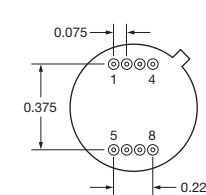
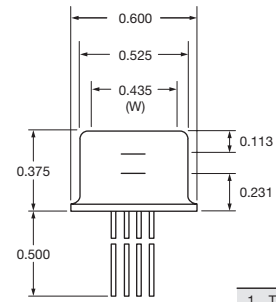

Pinout

- 1 TEC (-)
- 2 Thermistor
- 3 Thermistor
- 4 TEC (+)
- 5 Bottom InGaAs, Cathode
- 6 Bottom InGaAs, Anode
- 7 Top Silicon, Anode
- 8 Top Silicon, Cathode

25 Special Ceramic / Plastic

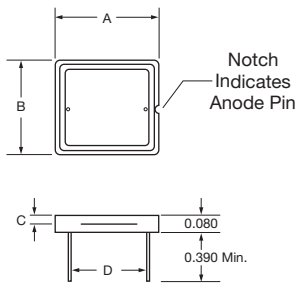

Notch Indicates Anode Pin

Dimensions

P/N	A	B	C	D
UV-005EC	0.400	0.350	0.030	0.280
UV-035EC	0.400	0.350	0.030	0.290
UV-100EC	0.650	0.590	0.048	0.500
UV-005DC	0.400	0.350	0.030	0.280
UV-035DC	0.400	0.350	0.030	0.290
UV-100DC	0.650	0.590	0.053	0.500
XUV-50C	0.650	0.590	0.027	0.490
XUV-100C	0.650	0.590	0.027	0.490
RD-100	0.650	0.590	0.027	0.490
RD-100A	0.650	0.590	0.027	0.490
UV-35P	0.390	0.345	0.050	0.275
OSD35-7CO	0.390	0.350	---	0.290
OSD35-LR-A	0.390	0.350	---	0.290
OSD35-LR-D	0.390	0.350	---	0.290

Note: OSD35-prefix packages come with 0.31" (min.) leads

26 TO-8

Products:

RD-100
RD-100A
UV-35P
UV-005EC
UV-035EC
UV-100EC
UV-005DC
UV-035DC
UV-100DC
XUV-50C
XUV-100C
OSD35-7CO
OSD35-LR-A
OSD35-LR-D

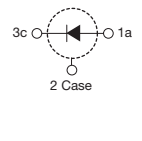
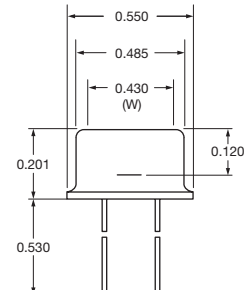

Pin Circle Dia.=0.295

27 Special Plastic

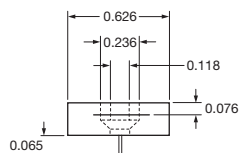
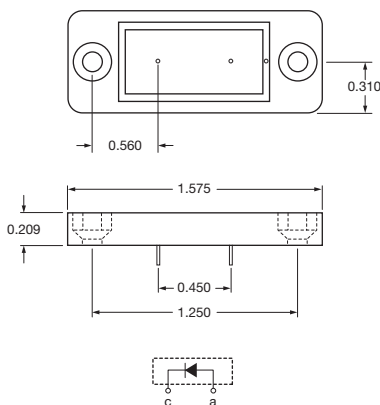

Pin Diameter=0.040



28 BNC

Products:

PIN-220D
PIN-220DP
PIN-220DP/SB

Products:

XUV-100

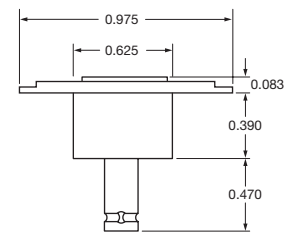

BNC Connector
Outer Contact = Cathode

Mechanical Specifications

All units in inches. Pinouts are bottom view.

68 TO-18	69 TO-18	70 TO-5
<p>Products: APD-300 APD-500</p> <p>Pin Circle Dia.=0.100</p>	<p>Products: APD-300L APD-500L</p> <p>Pin Circle Dia.=0.100</p>	<p>Products: APD-900 APD-1500 APD-3000</p> <p>Pin Circle Dia.=0.200</p>
71 Plastic	72 TO-8	73 TO-8
<p>Products: CD-1705</p> <p>ANODE CATHODE</p>	<p>Products: OSD-60-0</p> <p>CATHODE & CASE ANODE</p>	<p>Products: QD50-0</p> <p>CATHODE & CASE Q4 Q3 Q2 Q1 QUADRANT ANODE 1</p>
74 Special	75 TO-5	76 Plastic Molded
<p>Products: OSD100-0A OSD100-5TA</p> <p>RED DOT INDICATES CATHODE LEAD</p>	<p>Products: DLS-2S</p> <p>Pin Circle Dia.= 0.200 Bottom View</p>	<p>Products: OS-P200</p> <p>OPTICAL C 0.020 0.100</p>