



**MICROCHIP**

---

**HV9805**  
**120V<sub>AC</sub> Off-Line LED Driver**  
**Evaluation Board**  
**User's Guide**

---

**Note the following details of the code protection feature on Microchip devices:**

- Microchip products meet the specification contained in their particular Microchip Data Sheet.
- Microchip believes that its family of products is one of the most secure families of its kind on the market today, when used in the intended manner and under normal conditions.
- There are dishonest and possibly illegal methods used to breach the code protection feature. All of these methods, to our knowledge, require using the Microchip products in a manner outside the operating specifications contained in Microchip's Data Sheets. Most likely, the person doing so is engaged in theft of intellectual property.
- Microchip is willing to work with the customer who is concerned about the integrity of their code.
- Neither Microchip nor any other semiconductor manufacturer can guarantee the security of their code. Code protection does not mean that we are guaranteeing the product as "unbreakable."

Code protection is constantly evolving. We at Microchip are committed to continuously improving the code protection features of our products. Attempts to break Microchip's code protection feature may be a violation of the Digital Millennium Copyright Act. If such acts allow unauthorized access to your software or other copyrighted work, you may have a right to sue for relief under that Act.

---

Information contained in this publication regarding device applications and the like is provided only for your convenience and may be superseded by updates. It is your responsibility to ensure that your application meets with your specifications. MICROCHIP MAKES NO REPRESENTATIONS OR WARRANTIES OF ANY KIND WHETHER EXPRESS OR IMPLIED, WRITTEN OR ORAL, STATUTORY OR OTHERWISE, RELATED TO THE INFORMATION, INCLUDING BUT NOT LIMITED TO ITS CONDITION, QUALITY, PERFORMANCE, MERCHANTABILITY OR FITNESS FOR PURPOSE. Microchip disclaims all liability arising from this information and its use. Use of Microchip devices in life support and/or safety applications is entirely at the buyer's risk, and the buyer agrees to defend, indemnify and hold harmless Microchip from any and all damages, claims, suits, or expenses resulting from such use. No licenses are conveyed, implicitly or otherwise, under any Microchip intellectual property rights.

**Trademarks**

The Microchip name and logo, the Microchip logo, dsPIC, FlashFlex, flexPWR, JukeBlox, KEELOQ, KEELOQ logo, Kleer, LANCheck, MediaLB, MOST, MOST logo, MPLAB, OptoLyzer, PIC, PICSTART, PIC<sup>32</sup> logo, RightTouch, SpyNIC, SST, SST Logo, SuperFlash and UNI/O are registered trademarks of Microchip Technology Incorporated in the U.S.A. and other countries.

The Embedded Control Solutions Company and mTouch are registered trademarks of Microchip Technology Incorporated in the U.S.A.

Analog-for-the-Digital Age, BodyCom, chipKIT, chipKIT logo, CodeGuard, dsPICDEM, dsPICDEM.net, ECAN, In-Circuit Serial Programming, ICSP, Inter-Chip Connectivity, KleerNet, KleerNet logo, MiWi, MPASM, MPF, MPLAB Certified logo, MPLIB, MPLINK, MultiTRAK, NetDetach, Omniscient Code Generation, PICDEM, PICDEM.net, PICkit, PICtail, RightTouch logo, REAL ICE, SQI, Serial Quad I/O, Total Endurance, TSHARC, USBCheck, VariSense, ViewSpan, WiperLock, Wireless DNA, and ZENA are trademarks of Microchip Technology Incorporated in the U.S.A. and other countries.

SQTP is a service mark of Microchip Technology Incorporated in the U.S.A.

Silicon Storage Technology is a registered trademark of Microchip Technology Inc. in other countries.

GestIC is a registered trademarks of Microchip Technology Germany II GmbH & Co. KG, a subsidiary of Microchip Technology Inc., in other countries.

All other trademarks mentioned herein are property of their respective companies.

© 2015, Microchip Technology Incorporated, Printed in the U.S.A., All Rights Reserved.

ISBN: 978-1-63277-149-0

**QUALITY MANAGEMENT SYSTEM  
CERTIFIED BY DNV  
= ISO/TS 16949 =**

*Microchip received ISO/TS-16949:2009 certification for its worldwide headquarters, design and wafer fabrication facilities in Chandler and Tempe, Arizona; Gresham, Oregon and design centers in California and India. The Company's quality system processes and procedures are for its PIC<sup>®</sup> MCUs and dsPIC<sup>®</sup> DSCs, KEELOQ<sup>®</sup> code hopping devices, Serial EEPROMs, microperipherals, nonvolatile memory and analog products. In addition, Microchip's quality system for the design and manufacture of development systems is ISO 9001:2000 certified.*

**Object of Declaration: HV9805 120V<sub>AC</sub> Off-Line LED Driver Evaluation Board**

**EU Declaration of Conformity**

**Manufacturer:** Microchip Technology Inc.  
2355 W. Chandler Blvd.  
Chandler, Arizona, 85224-6199  
USA

This declaration of conformity is issued by the manufacturer.

The development/evaluation tool is designed to be used for research and development in a laboratory environment. This development/evaluation tool is not a Finished Appliance, nor is it intended for incorporation into Finished Appliances that are made commercially available as single functional units to end users under EU EMC Directive 2004/108/EC and as supported by the European Commission's Guide for the EMC Directive 2004/108/EC (8<sup>th</sup> February 2010).

This development/evaluation tool complies with EU RoHS2 Directive 2011/65/EU.

This development/evaluation tool, when incorporating wireless and radio-telecom functionality, is in compliance with the essential requirement and other relevant provisions of the R&TTE Directive 1999/5/EC and the FCC rules as stated in the declaration of conformity provided in the module datasheet and the module product page available at [www.microchip.com](http://www.microchip.com).

For information regarding the exclusive, limited warranties applicable to Microchip products, please see Microchip's standard terms and conditions of sale, which are printed on our sales documentation and available at [www.microchip.com](http://www.microchip.com).

Signed for and on behalf of Microchip Technology Inc. at Chandler, Arizona, USA

  
Derek Carlson  
VP Development Tools

12-Sep-14  
Date

NOTES:



# HV9805 120V<sub>AC</sub> OFF-LINE LED DRIVER EVALUATION BOARD USER'S GUIDE

## Table of Contents

<b>Preface</b> .....	<b>7</b>
Introduction .....	7
Document Layout .....	7
Conventions Used in this Guide .....	8
Recommended Reading .....	9
The Microchip Web Site .....	9
Customer Support .....	9
Revision History .....	9
<b>Chapter 1. Product Overview</b>	
1.1 Introduction .....	11
1.2 HV9805 Device Short Overview .....	11
1.2.1 HV9805 Device Key Features .....	12
1.2.2 Two-Stage Topology: .....	13
1.3 What Does the HV9805 120V <sub>AC</sub> Off-Line LED Driver Evaluation Board Do? .....	13
1.4 What is Included in the HV9805 120V <sub>AC</sub> Off-Line LED Driver Evaluation Board Kit? .....	14
<b>Chapter 2. Installation and Operation</b>	
2.1 Introduction .....	15
2.1.1 Board Features .....	15
2.2 Getting Started .....	16
2.2.1 Powering the Evaluation Board .....	16
2.3 How does the HV9805 120V <sub>AC</sub> Off-Line LED Driver Evaluation Board Work? .....	17
2.4 Board Testing, Test Points Waveforms and Overall Measured Parameters .....	19
2.4.1 Board Testing .....	19
2.4.2 Test Points Waveforms .....	19
2.4.3 Overall Measured Parameters .....	24
<b>Appendix A. Schematic and Layouts</b>	
A.1 Introduction .....	27
A.2 Board – Schematic .....	28
A.3 Board – Top Silk .....	29
A.4 Board – Top Copper .....	29
A.5 Board – Bottom Copper .....	30
<b>Appendix B. Bill of Materials (BOM)</b>	
<b>Worldwide Sales and Service</b> .....	<b>34</b>

NOTES:

---

---

## Preface

---

---

### NOTICE TO CUSTOMERS

All documentation becomes dated, and this manual is no exception. Microchip tools and documentation are constantly evolving to meet customer needs, so some actual dialogs and/or tool descriptions may differ from those in this document. Please refer to our web site ([www.microchip.com](http://www.microchip.com)) to obtain the latest documentation available.

Documents are identified with a “DS” number. This number is located on the bottom of each page, in front of the page number. The numbering convention for the DS number is “DSXXXXXXXXA”, where “XXXXXXXX” is the document number and “A” is the revision level of the document.

For the most up-to-date information on development tools, see the MPLAB® IDE online help. Select the Help menu, and then Topics to open a list of available online help files.

## INTRODUCTION

This chapter contains general information that will be useful to know before using the HV9805 120V<sub>AC</sub> Off-Line LED Driver Evaluation Board. Items discussed in this chapter include:

- [Document Layout](#)
- [Conventions Used in this Guide](#)
- [Recommended Reading](#)
- [The Microchip Web Site](#)
- [Customer Support](#)
- [Revision History](#)

## DOCUMENT LAYOUT

This document describes how to use the HV9805 120V<sub>AC</sub> Off-Line LED Driver Evaluation Board as a development tool for specific applications driven by HV9805. The document is organized as follows:

- **Chapter 1. “Product Overview”** – Important information about the HV9805 120V<sub>AC</sub> Off-Line LED Driver Evaluation Board.
- **Chapter 2. “Installation and Operation”** – Includes instructions on how to get started with the evaluation board, how to operate and test it.
- **Appendix A. “Schematic and Layouts”** – Shows the schematic and layout diagrams for the HV9805 120V<sub>AC</sub> Off-Line LED Driver Evaluation Board.
- **Appendix B. “Bill of Materials (BOM)”** – Lists the parts used to build the HV9805 120V<sub>AC</sub> Off-Line LED Driver Evaluation Board.

# HV9805 120V<sub>AC</sub> Off-Line LED Driver Evaluation Board

## CONVENTIONS USED IN THIS GUIDE

This manual uses the following documentation conventions:

### DOCUMENTATION CONVENTIONS

Description	Represents	Examples
<b>Arial font:</b>		
Italic characters	Referenced books	<i>MPLAB<sup>®</sup> IDE User's Guide</i>
	Emphasized text	...is the <i>only</i> compiler...
Initial caps	A window	the Output window
	A dialog	the Settings dialog
	A menu selection	select Enable Programmer
Quotes	A field name in a window or dialog	"Save project before build"
Underlined, italic text with right angle bracket	A menu path	<u><i>File&gt;Save</i></u>
Bold characters	A dialog button	Click <b>OK</b>
	A tab	Click the <b>Power</b> tab
N'Rnnnn	A number in verilog format, where N is the total number of digits, R is the radix and n is a digit.	4'b0010, 2'hF1
Text in angle brackets < >	A key on the keyboard	Press <Enter>, <F1>
<b>Courier New font:</b>		
Plain Courier New	Sample source code	#define START
	Filenames	autoexec.bat
	File paths	c:\mcc18\h
	Keywords	_asm, _endasm, static
	Command-line options	-Opa+, -Opa-
	Bit values	0, 1
	Constants	0xFF, 'A'
Italic Courier New	A variable argument	<i>file.o</i> , where <i>file</i> can be any valid filename
Square brackets [ ]	Optional arguments	mcc18 [options] <i>file</i> [options]
Curly brackets and pipe character: {   }	Choice of mutually exclusive arguments; an OR selection	errorlevel {0 1}
Ellipses...	Replaces repeated text	var_name [, var_name...]
	Represents code supplied by user	void main (void) { ... }



## RECOMMENDED READING

This user's guide describes how to use HV9805 120V<sub>AC</sub> Off-Line LED Driver Evaluation Board. Another useful document is listed below. The following Microchip document is available and recommended as supplemental reference resources.

HV9805 Data Sheet, *Off-Line LED Driver with True DC Output Current* (DS20005374)

## THE MICROCHIP WEB SITE

Microchip provides online support via our web site at [www.microchip.com](http://www.microchip.com). This web site is used as a means to make files and information easily available to customers. Accessible by using your favorite Internet browser, the web site contains the following information:

- **Product Support** – Data sheets and errata, application notes and sample programs, design resources, user's guides and hardware support documents, latest software releases and archived software
- **General Technical Support** – Frequently Asked Questions (FAQs), technical support requests, online discussion groups, Microchip consultant program member listing
- **Business of Microchip** – Product selector and ordering guides, latest Microchip press releases, listing of seminars and events, listings of Microchip sales offices, distributors and factory representatives

## CUSTOMER SUPPORT

Users of Microchip products can receive assistance through several channels:

- Distributor or Representative
- Local Sales Office
- Field Application Engineer (FAE)
- Technical Support

Customers should contact their distributor, representative or field application engineer (FAE) for support. Local sales offices are also available to help customers. A listing of sales offices and locations is included in the back of this document.

Technical support is available through the web site at:

<http://www.microchip.com/support>.

## REVISION HISTORY

### Revision A (March 2015)

This is the initial release of this document.

# HV9805 120V<sub>AC</sub> Off-Line LED Driver Evaluation Board

NOTES:

---

---

## Chapter 1. Product Overview

---

---

### 1.1 INTRODUCTION

This chapter provides an overview of the HV9805 120V<sub>AC</sub> Off-Line LED Driver Evaluation Board and covers the following topics:

- [HV9805 Device Short Overview](#)
- [What Does the HV9805 120V<sub>AC</sub> Off-Line LED Driver Evaluation Board Do?](#)
- [What is Included in the HV9805 120V<sub>AC</sub> Off-Line LED Driver Evaluation Board Kit?](#)

### 1.2 HV9805 DEVICE SHORT OVERVIEW

The HV9805 driver integrated circuit (IC) is targeted at general light-emitting diode (LED) lighting products, such as LED lamps and LED lighting fixtures with an approximate maximum power rating of 25W at 120V<sub>AC</sub> and 50W at 230V<sub>AC</sub>.

A two-stage topology provides true constant current drive for the LED load while drawing mains power with a high power factor. The first stage, a Boundary Conduction mode boost converter, transfers power from the AC line to a second stage, with a high power factor and high efficiency.

The second stage, a linear regulator arranged for operation with low overhead voltage, transfers power from the first stage to the LED load with true constant current and protects the LED load from overvoltage that may pass from mains to the output of the first stage.

The IC is particularly geared to drive a high-voltage LED load. An LED load arranged as a high-voltage load is capable of offering cost advantages in terms of heat management and optics.

The boost converter employs a cascode switch for high-speed switching and convenient generation of the V<sub>DD</sub> supply. The control device of the cascode switch is integrated into the HV9805 and is rated for a peak current of 0.7A.

The current for powering the V<sub>DD</sub> supply is derived by way of an internal connection to the cascode switch.

Applications that require lower load voltage can be accommodated by adapting the first stage to the SEPIC topology.

## 1.2.1 HV9805 Device Key Features

- Provides true DC light, and protects load from line voltage transients
- Driver topology includes:
  - Boundary Conduction Mode (BCM) Boost Converter with Power Factor Correction
    - a) High Power Factor (0.98 typical)
    - b) High Efficiency (90% typical)
  - Linear Post-Regulator with Low Overhead Voltage
    - a) Zero LED Current/Brightness Ripple
    - b) Overvoltage Protection for LEDs
    - c) High Efficiency
    - d)  $\pm 4\%$  Temperature Reference Accuracy
- Simple V<sub>DD</sub> Supply:
  - No Auxiliary Winding Required
- Boost Converter Cascode Switch:
  - Internal Switch rated at 700 mA peak
  - Supports up to 25W at 120V<sub>AC</sub>
  - Supports up to 50W at 230V<sub>AC</sub>
- Compatibility with SEPIC Topology for Low Output Voltage Applications
- Available Package: 10-Lead MSOP

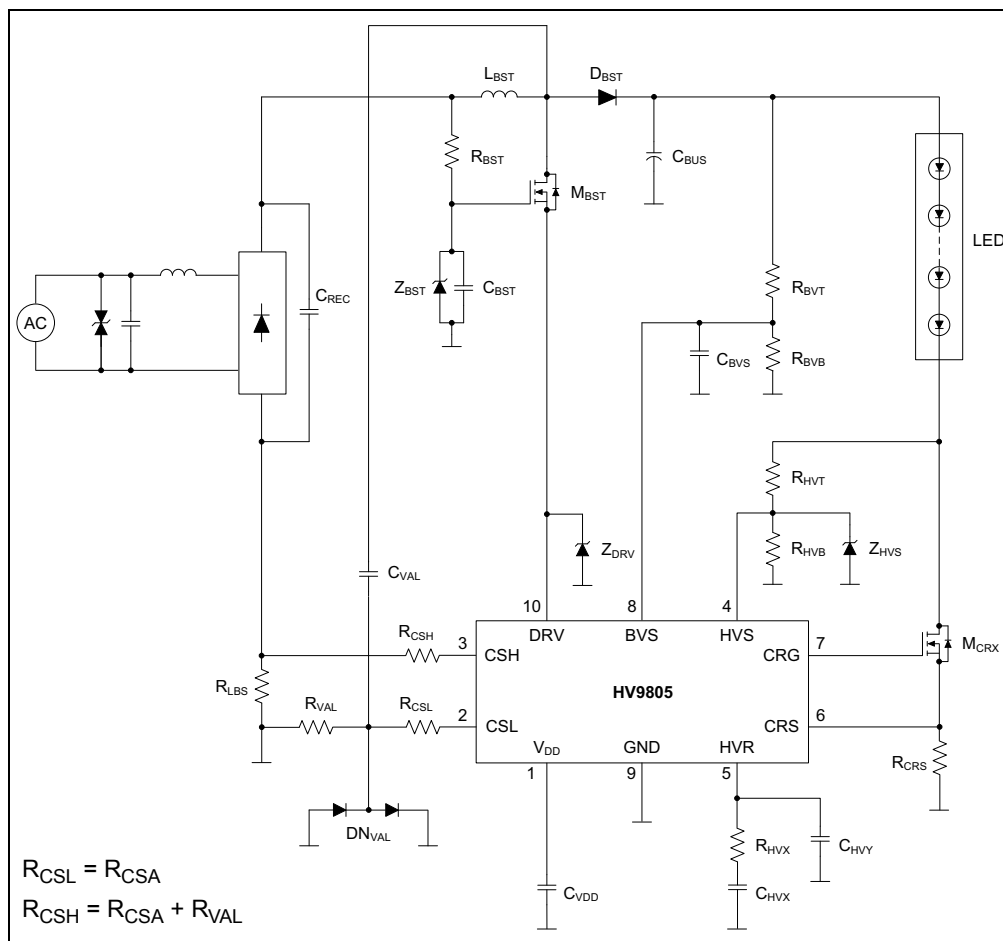

**FIGURE 1-1:** Typical HV9805 Off-Line LED Driver Circuit.

## 1.2.2 Two-Stage Topology:

The two-stage topology of the HV9805 device consists of:

- Boundary Conduction Mode (BCM) and Power Factor Correction (PFC) Boost Converter
- LED Side Linear Regulator

### 1.2.2.1 FIRST STAGE: BCM PFC BOOST CONVERTER

- Produce a DC bus voltage  $V_{BUS}$  with high efficiency, (95%)
- With 100 Hz (120 Hz) ripple and slow regulation (10 Hz BW)
- Direct connection of HV LEDs to the bus results in
  - Relatively large LED current ripple
  - Direct exposure of LEDs to line voltage transients

### 1.2.2.2 SECOND STAGE: LINEAR REGULATOR IN SERIES WITH LED LOAD

- Arranged as a constant current regulator with fast response (>1 kHz)
- LED current is true DC
- LEDs are protected from line overvoltage
- Linear regulator lowers efficiency only 2%
- Continuous Current Regulator (CCR) maintains the headroom voltage  $V_{HDR}$  at a low value (~ 6V)
- Uses the smallest electrolytic capacitors possible (efficiency versus cost trade-off)
- Smooth DC LED current, CCR rejects the larger bus voltage ripple

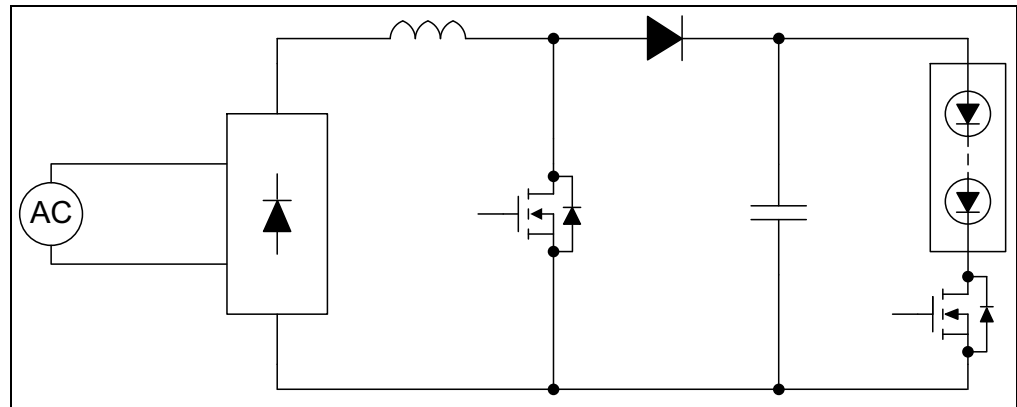

**FIGURE 1-2:** *Principal Diagram, Two-Stage Topology.*

## 1.3 WHAT DOES THE HV9805 120V<sub>AC</sub> OFF-LINE LED DRIVER EVALUATION BOARD DO?

The HV9805 120V<sub>AC</sub> Off-Line LED Driver Evaluation Board is used to evaluate and demonstrate the Microchip HV9805 device in the following topology: a 215V – 265V output Boost Converter application followed by a LED-side linear current regulator, supplied from the mains 120V<sub>AC</sub>, to drive a string of 70 – 90 LEDs .

The HV9805 120V<sub>AC</sub> Off-Line LED Driver Evaluation Board was developed to help engineers reduce the cycle time of product design.

## 1.4 WHAT IS INCLUDED IN THE HV9805 120V<sub>AC</sub> OFF-LINE LED DRIVER EVALUATION BOARD KIT?

The HV9805 120V<sub>AC</sub> Off-Line LED Driver Evaluation Board kit includes:

- HV9805 120V<sub>AC</sub> Off-Line LED Driver Evaluation Board (ADM00651)
- Information Sheet



# HV9805 120V<sub>AC</sub> OFF-LINE LED DRIVER EVALUATION BOARD USER'S GUIDE

---

---

## Chapter 2. Installation and Operation

---

---

### 2.1 INTRODUCTION

The HV9805 control IC provides true current drive for LED lamps and fixtures by way of a simple two-stage power supply topology comprised of a boundary mode (BCM) boost converter and a linear constant current regulator. The constant current regulator removes the influence of bus voltage variation on the LED load operating and current, and protects the LED load from potentially damaging transients that may originate from mains overvoltage events. The IC is targeted at designs operating at a single line voltage, such as 120V<sub>AC</sub> or 230V<sub>AC</sub>, and thus, does not support designs for the universal input voltage range. The efficiency of the constant current regulator is maximized by minimizing the DC component of the headroom voltage.

#### 2.1.1 Board Features

The HV9805 120V<sub>AC</sub> Off-Line LED Driver Evaluation Board has the following features:

- Input Voltage: 120V<sub>AC</sub> ±15%, at 60 Hz Typical
- Output Current: 90 mA ±5%
- Efficiency: over 90%
- Switching Frequency: up to 135 kHz
- Output LED String Voltage: 240V (nom)

## 2.2 GETTING STARTED

The HV9805 120V<sub>AC</sub> Off-Line LED Driver Evaluation Board is fully assembled and tested to evaluate and demonstrate the HV9805 LED driver.

### 2.2.1 Powering the Evaluation Board

The board is connected directly to 120V<sub>AC</sub>. A variable AC power supply is needed for testing and evaluation in the laboratory. The power supply requires an output capability of at least 1A and a voltage range from 0 to 150V<sub>AC</sub>. This can be obtained from an autotransformer supplied from the mains or an electronic AC/AC power supply (for example, the Chroma ATE Inc. 61500 series).

The power connectors are listed here:

- The input connectors, J1 and J2, are placed on the left side of the board and marked 120V<sub>AC</sub> ~, as shown in [Figure 2-1](#).
- The output connectors, J3 and J4, are called LED+ and LED- and are located on the right side of the board.

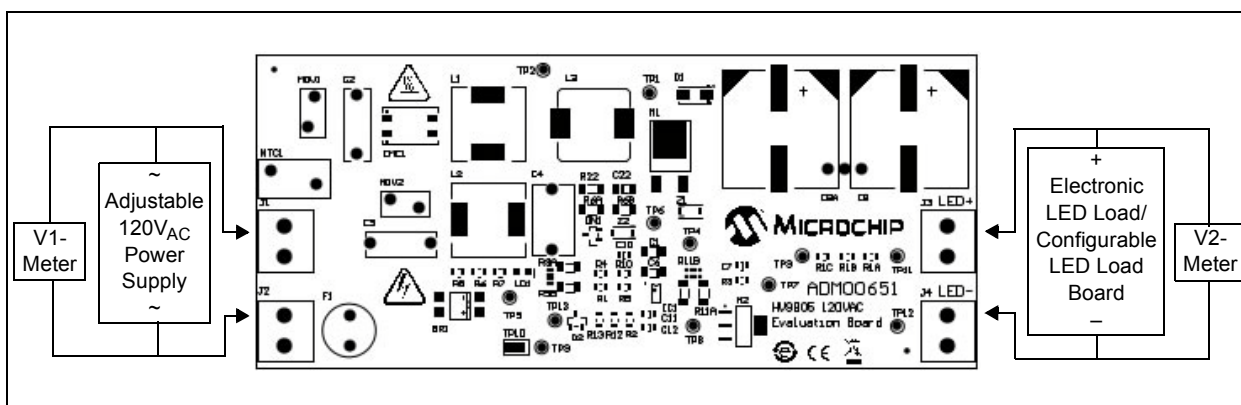

**FIGURE 2-1:** Connection Diagram.

To power the board, follow these steps:

1. Connect the power at J1, 120V<sub>AC</sub>~ and J2, 120V<sub>AC</sub>~ terminals of the board.
2. Connect a voltmeter and the LED string at J3 (LED+) and J4 (LED-) connectors, as shown in [Figure 2-1](#). The LED string can be formed with 70 to 90 LED cells (3 LEDs in parallel), 80 mA SMD LED, 280 mW. An example is shown in [Figure 2-2](#).

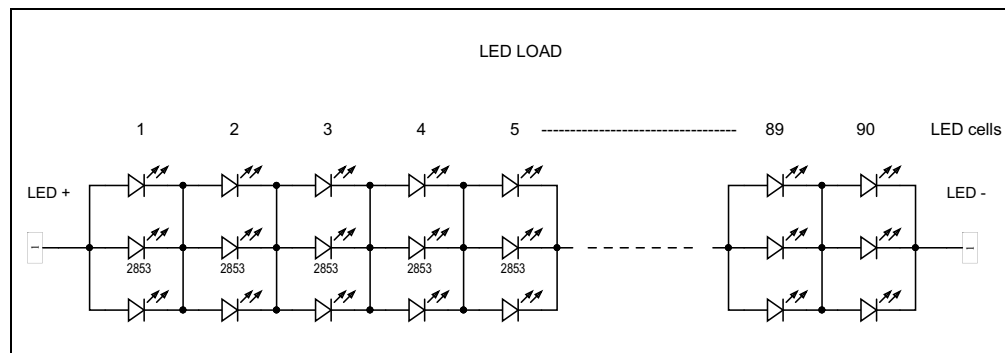

**FIGURE 2-2:** LED Load String Example.



## 2.3 HOW DOES THE HV9805 120V<sub>AC</sub> OFF-LINE LED DRIVER EVALUATION BOARD WORK?

The board was designed to supply by means of a common mode filter, a rectifier, a boost converter followed by a linear regulator, both conducted by the HV9805 driver, directly from the 120V<sub>AC</sub> mains and an LED load with constant current, also controlling the power factor. The topology used in this evaluation board is a Boundary Conduction Mode (BCM) boost converter followed by a linear current regulator on the LED side in order to assure true current and high efficiency.

The HV9805 device has the following regulators:

- The V<sub>DD</sub> regulator, which is inside the chip (only the filter capacitor is outside)
- The LED current regulator
- The headroom voltage regulator
- The line current waveform regulator

The LED current can be programmed using [Equation 2-1](#).

### EQUATION 2-1: SENSE RESISTORS RELATIONSHIP

$$V_{REF, CCR} = I_{LED} \times R_{CRS}$$

Where:

$$\begin{aligned} V_{REF, CCR} &= 1.0V \text{ (at 100\% current level)} \\ I_{LED} &= \text{LED current} \\ R_{CRS} &= \text{Resistor's value is selected by the designer} \end{aligned}$$

### EXAMPLE 2-1:

$$\begin{aligned} \text{If:} \quad I_{LED} &= 90 \text{ mA} \\ \text{Then:} \quad R_{CRS} &= 11.11\Omega \\ \text{Choose:} \quad R_{11A} &= R_{11B} = 22\Omega = 2 \times R_{CRS} \end{aligned}$$

The headroom voltage is programmed to the desired level using [Equation 2-2](#).

### EQUATION 2-2: THE DESIRED DC LEVEL OF HEADROOM VOLTAGE

$$V_{REF, HVR} = V_{HDC} \times K_{DIV}$$

$$K_{DIV} = \frac{R_{HVB}}{R_{HVB} + R_{HVT}}$$

Where:

$$\begin{aligned} V_{REF, HVR} &= 1.25V \\ V_{HDC} &= \text{DC level of the headroom voltage} \\ K_{DIV} &= \text{Attenuation of the headroom voltage divider} \\ R_{HVT}, R_{HVB} &= \text{Top and bottom resistor of the headroom voltage divider} \end{aligned}$$

### EXAMPLE 2-2:

$$\begin{aligned} \text{For:} \quad V_{HDC} &= 4V \\ \text{Then:} \quad K_{DIV} &= 1.25/4 = 0.3125 \\ \text{Therefore:} \quad R_{HVT}/R_{HVB} &= 2.2 \\ \text{Then:} \quad R_{HVB} &= 10 \text{ k}\Omega \\ \text{Choose:} \quad R_{HVT} &= 22 \text{ k}\Omega \end{aligned}$$

The DC level of the bus voltage is regulated to be the total sum of the DC level of the headroom voltage and the operating voltage of the LED load, and will thereby vary during operation with changes in the forward voltage of the LED load.

### EXAMPLE 2-3:

If an 80 LEDs string is used, a forward voltage drop on each LED of 3V is assumed. Then, the Bus Voltage level will be:

$$V_{DC} = 80 \times 3 + V_{HDC} = 240 + 4 = 244V_{DC}$$

**Note:** In order to have a good valley detection, choose an LED string voltage bigger by 20 to 30V than the peak input voltage (which is usually 138V<sub>AC</sub>). In this condition, the minimum LED load voltage is

$$V_{LED\ MIN} = 20 + 1.41 \times 138 = 215V_{DC}$$

The power dissipation of the LED current regulator must be low, so the DC level of the headroom voltage ( $V_{HDC}$ ) will be minimized, the dissipation being calculated using [Equation 2-3](#).

### EQUATION 2-3: THE POWER DISSIPATION OF THE LED CURRENT REGULATOR

$$P_{DIS} = I_{LED} \times V_{HDC}$$

Where:

$P_{DIS}$  = Power dissipation of the current LED regulator

$I_{LED}$  = LED current

$V_{HDC}$  = DC level of the headroom voltage

$$P_{DIS} = 0.090A \times 4V = 0.36W$$

The output voltage of the control amplifier provides the on-time reference for the boost converter control circuitry, according to [Equation 2-4](#).

### EQUATION 2-4: THE ON-TIME REFERENCE FOR THE BOOST CONVERTER CONTROL ( $T_{ON}$ )

$$T_{ON} = K_{HVR} \times V_{HVR}$$

Where:

$T_{ON}$  = On-time reference signal from the headroom voltage regulator

$K_{HVR}$  = Gain of the on-time modulator

$V_{HVR}$  = 5V

$K_{HVR}$  = 2.2  $\mu$ s/V

$$T_{ON} = 5 \times 2.2 \mu s = 11 \mu s$$

## 2.4 BOARD TESTING, TEST POINTS WAVEFORMS AND OVERALL MEASURED PARAMETERS

### 2.4.1 Board Testing

To start testing the evaluation board follow the next steps:

1. Power the board at 120V<sub>AC</sub>.
2. Check that the voltmeter indicates the LED load voltage (do not overcome 270V<sub>DC</sub>).
3. With a power supply of 120V<sub>AC</sub>, verify whether the current regulated through the LED strings is about 90 mA (by means of an ampere-meter connected in series with the LEDs).

The following steps are possible if a variable AC power supply or an autotransformer is available:

4. Set the power supply to 100V<sub>AC</sub> and verify whether the output current on the LED side stays regulated ( $I_{OUT} \sim 90$  mA).
5. Set the power supply to 150V<sub>AC</sub> and verify whether the output current on the LED side stays regulated ( $I_{OUT} \sim 90$  mA). Also, check that the voltage stays regulated on V2, near the value 240V.

### 2.4.2 Test Points Waveforms

The board has several test points that help engineers to analyze the switch node's waveforms of HV9805 device output:

**TABLE 2-1: TEST POINTS**

Test Point	Description
TP1	Boost inductor (L3) voltage
TP2	Rectified line voltage V <sub>DC</sub>
TP3	Bus voltage sense (BVS pin voltage)
TP4 (SW)	The voltage on switching node (DRV pin) of the HV9805 device
TP5	Inductor current sense voltage
TP6	V <sub>DD</sub> voltage on IC (V <sub>DD</sub> pin voltage), (6.5 to 8 V)
TP7	Gate control voltage (CRG pin) of the linear regulator
TP8	The LED current sense (CRS pin)
TP10	GND
TP11 – TP12	LED string voltage
TP13	High-voltage sense (HVS pin voltage)

The regulated headroom voltage is approximately 8V, in order to reduce the losses on the linear regulator.

The signal waveforms from the significant points of the design are presented in Figures 2-3 – 2-11.

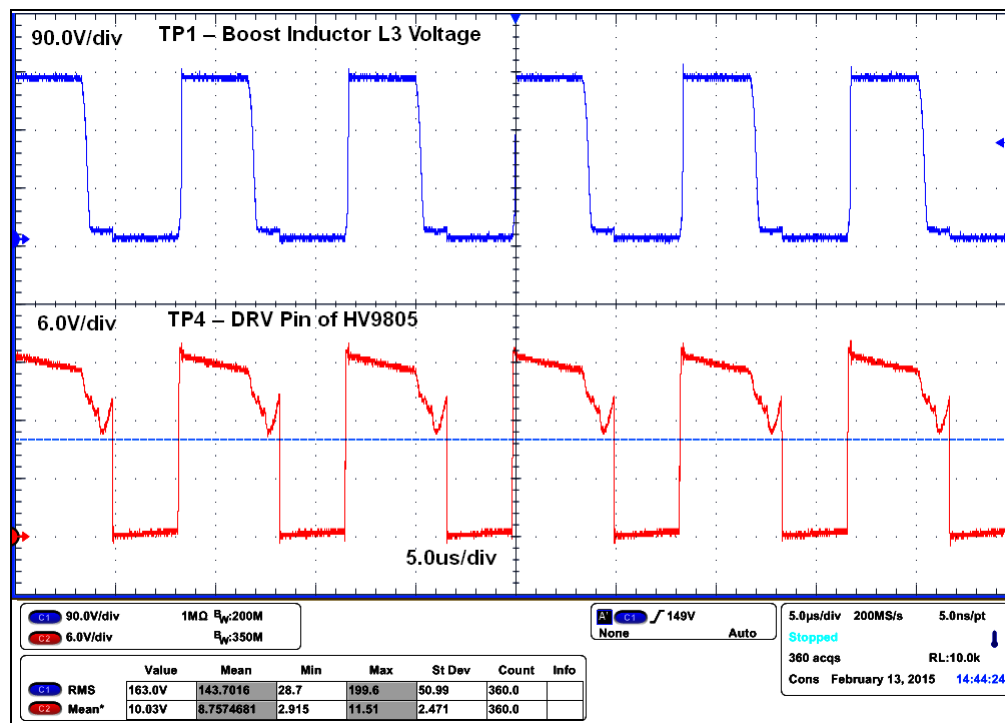

**FIGURE 2-3:** Boost Inductor Voltage (TP1) and DRV Pin Voltage (TP4), Working on the Lower Side of the Sinus Wave Input Voltage.

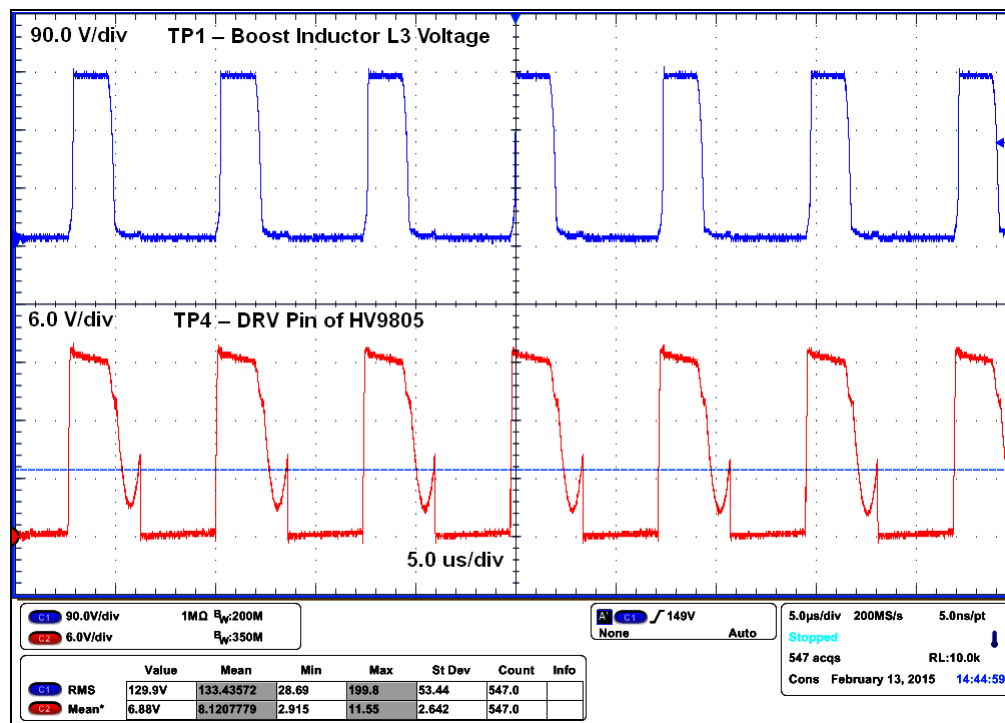

**FIGURE 2-4:** Boost Inductor Voltage (TP1) and DRV Pin Voltage (TP4), Working on the Upper Side of the Sinus Wave Input Voltage.

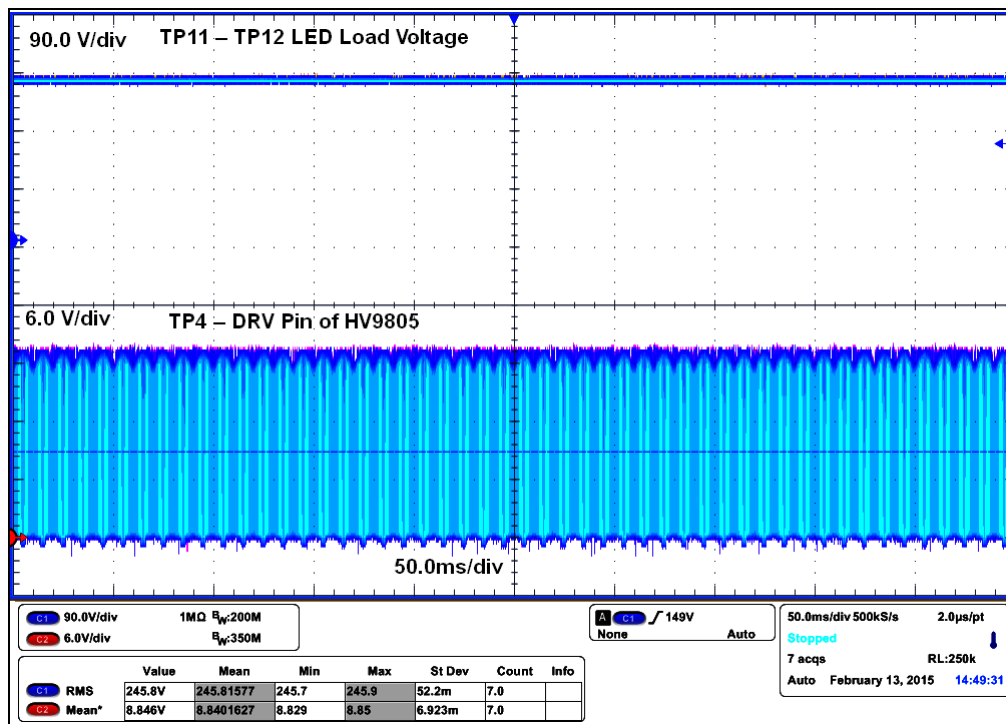

**FIGURE 2-5:** LED Load Voltage (TP12 – TP13) and DRV Pin Voltage (TP4) in Operation Mode.

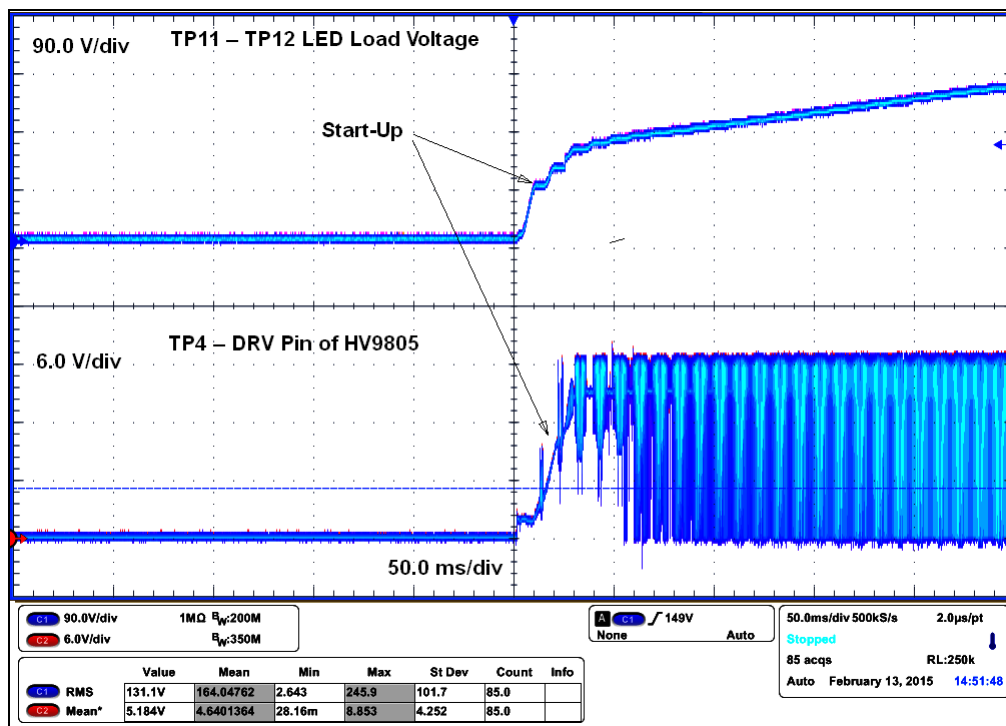

**FIGURE 2-6:** LED Load Voltage (TP12 – TP13) and DRV Pin Voltage (TP4) in Startup Mode.

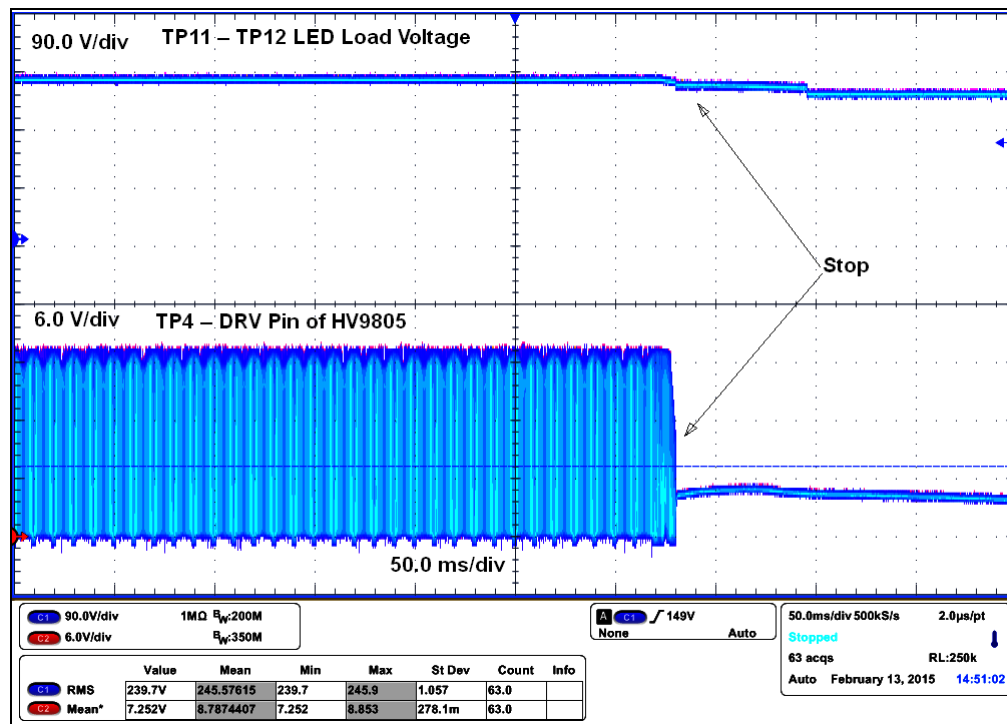

**FIGURE 2-7:** LED Load Voltage (TP12 – TP13) and DRV Pin Voltage (TP4) in Stop Mode.

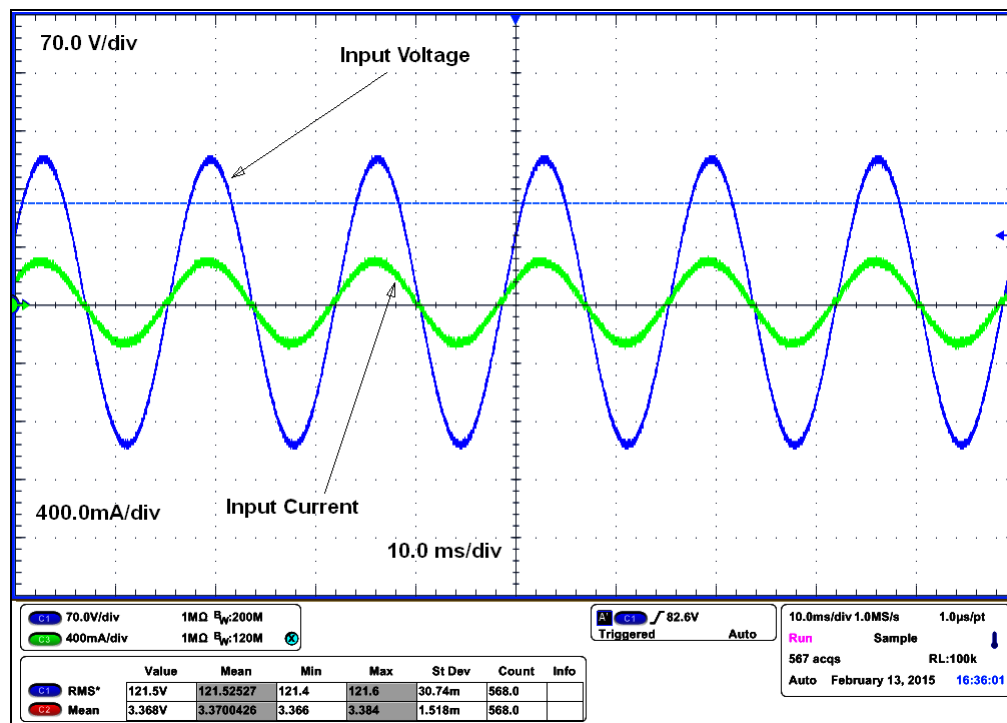

**FIGURE 2-8:** Input Voltage and Input Current, Phase Look.

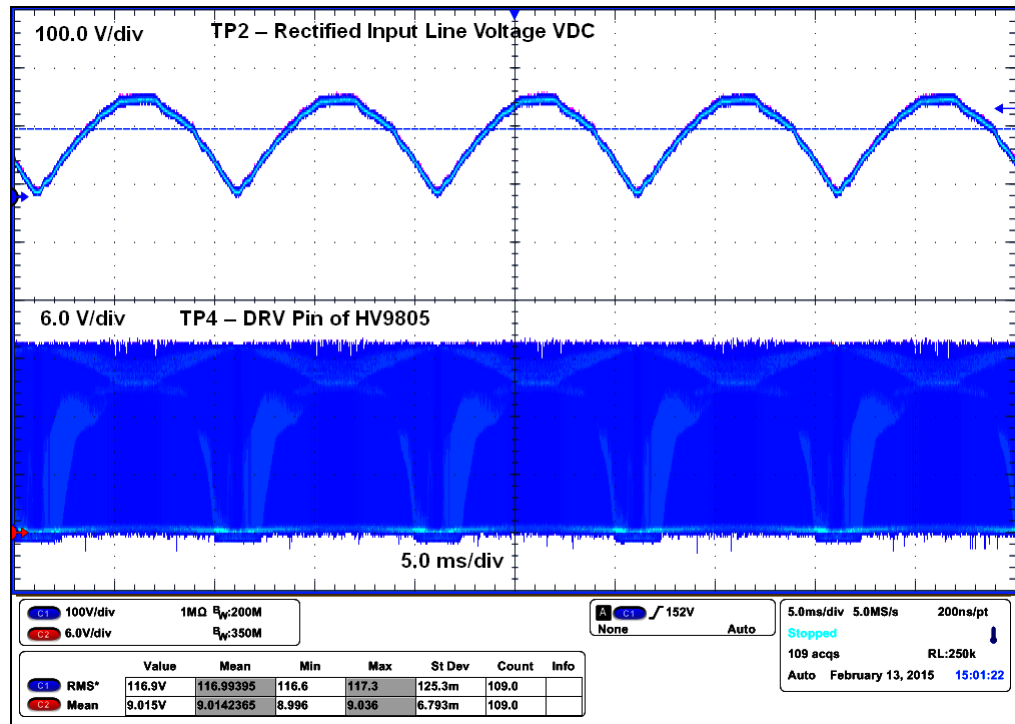

**FIGURE 2-9:** DC Line Voltage (TP2) and DRV Pin Voltage (TP4) in Operation Mode.

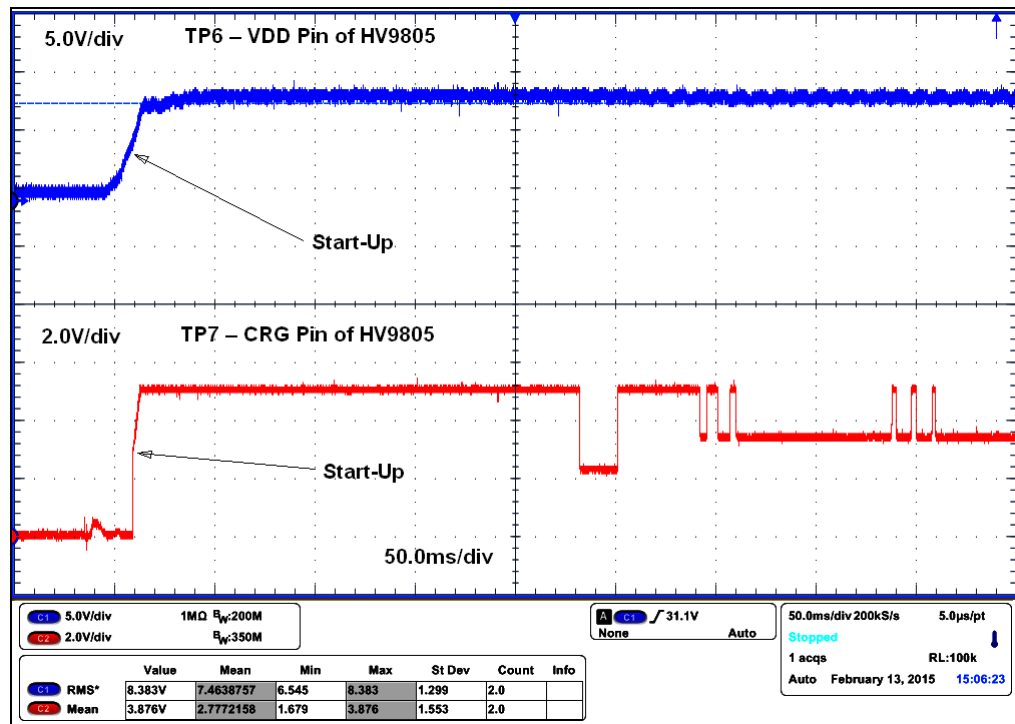

**FIGURE 2-10:** HV9805 Supply Voltage ( $V_{DD}$  pin, TP6) and Control Gate Voltage (TP7 CRG PIN) at Startup Mode.

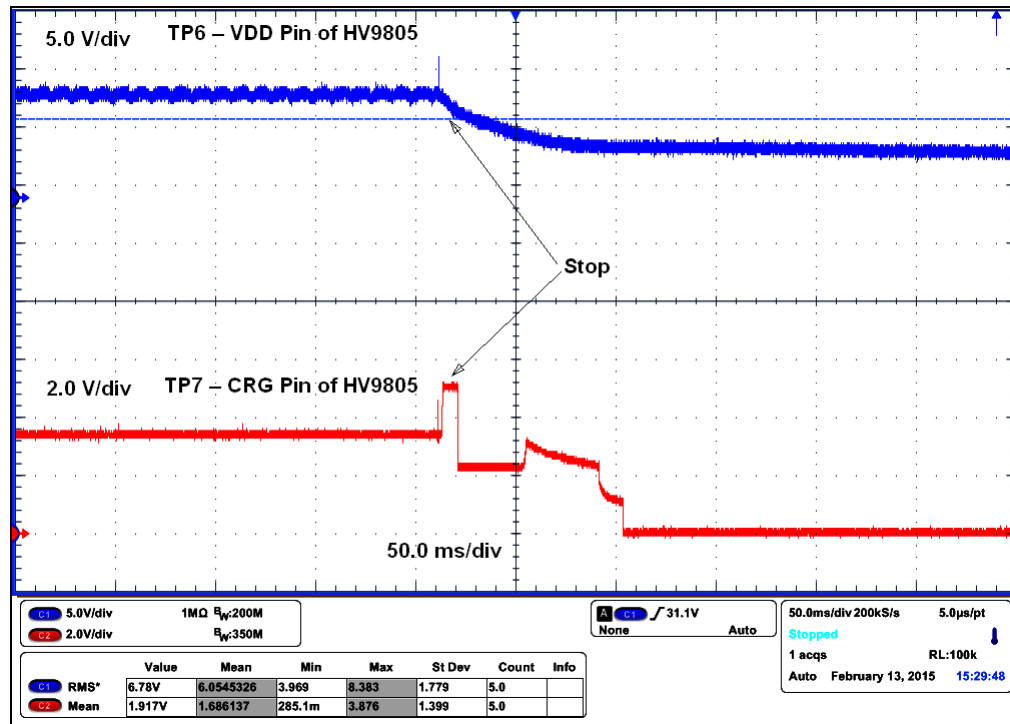

**FIGURE 2-11:** HV9805 Supply Voltage ( $V_{DD}$  pin, TP6) and Control Gate Voltage (TP7 CRG PIN) at Stop Mode.

### 2.4.3 Overall Measured Parameters

The overall parameters of the Evaluation Board are presented in Figures 2-12 – 2-16.

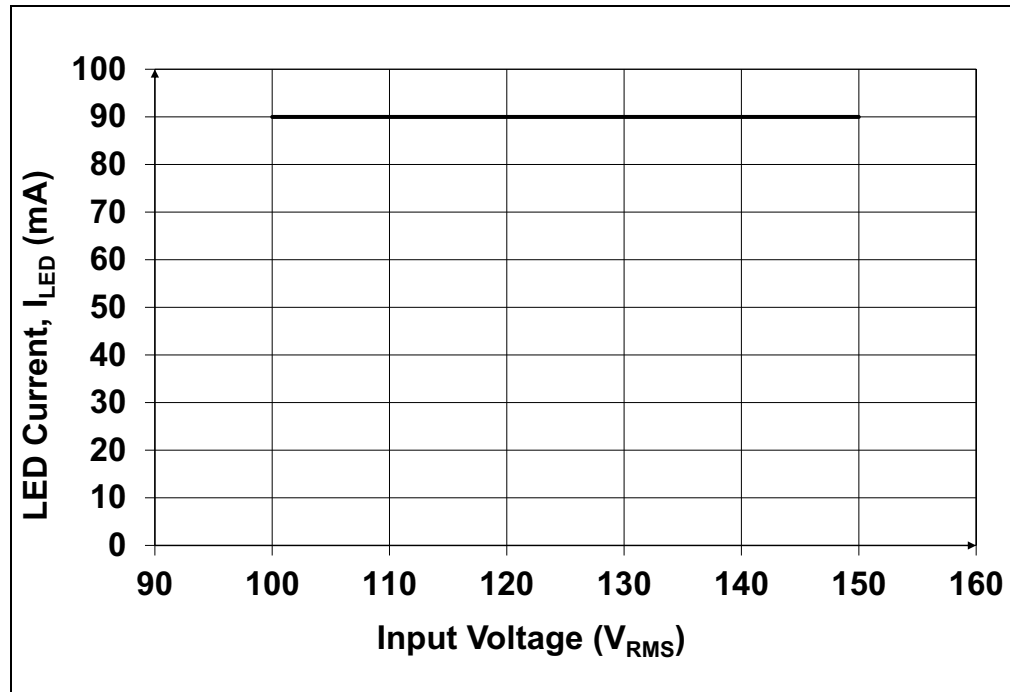

**FIGURE 2-12:** Variation of the LED Current Vs. Mains Input Voltage.



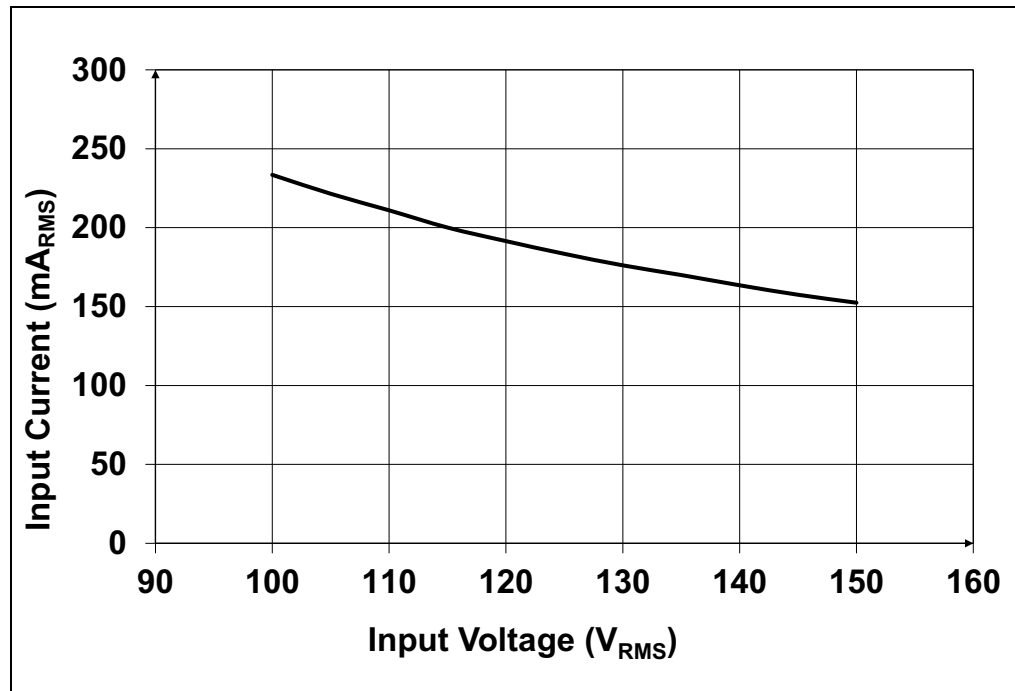

FIGURE 2-13: Variation of Input Current and Input Voltage.

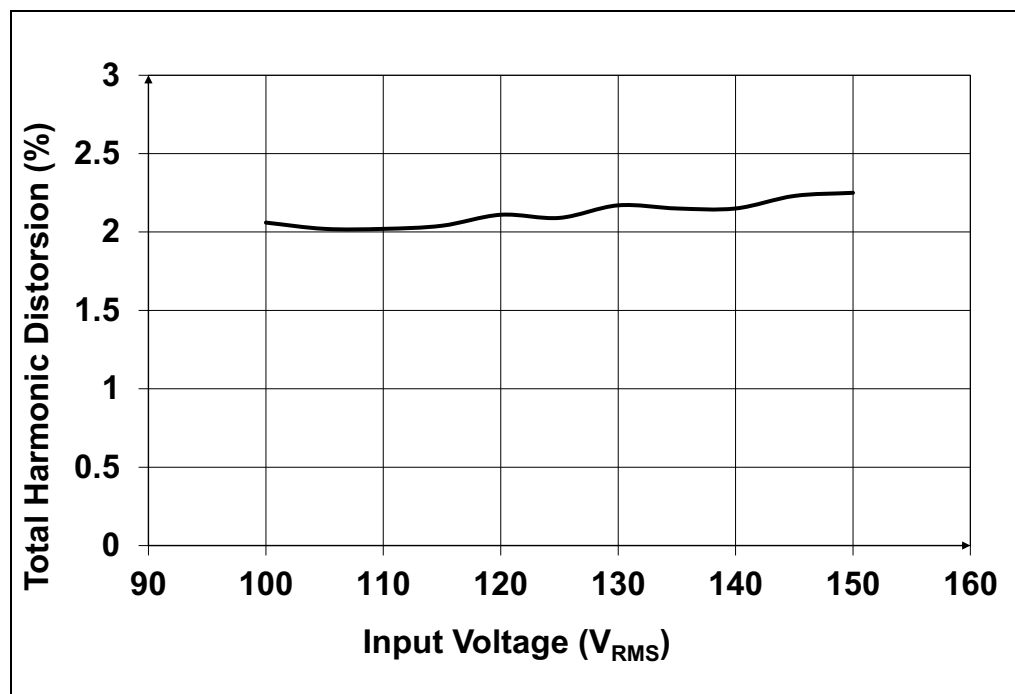

FIGURE 2-14: Total Harmonic Distortion (THD) and Input Voltage.

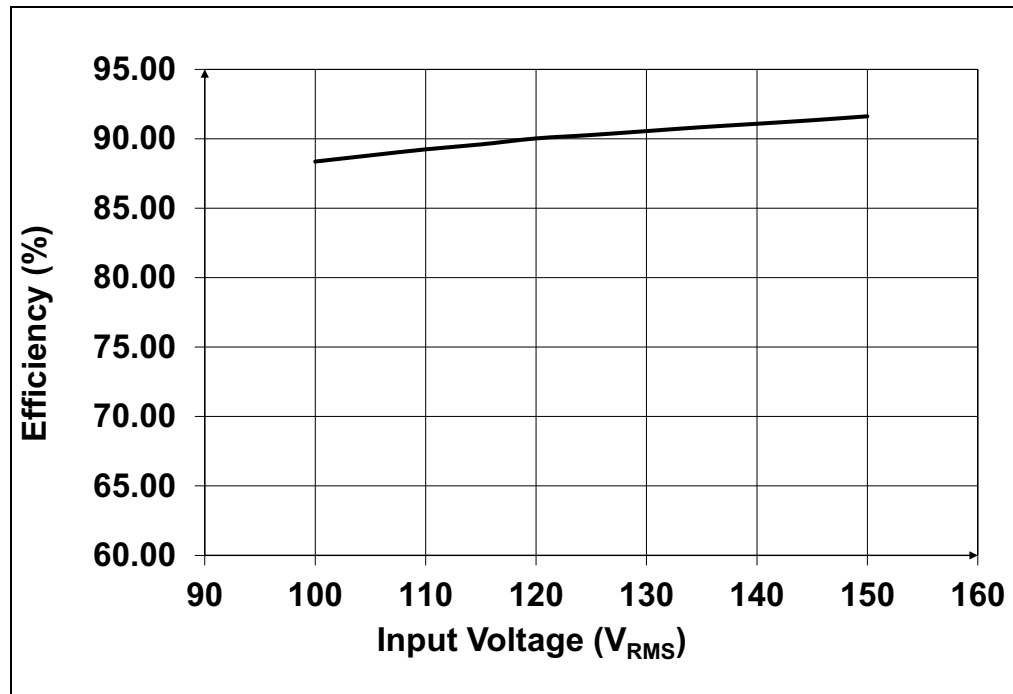

FIGURE 2-15: Efficiency and Input Voltage.

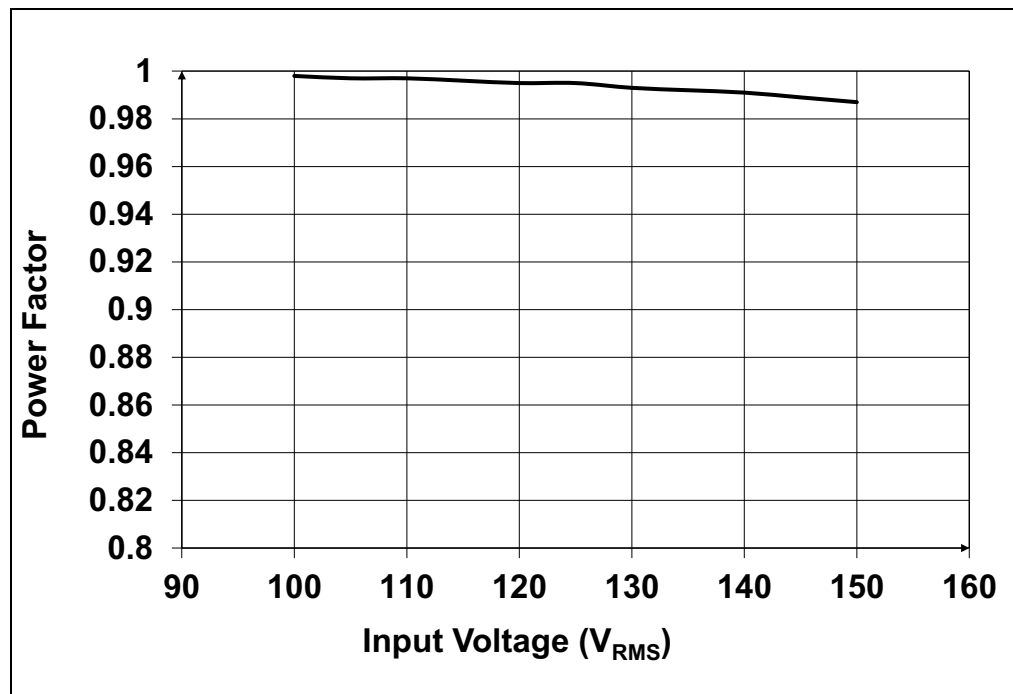

FIGURE 2-16: Power Factor (PF) and Input Voltage.



# HV9805 120V<sub>AC</sub> OFF-LINE LED DRIVER EVALUATION BOARD USER'S GUIDE

---

---

## Appendix A. Schematic and Layouts

---

---

### A.1 INTRODUCTION

This appendix contains the following schematics and layouts for the HV9805 120V<sub>AC</sub> Off-Line LED Driver Evaluation Board.

- [Board – Schematic](#)
- [Board – Top Silk](#)
- [Board – Top Copper](#)
- [Board – Bottom Copper](#)

## A.2 BOARD - SCHEMATIC

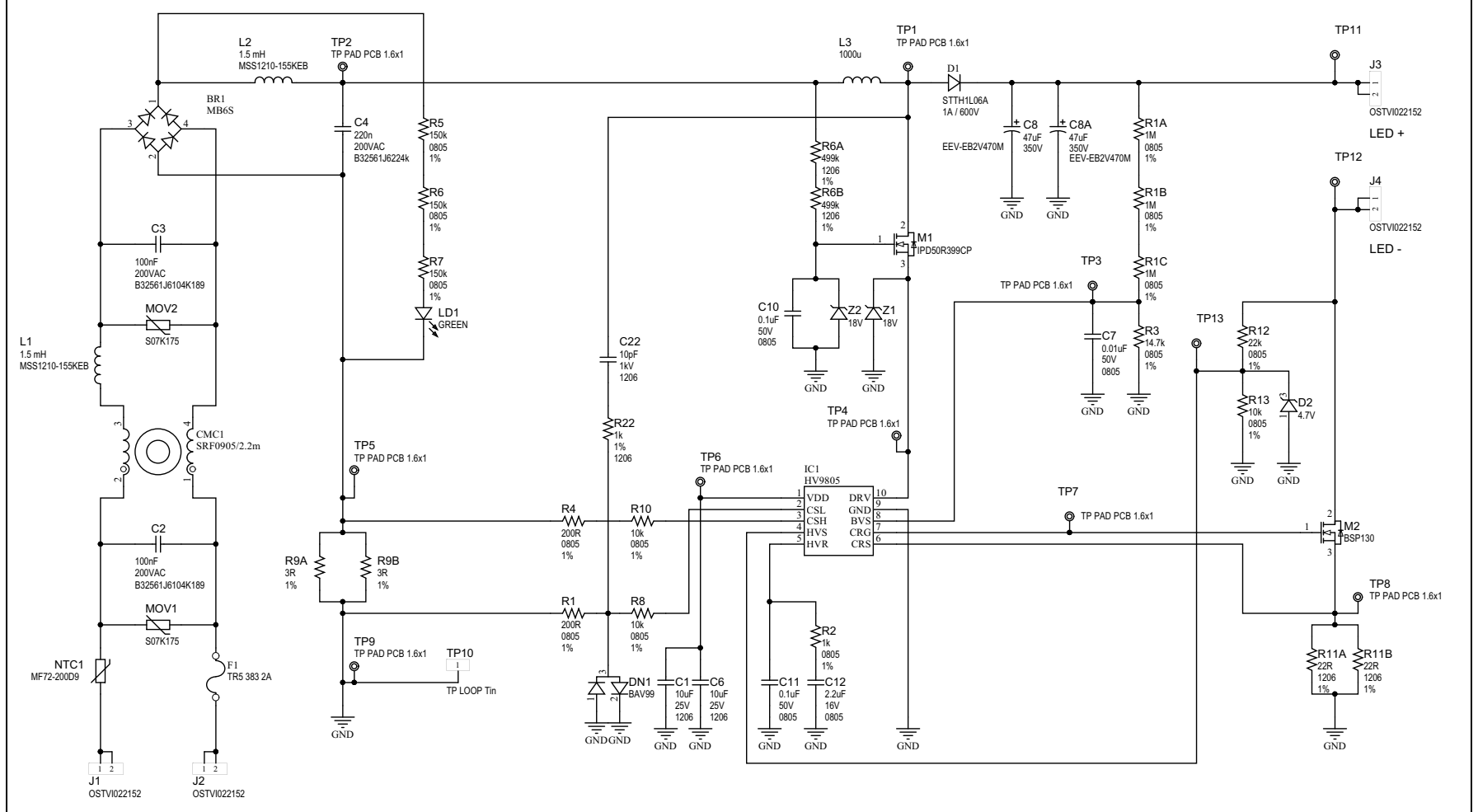

## A.3 BOARD – TOP SILK

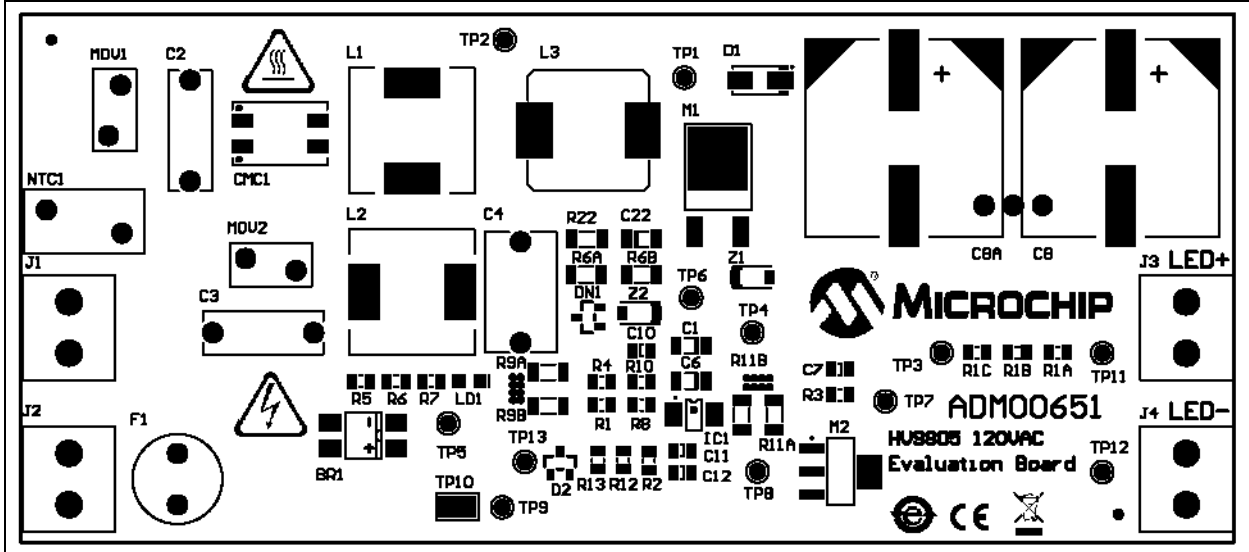

## A.4 BOARD – TOP COPPER

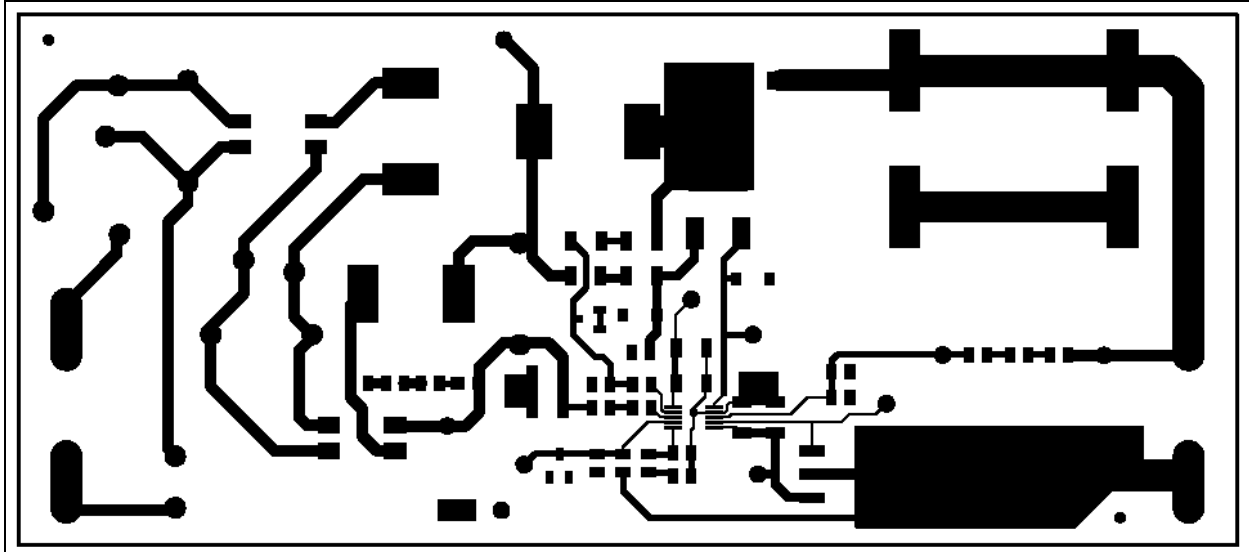

**A.5 BOARD – BOTTOM COPPER**

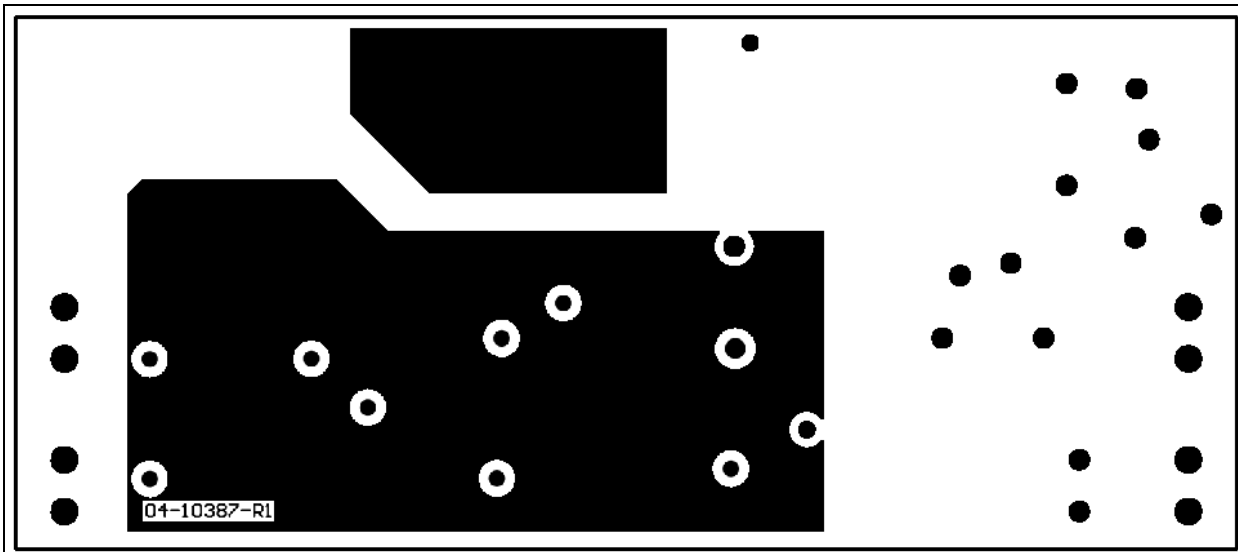



# HV9805 120V<sub>AC</sub> OFF-LINE LED DRIVER EVALUATION BOARD USER'S GUIDE

## Appendix B. Bill of Materials (BOM)

**TABLE B-1: BILL OF MATERIALS (BOM)**

Qty.	Reference	Description	Manufacturer	Part Number
1	BR1	IC RECT BRIDGE 0.5A 600V 4SOIC	Fairchild Semiconductor®	MB6S
2	C1, C6	CAP CER 10 µF 25V 10% X7R SMD 1206	Samsung Electro-Mechanics America, Inc.	CL31B106KAHNFNE
2	C2, C3	Film Capacitors 0.1 µF 400V 10%	EPCOS AG	B32561J6104K
1	C4	Film Capacitors 0.22 µF 400V 10%	EPCOS AG	B32561J6224K
1	C7	CAP CER 10 nF 50V 10% X7R SMD 0805	Kemet®	C0805C103K5RACTU
1	C8, C8A	CAP ALUM 47 µF 350V SMD	Panasonic® – ECG	EEV-EB2V470M
2	C10, C11	CAP CER 0.1 µF 50V 10% X7R SMD 0805	Yageo Corporation	CC0805KRX7R9BB104
1	C12	CAP CER 2.2 µF 16V 10% X7R SMD 0805	TDK Corporation	C2012X7R1C225K125AB
1	C22	CAP CER 10 pF 1 kV 10% C0G SMD 1206	Kemet	C1206C100KDGACTU
1	CMC1	INDUCTOR COMMON MODE 2000 UH 0.6A	Bourns®, Inc.	SRF0905-202Y
1	D1	Diode UltraFast 1A 600V 80 ns SMA	STMicroelectronics	STTH1L06A
1	D2	DIODE ZENER 4.7V 350 MW SOT23-3	Fairchild Semiconductor	BZX84C4V7
1	DN1	DIODE ARRAY GP 70V 200 MA SOT23-3	Fairchild Semiconductor	BAV99
1	F1	FUSE BOARD MOUNT 2A 300V <sub>AC</sub> RAD	Littelfuse®	38312000000
1	IC1	High Voltage LED Driver	Microchip Technology Inc.	<b>HV9805MG-G</b>
4	J1, J2, J3, J4	CON TERMINAL 5.08 mm 16A	PHOENIX CONTACT	MKDSN2, 5/2-5.08
2	L1, L2	Power Inductor 1500 µH 10% 0.81 A	Coilcraft	MSS1210-155KEB
1	L3	FIXED IND 1000 µH 0.9A 1200 mΩ	Würth Elektronik	7687709102
1	LD1	DIO LED GREEN 2V 30 mA 120 mcd Diffuse SMD 0805	Avago Technologies	HSMM-C170
1	M1	MOSFET N-CH 550V 9A TO-252	Infineon Technologies AG	IPD50R399CP-ND
1	M2	MOSFET N-CH 300V 350 MA SC73	NXP Semiconductors	BSP130

**Note 1:** The components listed in this Bill of Materials are representative of the PCB assembly. The released BOM used in manufacturing uses all RoHS-compliant components.

# HV9805 120V<sub>AC</sub> Off-Line LED Driver Evaluation Board User's Guide

**TABLE B-1: BILL OF MATERIALS (BOM) (CONTINUED)**

Qty.	Reference	Description	Manufacturer	Part Number
2	MOV1, MOV2	VARISTOR 243V 1.2 KA DISC 7 MM	EPCOS AG	S07K175
1	NTC1	CURRENT LIMITER INRSH 200Ω 20%	Cantherm	MF72-200D9
1	PCB	HV9805 120V <sub>AC</sub> Off-Line LED Driver Evaluation Board – Printed Circuit Board	Microchip Technology Inc.	04-10387
2	R1, R4	RES 200R 1% 1/8W SMD 0805	Yageo Corporation	RC0805FR-07200RL
1	R2	RES 1k 1% 1/10W SMD 0805	Yageo Corporation	RC0805FR-071KL
1	R3	RES TKF 14.7k 1% 1/8W SMD 0805	Yageo Corporation	RC0805FR-0714K7L
3	R5, R6, R7	RES 100k 1% 1/8W SMD 0805	Panasonic – ECG	RC0805FR-07100KL
1	R12	RES 22k 1% 1/8W SMD 0805	Yageo Corporation	RC0805FR-0722KL
4	R13, R8, R10	RES 10k 1% 1/16W SMD 0805	Yageo Corporation	RC0805FR-0710KL
1	R22	RES 1k 1% 1/4W SMD 1206	Yageo Corporation	RC1206FR-071KL
3	R1 A, R1B, R1C	RES 1M 1% 1/8W SMD 0805	Yageo Corporation	RC0805FR-071ML
2	R6A, R6B	RES TKF 499k 1% 1/4W SMD 1206	Yageo Corporation	RC1206FR-07499KL
2	R9A, R9B	RES TKF 3R 1% 1/4W SMD 1206	Yageo Corporation	RC0805FR-073R01L
2	R11A, R11B	RES 22R 1% 1/2W SMD 1206	Yageo Corporation	RC1206FR-0722RL
1	TP10	CON TP LOOP Tin SMD	Harwin Plc.	S1751-46R
2	Z1, Z2	DIODE ZENER 18V 500 MW SOD123	Fairchild Semiconductor	MMSZ5248B

**Note 1:** The components listed in this Bill of Materials are representative of the PCB assembly. The released BOM used in manufacturing uses all RoHS-compliant components.



# Bill of Materials (BOM)

---

---

NOTES:



# MICROCHIP

## Worldwide Sales and Service

### AMERICAS

**Corporate Office**  
2355 West Chandler Blvd.  
Chandler, AZ 85224-6199  
Tel: 480-792-7200  
Fax: 480-792-7277  
Technical Support:  
<http://www.microchip.com/support>  
Web Address:  
[www.microchip.com](http://www.microchip.com)

**Atlanta**  
Duluth, GA  
Tel: 678-957-9614  
Fax: 678-957-1455

**Austin, TX**  
Tel: 512-257-3370

**Boston**  
Westborough, MA  
Tel: 774-760-0087  
Fax: 774-760-0088

**Chicago**  
Itasca, IL  
Tel: 630-285-0071  
Fax: 630-285-0075

**Cleveland**  
Independence, OH  
Tel: 216-447-0464  
Fax: 216-447-0643

**Dallas**  
Addison, TX  
Tel: 972-818-7423  
Fax: 972-818-2924

**Detroit**  
Novi, MI  
Tel: 248-848-4000

**Houston, TX**  
Tel: 281-894-5983

**Indianapolis**  
Noblesville, IN  
Tel: 317-773-8323  
Fax: 317-773-5453

**Los Angeles**  
Mission Viejo, CA  
Tel: 949-462-9523  
Fax: 949-462-9608

**New York, NY**  
Tel: 631-435-6000

**San Jose, CA**  
Tel: 408-735-9110

**Canada - Toronto**  
Tel: 905-673-0699  
Fax: 905-673-6509

### ASIA/PACIFIC

**Asia Pacific Office**  
Suites 3707-14, 37th Floor  
Tower 6, The Gateway  
Harbour City, Kowloon  
Hong Kong  
Tel: 852-2943-5100  
Fax: 852-2401-3431

**Australia - Sydney**  
Tel: 61-2-9868-6733  
Fax: 61-2-9868-6755

**China - Beijing**  
Tel: 86-10-8569-7000  
Fax: 86-10-8528-2104

**China - Chengdu**  
Tel: 86-28-8665-5511  
Fax: 86-28-8665-7889

**China - Chongqing**  
Tel: 86-23-8980-9588  
Fax: 86-23-8980-9500

**China - Dongguan**  
Tel: 86-769-8702-9880

**China - Hangzhou**  
Tel: 86-571-8792-8115  
Fax: 86-571-8792-8116

**China - Hong Kong SAR**  
Tel: 852-2943-5100  
Fax: 852-2401-3431

**China - Nanjing**  
Tel: 86-25-8473-2460  
Fax: 86-25-8473-2470

**China - Qingdao**  
Tel: 86-532-8502-7355  
Fax: 86-532-8502-7205

**China - Shanghai**  
Tel: 86-21-5407-5533  
Fax: 86-21-5407-5066

**China - Shenyang**  
Tel: 86-24-2334-2829  
Fax: 86-24-2334-2393

**China - Shenzhen**  
Tel: 86-755-8864-2200  
Fax: 86-755-8203-1760

**China - Wuhan**  
Tel: 86-27-5980-5300  
Fax: 86-27-5980-5118

**China - Xian**  
Tel: 86-29-8833-7252  
Fax: 86-29-8833-7256

### ASIA/PACIFIC

**China - Xiamen**  
Tel: 86-592-2388138  
Fax: 86-592-2388130

**China - Zhuhai**  
Tel: 86-756-3210040  
Fax: 86-756-3210049

**India - Bangalore**  
Tel: 91-80-3090-4444  
Fax: 91-80-3090-4123

**India - New Delhi**  
Tel: 91-11-4160-8631  
Fax: 91-11-4160-8632

**India - Pune**  
Tel: 91-20-3019-1500

**Japan - Osaka**  
Tel: 81-6-6152-7160  
Fax: 81-6-6152-9310

**Japan - Tokyo**  
Tel: 81-3-6880-3770  
Fax: 81-3-6880-3771

**Korea - Daegu**  
Tel: 82-53-744-4301  
Fax: 82-53-744-4302

**Korea - Seoul**  
Tel: 82-2-554-7200  
Fax: 82-2-558-5932 or  
82-2-558-5934

**Malaysia - Kuala Lumpur**  
Tel: 60-3-6201-9857  
Fax: 60-3-6201-9859

**Malaysia - Penang**  
Tel: 60-4-227-8870  
Fax: 60-4-227-4068

**Philippines - Manila**  
Tel: 63-2-634-9065  
Fax: 63-2-634-9069

**Singapore**  
Tel: 65-6334-8870  
Fax: 65-6334-8850

**Taiwan - Hsin Chu**  
Tel: 886-3-5778-366  
Fax: 886-3-5770-955

**Taiwan - Kaohsiung**  
Tel: 886-7-213-7828

**Taiwan - Taipei**  
Tel: 886-2-2508-8600  
Fax: 886-2-2508-0102

**Thailand - Bangkok**  
Tel: 66-2-694-1351  
Fax: 66-2-694-1350

### EUROPE

**Austria - Wels**  
Tel: 43-7242-2244-39  
Fax: 43-7242-2244-393

**Denmark - Copenhagen**  
Tel: 45-4450-2828  
Fax: 45-4485-2829

**France - Paris**  
Tel: 33-1-69-53-63-20  
Fax: 33-1-69-30-90-79

**Germany - Dusseldorf**  
Tel: 49-2129-3766400

**Germany - Munich**  
Tel: 49-89-627-144-0  
Fax: 49-89-627-144-44

**Germany - Pforzheim**  
Tel: 49-7231-424750

**Italy - Milan**  
Tel: 39-0331-742611  
Fax: 39-0331-466781

**Italy - Venice**  
Tel: 39-049-7625286

**Netherlands - Drunen**  
Tel: 31-416-690399  
Fax: 31-416-690340

**Poland - Warsaw**  
Tel: 48-22-3325737

**Spain - Madrid**  
Tel: 34-91-708-08-90  
Fax: 34-91-708-08-91

**Sweden - Stockholm**  
Tel: 46-8-5090-4654

**UK - Wokingham**  
Tel: 44-118-921-5800  
Fax: 44-118-921-5820

01/27/15