A large, light blue decorative graphic consisting of a thick, curved line that forms a partial circle, with a small white circle at its top end.

Driving Low Power LEDs from 10 to 65mA LED Driver ICs with **BCR401W** and **BCR402W** Family

Application Note 182

<http://www.infineon.com/lowcostleddriver>

Rev. 1.1, 2010 -02 -11

Edition 2010.02.11

**Published by
Infineon Technologies AG
81726 Munich, Germany**

**© 2010 Infineon Technologies
AG All Rights Reserved.**

Legal Disclaimer

The information given in this document shall in no event be regarded as a guarantee of conditions or characteristics. With respect to any examples or hints given herein, any typical values stated herein and/or any information regarding the application of the device, Infineon Technologies hereby disclaims any and all warranties and liabilities of any kind, including without limitation, warranties of non-infringement of intellectual property rights of any third party.

Information

For further information on technology, delivery terms and conditions and prices, please contact the nearest Infineon Technologies Office (www.infineon.com).

Warnings

Due to technical requirements, components may contain dangerous substances. For information on the types in question, please contact the nearest Infineon Technologies Office.

Infineon Technologies components may be used in life-support devices or systems only with the express written approval of Infineon Technologies, if a failure of such components can reasonably be expected to cause the failure of that life-support device or system or to affect the safety or effectiveness of that device or system. Life support devices or systems are intended to be implanted in the human body or to support and/or maintain and sustain and/or protect human life. If they fail, it is reasonable to assume that the health of the user or other persons may be endangered.

Application Note AN182

Revision History: 2010.02.11

Previous Revision: Rev. F

Page	Subjects (major changes since last revision)
---	Update of document format
---	Addition of Table Of Contents
5	Changes to text in "Overview" section
24	Addition of section with specific example of increasing LED current with BCR401W / 402W and external current adjust resistor
12	Correction of reference designators R1 and R2 on Figure 11, Schematic Diagram of 24 Volt Striplight PCB
---	Moved section on optional Reverse Polarity Protection (RPP) after PCB schematic diagrams

Trademarks of Infineon Technologies AG

A-GOLD™, BlueMoon™, COMNEON™, CONVERGATE™, COSIC™, C166™, CROSSAVE™, CanPAK™, CIPOS™, CoolMOS™, CoolSET™, CONVERPATH™, CORECONTROL™, DAVE™, DUALFALC™, DUSLIC™, EasyPIM™, EconoBRIDGE™, EconoDUAL™, EconoPACK™, EconoPIM™, E-GOLD™, EiceDRIVER™, EUPEC™, ELIC™, EPIC™, FALC™, FCOS™, FLEXISLIC™, GEMINAX™, GOLDMOS™, HITFET™, HybridPACK™, INCA™, ISAC™, ISOFACE™, IsoPACK™, IWORX™, M-GOLD™, MIPAQ™, ModSTACK™, MUSLIC™, my-d™, NovalithIC™, OCTALFALC™, OCTAT™, OmniTune™, OmniVia™, OptiMOS™, OPTIVERSE™, ORIGA™, PROFET™, PRO-SIL™, PrimePACK™, QUADFALC™, RASIC™, ReverSave™, SatRIC™, SCEPTRE™, SCOUT™, S-GOLD™, SensoNor™, SEROCCO™, SICOFI™, SIEGET™, SINDRION™, SLIC™, SMARTi™, SmartLEWIS™, SMINT™, SOCRATES™, TEMPFET™, thinQ!™, TrueENTRY™, TriCore™, TRENCHSTOP™, VINAX™, VINETIC™, VIONTIC™, WildPass™, X-GOLD™, XMM™, X-PMU™, XPOSYS™, XWAY™.

Other Trademarks

AMBA™, ARM™, MULTI-ICE™, PRIMECELL™, REALVIEW™, THUMB™ of ARM Limited, UK. AUTOSAR™ is licensed by AUTOSAR development partnership. Bluetooth™ of Bluetooth SIG Inc. CAT-iq™ of DECT Forum. COLOSSUS™, FirstGPS™ of Trimble Navigation Ltd. EMV™ of EMVCo, LLC (Visa Holdings Inc.). EPCOS™ of Epcos AG. FLEXGO™ of Microsoft Corporation. FlexRay™ is licensed by FlexRay Consortium. HYPERTERMINAL™ of Hilgraeve Incorporated. IEC™ of Commission Electrotechnique Internationale. IrDA™ of Infrared Data Association Corporation. ISO™ of INTERNATIONAL ORGANIZATION FOR STANDARDIZATION. MATLAB™ of MathWorks, Inc. MAXIM™ of Maxim Integrated Products, Inc. MICROTEC™, NUCLEUS™ of Mentor Graphics Corporation. Mifare™ of NXP. MIPI™ of MIPI Alliance, Inc. MIPS™ of MIPS Technologies, Inc., USA. muRata™ of MURATA MANUFACTURING CO. OmniVision™ of OmniVision Technologies, Inc. Openwave™ Openwave Systems Inc. RED HAT™ Red Hat, Inc. RFMD™ RF Micro Devices, Inc. SIRIUS™ of Sirius Sattelite Radio Inc. SOLARIS™ of Sun Microsystems, Inc. SPANSION™ of Spansion LLC Ltd. Symbian™ of Symbian Software Limited. TAIYO YUDEN™ of Taiyo Yuden Co. TEAKLITE™ of CEVA, Inc. TEKTRONIX™ of Tektronix Inc. TOKO™ of TOKO KABUSHIKI KAISHA TA. UNIX™ of X/Open Company Limited. VERILOG™, PALLADIUM™ of Cadence Design Systems, Inc. VLYNQ™ of Texas Instruments Incorporated. VXWORKS™, WIND RIVER™ of WIND RIVER SYSTEMS, INC. ZETEX™ of Diodes Zetex Limited.

Last Trademarks Update 2009-10-19

Table Of Contents

Section Number / Topic	Page
Revision History	3
1. Overview	5
2. Applications Of Striplights	5
3. Description of Striplights used in this Applications Note	6
4. Details of PCB Construction	9
5. Schematic Diagram, 12 Volt Striplight	10
6. Schematic Diagram, 24 Volt Striplight	11
7. Optional Reverse Polarity Protection (RPP) with Schottky Diode(s)	12
8. Thermal Characteristics of Striplights (Thermal Resistances, Junction Temperatures, etc.)	13
9. Performance over Voltage and Temperature of Striplight modified to use traditional Resistor Biasing, vs. Performance of the same circuit using the Infineon BCR402W Constant-Current LED Driver IC.	16
10. The “Voltage Drop Problem” – The Adverse Impact of Accumulated Voltage Drops over long arrays or strings of Striplights, and how the BCR401W / 402W LED Driver ICs Eliminate the problem	
11. Procedure for Increasing Current via use of External Resistor	24
12. Bill Of Material (BOM), 12 Volt Striplight Application Board	27
13. Bill Of Material (BOM), 24 Volt Striplight Application Board	28
14. Summary and Conclusions	28
15. References	29

BCR402W Constant-Current LED Driver IC in 12V & 24V Low-Current (10 – 60mA) “Striplight” Applications offers significant advantages over resistor biasing of LED’s.

1 Introduction & Overview

LED strip lights have been penetrating several applications like channel letters for advertising due to their

- long life time in comparison to fluorescent tubes
- energy efficiency

In a very high percentage of existing LED strips, resistor biasing has been used due to the low cost of resistors. Unfortunately, LED’s should not be driven with a constant voltage source & resistor. **In order to maximize LED lifetimes and reliability, LEDs should be driven by a constant-current source, instead of a power supply & resistor combination. Resistor biasing will frequently lead to a significant reduction of the lifetime of LED’s due to a) LED’s having a Positive Temperature Coefficient with respect to current b) the statistically “wide” range of forward voltage (V_F) in a given type of LED.**

- **LED’s Positive Temperature Coefficient (PTC)**

LED’s are devices which will degrade due to their positive thermal coefficient. The warmer they get, the lower their Forward Voltage (V_F) drops and the more current they tend to draw. Increased current further heats the LED, creating a destructive “spiral” of events which can ultimately lead to a thermal runaway condition and destruction of the LED(s). This effect can be seen independently of the ambient temperature. In the case of high ambient temperature and poor thermal design, the likelihood of thermal runaway will be increased. Furthermore, the lifetime of LED’s is significantly reduced by increased device (junction) temperatures, especially at temperatures higher than 85°C.

- **The wide range of LED Forward Voltage (V_F) typically found in a given LED type**

The LED manufacturer’s range of forward voltages for a given LED type can vary significantly. As an example, a white or blue LED may specify a minimum V_F of 2.7 volts and a maximum of 3.7 volts. For a target LED current of 20mA assuming the LED’s V_F falls at the production average, the actual current seen in the actual application may vary widely, e.g. from near 10mA (with 3.7V V_F) up to 35mA (for V_F ’s of 2.7 V). **In the worst-case situation when the following effects all combine:**

- LED’s with low V_F
- High ambient temperature
- Poor or mediocre thermal design....

...the lifetime of the light using LEDs may even be lower than a light using incandescent or fluorescent sources. In this case, one of the principal advantages of using LEDs – long lifetimes – is defeated. For this reason, resistors are a poor choice for biasing LEDs.

Using the low-cost constant-current LED driver IC’s like **BCR401W** and **BCR402W** eliminate the problems described with resistor biasing of LEDs described above, since the LED drivers deliver constant-current regardless of how the LED’s forward voltages change over temperature or how the V_F ’s vary from one lot of LEDs to the next. **One additional, key feature of the BCR401W and 402W is the Negative Temperature Coefficient (NTC) of output current with respect to temperature. The slope of this**

NTC – approximately -0.2% per degree C – means that the LED’s current gradually decreases as the circuit heats up, which protects expensive LED strings from thermal runaway.

These LED drivers come in an industry-standard SOT343 package having dimensions of 2.0 x 2.1 x 0.9 mm, with a copper lead-frame to optimize / minimize thermal resistance. Maximum power dissipation is 500mW.

This Applications Note compares & contrasts standard resistor biasing versus using BCR402W in two different general-purpose low-current (20mA) “Striplight” configurations, one running from +12V DC & the other from +24V DC.

Even though the BCR401W and BCR402W have maximum input voltages of +18 Volts DC, it is possible to safely use these LED drivers in higher-voltage systems provided a simple “trick” is employed. This trick is described in Sections 3 and 7, pages 5 and 11 of this applications note.

Per data shown in this Applications Note, **using a constant-current driver like BCR402W offers several advantages over more traditional “resistor bias” schemes commonly employed for low-current LED circuits, including:**

- 1. Tighter control of LED current over variations in temperature & supply voltage.** As shown in Section 9 of this applications note, **resistor biasing yields a huge 70 – 80% variation in current, with increased current at high temperatures, tending to push the LEDs towards a potentially dangerous Thermal Runaway condition.** By contrast, using the BCR402W in the same circuit yields a current shift of ~ 30% over the same changes of voltage and temperature, with current intentionally decreasing with increasing temperature by virtue of the BCR402W’s Negative Temperature Coefficient. This negative slope of current vs. temperature, due to the LED Driver IC’s Negative Temperature Coefficient, protects LED strings from Thermal Runaway.
- 2. More homogeneous and consistent light output** between adjacent strings of LEDs as the problem of “voltage drop over the string” (discussed in Section 10) and associated current variation along a light string is eliminated,
- 3. improved LED lifetimes & reliability** due to tighter control of LED current (& thus more control over LED Junction Temperatures), as well as **prevention of Thermal Runaway of LEDs due to the BCR402W’s Negative Temperature Coefficient (NTC).**

2 Applications of Striplights

LED-based Striplights are useful for, and found in, a variety of lighting applications (**Figure 1**), including:

1. Channel Letter Lighting (used for advertising, etc.)
2. Illumination of refrigerators and freezers in supermarkets
3. Retail displays e.g. jewelry cases
4. Under-counter / cabinet lighting (residential or commercial)
5. Architectural / mood lighting.
6. In-vehicle lighting (cars, buses, trains, etc.)

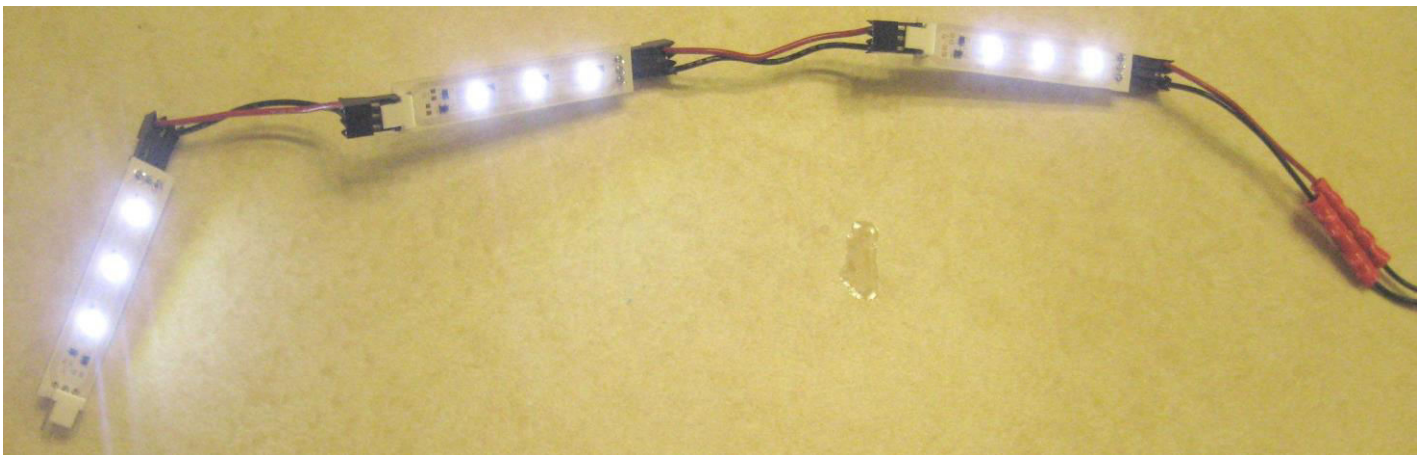
Figure 1. Some Examples of LED based Striplight Applications, including Channel Letters, Mood Lighting, and an Under-Counter Light Fixture.



3 Brief Description of Striplights shown in this Applications Note

The PC boards have DC connectors at each end, permitting the user to add or subtract Striplight segments as needed, making the overall light array longer or shorter as required to accommodate different applications such as advertising, channel letter lighting, illumination of refrigerator or freezer shelves, under-counter / cabinet lighting, jewelry displays, etc. Please refer to **Figure 2**, which shows a string of three 12-volt Striplight PCB's connected together. Again, more or fewer boards can be added or subtracted as needed by simply connecting additional PCB's with the appropriate wire harness(es). The wire harness used is shown in **Figure 18** on page 25.

Figure 2. Photo of three sections of 12 Volt "Striplight" PC Boards Connected together.



White-color **OSRAM LW T6SG TopLED LED's** are used. These LEDs have a color temperature of 5600 K, and have a low forward voltage (V_F) of 3.2 volts, making them particularly attractive for the +12V Striplight, given that the lower V_F means one can have three LED's in series, rather than only two, giving higher power efficiency. The LEDs are operated at 20mA, which is the current which these particular LEDs are mainly characterized for, as well as being the nominal (minimum) output current of the BCR402W. Note, current may be adjusted to any desired value with the BCR402W from 20 to a maximum of 60mA, by using an external resistor with the BCR402W; however one must ensure not to exceed either the LED's maximum current rating or the BCR402W's maximum power dissipation rating of

500mW. **Section 11** of this Applications Note describes the procedure for increasing current above the LED Driver's nominal / minimum current. Refer to the Striplight's schematic diagrams, **Figures 9** and **10**, on pages 11 and 12. The optional external resistor connected between pins 3 and 4 of either the BCR401W or BCR402W is the current adjust resistor. The reader is urged to consult Section 11 of this Applications Note as well as the BCR401W / 402W datasheets [1], [2] for details on resistor value selection for a given desired output current in the event a current > 10mA (BCR401W) or > 20mA (BCR402W) is required. For users who anticipate needing to run LED current as low as 10mA, the BCR401W should be used, as it has a nominal (minimum) output current of 10mA. Both BCR401W and BCR402W have the exact same footprint and pin-out configuration. Users who wish to operate their LED strings between 20 – 60mA should select the BCR402W. Photos of the two Striplight PCB designs (12 volt & 24 volt) are given in **Figures 3 – 6**. Note, the designs are essentially identical, with the 24 volt design having 6 LEDs instead of 3.

Of particular note, the 24 Volt design does not exceed the BCR402W's maximum input voltage of 18 volts, since 3 LED's are used in series between the +24V power supply rail and the power supply input pin (Pin 3) of the BCR402W. Please refer to the schematic diagram of the 24 Volt Striplight, in **Figure 11** on page 12. This technique, which uses LED's to drop the power supply voltage seen by the LED driver, permits the user to safely employ these 18-volt-rated LED drivers in higher voltage systems using power supply voltages over the maximum rating of the LED driver IC. Note, for the 24 Volt Striplight PCB, the current flowing in the "upper" LEDs (D2, D3, D4) and "lower" LEDs (D5, D6, D7) is virtually identical, with the vanishingly small difference between the two groups of LEDs typically being in the microampere range. This small difference, which is far to little to give rise to any differences in light output or quality, arises from the current consumption of the BCR401W / 402W itself. Note, in the 24 Volt PCB, both sets of LEDs – 'upper' and 'lower' - have their current tightly controlled, as the BCR402W acts as a high-impedance (load-insensitive) "current sink" for D2 – D4, and as a high impedance (load-insensitive) "current source" for D5 – D7.

Figure 3. Top (component side) of 12V Striplight.

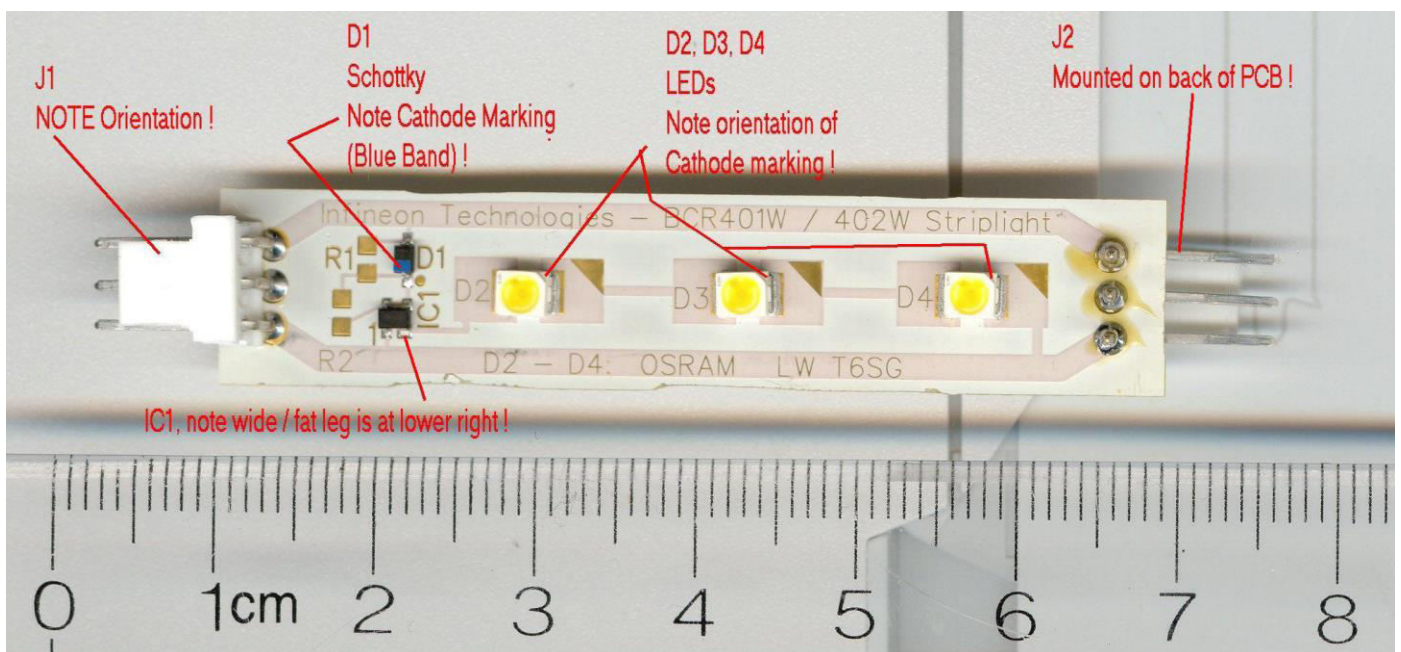


Figure 4. Bottom side of 12V Striplight.



Figure 5. Top (component side) of 24V Striplight.

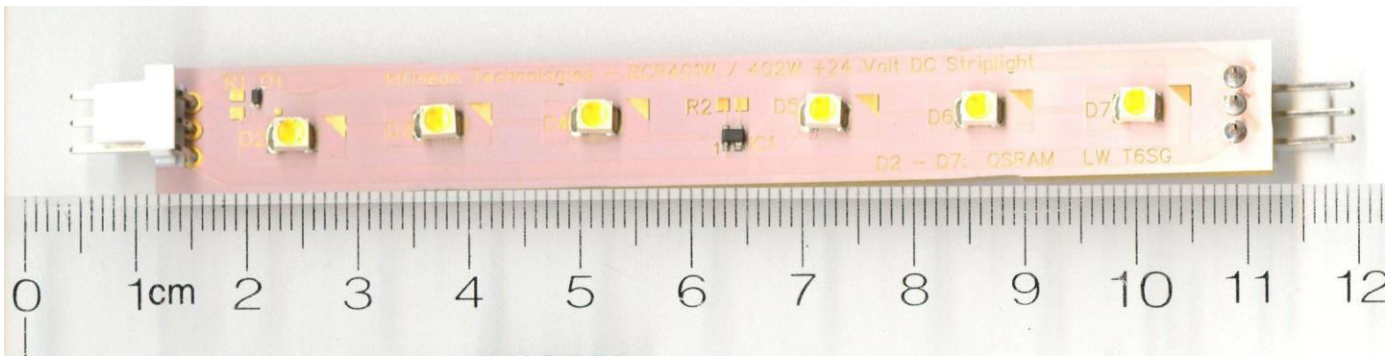
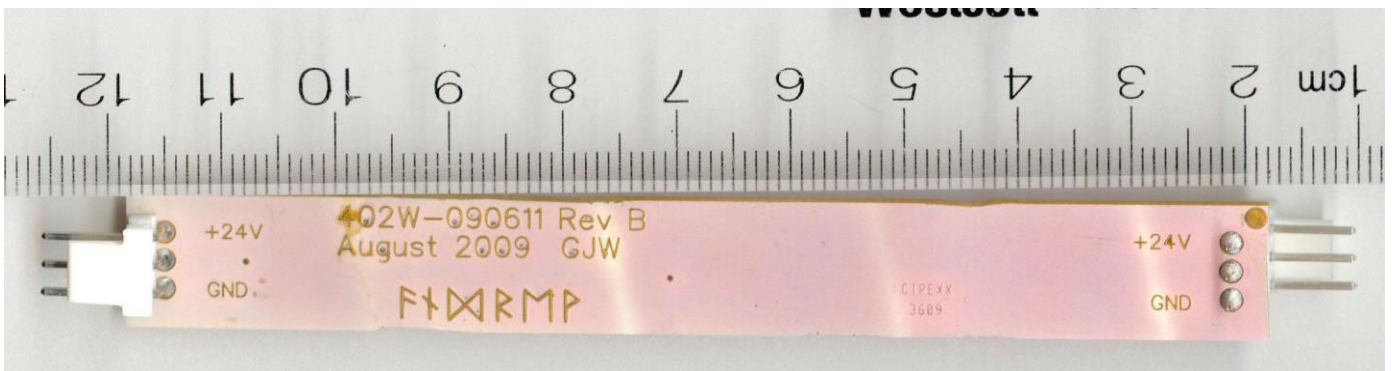


Figure 6. Bottom side of 24V Striplight.



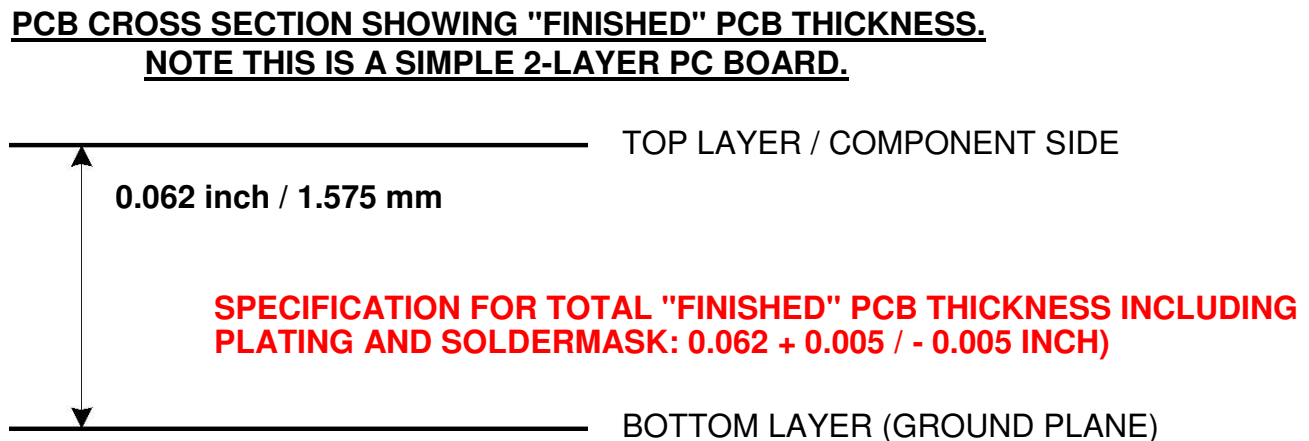
4 Details of PC Board Construction, 12 Volt and 24 Volt Designs

The PC boards use standard, low-cost “FR4” glass-epoxy material. Both PCBs use two metal layers. The 12 Volt design has a PCB thickness of 0.8 mm / 0.031 inch. As the +24 volt PC board is approximately twice as long, in order to make the board more resistant to bending and twisting, it uses a thicker dielectric of 1.6 mm / 0.062 inch. **Note, both designs utilize “2 ounce” copper plating with a finished metal thickness of 0.07 mm / 0.0028 inch.** This thicker metal plating is still a low-cost ‘standard’ metal thickness in most PCB fabrication shops, but the increased metal thickness permits heat to more easily flow out of the LEDs and LED driver IC, helping to reduce device junction temperatures. Note that the “Gerber” & other fabrication files used for the generation of the PC boards shown in this Applications Note are embedded in the “References” section of this Applications Note on page 29. [6], [7]. Cross-section diagrams for each PCB type are given in **Figures 7** and **8**.

Figure 7. Cross-Section of +12 Volt Striplight PCB.

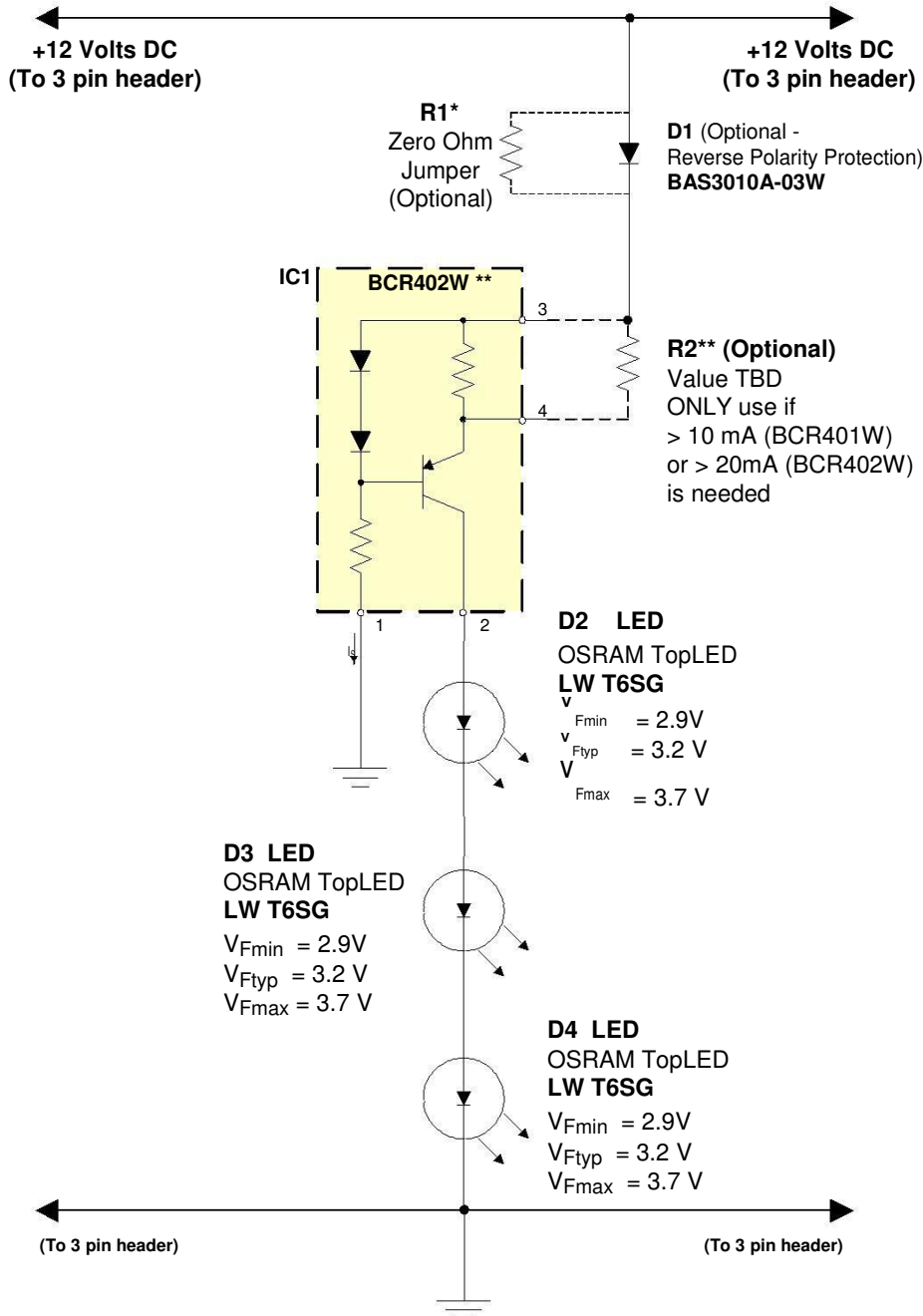


Figure 8. Cross Section of +24 Volt PCB is below. Note, dielectric thickness is doubled as compared to +12 Volt PCB to increase stiffness and decrease bending / twisting.



5 Schematic Diagram, +12 Volt Striplight

Figure 9. Schematic Diagram of 12 Volt Striplight PCB.



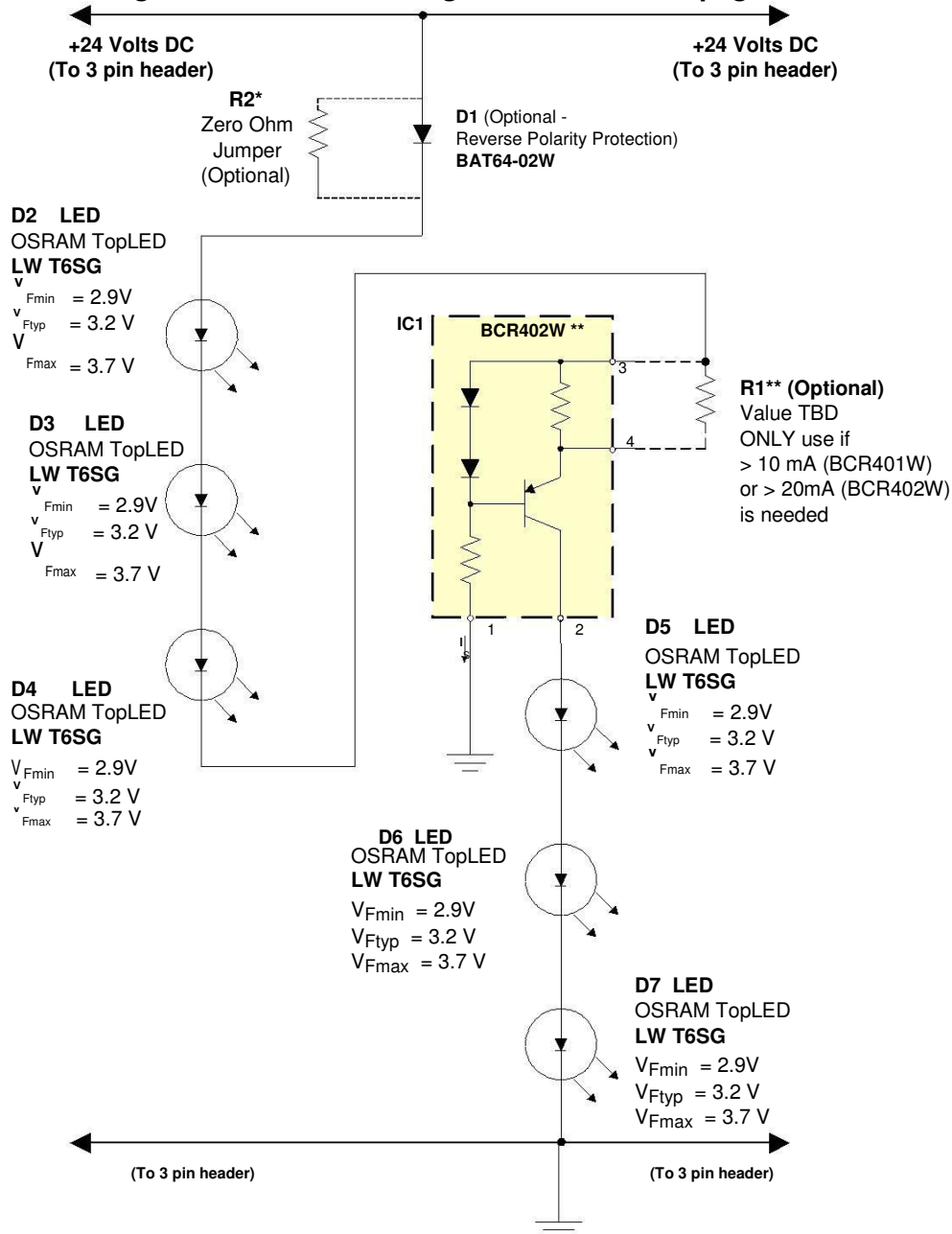
* R1 is only used if user wishes to omit D1. In this case, R1 = zero ohm jumper

** BCR401W may also be used, however to get 20mA current, an external current adjust resistor (R2) would be required. Specifically,
 a) for BCR401W: If desired current > 10mA, R2 is required. (Minimum current = 10mA).
 b) for BCR402W: If desired current > 20mA, R2 is required. (Minimum current = 20mA).
 Refer to BCR401W & BCR402W datasheets for information on selection of value of R2 to achieve a given current. Note, maximum current for BCR401W or BCR402W is 60mA.

6 Schematic Diagram, +24 Volt Striplight

Note ! The 24 Volt design simply inserts 3 LED's between power supply rail & BCR402W supply voltage pin (Pin 3). Forward drop of LED's D2, D3, and D4 reduce voltage at input of BCR402W to < 18 volts, keeping BCR402W within safe voltage limits & allowing the BCR402W to be used in 24 Volt systems.

Figure 10. Schematic Diagram of 24 Volt Striplight PCB.



* R1 is only used if user wishes to omit D1. In this case, R1 = zero ohm jumper

** BCR401W may also be used, however to get 20mA current, an external current adjust resistor (R2) would be required. Specifically,

a) for BCR401W: If desired current > 10mA, R2 is required. (Minimum current = 10mA).

b) for BCR402W: If desired current > 20mA, R2 is required. (Minimum current = 20mA).

Refer to BCR401W & BCR402W datasheets for information on selection of value of R2 to achieve a given current. Note, maximum current for BCR401W or BCR402W is 60mA.

7 Optional Reverse Polarity Protection (RPP) with Schottky Diode(s)

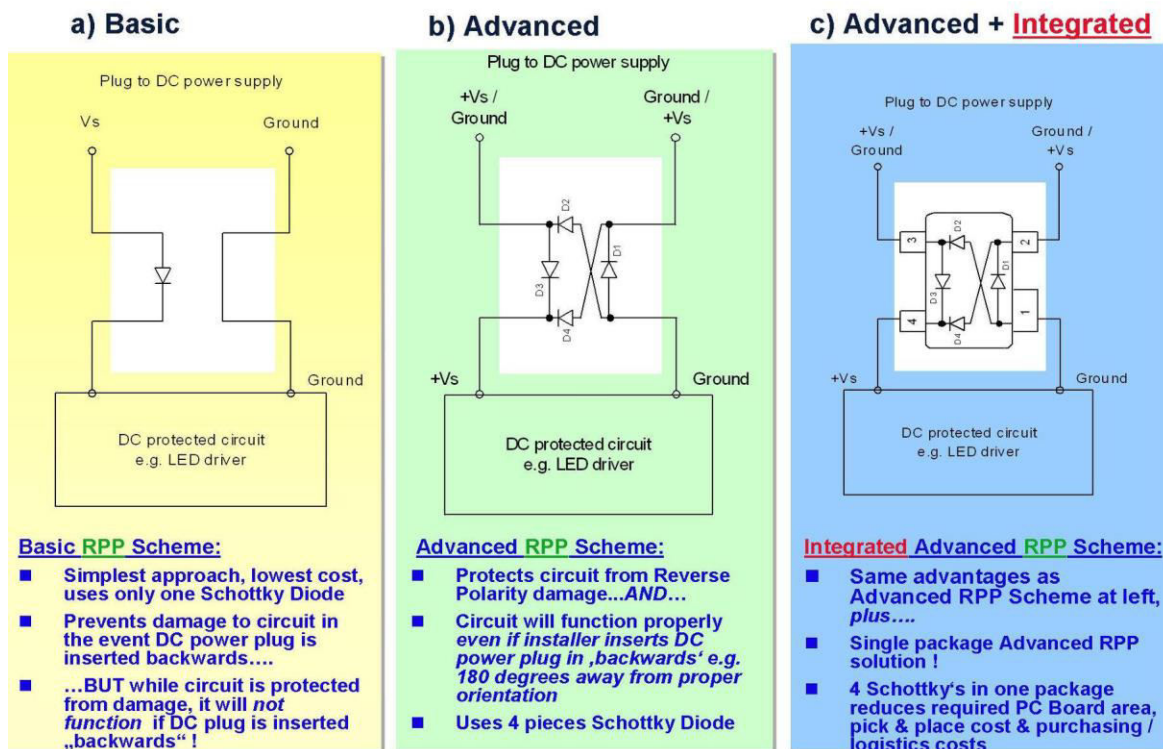
Both Striplight designs may use a single Schottky diode for what Infineon Technologies refers to as “Simple” Reverse Polarity Protection (RPP). See **Figure 11**, which shows various RPP schemes. In the “Simple RPP” scheme used in these Striplights, if the installer attaches the DC power input plug “backwards” / in the wrong way, Schottky diode D1 (refer to schematics) prevents current from flowing in the circuit, protecting the LEDs from reverse polarity induced damage. For the 12 Volt Striplight, the Infineon Technologies **BAS3010A-03W** Schottky diode is chosen; for the 24 Volt Striplight, **BAT64-02W** is selected. The reason for using two different diodes arises from a trade-off of cost vs. forward voltage. Given the forward voltage (V_F) of the LEDs, there is not as much overall voltage margin in the 12 Volt design as there is in the 24 Volt design. To ensure proper operation in “worst case” conditions – like under conditions of low temperature when LED forward voltages are highest, or when LEDs with V_F 's at the higher end of the specification range are used – the lower voltage drop of BAS3010A-03W gives more margin in the 12 Volt circuit. On the other hand, the 24 Volt circuit has more “extra” voltage available after adding up all the voltage drops of the circuit elements; thus a lower-cost Schottky diode (BAT64-02W) with a higher voltage drop may be used without concern. **Table 1** gives the voltage drops of each Schottky diode. Note, on these application circuits, if the user does not wish to use Reverse Polarity Protection, D1 may simply be omitted, and a zero ohm resistor or ‘jumper’ (R1 in 12V design, R2 in 24V PCB) is installed.

Table 1. Comparison of BAS3010A-03W and BAT64-02W Schottky diodes, used for optional Reverse Polarity Protection (RPP).

Infineon Part Number	Forward Voltage @ 20mA, 25°C, mV	Package	Relative Cost
BAT64-02W	~ 400	SCD80	Lowest
BAS3010A-03W	~ 250	SOD323	Low

Figure 11. Some possible Reverse Polarity Protection (RPP) schemes using Schottky Diodes. The simplest scheme (“Basic”, on left) is used for the two Striplight designs.

Reverse Polarity Protection („RPP“) with Schottky Diodes



8 Thermal Characteristics of 12V and 24V Striplights (Thermal Resistances, Junction Temperatures of LEDs, etc.)

The device Junction Temperatures and thermal resistances from Junction to Ambient ($R_{th J-A}$) for both an LED and the BCR402W was determined for both the 12 volt and 24 Volt PCB designs. This testing was conducted at Room Temperature ($\sim 25^{\circ}C$). A summary of the results is given in **Table 3** on page 16. Some common definitions for thermal measurements and resistances are listed here for reference:

T_J = device junction temperature inside chip (LED or BCR402W LED Driver)

T_A = ambient temperature, $^{\circ}C$

P_{TOT} = total power dissipation in a given device; for the LEDs, this is the product of the voltage across the LED multiplied by the current flowing through the LED; for the BCR402W, this value is the voltage across the BCR402W (between pins 3 and 2) times the current through the BCR402W

T_S = soldering point temperature (biggest tab on BCR402W, e.g. Pin 2; Cathode connection on LEDs)

$R_{th J-A}$ = thermal resistance from device junction to ambient (dependent on PCB construction, etc.)

$R_{th S-A}$ = thermal resistance from device soldering point to ambient (dependent on PCB construction, etc.)

Note: $R_{th J-A} = R_{th J-S} + R_{th S-A}$ and $R_{th S-A} = (T_S - T_A) / P_{TOT}$

$R_{th J-S}$ = thermal resistance from device junction to soldering point (given in device datasheets, **not dependent upon PCB construction**)

Determine device junction temperatures from this formula: $T_J = T_S + P_{TOT} \times R_{th J-S}$

Determine thermal resistance from LED junction to Ambient: $R_{th J-A LED} = R_{th J-S LED} + R_{th S-A LED}$

Determine thermal resistance from BCR402W junction to Ambient: $R_{th J-A BCR} = R_{th J-S BCR} + R_{th S-A BCR}$

The procedure taken for the Application Circuits shown in this document is outlined as follows:

a. **Determination of Soldering Point Temperature of LED (T_{SLED}):** one thermocouple wire is attached to the LED's cathode connection to PCB (with solder). One of the LEDs closest to the center of the PCB was chosen, as this would likely represent a "worst case" location with the highest temperatures.

b. **Determination of Soldering Point Temperature of BCR402W ($T_{S BCR402W}$):** A second thermocouple wire is attached (soldered) to the current output pin (Pin 2) of the BCR402W.

c. Striplight is turned on, and allowed to run for 30 minutes, to **ensure PC board reaches steady-state or equilibrium conditions**. Note, the PCB assembly is clamped in a vise with rubber grips; the rubber contact points have extremely high thermal resistance, and the contact area between the PCB and the vise is very small, so the measurement should suffer minimal error from being held in the vise. Please refer to **Figure 12** on the next page. **Soldering point temperatures for a. and b. above are recorded.** **Table 2** on the following page summarizes the measurement results.

Figure 12. Photo of a 24 Volt Striplight undergoing thermal testing.

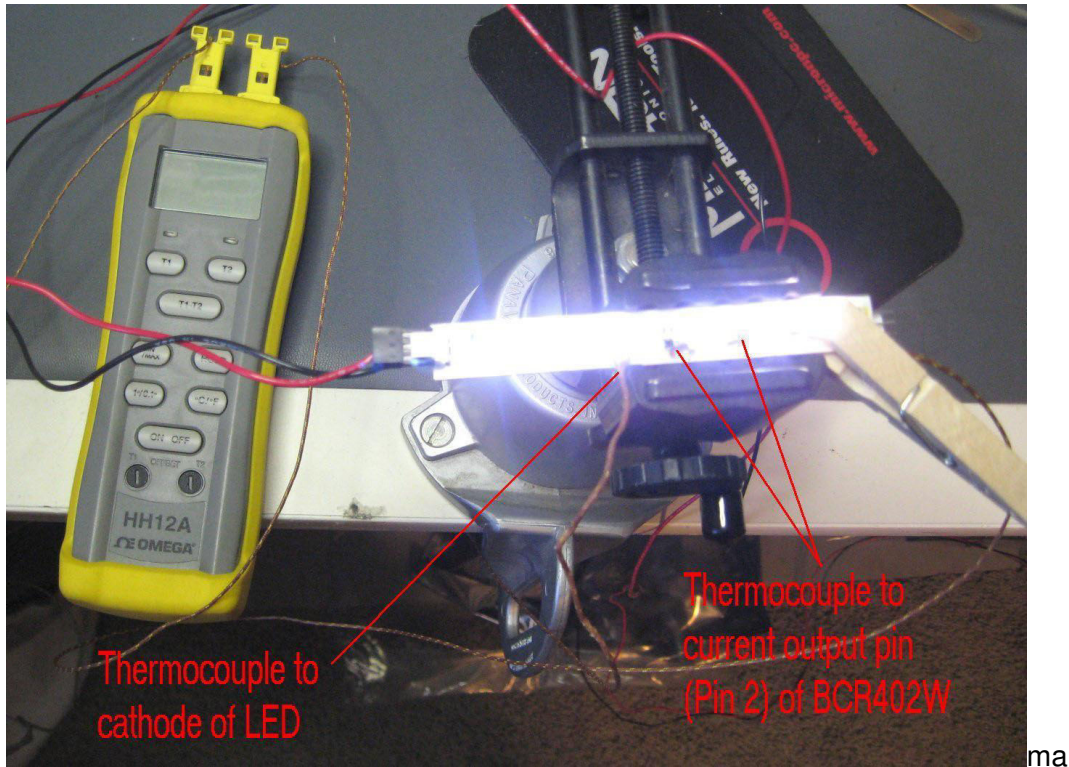


Table 2. Soldering Point Temperatures (T_S) of LED and BCR402W as measured for both 12 Volt and 24 Volt PCB designs, running at $\sim 20\text{mA}$, in $T = 25^\circ\text{C}$ ambient temperature conditions. Power supply voltages are fixed at 12.0 or 24.0 volts. Also listed is the power dissipation (P_{TOT}) in each device, along with each devices thermal resistance from Junction to Soldering Point ($R_{th\ J-S}$) which are taken from device datasheets.

	12 Volt Striplight PCB	24 Volt Striplight PCB
$T_{S\ LED}$	35°C	37°C
$T_{S\ BCR402W}$	37°C	41°C
Voltage across LED	2.98 V	2.97 V
Voltage across BCR402W (Pins 3 to 2)	2.90 V	5.98 V
Current	20.4 mA	21.2 mA
$P_{TOT\ LED}$	60.8 mW	63.0 mW
$P_{TOT\ BCR402W}$	59.2 mW	126.8mW

Note – maximum permitted dissipation in the LEDs is 185mW for $T_A = 25^\circ\text{C}$; maximum permitted power dissipation in BCR402W is 500mW for $T_S < 95^\circ\text{C}$. Refer to device datasheets.

A. Calculation of Junction Temperatures of LED and BCR402W:

For the 12 Volt Striplight PC Boards:

a) LED: $T_{J LED} = T_S LED + P_{TOT LED} \times R_{TH J-S LED}$ Note $R_{TH J-S LED}$ is given in Device Datasheet as $180^{\circ}C/W$
 $T_{J LED} = 35^{\circ}C + (0.0608W)(180^{\circ}C/W)$

$T_{J LED} = 45.9^{\circ}C$, which is 79.1 degrees below the maximum permitted junction temperature of $125^{\circ}C$

b) BCR402W: $T_{J BCR} = T_S BCR + P_{TOT BCR} \times R_{TH J-S BCR}$ Note $R_{TH J-S LED}$ is $110^{\circ}C/W$ from datasheet
 $T_{J BCR} = 37^{\circ}C + (0.0592W)(110^{\circ}C/W)$

$T_{J BCR} = 43.5^{\circ}C$, which is 106.5 degrees below maximum permitted junction temperature of $150^{\circ}C$

For the 24 Volt Striplight PC Boards:

a) LED: $T_{J LED} = T_S LED + P_{TOT LED} \times R_{TH J-S LED}$ Note $R_{TH J-S LED}$ is given in Device Datasheet as $180^{\circ}C/W$
 $T_{J LED} = 37^{\circ}C + (0.063W)(180^{\circ}C/W)$

$T_{J LED} = 48.3^{\circ}C$, which is 76.7 degrees below the maximum permitted junction temperature of $125^{\circ}C$

b) BCR402W: $T_{J BCR} = T_S BCR + P_{TOT BCR} \times R_{TH J-S BCR}$ Note $R_{TH J-S LED}$ is $110^{\circ}C/W$ from datasheet
 $T_{J BCR} = 41^{\circ}C + (0.1268W)(110^{\circ}C/W)$

$T_{J BCR} = 54.9^{\circ}C$, which is 95.1 degrees below maximum permitted junction temperature of $150^{\circ}C$

B. Calculation of Thermal Resistance from Junction to Ambient ($R_{TH J-A}$) of LED and BCR402W:

Note, $R_{TH J-A} = R_{TH J-S} + R_{TH S-A}$; we must determine $R_{TH S-A}$ for both the LED and the BCR402W on each type of Striplight (12 and 24 volt types).

For the 12 Volt Striplight PC Boards:

a) LED: $R_{TH S-A (LED)} = (T_S - T_A) / P_{TOT LED}$
 $R_{TH S-A (LED)} = (35^{\circ}C - 25^{\circ}C) / (0.0608W) = 164.5^{\circ}C/W$
 $R_{TH J-A (LED)} = R_{TH J-S (LED)} + R_{TH S-A (LED)} = 180^{\circ}C/W + 164.5^{\circ}C/W = \underline{\underline{344.5^{\circ}C/W}}$

b) BCR402W: $R_{TH S-A (BCR)} = (T_S - T_A) / P_{TOT BCR}$
 $R_{TH S-A (BCR)} = (37^{\circ}C - 25^{\circ}C) / (0.0592W) = 202.7^{\circ}C/W$
 $R_{TH J-A (BCR)} = R_{TH J-S (BCR)} + R_{TH S-A (BCR)} = 110^{\circ}C/W + 202.7^{\circ}C/W = \underline{\underline{312.7^{\circ}C/W}}$

For the 24 Volt Striplight PC Boards:

- a) LED: $R_{TH\ S-A\ (LED)} = (T_S - T_A) / P_{TOT\ LED}$
 $R_{TH\ S-A\ (LED)} = (37^\circ\text{C} - 25^\circ\text{C}) / (0.063\text{W}) = 190.5\ ^\circ\text{C/W}$
 $R_{TH\ J-A\ (LED)} = R_{TH\ J-S\ (LED)} + R_{TH\ S-A\ (LED)} = 180^\circ\text{C/W} + 190.5\ ^\circ\text{C/W} = \underline{370.5\ ^\circ\text{C/W}}$
- b) BCR402W: $R_{TH\ S-A\ (BCR)} = (T_S - T_A) / P_{TOT\ BCR}$
 $R_{TH\ S-A\ (BCR)} = (41^\circ\text{C} - 25^\circ\text{C}) / (0.1268\text{W}) = 126.2\ ^\circ\text{C/W}$
 $R_{TH\ J-A\ (BCR)} = R_{TH\ J-S\ (BCR)} + R_{TH\ S-A\ (BCR)} = 110^\circ\text{C/W} + 126.2\ ^\circ\text{C/W} = \underline{236.2\ ^\circ\text{C/W}}$

Table 3. Summary of Junction Temperatures and Thermal Resistances for both the 12 Volt and 24 Volt Striplight Designs at 20mA operation. Ambient Temperature (T_A) for these results is 25°C.

	12 V Striplight		24V Striplight	
$T_J\ LED$	45.9 °C		48.3 °C	
$T_J\ BCR402W$	43.5 °C		54.9 °C	
$R_{TH\ S-A\ (LED)}$	164.5 °C/W		190.5 °C/W	
$R_{TH\ S-A\ (BCR)}$	202.7 °C/W		126.2 °C/W	
$R_{TH\ J-A\ (LED)}$	344.5 °C/W		370.5 °C/W	
$R_{TH\ J-A\ (BCR)}$	312.7 °C/W		236.2 °C/W	

9 Performance over Voltage & Temperature of Striplight modified to use traditional RESISTOR Biasing, versus Performance of the same circuit using the Infineon BCR402W Constant-Current LED Driver IC

One sample of each of a 12 Volt PCB and a 24 Volt PCB was **modified to remove the BCR402W LED Driver, & replace the LED Driver IC with a fixed resistor**. Both the modified circuit boards with resistor bias, and the standard board with BCR402W installed are tested over voltage (12 or 24 Volts +/- 5%) & temperature (-40 to +85C) in a temperature test chamber, with results given in **Tables 4 and 5** on the following pages. A photo of the modified 12 volt circuit is in **Figure 13**, showing how the BCR402W has been removed, and a zero ohm jumper and 130 ohm resistor is connected. In addition, a schematic diagram for the modified 12 volt PCB (with 130 ohm resistor instead of BCR402W) is given in **Figure 14**, showing how voltages across circuit elements vary over temperature, when the power supply voltage is held constant at 12 or 24 volts. **Figure 15** shows a 12 Volt circuit, but with the BCR402W installed, along with the various circuit element voltages at -40, +25 and +85°C, again with the power supply voltage held constant, for comparison.

Of particular interest to the reader should be the variation in LED forward voltage ($V_F\ LED$) with temperature changes. The LED's forward voltage decreases as the LED heats up. This variation in LED V_F is a key issue with regard to biasing of LEDs, and the decreasing V_F of LEDs as temperature increases can contribute to thermal runaway and destruction of LEDs, particularly in circuits using simple resistor bias. The constant-current drive of the BCR402W, combined with the BCR402W's Negative Temperature Coefficient (NTC), eliminates the potential problem of thermal runaway, and using the BCR402W drastically reduces LED current variation over temperature and supply voltage as compared with resistor biasing.

Table 4. LED Current Variation, 12 Volt Striplight, using RESISTOR biasing (left side) and BCR402W LED Driver. For data on left, BCR402W LED Driver IC has been removed, and a 130 ohm resistor put in its place to yield ~ 20mA current at 12.0 Volts, 25°C. Note the large variation in current when resistors are used, and the much improved stability of LED current over both voltage and temperature with the BCR402W.

12 Volt Striplight Board Resistor Bias – 130 Ω Resistor			12 Volt Striplight Board With BCR402W LED Driver	
Ambient Temperature, °C	Supply Voltage, Volts	LED Current, mA	LED Current, mA	
-40	11.4	12.3	23.3	
-40	12.0	15.3	23.6	
-40	12.6	19.0	23.7	
+25	11.4	17.0	20.7	
+25	12.0	20.1	20.7	
+25	12.6	24.9	20.8	
+85	11.4	20.7	17.0	
+85	12.0	24.6	17.1	
+85	12.6	28.7	17.2	

Worst-case variation with resistor bias = $(28.7 - 12.3) / 20.1 \Rightarrow$ **81.5 % variation !**

Worst-case variation with BCR402W bias = $(23.7 - 17.0) / 20.7 \Rightarrow$ **32.4 % variation, much improved.**
Also note, the Negative Temperature Coefficient (NTC) of the BCR402W circuit, which helps to prevent Thermal Runaway in LEDs.

Figure 13. Photo of a 12 Volt Striplight PCB, modified by removing the BCR402W LED Driver IC, and replacing the BCR402W with a 130 ohm resistor. A zero ohm “jumper” was also needed to complete the connections.



Figure 14. Schematic of 12 Volt Striplight with Resistor Bias. In this test, supply voltage was held constant at +12.0 Volts while Striplight was in a temperature test chamber that varied from -40 to +85°C. Test wires from each node on PC board passed out of temperature chamber's access port, allowing the various component voltages to be monitored over temperature. Note extreme variation of LED Forward Voltage (V_F) over temperature, which is very typical of LEDs. This variation in V_F can give rise to bias point instability over operating conditions, unless a constant-current LED Driver like the BCR402W is used.

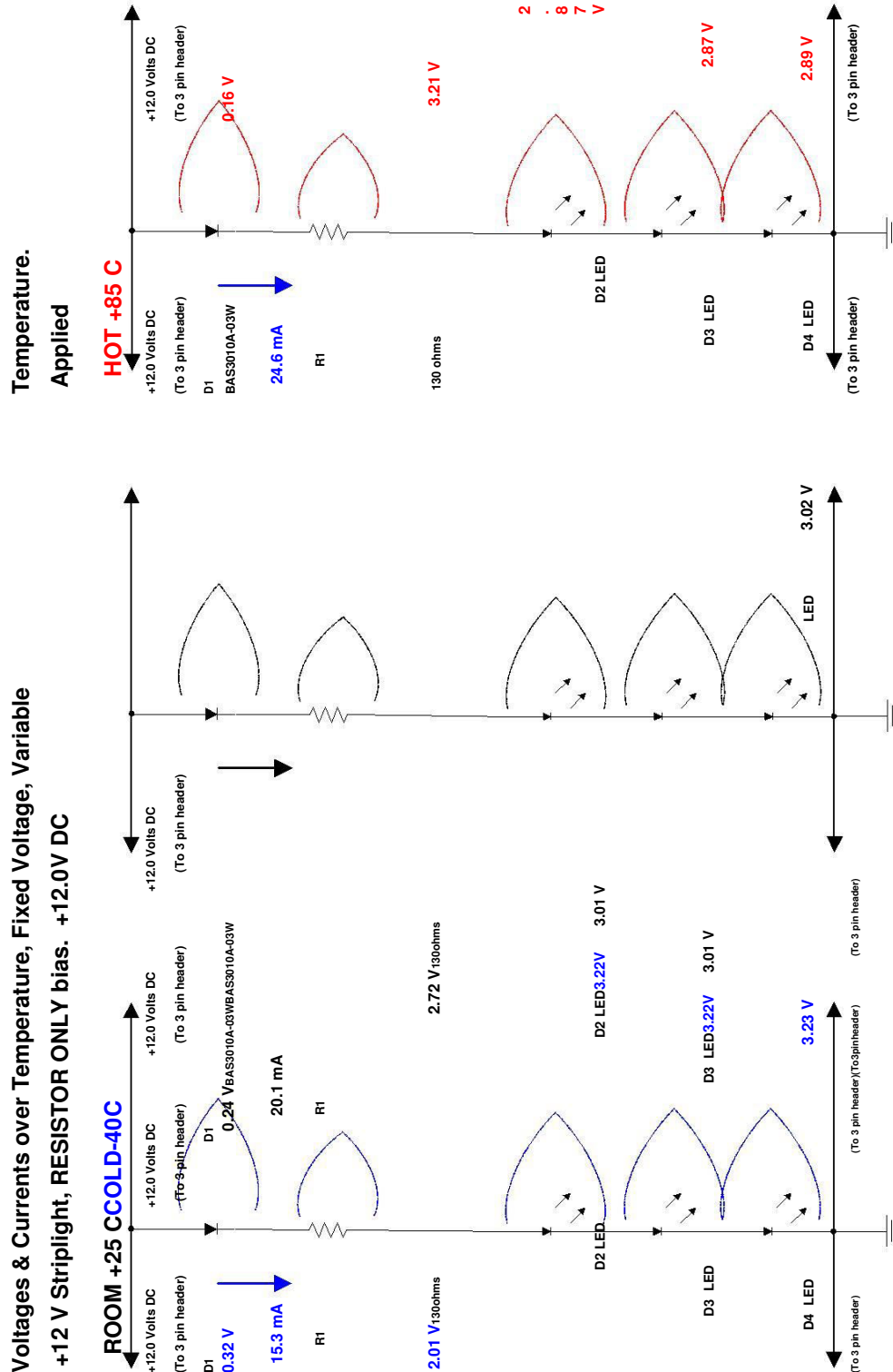


Figure 15. Schematic of 12 Volt Striplight with BCR402W Bias. Supply voltage was held constant at +12.0 Volts while Striplight was in a temperature test chamber that varied from -40 to +85°C. Test wires from each node on PC board passed out of temperature chamber's access port, allowing the various component voltages to be monitored over temperature. Note extreme variation of LED Forward Voltage (V_F) over temperature, which is very typical of LEDs. This variation in V_F can give rise to bias point instability over operating conditions, unless a constant-current LED Driver like the BCR402W is used.

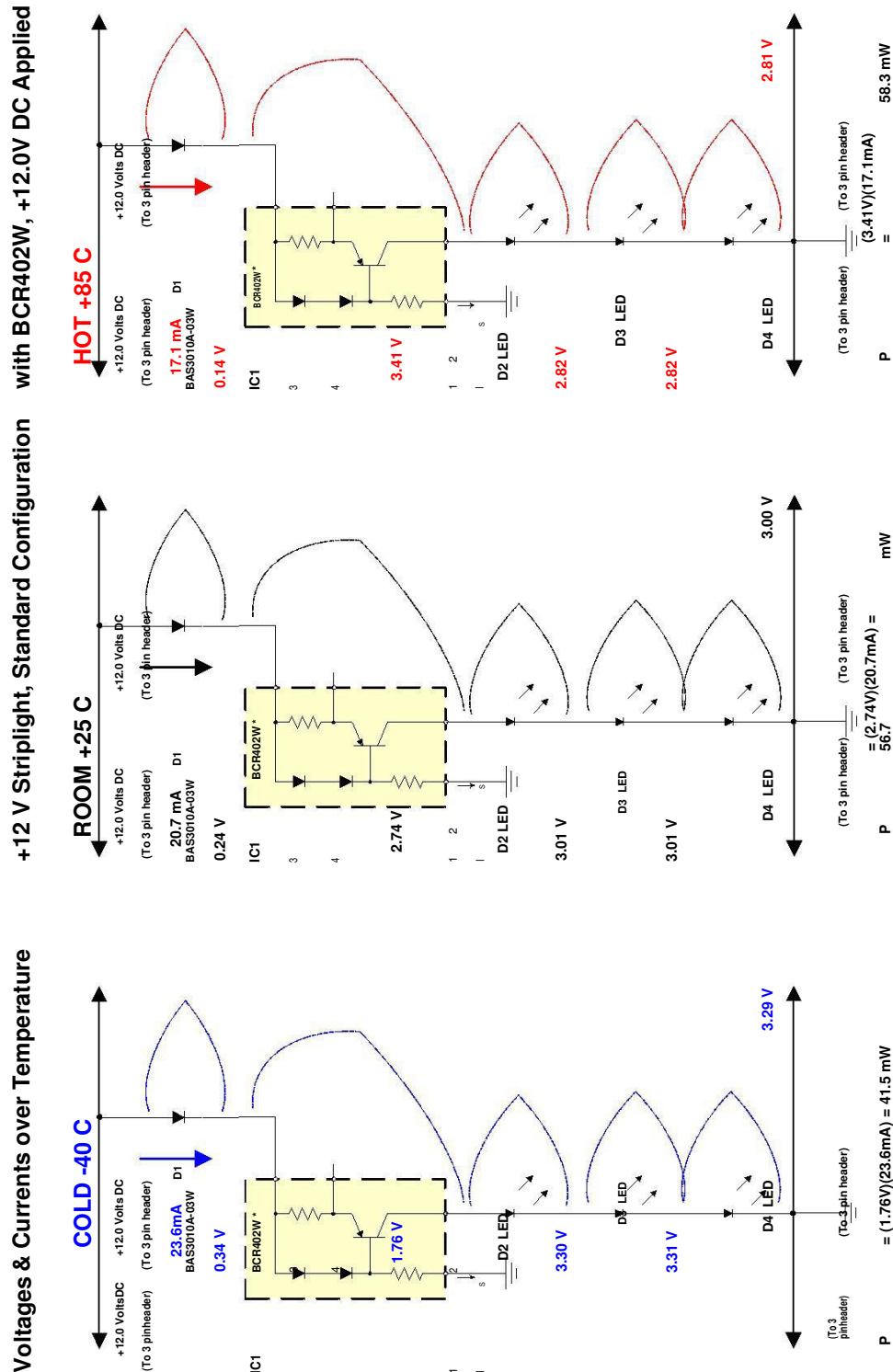


Table 5. LED Current Variation, 24 Volt Striplight, using RESISTOR biasing (left side) and BCR402W LED Driver. For data on left, BCR402W LED Driver IC has been removed, and a 300 ohm resistor put in its place to yield ~ 20mA current at 24.0 Volts, 25°C. Note large variation in current when resistors are used, and the much improved stability of LED current over both voltage and temperature with the BCR402W.

24 Volt Striplight Board Resistor Bias – 300 Ω Resistor			24 Volt Striplight Board With BCR402W LED Driver	
Ambient Temperature, °C	Supply Voltage, Volts	LED Current, mA	LED Current, mA	
-40	22.8	13.7	24.3	
-40	24.0	17.1	24.5	
-40	25.2	20.6	24.6	
+25	22.8	17.0	21.0	
+25	24.0	20.5	21.2	
+25	25.2	24.1	21.5	
+85	22.8	20.1	18.1	
+85	24.0	23.8	18.3	
+85	25.2	27.6	18.5	

Worst-case variation with resistor bias = $(27.6 - 13.7) / 20.5 \Rightarrow 67.8\%$ variation !

Worst-case variation with BCR402W bias = $(24.6 - 18.1) / 21.2 \Rightarrow 30.6\%$ variation, much improved. Also note, the Negative Temperature Coefficient (NTC) of the BCR402W circuit, which causes current to decrease at higher temperatures, thereby helping to prevent Thermal Runaway in LEDs.

10 The “Voltage Drop Problem“ – The Adverse Impact of Accumulated Voltage Drops over long arrays or strings of Striplights, and how the BCR401W / BCR402W LED Driver ICs eliminate the problem

In some lighting applications employing Striplights, e.g. Channel Letters, long arrays or strings of Striplights must be used. Generally, the string is fed DC power at one end, meaning that, *as current flows from the end of the array nearest the power supply down towards the far end of the array, a voltage drop or voltage loss accumulates.*

If resistors are used for biasing the LEDs, and the same value resistor is used in each Striplight section (as would be required for manufacturing / cost considerations), the sections farthest from the power supply will draw less current than the sections closer to the power supply. **This problem of voltage drop can give rise to a gradient in light output over the length of the array (inhomogeneous or varying light output from one end of the array to the other). On the other hand, if a constant-current LED driver like the BCR402W is used, LED current will be very consistent from section to section, regardless of accumulated voltage drop, as long as sufficient voltage is available to turn on each circuit section.** A photo showing 50 pieces of the 12 Volt Striplights connected in an array is given in **Figure 16**. The voltage available across each of the 50 Striplight sections is measured with a Digital Multi Meter (DMM) and listed in **Table 6**. A plot of available voltage vs. the position of the Striplight PC Board (board numbers 1 through 50, with #1 being closest to the power supply) is given in **Figure 17**. It can be seen that over 50 Striplights, there is approximately a 1 volt drop or loss of available voltage. The reader should

bear in mind that, this 1 volt of total drop occurs when each individual Striplight only draws ~ 20mA. The wire harnesses (**Figure 18**) that are closest to the power supply carry the most current; as one moves from the power supply towards the end of the array, the total current carried by the wire + PCB traces decreases. The wire harnesses used here are constructed of stranded 22 AWG wire and crimp connectors rated at 4 amperes. One can imagine how much more severe the voltage drop would be, if the LED currents were higher, and / or lower-cost, smaller-diameter wire were used. Again, *due to the voltage drop issue, resistor bias of the individual Striplight sections would cause LED current at the Strip sections most distant from the power supply to have less current than the sections closer to the power supply. On the other hand, using the BCR402W constant-current LED Driver forces all Striplight sections to have equal LED current regardless of how few or how many Striplight sections are added or subtracted, as long as the available voltage is high enough to ensure proper operation of the BCR401W / 402W, e.g. the available voltage needs to be higher than the sum of a) LED forward voltages, b) (optional) voltage drop of Reverse Polarity Protection Schottky diode, and c) overhead voltage of BCR402W (~ 1.2 Volts).*

Figure 16. 50 sections of 12 Volt Striplight are connected. The available voltage across each Striplight is measured with a Digital Multimeter. Striplight sections furthest away from power supply input at the top of the photo have lower voltage available to them than the sections closest to the power supply (at bottom of photo), due to voltage drop in the connecting wire harnesses as well as voltage drops on the PCB traces. Using the BCR402W instead of Resistor biasing forces each section to have equal LED current, regardless of the voltage drops.



Table 6. Available voltage across each PC Board in a string of 50 striplights as shown in Figure 14.

PCB #	Voltage Across PCB (Volts)
1	12.01
2	11.97
3	11.93
4	11.90
5	11.86
6	11.83
7	11.79
8	11.76
9	11.72
10	11.69
11	11.66
12	11.62
13	11.59
14	11.56
15	11.53
16	11.51
17	11.48
18	11.45
19	11.43
20	11.41
21	11.38
22	11.35
23	11.33
24	11.31
25	11.29

PCB #	Voltage Across PCB (Volts)
26	11.27
27	11.25
28	11.23
29	11.21
30	11.20
31	11.18
32	11.17
33	11.15
34	11.14
35	11.13
36	11.11
37	11.10
38	11.09
39	11.08
40	11.07
41	11.07
42	11.06
43	11.05
44	11.05
45	11.04
46	11.04
47	11.03
48	11.03
49	11.03
50	11.03

Figure 17. Available Voltage across Striplight boards, numbers 1 – 50 in a long string or array. Board #1 (left side of graph) is closest to power supply, Board #50 is at end of array (right side of graph). Note voltage “sag” or drop. Voltage drop in this example is relatively minimal as each PCB only draws ~ 20mA, and the wire used is 22AWG. With higher LED current, or if lower-cost, higher resistivity wire were used, voltage drop would be far more pronounced.

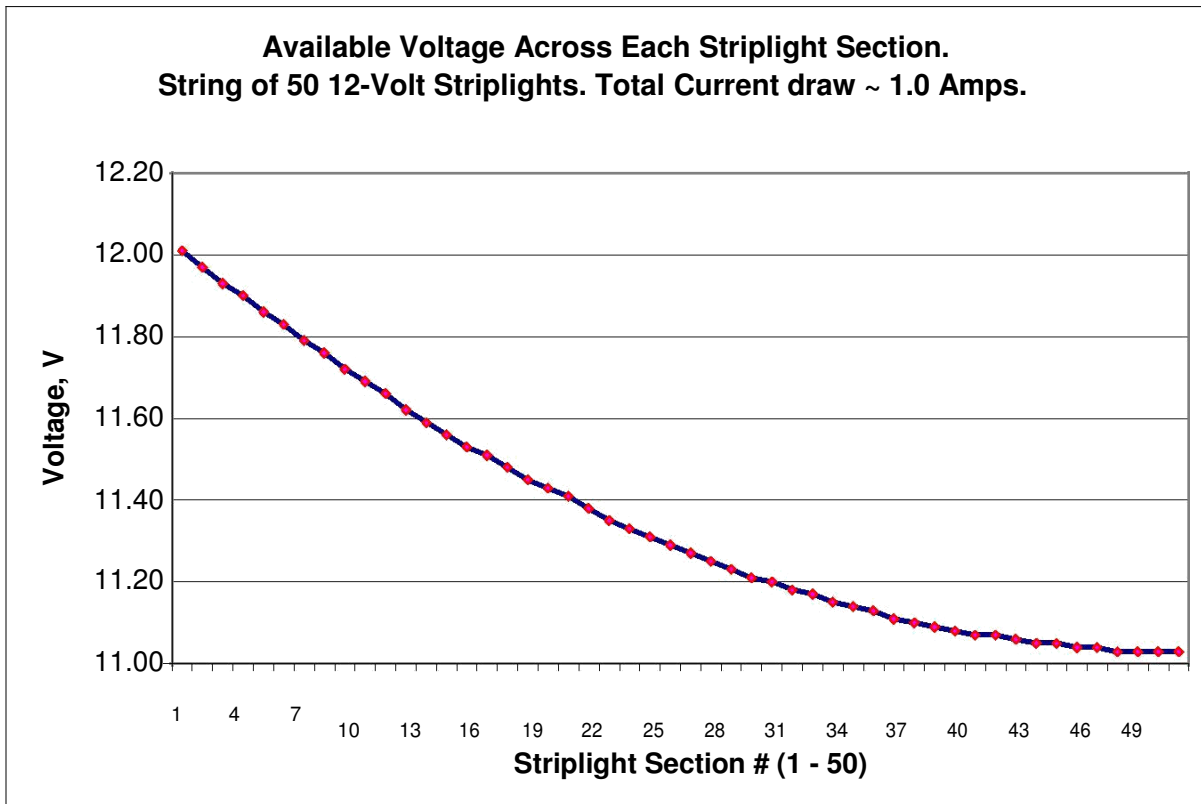
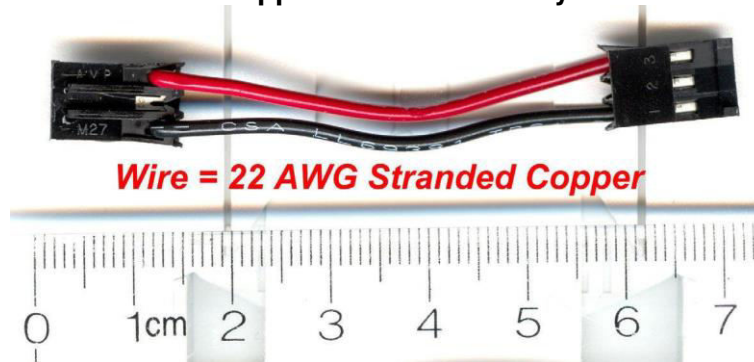


Figure 18. DC Wire Harness used to connect Striplight Boards. Note, this harness uses thicker gauge wire than would be used in a real, cost-sensitive commercial Striplight application, meaning that voltage drops seen in a real-world application would likely be worse than shown in Table 6.

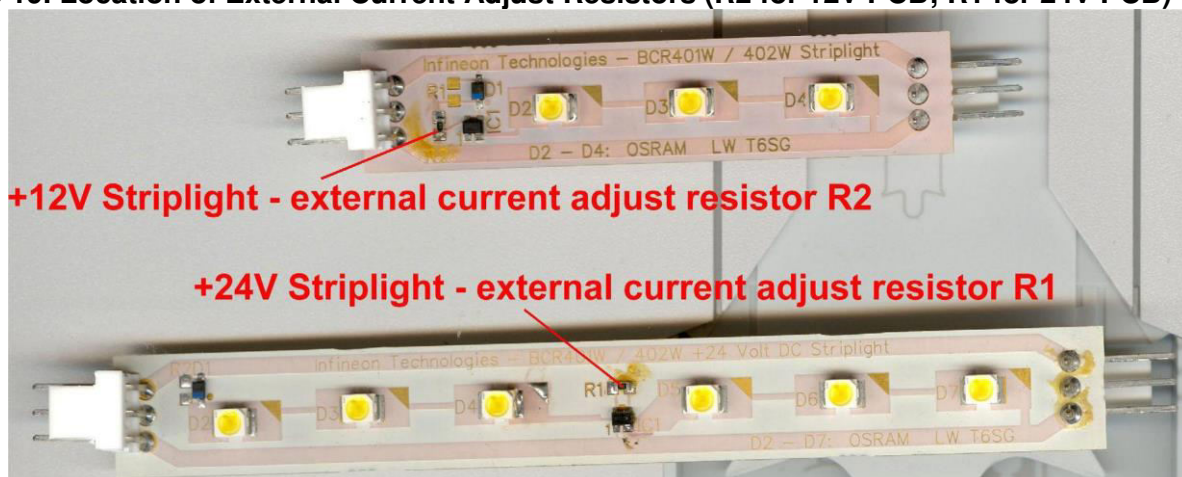


11 Procedure for Increasing Current via use of External Resistor

BCR401W and BCR402W each have nominal (minimum) output currents when no external current adjust resistor is used. The BCR401W has a minimum output current of 10mA whereas the BCR402W minimum output current is 20mA. If the user wishes to increase current beyond the device’s nominal output current, it is very easy to do so, using just a single external resistor connected between pins 3 and 4 of either device. The LED driver’s nominal output current with no external resistor is primarily determined by the value of an internal, integrated resistor within either the BCR401W or BCR402W chip. When the user places an external resistor in parallel to the LED driver’s internal resistor by connecting an external resistor between pins 3 and 4, the composite or net resistance between pins 3 and 4 is decreased, which increases the LED driver’s output current. *Note – as BCR401W and BCR402W each have different internal resistor values, the external resistor value selected to achieve a given target output current will be differ between BCR401W and BCR402W. The user must ensure that under all conditions, 1) the LED driver’s maximum output current of 60mA is not exceeded and 2) the LED driver’s maximum power dissipation of 500mW is not exceeded.* The BCR401W or BCR402W power dissipation is simply the product of (Output Current) x (Voltage across pins 2 and 3).

The following step-by-step example shows the procedure for selecting an appropriate external resistor value to increase LED current from the nominal ~ 20mA of the BCR402W to ~ 37mA. The resistor used for increasing current on the 12V Striplight PCB is R2; on the 24 Volt Striplight it is R1. Please refer to **Figure 19**.

Figure 19. Location of External Current Adjust Resistors (R2 for 12V PCB; R1 for 24V PCB)



Procedure:

1. Decide what output current is needed. In this example, we want a current of ~ 37mA.
2. Refer to the curve in the device datasheet entitled “Output Current vs. External Resistor”. These curves, while in the device datasheets, are also shown in **Figure 20** for reference. **Figure 21** shows the same plot for the BCR402W only, with markings in red color for the selected operating point used in this example (~ 37mA) and corresponding external resistor value (43 Ω)..
3. Locate the desired output current on the Y axis (37mA in this example), move straight across to the right to intersect the curve, then drop straight down to the X axis to read off the desired external resistor value. In our example here for a desired output current of ~ 37mA, an external resistor value of approximately 42 - 43 ohms is read off from the curves. The nearest standard resistor value was selected (43 ohms in this case.)

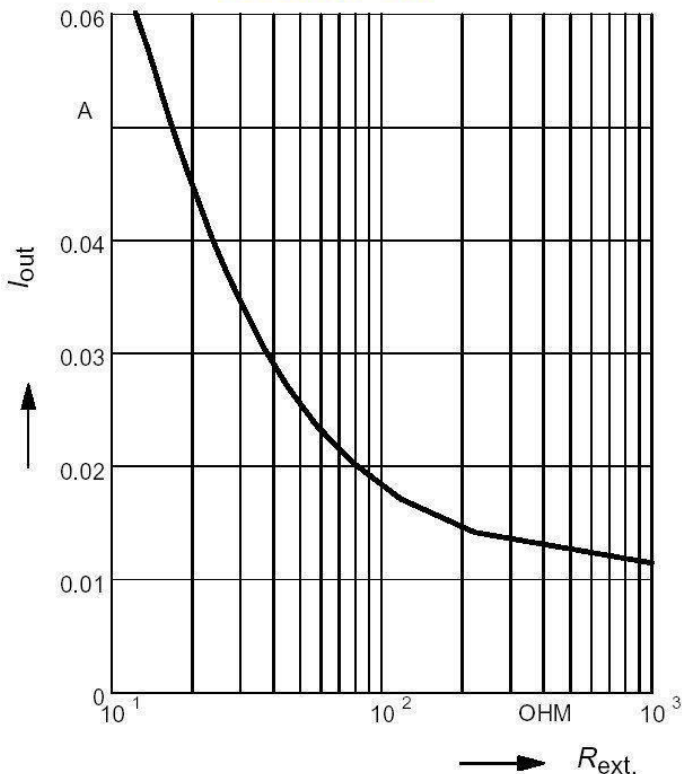
One example of a 12V Striplight and a 24V Striplight was modified per this procedure, and the resulting output currents are tabulated in **Table 7** on the following page. Note the close agreement between the datasheet curve and resulting output currents on the actual Striplights.

Figure 20. LED Output Current vs. External Current Adjust Resistor Value, for BCR401W and BCR402W. Taken from BCR401W and BCR402W datasheets. Note logarithmic scale used on x-axis for external resistor value!

Output current versus external resistor

$$I_{out} = f(R_{ext}); V_S = 10V; V_{out} = 7.6V$$

BCR401W



Output current versus external resistor

$$I_{out} = f(R_{ext}); V_S = 10V; V_{out} = 7.6V$$

BCR402W

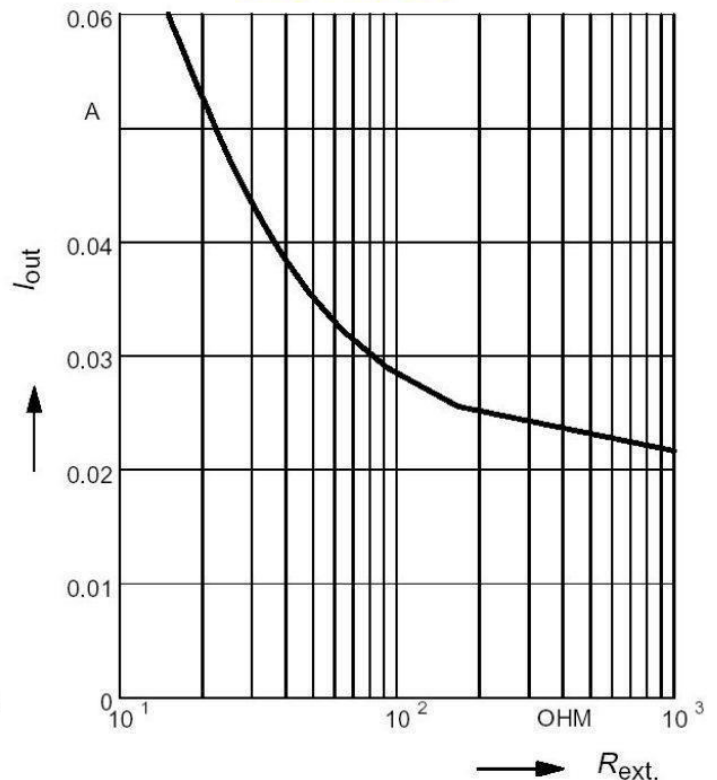


Figure 21. Curve from BCR402W datasheet “Output Current vs. External Resistor” showing operating point selected for the example in this section with red color lines. Note logarithmic scale of x-axis for external resistor value R_{ext} .

Output current versus external resistor

$$I_{out} = f(R_{ext}); V_S = 10V; V_{out} = 7.6V$$

BCR402W

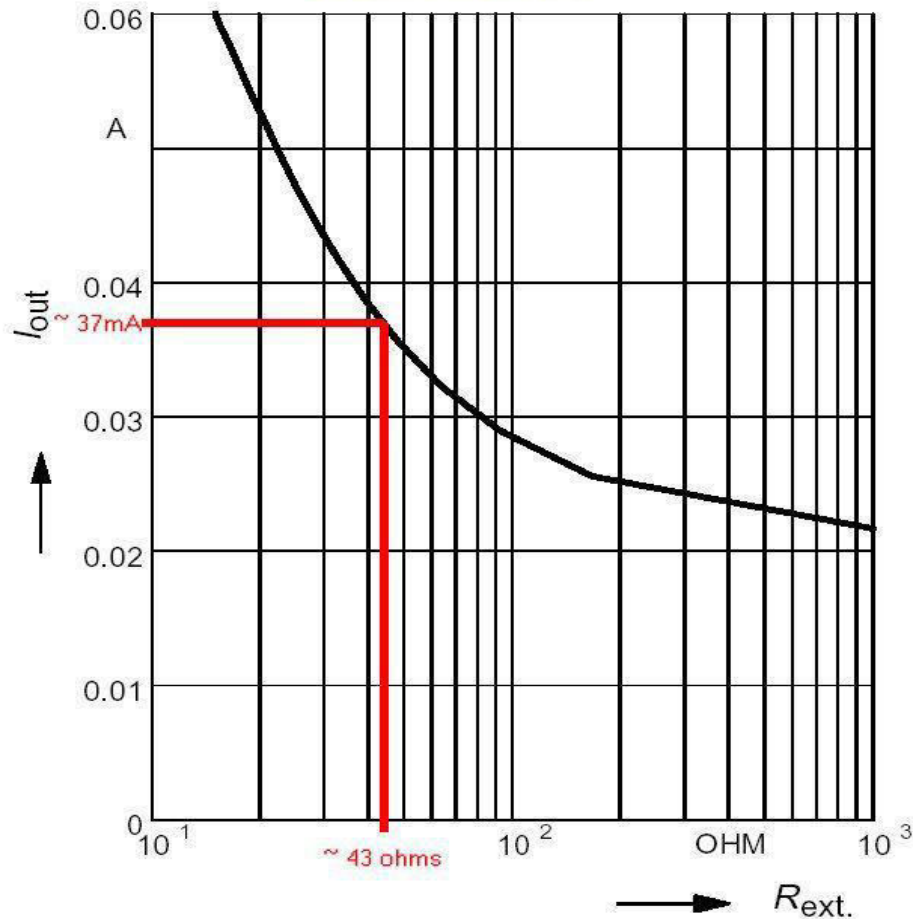


Table 7. Results, example using External Resistor to increase LED current from nominal 20mA of BCR402W to target of ~ 37mA. External resistor = 43 Ω . External resistor values for a given output current are different for BCR401W & BCR402W ! Room temperature results (T=25°C).

	No External Resistor	With External Current Adjust Resistor = 43 Ω
12 volt PCB, using BCR402W	21.1 mA	35.9 mA
24 Volt PCB, using BCR402W	21.5 mA	36.8 mA

12 Bill Of Material (BOM), +12 Volt Striplight Application Board

Reference Designator	Value	Part # / Description	Manufacturer	Function
D1	---	BAS3010A-03W Schottky Diode SOD323 package ~ 250mV voltage drop at 20mA	Infineon Technologies	Optional Reverse Polarity Protection (RPP); if RPP is not required, OMIT D1 and then INSERT R1 (Zero ohm jumper).
R1	0 ohm	'0603' case size chip resistor, zero ohms	Various	Zero ohm 'jumper'; ONLY use if D1 is NOT used.
R2	TBD	'0603' case size chip resistor	Various	OPTIONAL: only needed if desired LED current is > 20mA (when using BCR402W) or > 10mA (when BCR401W is used). Please refer to BCR401W and BCR402W datasheets for info on selection of proper resistor value for attaining a desired current. Value of R2 will be DIFFERENT when using BCR402W, then when using BCR401W).
D2, D3, D4	---	LW T6SG Series LED TOPLED long life Enhanced Optical Power Light Emitting Diode	OSRAM Opto Semiconductors	Refer to OSRAM datasheet for complete ordering code
IC1	---	BCR402W Constant-Current LED Driver IC, 20mA minimum current adjustable up to 60mA, with Negative Temperature Coefficient, 18V Max Voltage rating. (Note, BCR401W may be substituted if user desires LED current from 10 to 20mA).	Infineon Technologies	LED Driver IC
J1, J2		MTA-100 Series 3 pin connector, right angle, Part Number # 640455-3	Tyco (AMP)	3 Pin DC connector header, 2 per PC board
---		PC Board, Part # 402W-090608 Rev A	Infineon Technologies	Printed Circuit Board, +12 Volt Striplight Application

13 Bill Of Material (BOM), +24 Volt Striplight Application Board

Reference Designator	Value	Part # / Description	Manufacturer	Function
D1	---	BAT64-02W Schottky Diode SCD80 package ~ 400mV voltage drop at 20mA	Infineon Technologies	Optional Reverse Polarity Protection (RPP); if RPP is not required, OMIT D1 and then INSERT R1 (Zero ohm jumper).
R1	0 ohm	'0603' case size chip resistor, zero ohms	Various	Zero ohm 'jumper'; ONLY use if D1 is NOT used.
R2	TBD	'0603' case size chip resistor	Various	OPTIONAL: only needed if desired LED current is > 20mA (when using BCR402W) or > 10mA (when BCR401W is used). Please refer to BCR401W and BCR402W datasheets for info on selection of proper resistor value for attaining a desired current. Value of R2 will be DIFFERENT when using BCR402W, then when using BCR401W).
D2, D3, D4, D5, D6, D7	---	LW T6SG Series LED TOPLED long life Enhanced Optical Power Light Emitting Diode	OSRAM Opto Semiconductors	Refer to OSRAM datasheet for complete ordering code
IC1	---	BCR402W Constant-Current LED Driver IC, 20mA minimum current adjustable up to 60mA, with Negative Temperature Coefficient, 18V Max Voltage rating. (Note, BCR401W may be substituted if user desires LED current from 10 to 20mA).	Infineon Technologies	LED Driver IC
J1, J2		MTA-100 Series 3 pin connector, right angle, Part Number # 640455-3	Tyco (AMP)	3 Pin DC connector header, 2 per PC board
---		PC Board, Part # 402W-090611 Rev A	Infineon Technologies	Printed Circuit Board, +24 Volt Striplight Application

14 Summary and Conclusions

Using Infineon's BCR401W or BCR402W Constant Current LED Driver IC instead of Resistors for biasing LED-based Striplights offers the following advantages to the lighting systems designer:

1. **tighter control of LED current over temperature & supply voltage variations, with Negative Temperature Coefficient (NTC) of LED Driver helping prevent Thermal Runaway in LEDs**
2. **more homogeneous, consistent light output** between adjacent strings of LED's
3. **Improved LED lifetimes and reliability** arising from tighter control of LED current (and thus better control over LED junction temperatures), as well as prevention of Thermal Runaway in the LEDs.

15 References

Note – the references below are embedded into this document and may be opened from within Adobe Acrobat by double-clicking on the respective paper clip icon.

[1]. BCR401W LED Driver IC Datasheet, Infineon Technologies AG.



[2]. BCR402W LED Driver IC Datasheet, Infineon Technologies AG.



[3]. BAS3010A-03W Schottky Diode Datasheet, Infineon Technologies AG.



[4]. BAT64 Series Schottky Diode Datasheet, Infineon Technologies AG.



[5]. OSRAM Opto Semiconductors LW T6SG Light-Emitting Diode Datasheet. OSRAM Opto Semiconductors GmbH.



[6]. The embedded ZIP-format file below contains Gerber, Drill and Fabrication Drawing files for the +12 Volt Striplight Printed Circuit Board shown in this Applications Note.

[7]. The embedded ZIP-format file below contains Gerber, Drill and Fabrication Drawing files for the +24 Volt Striplight Printed Circuit Board shown in this Applications Note.

www.infineon.com