

BCR450, TDA4863

40W LED Street and Indoor lighting  
demonstrator board

Application Note AN186

Revision: 1.0

Date: 18.12.2009

[www.infineon.com/lighting](http://www.infineon.com/lighting)

**Edition 18.12.2009**

**Published by  
Infineon Technologies AG  
81726 Munich, Germany**

**© 2009 Infineon Technologies AG  
All Rights Reserved.**

#### **Legal Disclaimer**

The information given in this document shall in no event be regarded as a guarantee of conditions or characteristics. With respect to any examples or hints given herein, any typical values stated herein and/or any information regarding the application of the device, Infineon Technologies hereby disclaims any and all warranties and liabilities of any kind, including without limitation, warranties of non-infringement of intellectual property rights of any third party.

#### **Information**

For further information on technology, delivery terms and conditions and prices, please contact the nearest Infineon Technologies Office ([www.infineon.com](http://www.infineon.com)).

#### **Warnings**

Due to technical requirements, components may contain dangerous substances. For information on the types in question, please contact the nearest Infineon Technologies Office.

Infineon Technologies components may be used in life-support devices or systems only with the express written approval of Infineon Technologies, if a failure of such components can reasonably be expected to cause the failure of that life-support device or system or to affect the safety or effectiveness of that device or system. Life support devices or systems are intended to be implanted in the human body or to support and/or maintain and sustain and/or protect human life. If they fail, it is reasonable to assume that the health of the user or other persons may be endangered.



---

Application Note AN186

Revision History: 18.12.2009

---

Previous Revision: Previous\_Revision\_Number

Page	Subjects (major changes since last revision)

## Content - AN186

1	Demonstrator board description .....	5
2	Key parameters .....	5
3	Advantages of this solution .....	6
4	Demonstrator board functionality .....	6
5	LED Section .....	7
6	Demonstrator board measurements and characteristics .....	8
7	BCR450 - Linear LED driver for high current LED driving.....	12
8	BCR450 LED strip application schematic.....	15

## Appendix - Application Note EVALLED-TDA4863G-40W

Single Stage High PF Flyback Converter for Offline LED Supply

2	Evaluation Board.....	17
3	List of Features.....	17
4	Technical Specification.....	18
5	Operation.....	18
5.1	Basic Operation.....	18
5.2	Output Control .....	19
6	Setup and Results.....	19
6.1	Input/ Output Connector description.....	19
6.1.1	J1 – Vin.....	20
6.1.2	VCC.....	20
6.1.3	GND.....	20
6.1.4	REFGND.....	20
6.2	Setup.....	20
6.3	Power Up.....	20
6.4	Output Ripple.....	21
6.5	Efficiency.....	21
6.6	Power Factor Correction.....	22
6.7	EMI.....	24
7	Board Layout.....	25
8	Schematic and BOM.....	27
8.1	Schematic.....	27
8.2	Bill of Materials.....	28
8.3	Transformer.....	29
	References.....	30

## 1 Demonstrator board description

This demo board shows a 40W offline AC-to-DC LED driving solution with power factor correction. The isolated concept ensures easy and safe installation and maintenance for street lights and Indoor lighting fixtures.

The design utilizes a three step approach with a universal input PFC IC stage on the primary side, a current and voltage controller IC to set the DC voltage required for the LED strings and a linear LED driver IC in combination with an external booster transistor for each string to supply the LEDs with constant current.

Dimming of the LEDs is possible via applying a PWM signal to a dedicated pin of the LED strings, which controls the output current.

The modular concept allows extending the number of LED strings attached to the secondary side to realize street lighting designs with higher output power.

In case of higher output power the primary side has to be modified to improve PF correction, as the power factor correction is optimized to 40W output power.

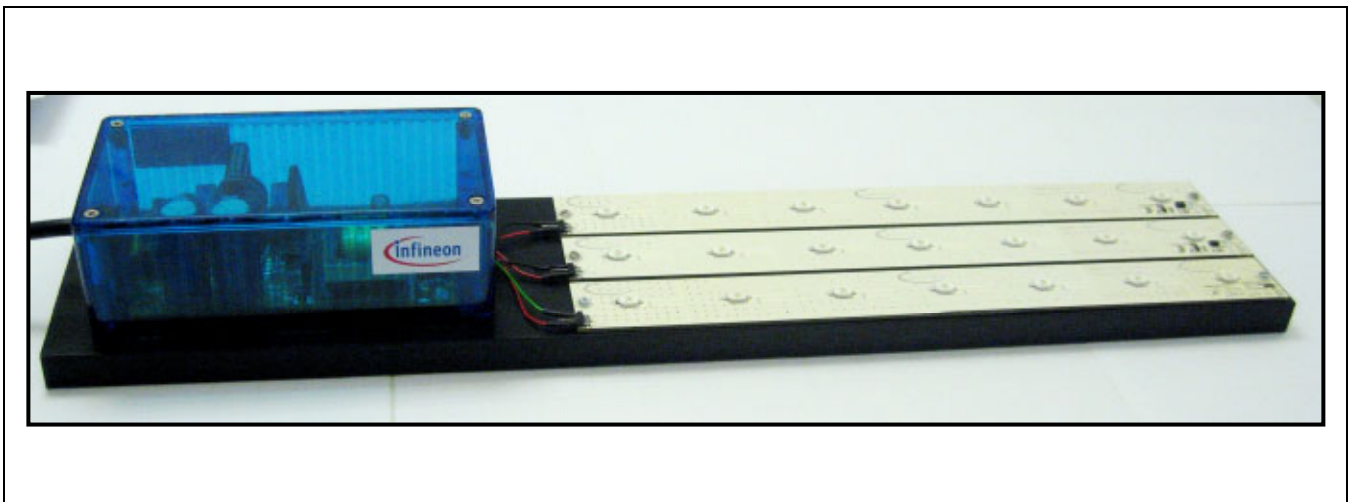

**Figure 1** 40W LED Street and Indoor lighting board picture

## 2 Key parameters

Supply voltage:	90-270VAC
Output voltage on secondary side:	~23VDC
Output current:	350mA
LED type:	OSRAM Golden Dragon Plus
Efficiency:	up to 87%
Power Factor:	> 0.90

### 3 Advantages of this solution

- Cost competitive due to low-cost IC approach
- Low part count on primary and secondary side
- Low EMI due to linear driving concept on the secondary side
- Easy to implement and maintain

### 4 Demonstrator board functionality

The TDA4863 is used as a flyback controller and power factor correction in a single stage. On the secondary side the voltage regulator – TLE4305 provides constant-current, constant-voltage feedback to the TDA4863 via an optocoupler.

The TLE4305 sets the required voltage for the LED strings through a reference string: The sum of the forward voltage  $V_f$  of the LED's in the reference string plus a resistor, that simulates the voltage drop at the linear LED driver IC, and provides exactly this voltage to all LED strings. Figure 2 shows the basic application schematic of this demo board.

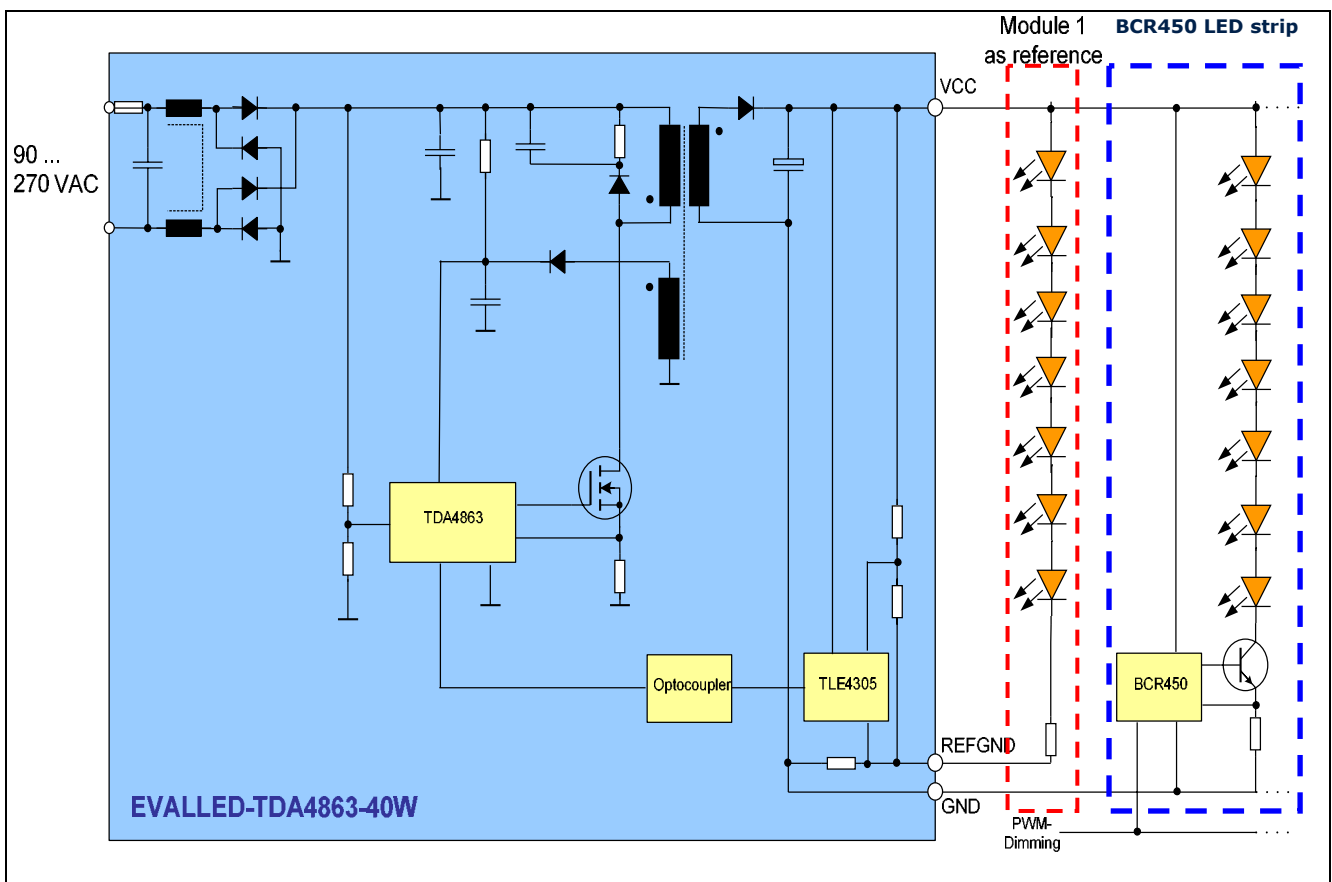

Figure 2 Basic Application Schematic

Except for the reference string, all LEDs are driven by the linear LED driver BCR450 with the external booster transistor BCX68-25. This circuitry enables to use a high featured and low cost linear LED driver like BCR450 very efficiently.

## 5 LED Section

### 5.1 $V_f$ LED forward voltage

A different LED forward voltage value  $V_f$  than the above mentioned 3.2V will have no impact on the system, as long as all LEDs used in the system are from the same batch, thus having the same  $V_f$ . If the sum of  $V_f$  in the reference string is lower than  $V_f$  in the BCR450 strings, the system will not work.

In case different forward voltages one must take care that the sum of  $V_f$  in the reference string is equal or higher than the sum of  $V_f$  in the following parallel BCR450 strings.

A short calculation example:

The reference string uses 7 LEDs with a  $V_f$  of 3.2V. The resistor simulates a voltage drop of 1.0V → The TLE4305 sets the voltage to  $7 \times 3.2V + 1.0V = \mathbf{23.4V}$

In the following BCR450 LED strings  $V_f$  is lower, for example 3.0V. The BCR450 + BCX68-25 have a voltage drop of 0.5V.

→  $7 \times 3.0V + 0.5V = \mathbf{21.5V}$

This means 0,67W ( $1.9V \times 350mA$ ) will be dissipated at the external transistor BCX68-25. The 0.67W power dissipation are in spec, as the BCX68-25 is designed for a maximum power dissipation of 3W,

More details on choosing the external transistor can be found in section **6.3 The BCR450 high current concept**.

### 5.2 Choosing lower- or higher-power LEDs

This demo board uses OSRAM Golden Dragon Plus, driven at 350mA which represents the typical drive current for 1W LEDs. It is possible to choose LEDs with lower currents (e.g. 0.5W LEDs with 150mA) or LEDs with higher currents (e.g. 3W LEDs with 700mA).

This requires a change on the BCR450 LED strip circuit:

The changes to be made are described in Application Note **AN105**, section: 4.1. *Calculation of the base voltage divider*, which can be found in the application document section at [www.infineon.com/lowcostleddriver](http://www.infineon.com/lowcostleddriver) or via direct link: [AN105](#)

### 5.3 Dimming of the LEDs in the strings

Dimming of the LEDs in the BCR450 LED strings is possible by applying a PWM signal, e.g. from a microcontroller. The BCR450 has a digital input pin that is able to process PWM signals with a frequency of up to 200Hz.

Dimming of the first string, the reference string, is not possible as the TLE4305 regulates voltage and current, and will react to the change in current by a PWM signal.

## 6 Demonstrator board measurements and characteristics

### 6.1 Efficiency

This diagram shows the AC to DC conversion efficiency, as well as the BCR450 LED strip efficiency on the DC side. The combination of both results in the overall efficiency from the main to the LEDs.

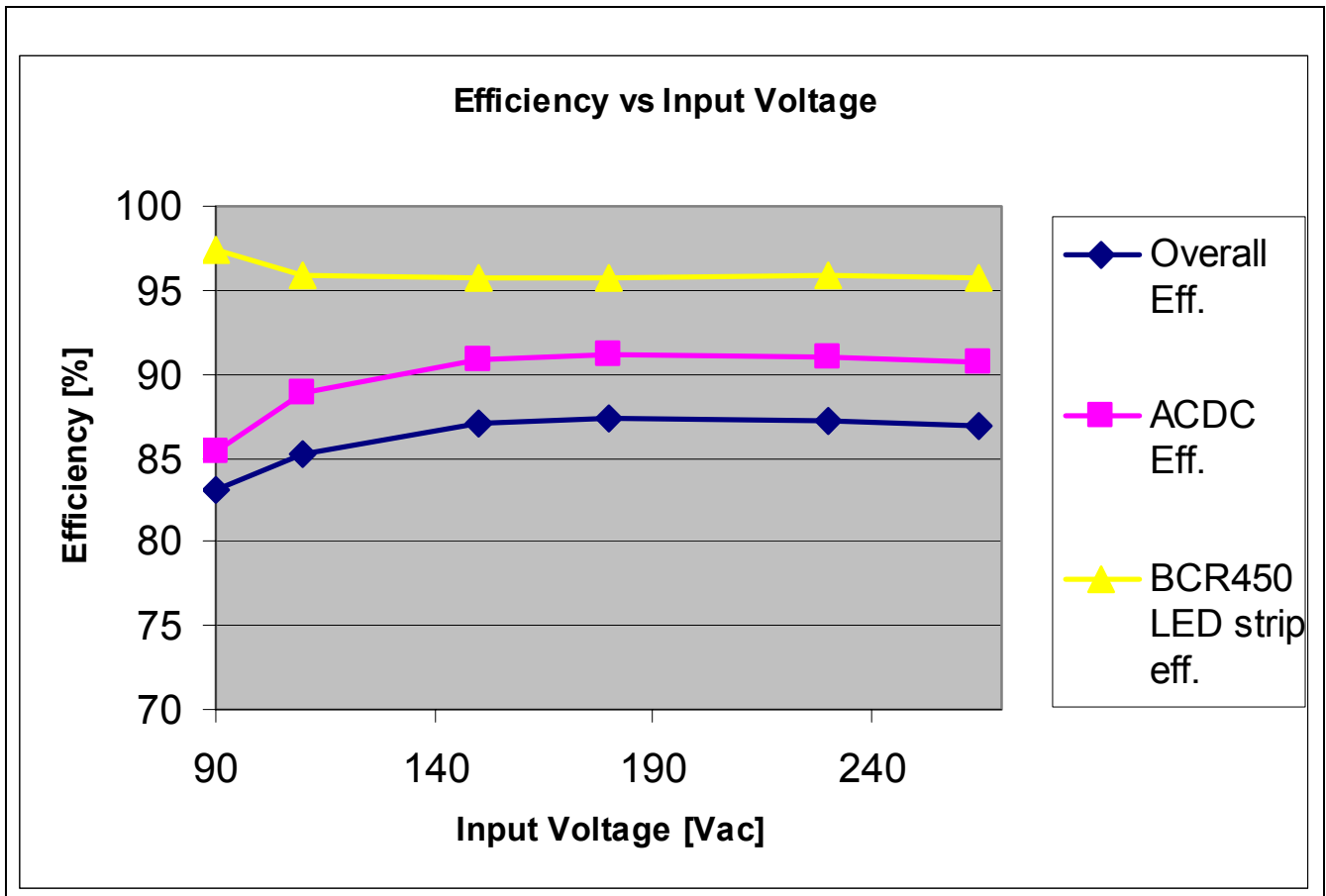

Figure 3 Efficiency vs. Input voltage at 20W output power

As shown in figure 3, the AC-DC conversion efficiency is at 91% at 230V AC for 20W output power.

Efficiency of the BCR450 LED strings: constant at 96%.

Multiplication of these 2 values leads to the overall system efficiency for 230V: 87%

Overall system efficiency with 110V supply voltage is 85%.



## 6.2 Power factor

Figure 4 shows the difference between an AC-DC supply with and without a power factor correction.

Without power factor correction the input current flow occurs only in short spikes at the minimum and maximum input voltages. This leads to high disturbances and high reactive power in the power grid.

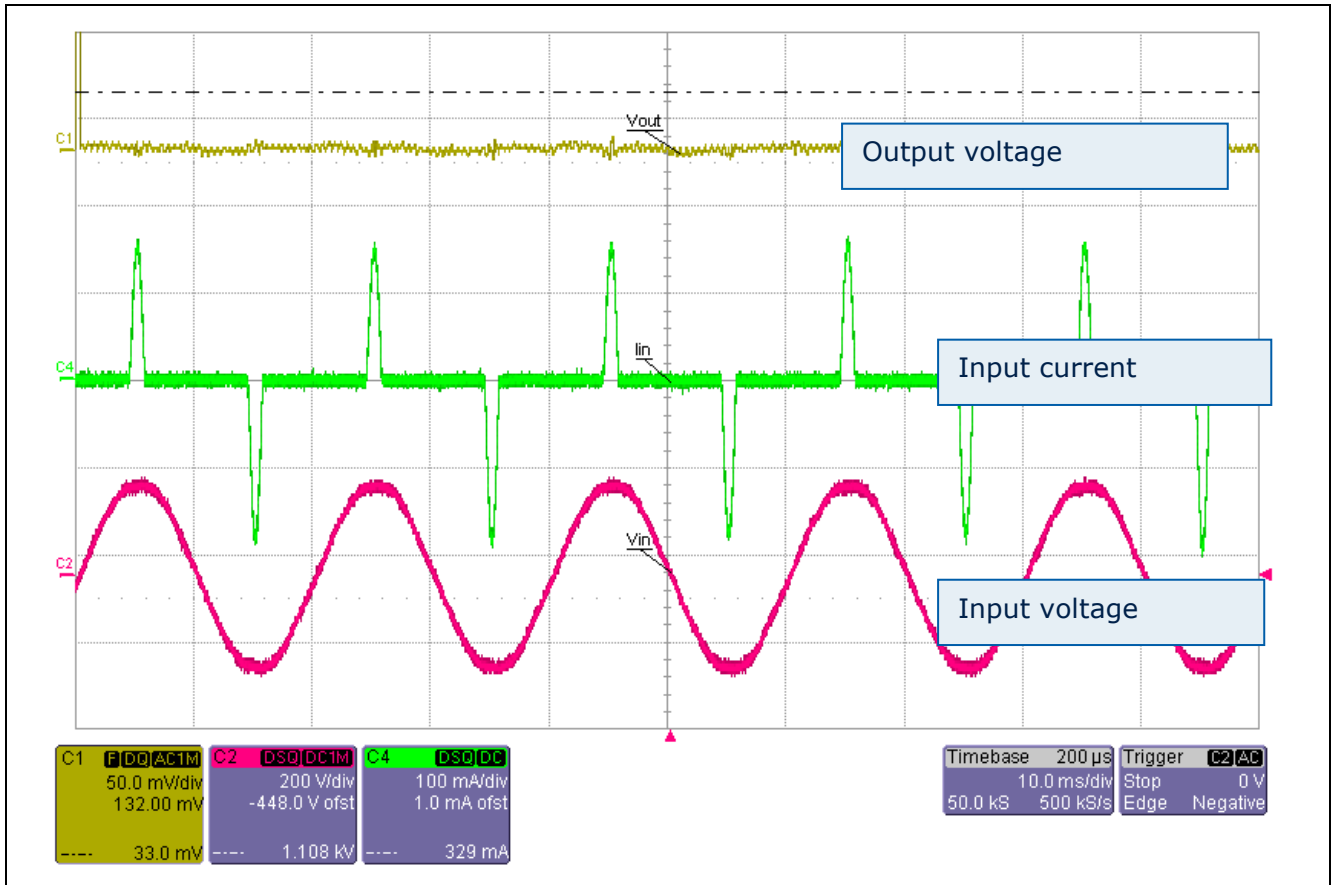

Figure 4 AC-DC supply without power factor correction

In figure 5 the AC-DC supply is equipped with a power factor correction and as a result the current is shaped like the input voltage.

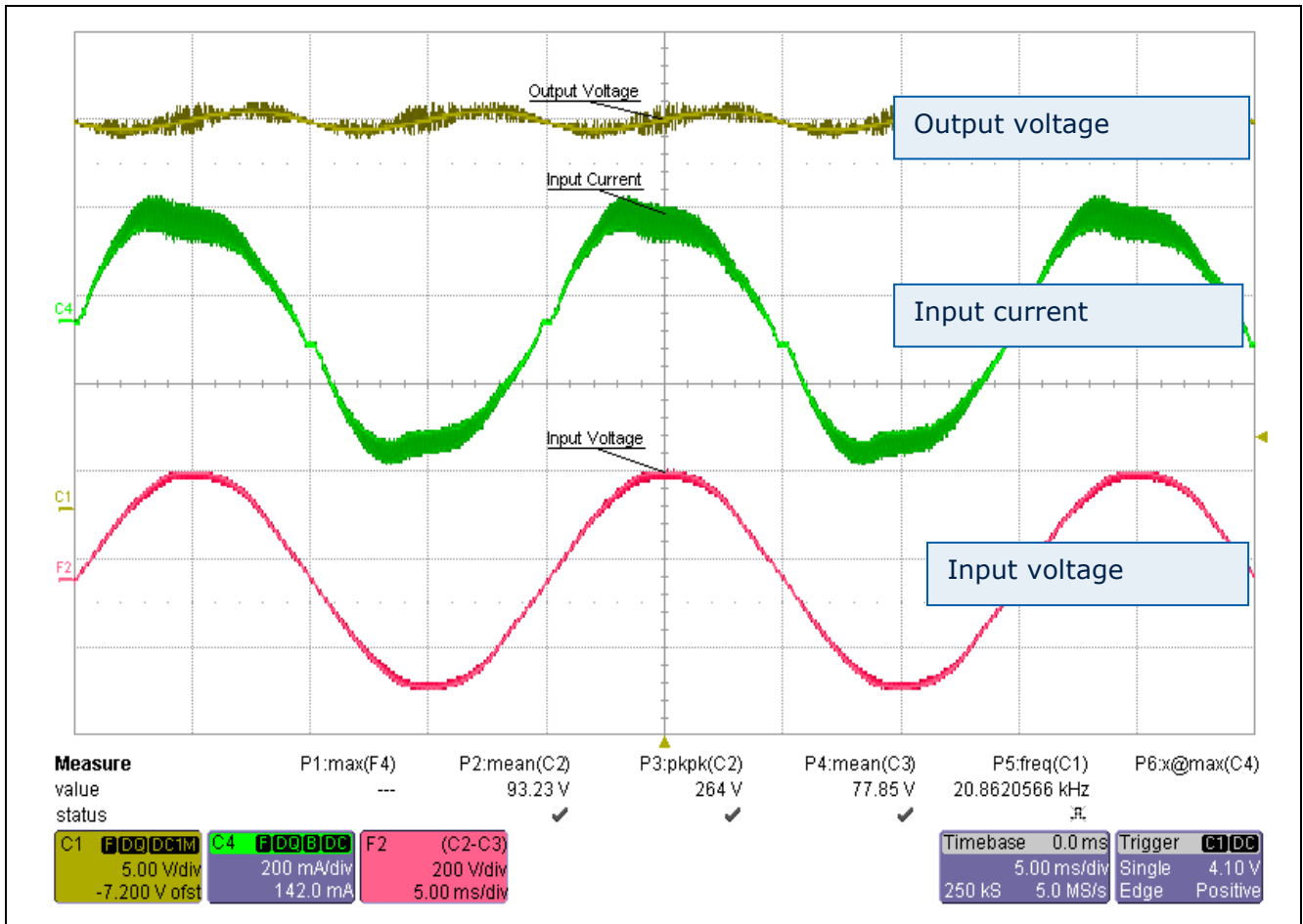

Figure 5 AC-DC supply with power factor correction

The operation principle allows for a very good power factor, which is mostly limited by the input filter.

Figure 6 shows the actual input voltage and current waveforms of the 40W demo board, the power factor and the harmonic distortion for 230V AC input voltage. Figure 7 shows the actual power factor of the demo board as function of input voltage and output power.

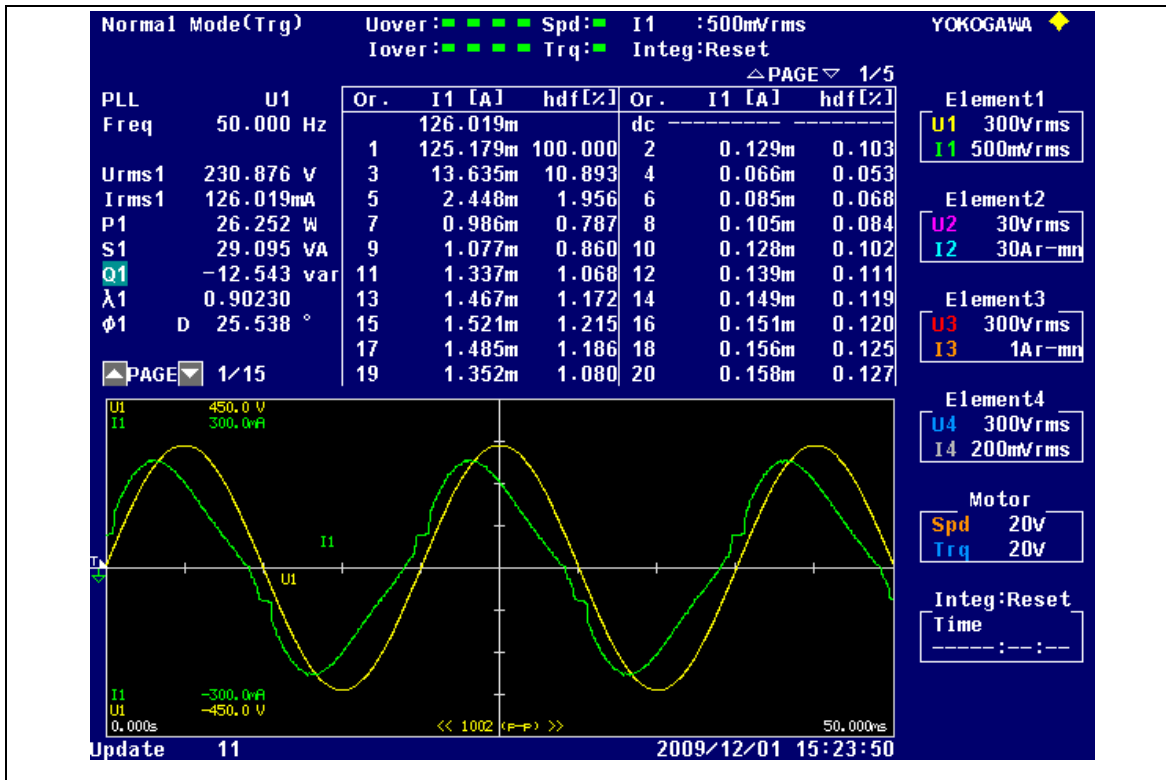

Figure 6 Actual Input voltage, current waveform, power factor, harmonic distortion

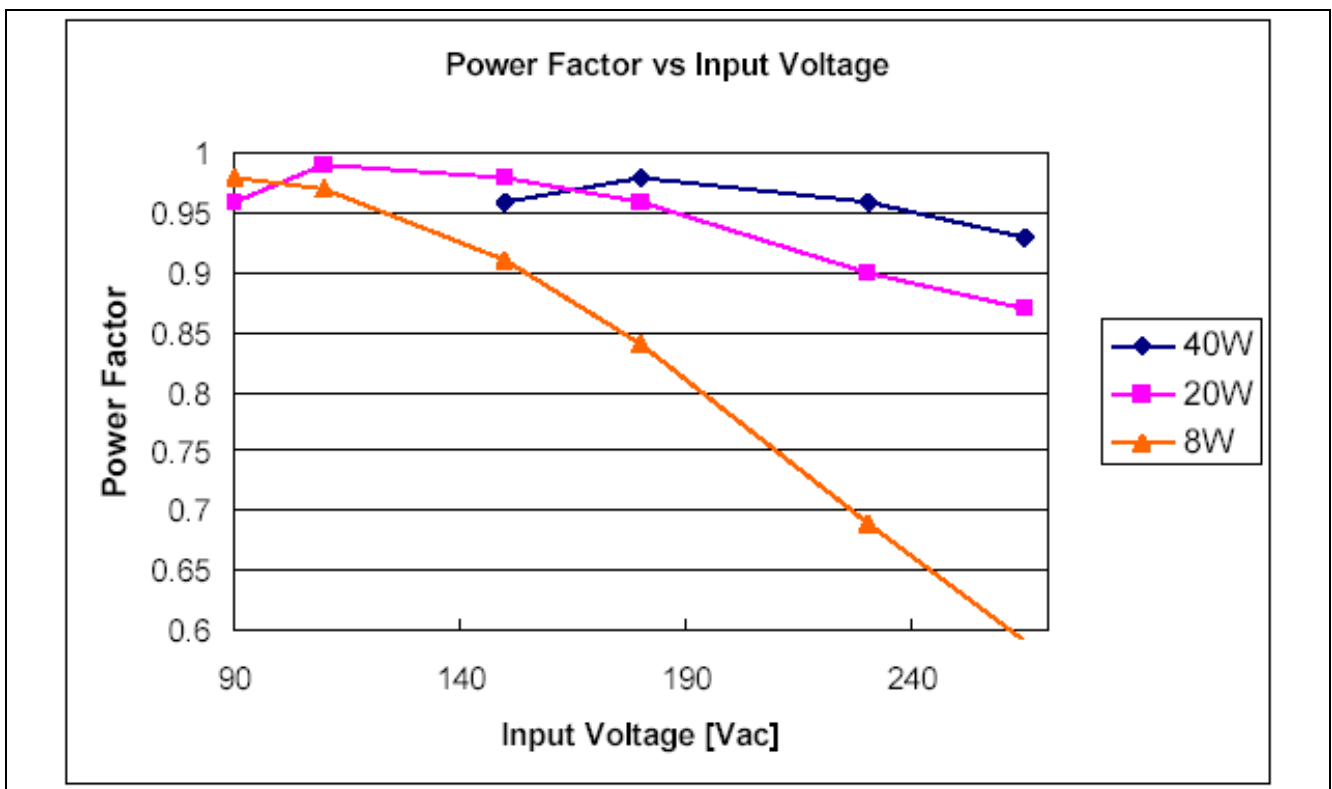

Figure 7 Power factor vs. Input voltage over output power of the demo board

## 7 BCR450 - Linear LED driver for high current LED driving

### 7.1 BCR450 facts, features, benefits

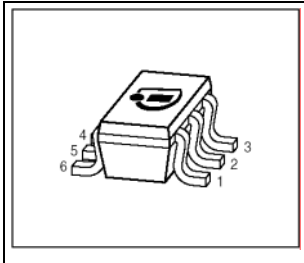

Figure 8 BCR450 in SC-74 package

The BCR450, with features like high output current accuracy of +/- 1.5%, overcurrent and overvoltage protection and the ability to protect the LEDs from thermal overstress, is designed for high current general lighting applications.

The 85mA current in standalone mode can be extended to up to 2.0A with an external booster transistor. This circuit for high current applications is described in Application Note AN105.

The combination of protection features and a price performance ratio that is benchmark in the industry, the BCR450 offers a unique, yet cost effective way to drive high power LEDs.

#### Features of the BCR450:

- High output current precision of +/- 1.5% at 25°C
- Current range:
  - Standalone mode: up to 85mA
  - Booster circuit: 85mA – 2000mA
- Maximum operating voltage: 27V
- Overvoltage and overcurrent protection
- Thermal shutdown
- Low voltage overhead in boost mode  
of only 0.5V (0.15V at sense resistor + 0.35V at booster transistor)
- Direct PWM possible due to logic level enable input
- Small 6-pin SC74 package

#### Benefits of the BCR450:

- Thermal shutdown protects the LEDs from permanent damage
- Linear concept eliminates EMI problems
- External power stage allows improved heat dissipation in comparison to monolithic drivers
- Higher count of LEDs possible in a string due to very low voltage overhead
- Less space needed on PCB, as no coils and inductors are required and no external digital transistor for PWM
- Excellent price-performance ratio, due to separation of power stage from higher-cost IC technology

## 7.2 The BCR450 high current concept

To extend the current range of the BCR450 to current levels beyond 85mA, another approach is needed, to reach the 350mA required current for the used OSRAM Golden Dragon + series LEDs for such higher power applications, **the LED driver is used as a “controller” and an external “boost transistor” is employed to handle the higher current and heat dissipation.**

For the correct choice of the transistor, the power dissipation and maximum ratings of the devices must be checked and verified for each individual circuit design. As a general guideline, the **BC817SU** is recommended for ½ Watt LEDs with currents up to 150mA, the **BCX68-25** is recommended for 1W LEDs with current up to 350mA and the **BDP947** for higher power, mostly 3W LEDs with current levels above 350mA, up to 700mA. In general, the upper limit on output current for this circuit is only limited by the maximum power dissipation & junction temperature of the boost transistor. It is even possible to parallel multiple boost transistors for extremely high current operation.

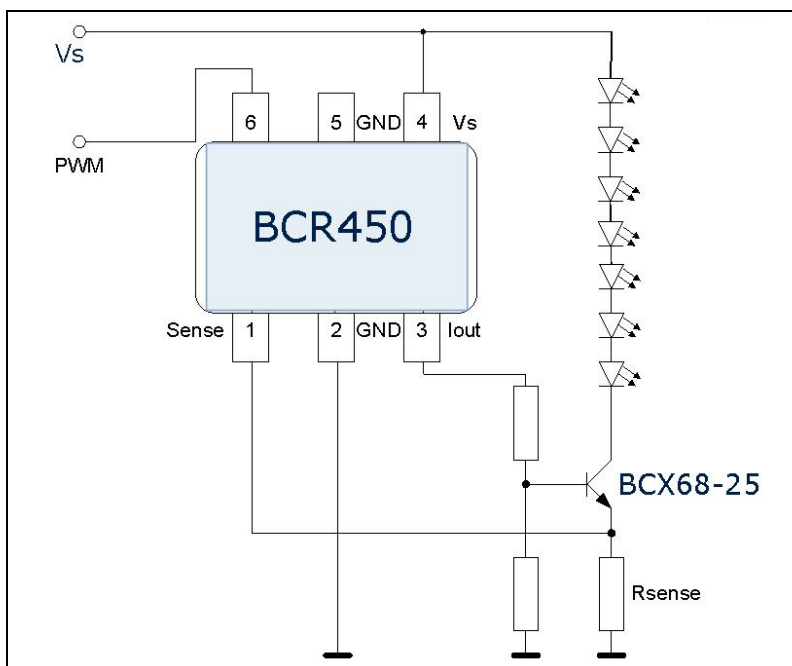

Figure 9 BCR450 in a high current circuit for LED driving

In this particular case, the **BCX68-25** was chosen, as the LED current is commonly 350mA for 1W LEDs.

In this approach, the LED driver IC and external boost transistor still operate in a closed-loop system and therefore the LED current is still tightly controlled over temperature and power supply voltage variations. The basic concept is simple: the LED driver takes its output current and feeds it into the base terminal of the external NPN boost transistor, in this case the BCX68-25.

The boost transistor then multiplies this base current by the DC current gain (hFE) of the boost transistor, with a much higher output current at the collector. The collector current supplies the 3 LEDs in series.

Since the required output current from the standard LED driver is reduced or divided by the DC current gain of the boost transistor, most of the power dissipation burden is now placed upon the boost transistor, instead of on the LED Driver IC. The advantages of the low-current, stand-alone BCR450 LED Driver circuit – including the high current precision of +/- 1,5%, the thermal shutdown feature which protects the LEDs from damage and the overcurrent and overvoltage protection- are preserved.



## **Appendix - Application Note EVALLED-TDA4863G-40W**

Single Stage High PF Flyback Converter for Offline LED Supply

To give a more detailed view on the switch-mode power supply part, hence the AC-DC conversion of the demonstrator board, the following section focuses on this part. This part is also available as a separate application note on [www.infineon.com](http://www.infineon.com)



## 1 Content

The EVALLED-TDA4863G-40W is a demoboard to demonstrate the concept of a single stage PFC+Flyback converter using the TDA4863G and the CC-CV control chip TLE4305G in a LED driving application.

## 2 Evaluation Board

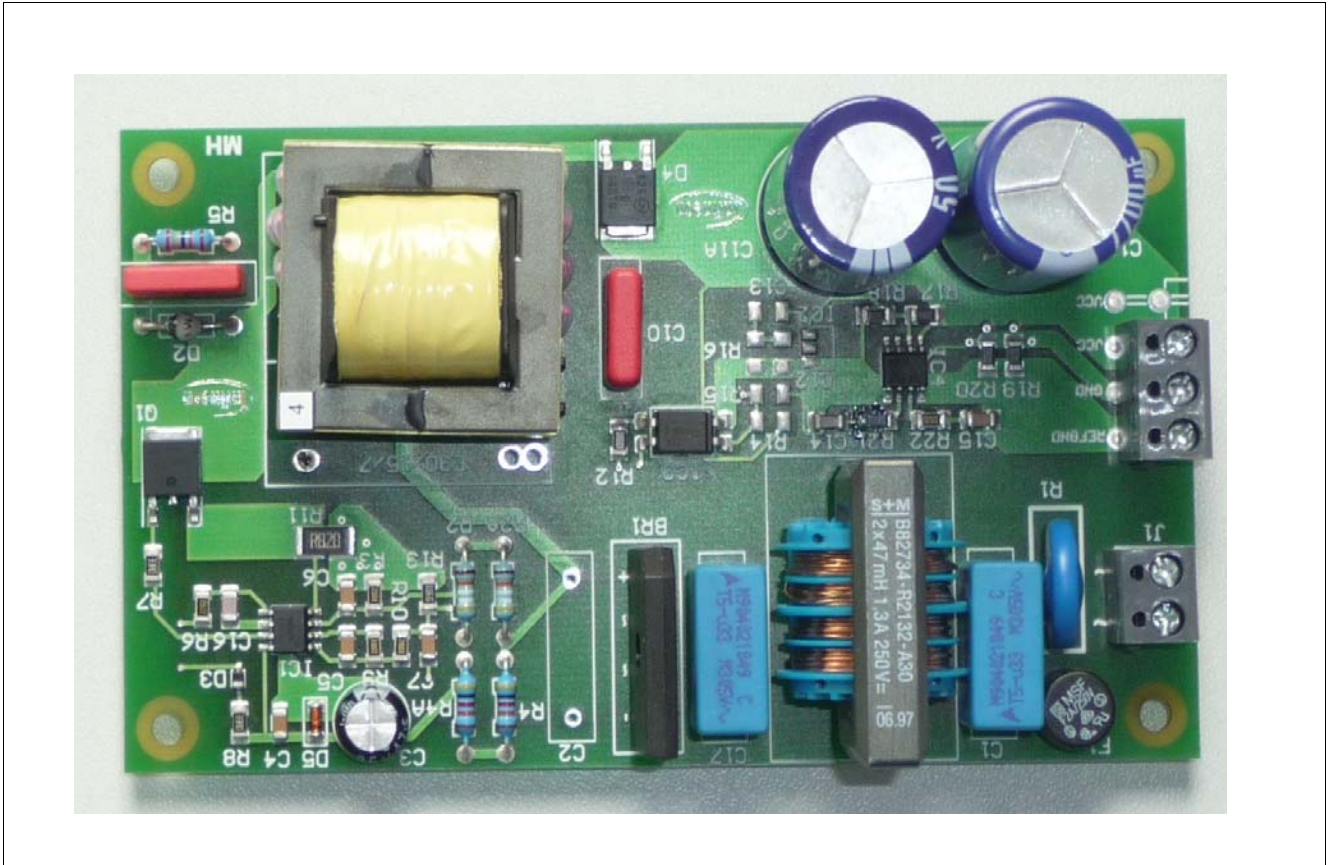

**Figure 2-1 EVALLED-TDA4863G-40W**

## 3 List of Features

- High Efficiency of ~90%
- High Power Factor up to 0.98 and low THD
- Low System BOM, through Single Stage Concept
- +/- 2% Accuracy Constant-Current Constant-Voltage Regulation
- Cycle-By-Cycle Peak Current Limitation
- Low In-Rush Current
- VCC Over and Under-Voltage Protection

## 4 Technical Specification

**Table 4-1** provides a summary of the EVALLED-TDA4863G-40W performance specification.

**Table 4-1 Performance Specification**

Specification	Min	Typ	Max	Unit
Input Voltage	180	230 <sup>1)</sup>	270	AC V
Output Voltage	15	22	26	V
Output Current	-2%		+2%	mA
Output Power			40	W
Output Ripple		+/-15%		A

1) for a maximum output power of 20W the input voltage range is universal (90 V - 270 V)

## 5 Operation

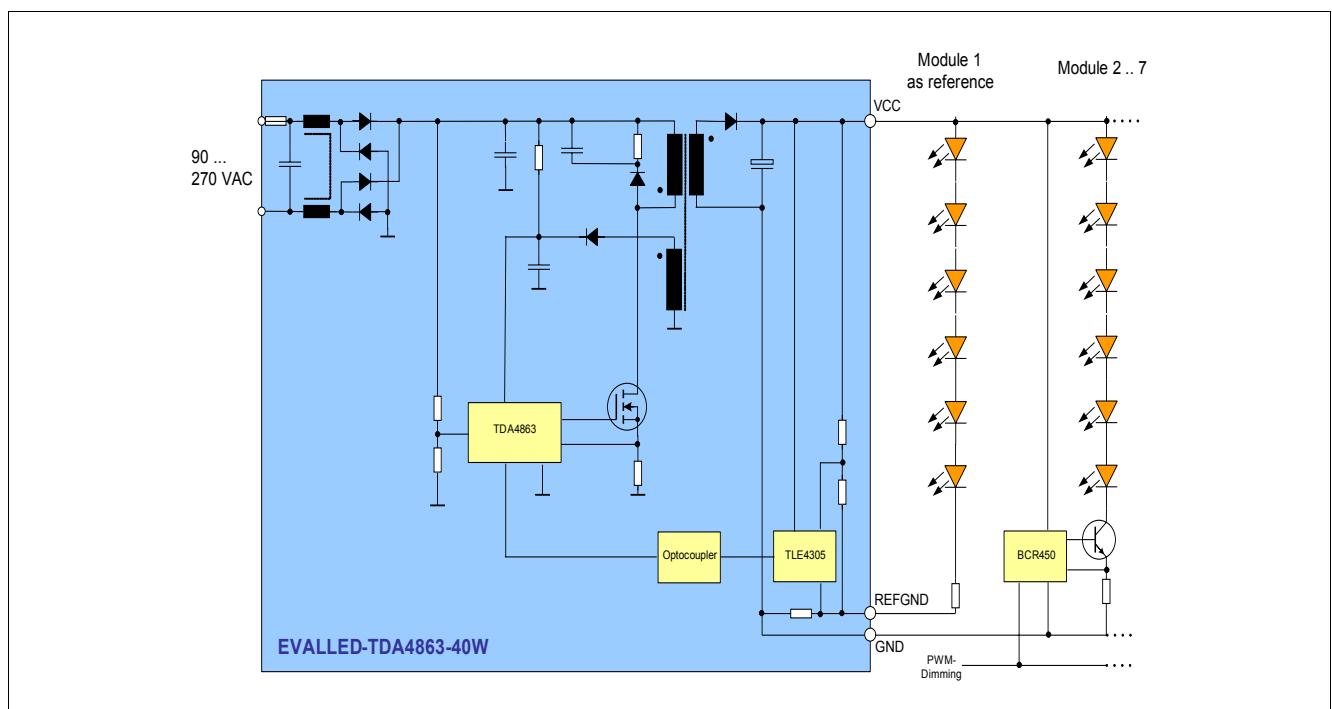

**Figure 5-1 Basic Application Schematic**

### 5.1 Basic Operation

The topology of the EVALLED-TDA4863G-40W is in principal a peak-current mode, quasi-resonant flyback converter. The current on the primary side is sensed via the sense resistor (R11). If this current reaches the threshold (I<sub>pk</sub>), the main switch (MOSFET Q1) is turned off. Zero current detection is done via the auxiliary winding of the transformer. If zero current on the secondary winding of the transformer is detected the main switch is turned on. **Figure 5-2** shows the switching waveforms. The blue curve is the voltage on the sense resistor and red curve the source-drain voltage at the main switch. This auxiliary winding is also used to supply the controller. For detailed information on the dimensioning of the transformer, sense resistor and snubber circuit see also **[3]**.

To achieve a high power factor the peak current (I<sub>pk</sub>) is modulated in a way to follow the rectified mains input voltage. The input voltage is sensed via a resistive divider (R2, R2A, R3) and this signal is multiplied with the

feedback signal via the multiplier in the TDA4863G ([1]). This modulation of the peak current modulates the input current to follow the input voltage and allows for a very good power factor. Please see Chapter 6.6 for measurement result of the power factor and harmonic distortion.

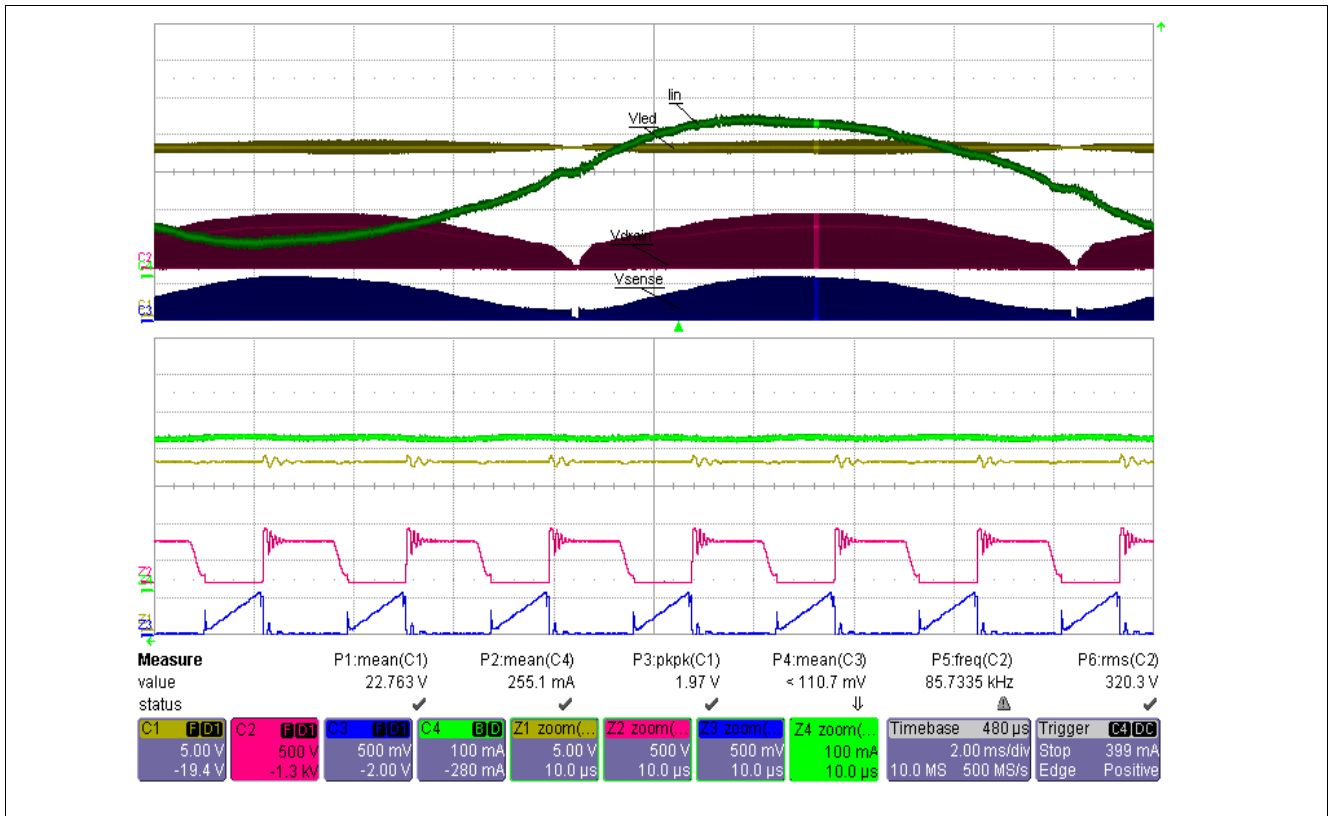

Figure 5-2 Typical switching waveforms at 230 Vac mains voltage: Input Current (green), Output Voltage

## 5.2 Output Control

The EVALLED-TDA4863G-40W allows for constant-current output control. For this control the TLE4305G is used on the secondary side to measure the output current and feedback the control signal via the optocoupler. The current is measured via the sense resistor (R19,R20) on the secondary site. To minimize the losses in the sense resistor, the TLE4305G allows for a very low sense voltage of 0.2 V. Additionally the TLE4305G measures the output voltage and switches to a constant-voltage regulation in case the output voltage exceeds the limit set by the resistive divider (R17,R18). The time constants for the cc and cv regulation loop can be set independently with the capacitors (C14,C15) and the resistors (R21,R22).

It is necessary that the current regulation time constant is lower than the mains AC frequency. On the other side the voltage regulation must be fast, to avoid an overshoot at startup.

The current regulation is set for 350mA. This is true for a load connected between VCC and REFGND. Additional LED strips can be connected between VCC and GND. These additional loads are not seen by the current regulator.

## 6 Setup and Results

## 6.1 Input / Output Connector description

### 6.1.1 J1 - Vin

Input connector for AC supply. Please see [Table 4-1](#) for the maximum input voltage.

### 6.1.2 VCC

VCC is the positive output connector.

### 6.1.3 GND

GND is the negative output connector. Connect all load to this connector which should **not** be current regulated.

### 6.1.4 REFGND

REFGND is the negative output connector. The load which is connected between VCC and REFGND is monitored and controlled to allow constant current.

## 6.2 Setup

For operation of the board connect the connector J1 to an AC voltage (see [Table 4-1](#) for input voltage range). Please be aware that high voltages of up to 800 V will be accessible on the board.

## 6.3 Power Up

The EVALLED-TDA4863G-40W utilizes a startup resistor (see R4, R4A in [Figure 8-1](#)) for the first system startup (see [Figure 6-1](#)). As soon as the VCC voltage at the TDA4863G reaches the threshold it starts operating. The start-up time is ~2 seconds. To reduce the start-up time a smaller startup resistor can be chosen. Be aware, that this will have a negative impact on the efficiency.

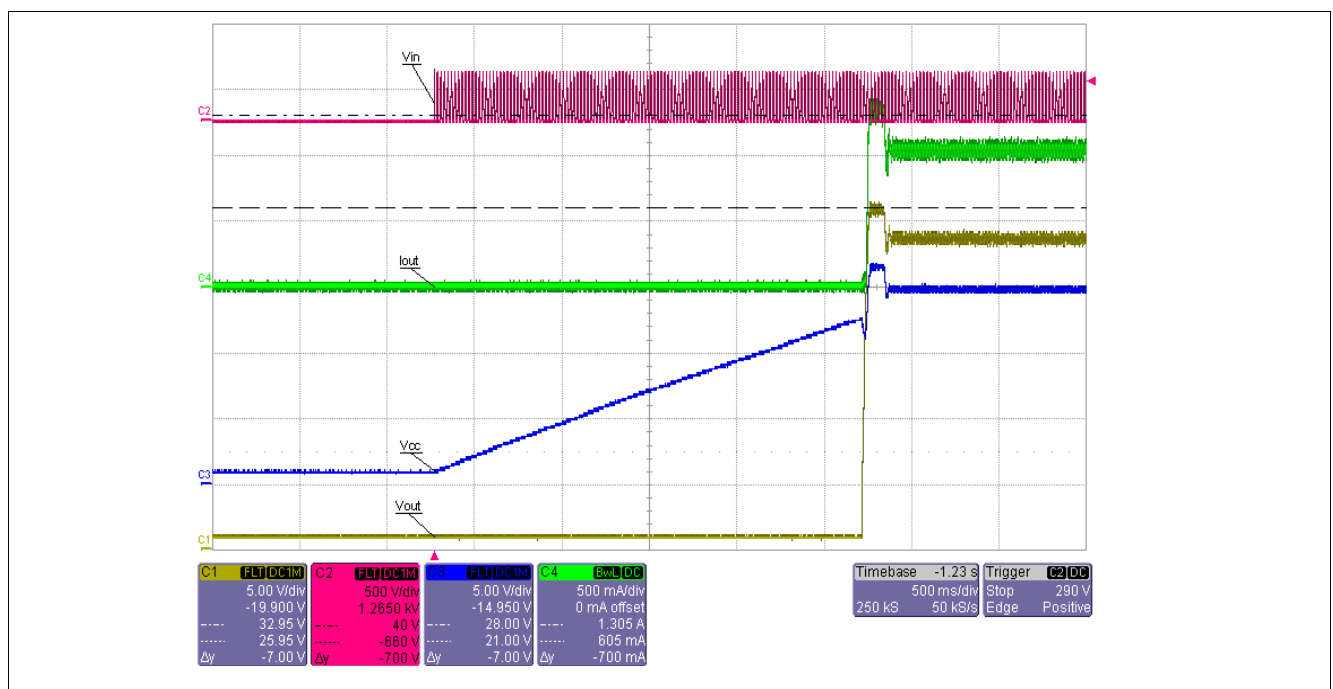

**Figure 6-1 Startup: Mains Input Voltage (red), VCC at controller (blue), Output Current (green), and Output Voltage (yellow)**

As already noted in [Chapter 5.2](#) there two different time constants for the current regulation and the voltage regulation. This can be seen in [Figure 6-2](#). During startup the output voltage rises till it is limited by the constant voltage regulation of the TLE4305G with a small time constant. After ~100ms the constant current regulation which has a much higher time constant takes over and the output current is regulated.

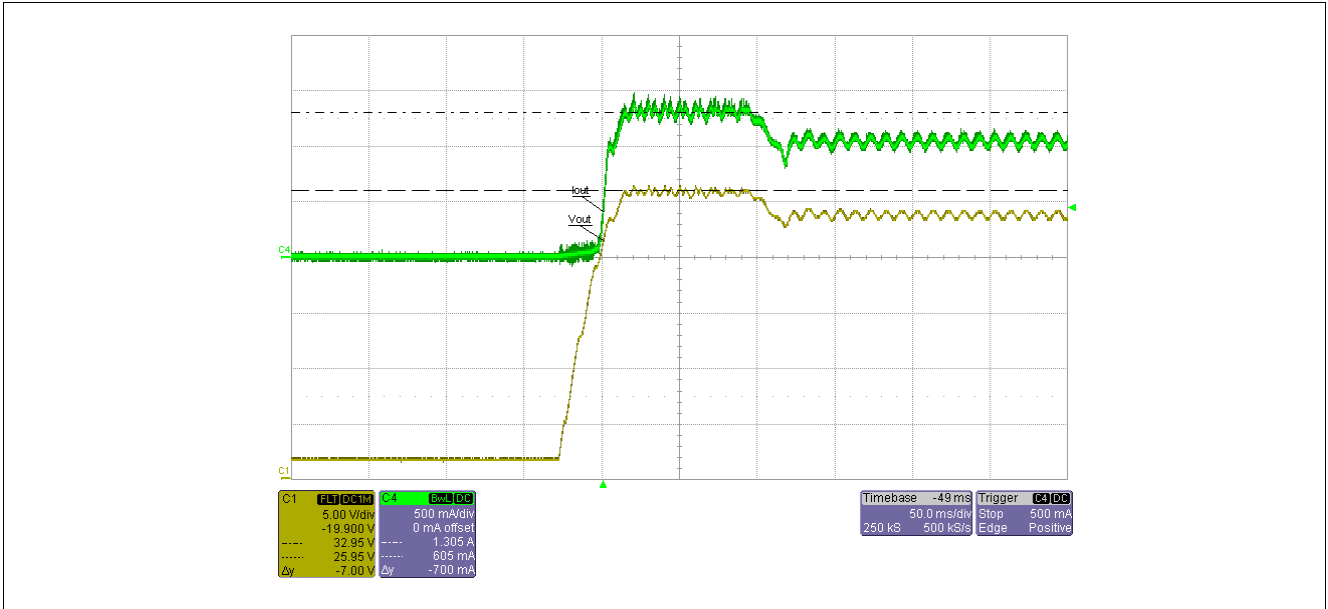

Figure 6-2 Startup: Output Current (green), and Output Voltage (yellow)

## 6.4 Output Ripple

In this topology the mains AC frequency is filtered on the secondary side of the flyback converter. This allows for a design with no high voltage electrolytic capacitors. The 100Hz/120Hz ripple of the output current is a function of the output power and the output capacitor (C11A, C11B). For 40W output power the ripple is +-15%

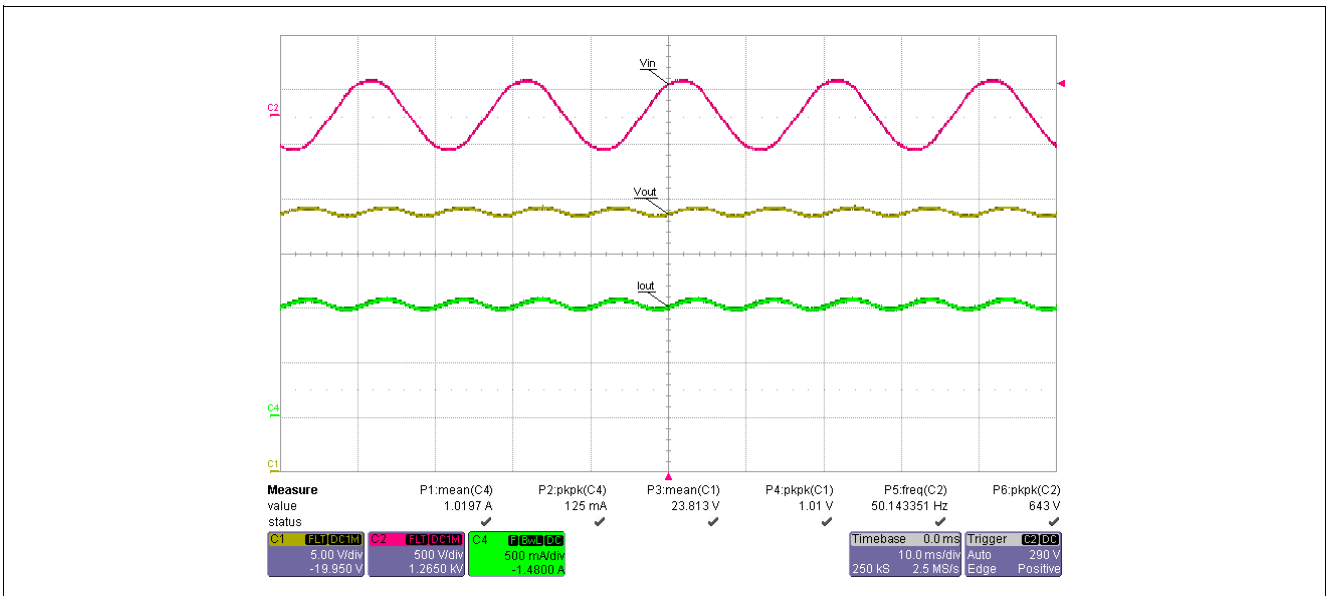

Figure 6-3 Typical Waveforms: Input Voltage (red), Output Current (green) and Output Voltage (yellow)

### 6.5 Efficiency

The principle of a quasi-resonant flyback converter allows for a good efficiency of ~90%. **Figure 6.5** shows the efficiency as function of input voltage for different output power levels.

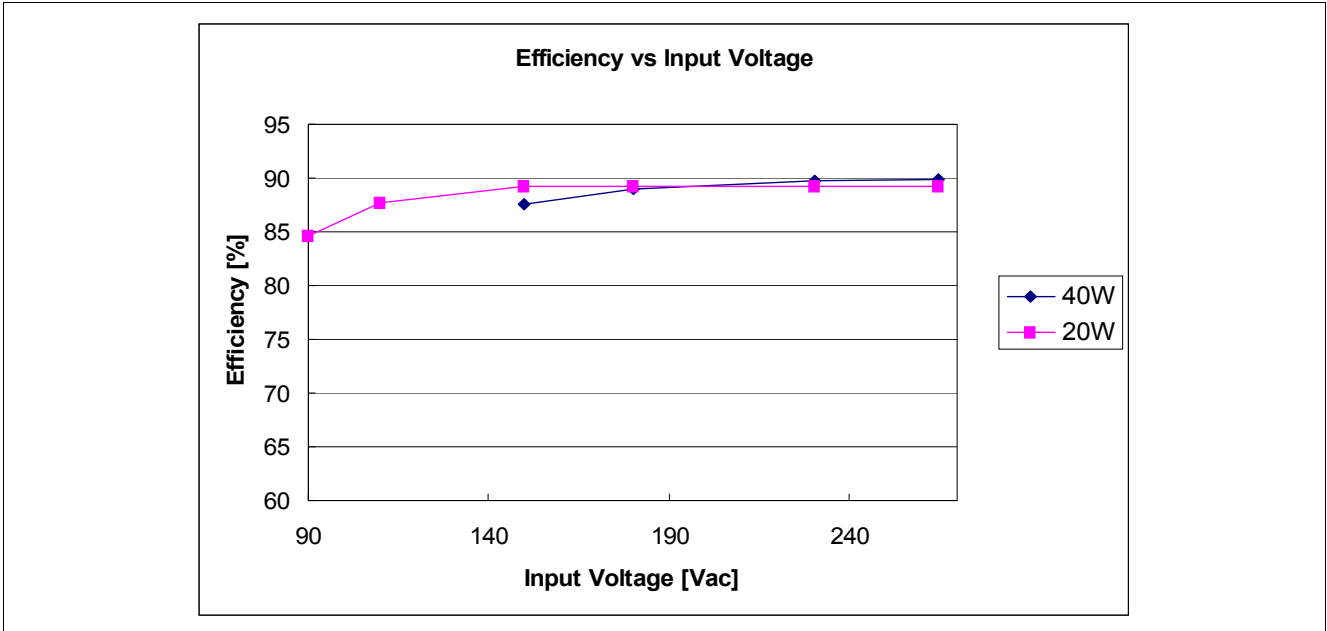

Figure 6-4 Efficiency over input voltage

### 6.6 Power Factor Correction

As discussed in **Chapter 5.1** the operation principle allows for a very good power factor, which is mostly limited by the input filter. **Figure 6-5** and **Figure 6-6** show the input voltage and current waveforms, the power factor and the harmonic distortion for 110 V and 230 V AC input voltage respectively. **Figure 6-7** shows the power factor as function of input voltage and output power.

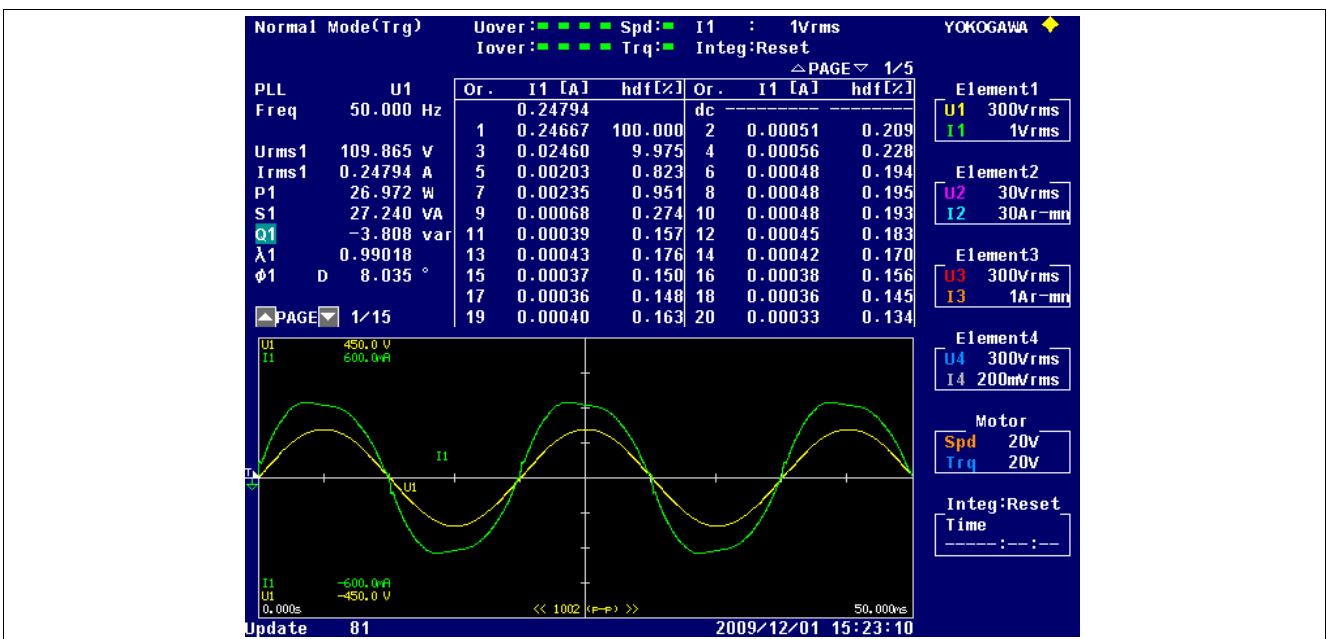

Figure 6-5 Power Factor and THD at 110 Vac input voltage and 25W output power

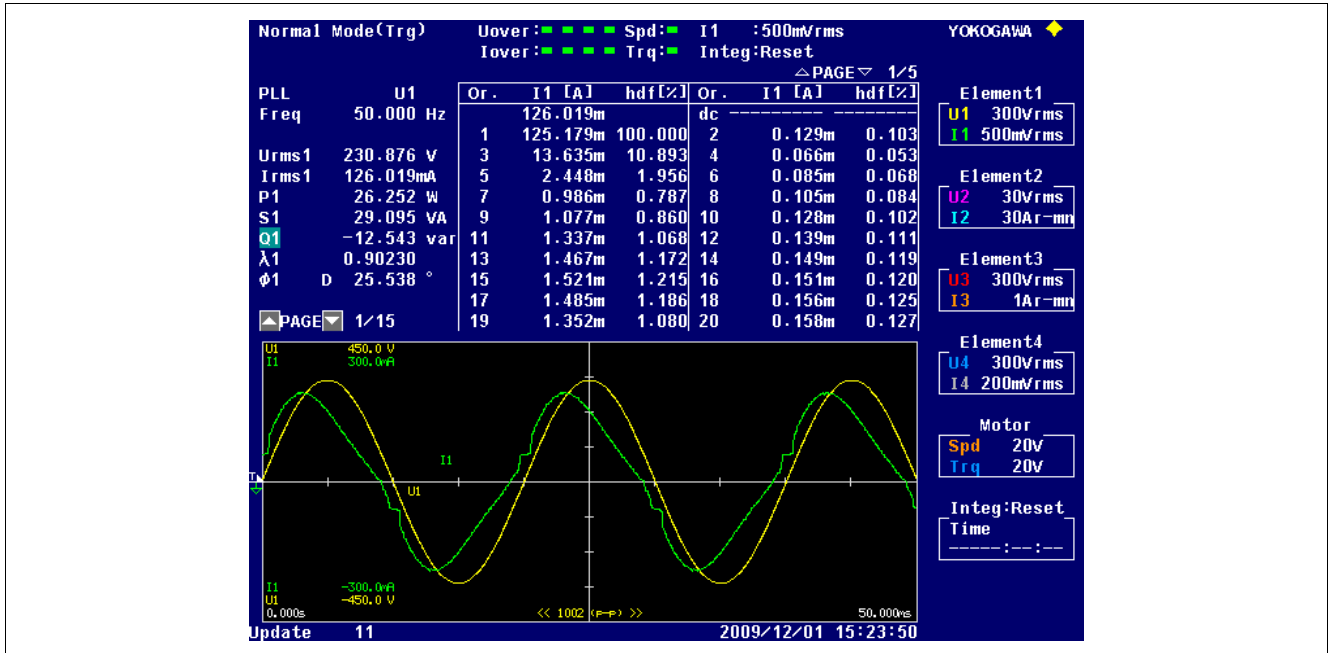

Figure 6-6 Power Factor and THD at 230 Vac input voltage and 25W output power

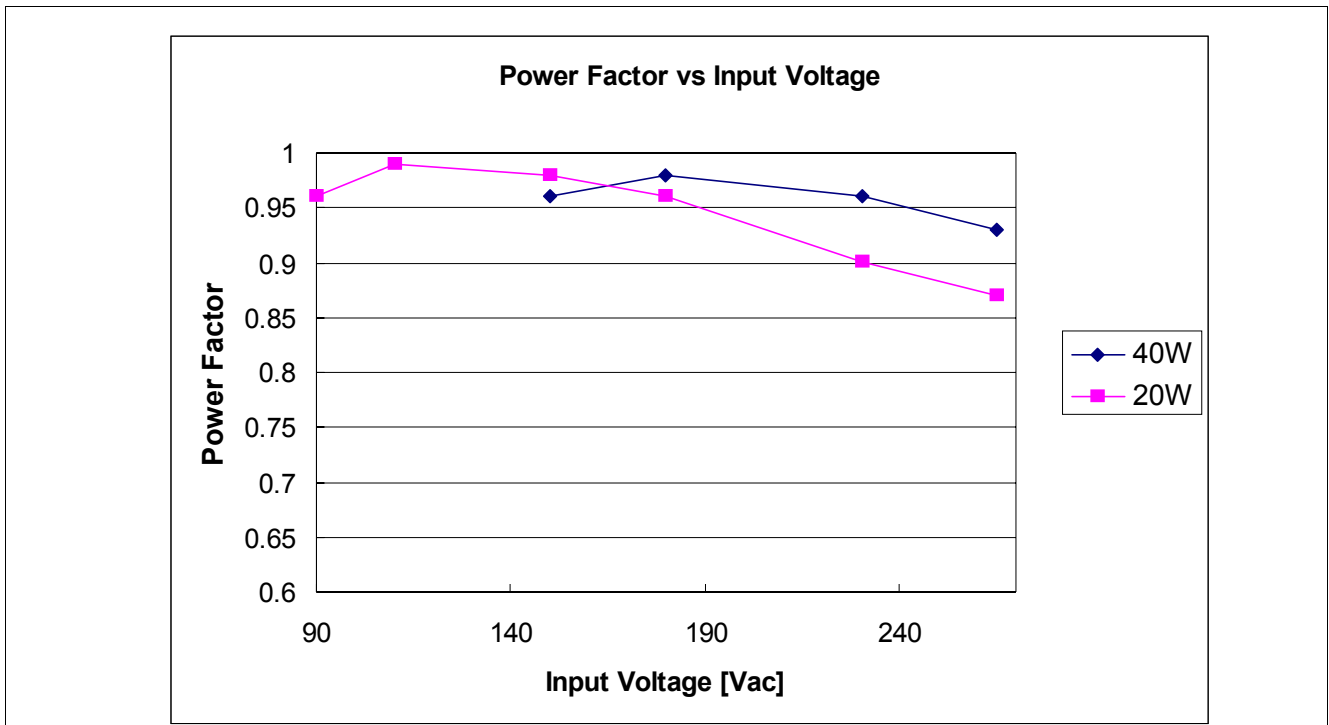

Figure 6-7 Power Factor as function of the input voltage

### 6.7 EMI

The soft switching and inherent jittering of the topology allow for an EMI spectrum compliant to the norm with an low BOM input filter design.

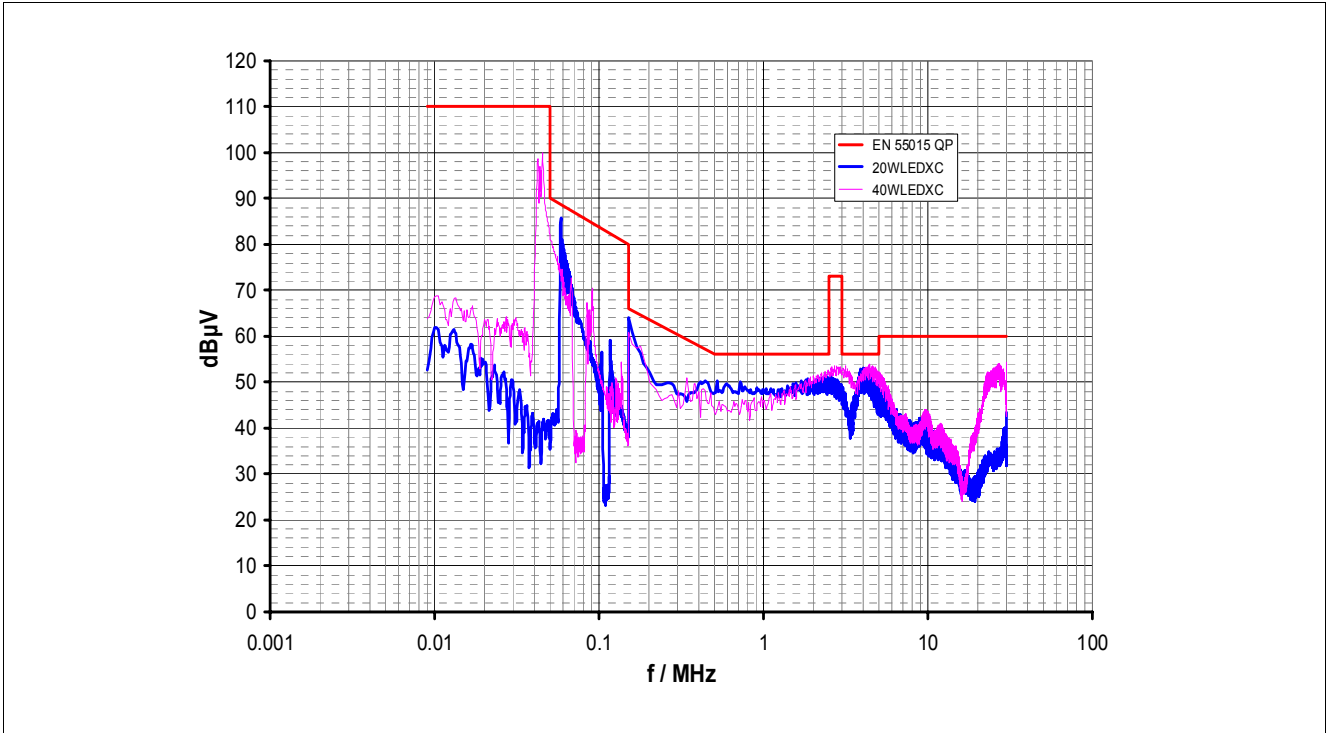

Figure 6-8 EMI Spectrum: C1 and C17 440nF, L1 2x47mH



## 7 Board Layout

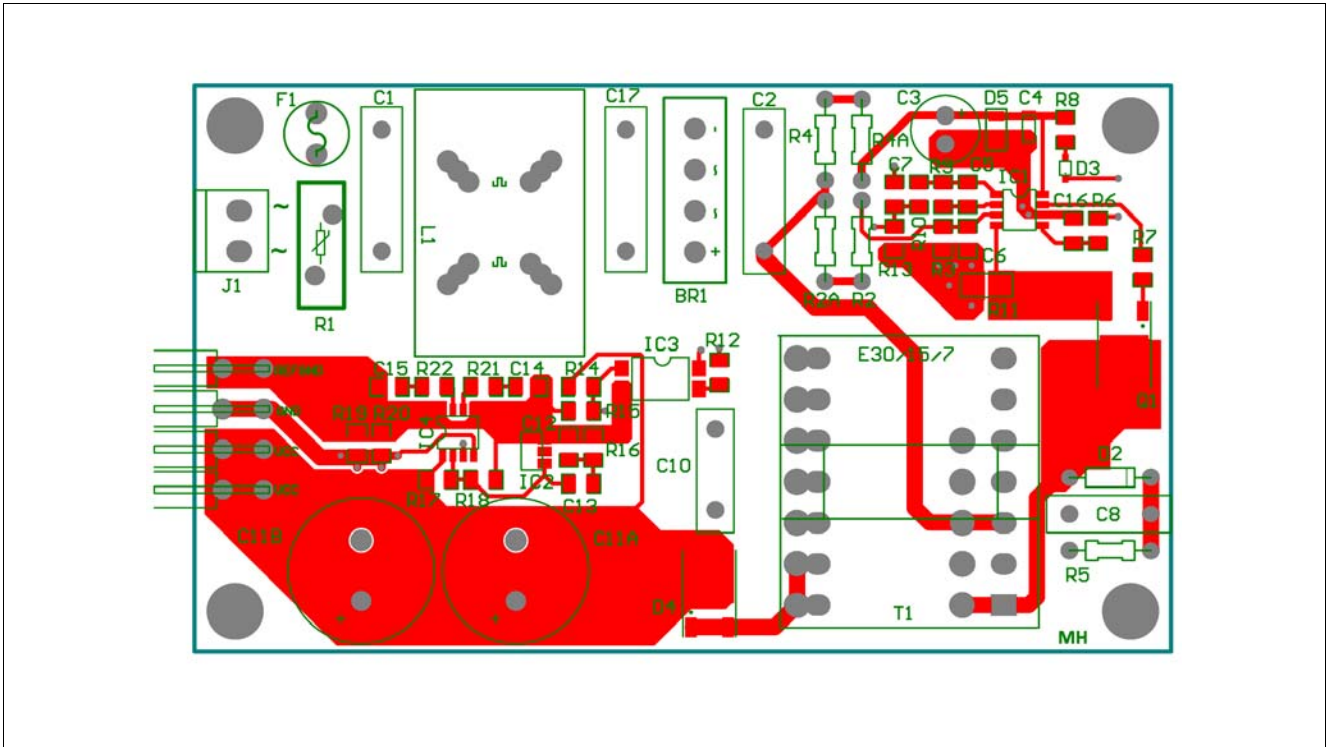

Figure 7-1 EVALLED-TDA4863G-40W Top Layer Routing

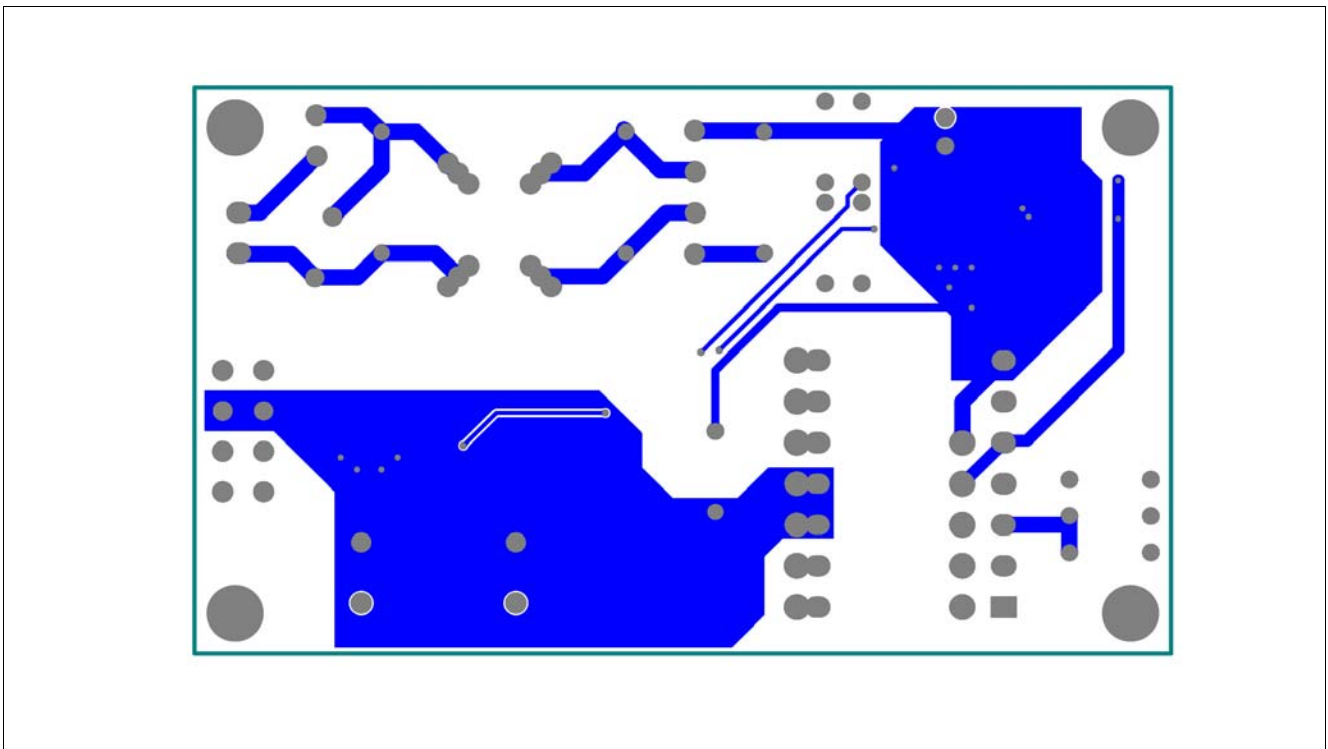

Figure 7-2 EVALLED-TDA4863G-40W Bottom Layer Routing

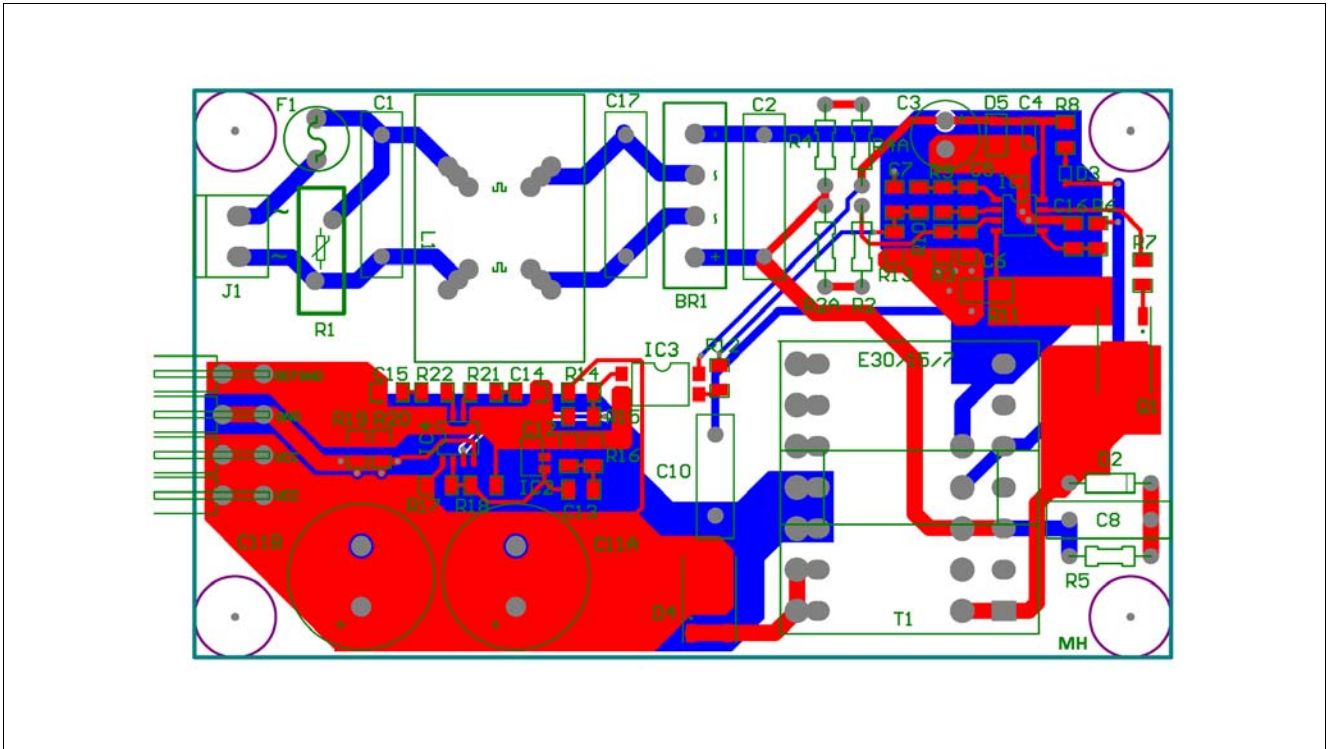

Figure 7-3 EVALLED-TDA4863G-40W Composite Layer View

## 8 Schematic and BOM

### 8.1 Schematic

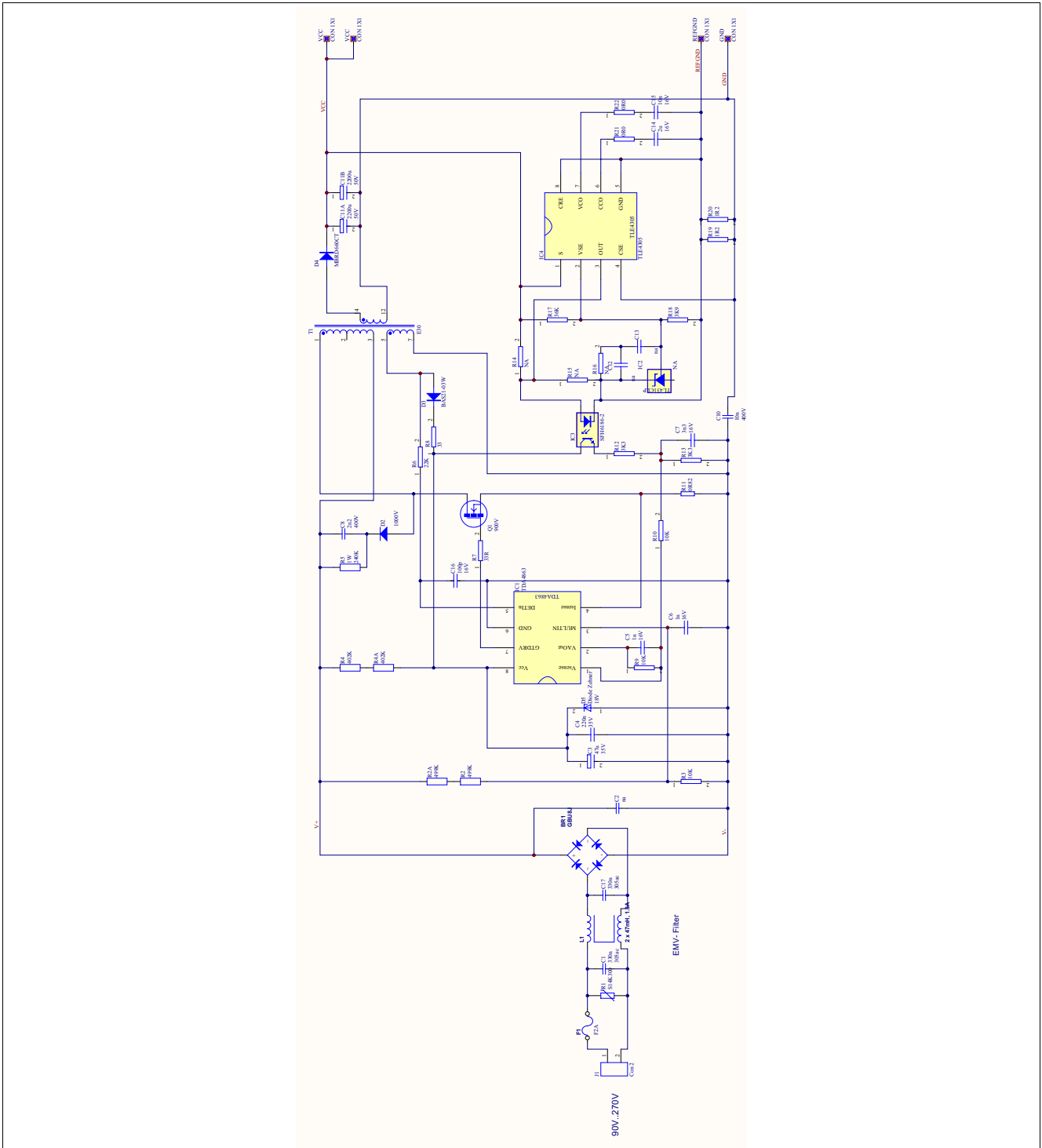

Figure 8-1 EVALLED-TDA4863G-40W Schematic

## 8.2 Bill of Materials

Designator	Value	Rated Voltage	Designator	Value	Rated Voltage
BR1	GBU8J		L1	2x47mH, 1.3A	
C1	330n	305ac	Q1	IPD90R1K2C3	
C2	na		R1	S14K300	
C3	47u	35V	R2	499K	
C4	220n	35V	R2A	499K	
C5	1n	16V	R3	10K	
C6	1n	16V	R4	402K	
C7	3n3	16V	R4A	402K	
C8	2n2	400V	R5	240K	
C10	10n	400V	R6	22K	
C11A	2200u	50V	R7	33R	
C11B	2200u	50V	R8	33	
C12	na		R9	10K	
C13	na		R10	10K	
C14	2u	16V	R11	0R82	
C15	10n	16V	R12	3K3	
C16	100p	16V	R13	3K3	
C17	330n	305ac	R14	NA	
D2	1000V		R15	NA	
D3	BAS21-03W		R16	NA	
D4	6A	60V	R17	36K	
D5		18V	R18	3K9	
F1	F2A		R19	1R2	
IC1	TDA4863		R20	1R2	
IC2	TL431CLP		R21	0R0	
IC3	SFH6186-2		R22	0R0	
IC4	TLE4305		T1	WE 750845240	

Figure 8-2 EVALLED-TDA4863G-40W Bill Of Materials

8.3 Transformer

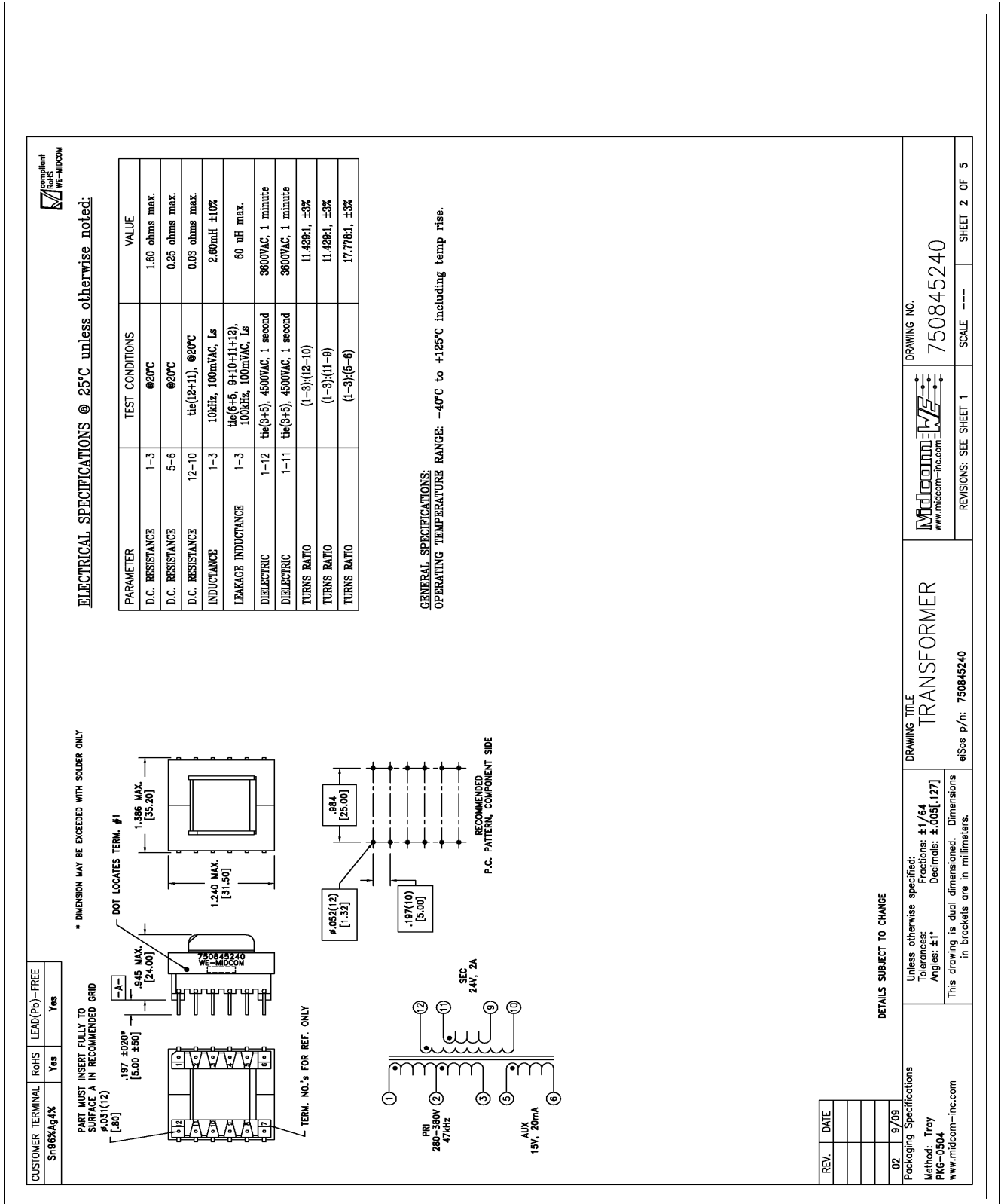

Figure 8-3 EVALLED-TDA4863G-40W Trafo Design

## References

- [1] **TDA4863** datasheet at [www.infineon.com](http://www.infineon.com)
- [2] **TLE4205G** datasheet at [www.infineon.com](http://www.infineon.com)
- [3] **Quasi Resonant Flyback** Application Note at [www.infineon.com](http://www.infineon.com)
- [4] **Quasi Resonant Flyback** Design Tips at [www.infineon.com](http://www.infineon.com)

[www.infineon.com](http://www.infineon.com)