

Ambient Light and Proximity Sensor

Umgebungslicht- und Proximity Sensor

Version alpha.1

SFH 7771

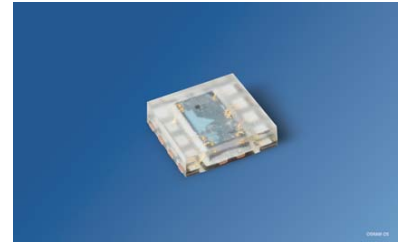

Features:

- Proximity sensor (PS)
 - Detection range up to 250 mm
 - Suitable for Emitters with 850nm...940nm
 - Very good performance behind dark cover glass with 940nm Emitters
 - Programmable pulse current up to 200 mA
- Ambient light sensor (ALS)
 - detection range 0.001 - 43000 lx;
 - 50Hz/60Hz flicker noise suppression
- I²C interface (max. 400kHz)
- PS and ALS Interrupt function
- Current consumption
 - typ. 0.8 µA in Standby mode
 - typ 90µA for ALS operation
 - typ 90µA for PS operation
- Miniature package 2mm x 2.1mm x 0.6mm

Applications

- Mobile phones
- PDAs and notebooks
- Cameras
- Consumer products

Besondere Merkmale:

- Näherungssensor (PS)
 - Detektionsbereich bis zu 250mm
 - Geeignet für Emitter mit 850nm...940nm.
 - Besonders gute Performance hinter dunkler Glasabdeckung mit 940nm Emittern.
 - Programmierbarer Pulsstrom bis 200 mA
- Umgebungslichtsensor (ALS)
 - ALS-Bereich 0.001 - 43000 lx
 - Unterdrückung von 50Hz/60Hz basierten Umgebungslichtstörungen
- I²C interface (max. 400kHz)
- Interrupt Funktion für PS und ALS
- Stromverbrauch
 - typ 0.8 µA im Standby Modus
 - typ 90µA im ALS Modus
 - typ 90µA im PS Modus
- Kleines Gehäuse 2mm x 2.1mm x 0.6mm

Anwendungen

- Mobiltelefone
- PDAs und Notebooks
- Kameras
- Consumer-Produkte

Ordering Information

Bestellinformation

Type:	Ordering Code
Typ:	Bestellnummer
SFH 7771	Q65111A4189

Application diagram 1

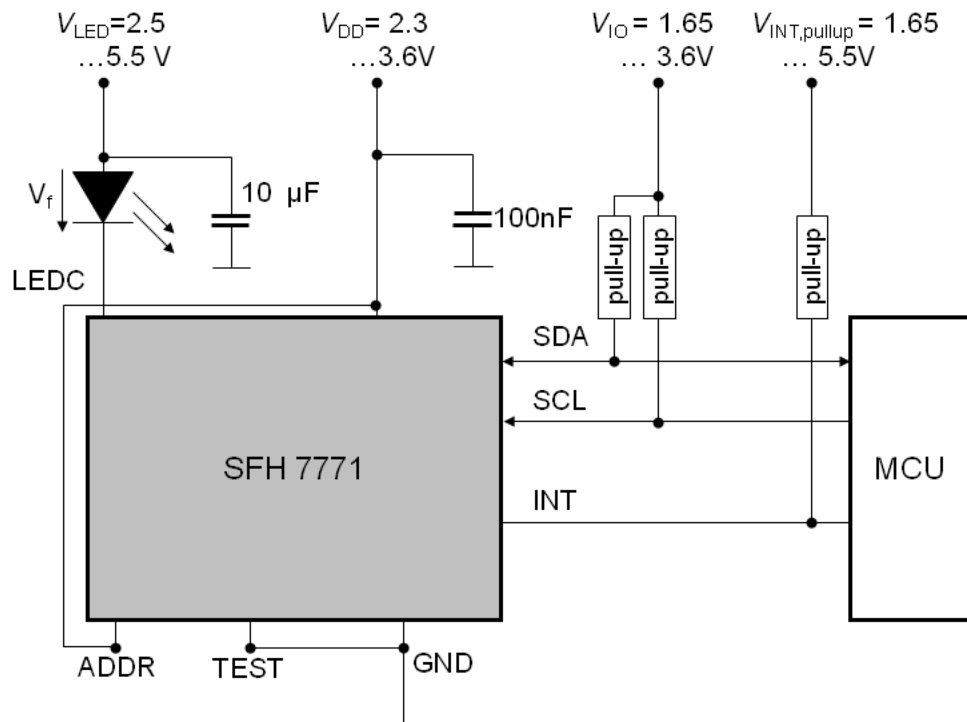

- Cathode of the emitter is directly connected to the sensor (If max = 200 mA)
- Bypass capacitors for V_{DD} and V_{LED} are required for proper operation of the device.
- This example shows ADDR-Pin connected to V_{DD} . Therefore the I²C-Address is 0111001 binary.
- Proposed size for the pull-up resistors are 10kOhm
-

Application diagram 2

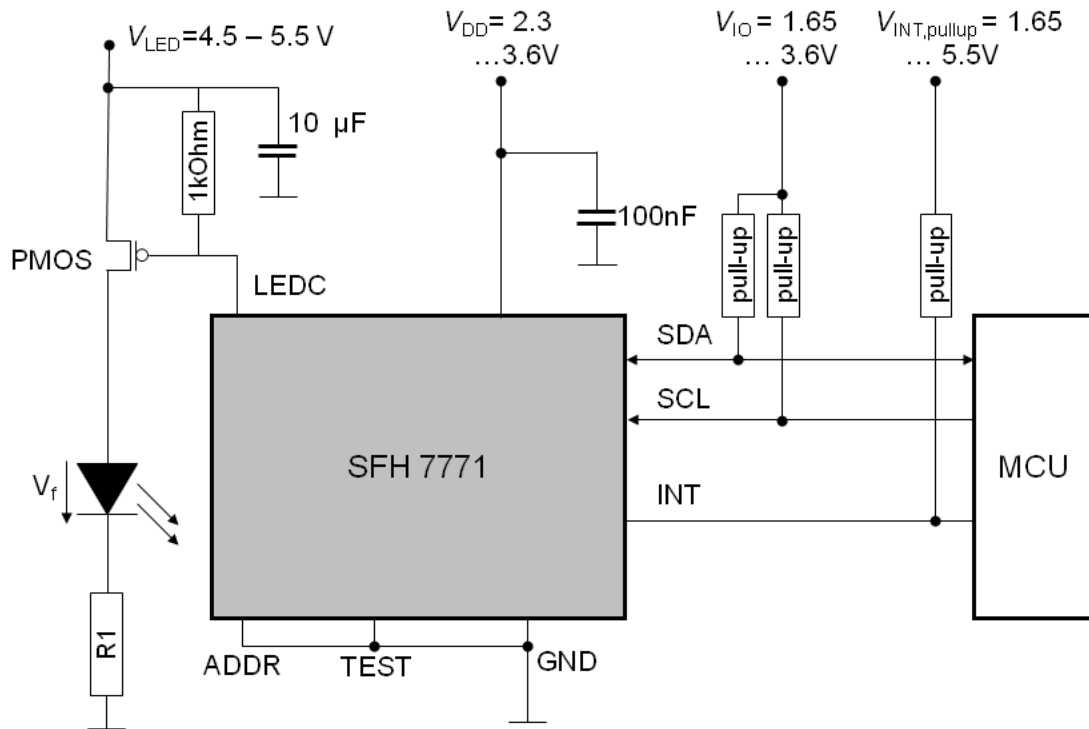

- Emitter is driven externally over a PMOS transistor
- Bypass capacitors for V_{DD} and V_{LED} are required for proper operation of the device.
- This example shows ADDR-Pin connected to V_{DD} . Therefore the I²C-Address is 0111000 binary.
- Proposed size for the pull-up resistors are 10kOhm

Pin configuration

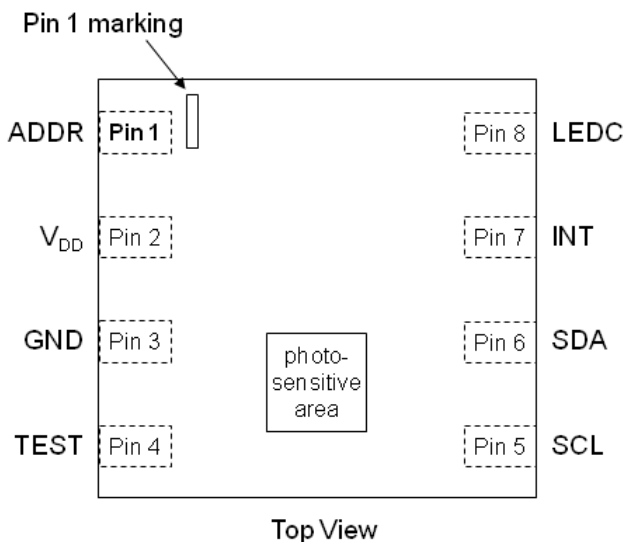

Pin	Name	Function
1	ADDR	I ² C address pin; connect to GND for 0x38 (7 bit-address) V_{DD} for 0x39 (7 bit-address)
2	V_{DD}	Power supply pin
3	GND	Ground pin
4	TEST	Test pin; connect to GND
5	SCL	I ² C bus serial clock pin
6	SDA	I ² C bus serial data pin
7	INT	Interrupt pin; open drain output; configured via I ² C bus
8	LEDC	LED cathode pin; current and interval is defined via I ² C bus

Short Evaluation program

Register	Command	Action
0x42	0x3F	set LED pulse current to 200mA and ALS gain to x128
0x41	0x06	activate ALS & PS with a measurement repetition time of 100ms
Wait 100ms		
0x44	read data	read LSB of proximity measurement data
0x45	read data	read MSB of proximity measurement data
0x46	read data	read LSB of ambient light measurement of VIS diode
0x47	read data	read MSB of ambient light measurement of VIS diode
0x48	read data	read LSB of ambient light measurement of IR diode
0x49	read data	read MSB of ambient light measurement of IR diode

I²C interface

- I/O-pins are open drain type and logic high level is set with external pull-up resistors
- SFH 7771 operates in slave mode. Slave address is 0111000 (0x38) when ADDR-Pin is connected to GND or 0111001 (0x39) if ADDR-pin is connected to V_{DD}
- Designed for the I²C Fast mode (400 kb/s)
- Interrupt pin (INT): open-drain output (like SDA and SCL)

Block diagram

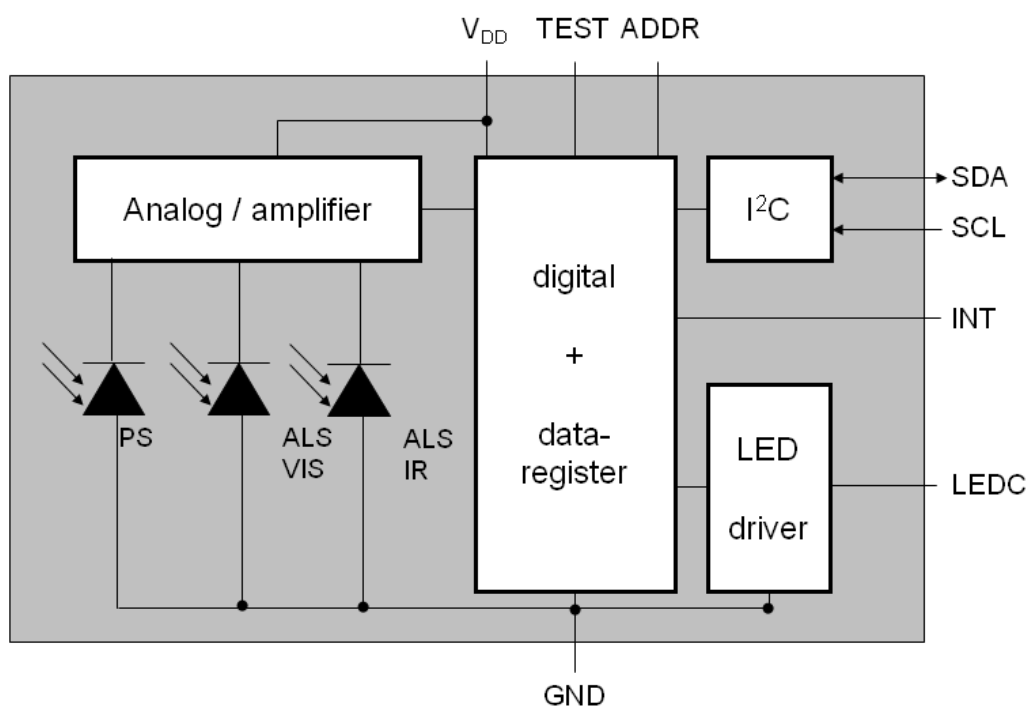

Measurement modes

Mode	Description
OFF	The device is inactive. Other units may use the I ² C bus without any restrictions; I/O pins and INT are in high Z state. There is no sink current through the LED
STAND-BY	This is the initial mode after power-up. I _{DD} is typ. 0.8μA. No measurement is performed. Device can be activated by I ² C bus communication. Data registers can be read and written.
ALS / PS free running	Measurements are triggered internally by the SFH 7771. Stand-by / active mode for ALS and PS, measurement times, interrupt options and LED current can be adjusted via I ² C register. Measurement results can be read from the data register, the status from the interrupt register.

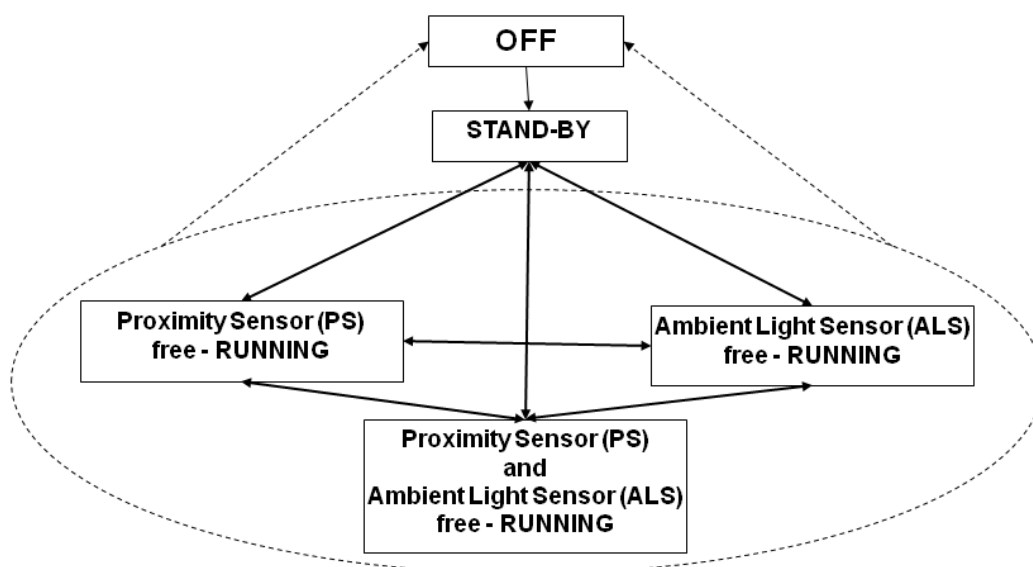

If V_{DD} exceeds the threshold voltage, the sensor will switch from OFF mode to STAND-BY mode. As shown in the transition-diagram above it is possible to switch between all modes without any restriction.

Maximum Ratings $(T_A = 25\text{ °C})$

Parameter	Symbol	Values	Unit
Storage temperature range	T_{stg}	-40 ... 100	°C
Operating temperature range	T_{op}	-40 ... 85	°C
Maximum supply voltage (between V_{DD} and GND)	V_{DD}	4.5	V
Maximum voltage of SDA, SCL to GND	$V_{SDA},$ V_{SCL}	4.5	V
Maximum voltage of INT to GND	V_{INT}	7	V
Maximum voltage of VLED to GND	V_{LEDC}	7	V
Maximum Current of INT and SDA	I_{INT} / I_{SDA}	7	mA
Electrostatic discharge - Human Body Model (according to ANSI / ESDA JEDEC JS-001-2011; Class2)	ESD	2	kV

Operating conditions

Parameter	Symbol	Value			Unit
		min.	typ.	max.	
Supply voltage	V_{DD}	2.3	2.5	3.6	V
Ripple on supply voltage (V_{DDmin} and V_{DDmax} must stay in the V_{DD} range, DC ... 100MHz)	$V_{DD,rip}$			200	mV
V_{DD} threshold voltage (voltage to initiate the start-up procedure)	$V_{DD,th}$		1.7	2.3	V
Pull-up Voltage for INT	$V_{INT,pullup}$			5.5	V
Pull-up Voltage for SCL and SDA	V_{IO}	1.65		3.6	V
SDA and SCL input low level voltage	$V_{SDA_low},$ V_{SCL_low}			0.54	V
SDA and SCL input high level voltage	$V_{SDA_high},$ V_{SCL_high}	1.26			V
SDA and SCL input current	$I_{SDA_low},$ I_{SCL_low}	-10		10	µA
SDA output low level voltage ($I_{INT} = 3\text{ mA}$)	V_{SDA_low}			0.4	V
LEDC Terminal Voltage	V_{LED}	0.7	2.5	5.5	V
Ripple V_{LED}	$V_{LED,rip}$			TBD	mV

Characteristics ($T_A = 25\text{ °C}$)

Parameter	Symbol	Value			Unit
		min.	typ.	max.	

General

Conditions for OFF mode	$V_{DD,off}$		0.5		V
Current consumption in OFF mode ($V_{DD} < 0.5V$)	$I_{DD,off}$		0		μA
STAND-BY mode current consumption (Mode_control(0x41) = 0x00; $V_{DD} = 2.5V$)	$I_{DD,stby}$		0.8	1.5	μA

Proximity Sensor (PS)

Wavelength of maximum sensitivity	$\lambda_{S,max}$		850		nm
Sensitivity range, $\lambda=850nm$	E_e		1 ... 5000		$\mu W/cm^2$
LED ON time for one measurement	$t_{LED\ ON}$	80	200	300	μs
LED current, programmable	I_{LED}	25		200	mA
Accuracy of LED current source (ALS_PS_CONTROL: LED Current = 0b00)	I_{LED}	22.5	25	27.5	mA
Mean current consumption in PS mode (current consumption of the pulsed LED is not included; MODE_CONTROL(0x41) = 0x03; all other registers are default; $V_{DD} = 2.5V$)	I_{DD}		90	150	μA
Mean current consumption in PS mode during the 200 μs LED pulse ($t_{LED\ ON}$) (current consumption of the pulsed LED is not included)	I_{DD}		6.5	8.5	mA
Temperature coefficient of proximity sensor	TC_{PS}		0.15		%/K

Example of Proximity Setup

When proximity sensing is performed, it is desirable that only light from a reflecting object reaches the SFH 7771. Depending on the optical setup, additional and unintended light paths from the IR-Emitter to the detector may exist, which is referred to as '(optical) crosstalk'. One measure to avoid such crosstalk is to add a separator between emitter and detector as drafted in the picture below. For details please refer to our SFH 7771 application note.

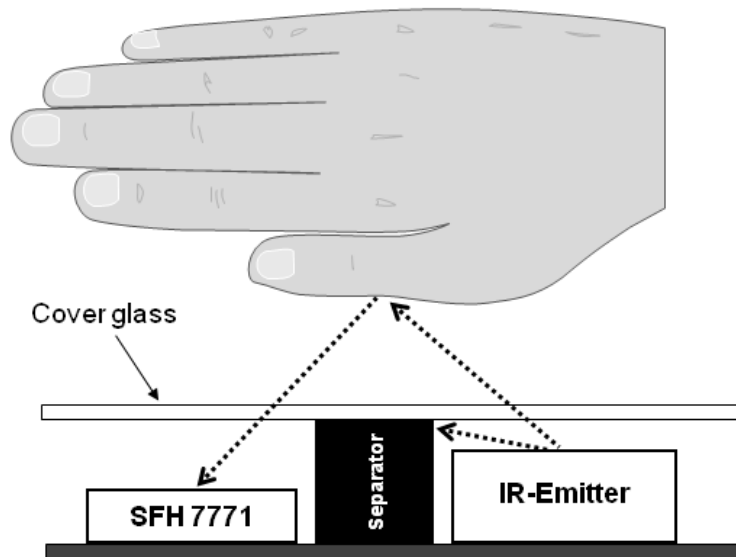

Characteristics (Ta = 25°C)

Parameter	Symbol	Value			Unit
		min.	typ.	max.	

Ambient Light Sensors: ALS_VIS and ALS_IR diode

Wavelength of max. sensitivity for ALS_VIS	$\lambda_{S_{max}}$		520		nm
Spectral range of sensitivity (10% of S_{max}) of ALS VIS	$\lambda_{S10\%}$	380		950	nm
Wavelength of max. sensitivity of ALS_IR	$\lambda_{S_{max}}$		880		nm
Spectral range of sensitivity (10% of S_{max}) of ALS IR	$\lambda_{S10\%}$	800		1070	nm
Illuminance measurement range is programmable (MODE_CONTROL (0x41) = 0x0A or 0x0B)		0.001		43000	lx
ALS_VIS sensor output (1000lx; white LED; $V_{DD} = 2.5V$) (MODE_CONTROL (0x41) = 0x08) (ALS_PS_CONTROL (0x42): Gain = X1)	ALS _{VIS_out}	1275	1500	1725	counts
ALS_IR sensor output (324 μ W/cm ² ; IRED 850 nm; $V_{DD} = 2.5V$) (MODE_CONTROL (0x41) = 0x08) (ALS_PS_CONTROL (0x42): Gain = X1)	ALS _{IR_out}	516	608	700	counts
ALS_VIS sensor output at darkness (MODE_CONTROL (0x41) = 0x08) (ALS_PS_CONTROL (0x42): Gain = X1)	ALS _{VIS_out}	0	0	2	counts
ALS_IR sensor output at darkness (MODE_CONTROL (0x41) = 0x08) (ALS_PS_CONTROL (0x42): Gain = X1)	ALS _{IR_out}	0	0	2	counts
Resolution of the digital output signal based on gain settings for ALS_VIS: MODE_CONTROL (0x41) = 0x08 $t_{int\ ALS} = 100ms$ Gain X1 Gain X2 Gain X 64 Gain X 128 <i>High sensitive mode:</i> MODE_CONTROL (0x41) = 0x0A $t_{int\ ALS} = 400ms$ Gain X 128	ALS _{VIS_out}		0.68 0.34 0.01 0.005 0.001		lx/count

Parameter	Symbol	Value			Unit
		min.	typ.	max.	
Typical temperature coefficient for ALS measurement (1000lx; white LED; $V_{DD} = 2.5V$)	TC_{EV}		0.2		%/K
Mean current consumption ($MODE_CONTROL(0x41) = 0x08$) (other registers are in default)	I_{DD}		90	150	μA
Typical error by Flicker noise (caused by bulbs (f=50 or 60Hz) or fluorescent lamps)				3	%

Diagrams for ALS sensor

Relative Spectral Sensitivity of ALS_VIS

$$S_{rel_VIS} = f(\lambda)$$



Relative Spectral Sensitivity of ALS_IR

$$S_{rel_IR} = f(\lambda); 100\% = \text{maximum sensitivity of ALS_VIS diode}$$

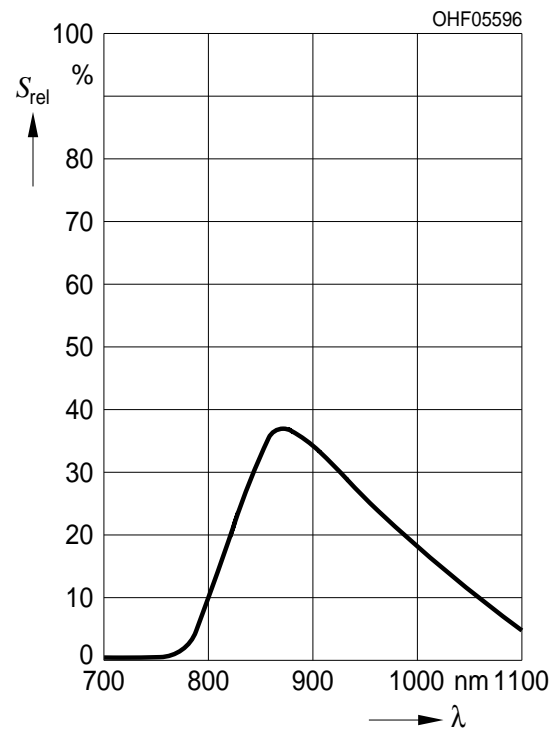

ALS_VIS sensitivity ranges

ALS_VIS output $f(E_v)$; white LED; $f(\text{sensitivity settings})$

T_{int} : integration time (register 0x41); X: gain settings (register 0x42)

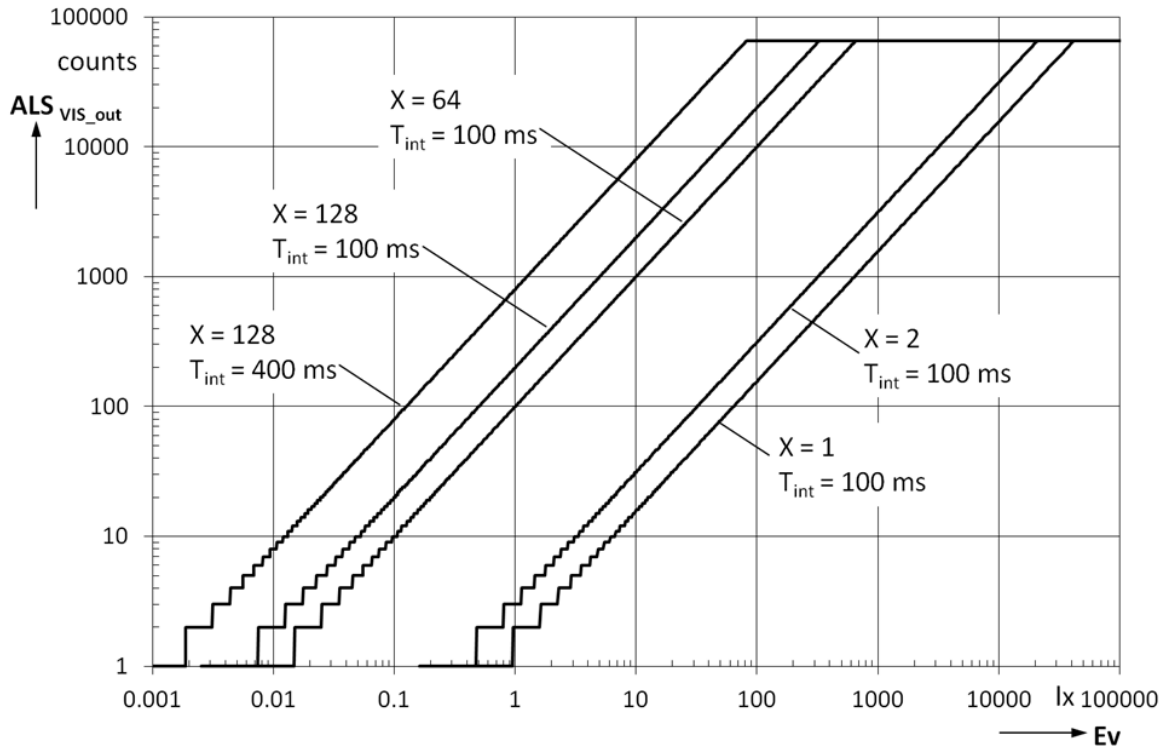

Direction Characteristic of ALS Vis diode

$S_{rel} f(\varphi)$

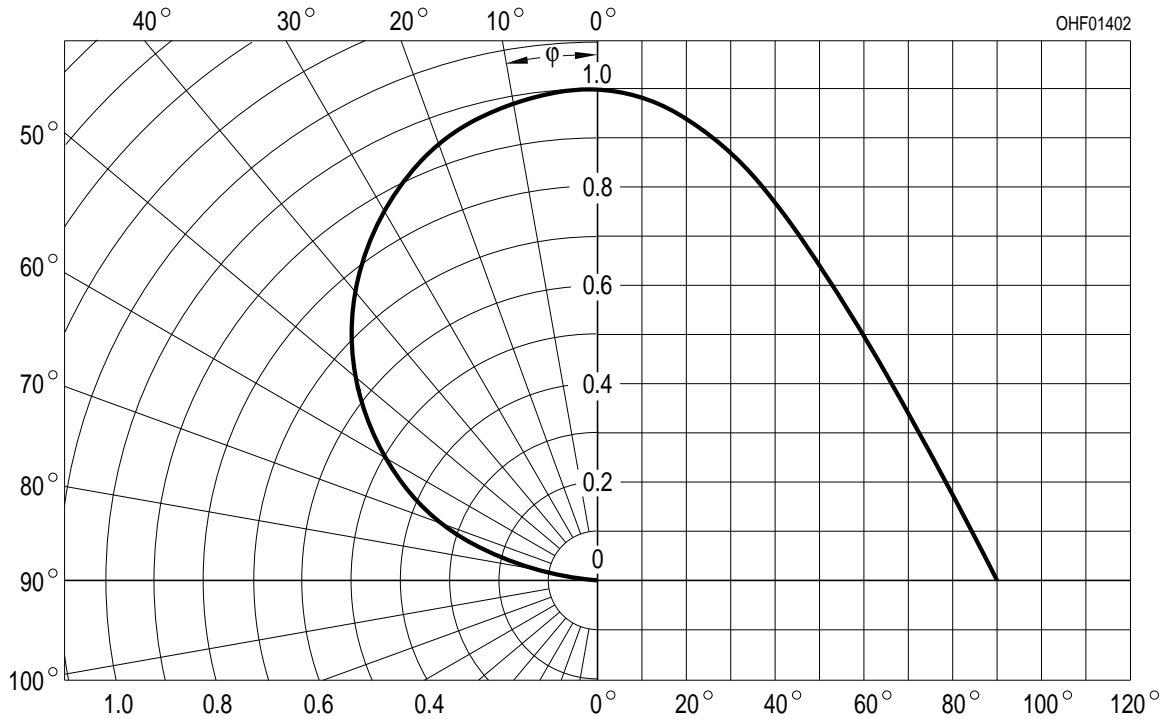

Diagrams for PS sensor

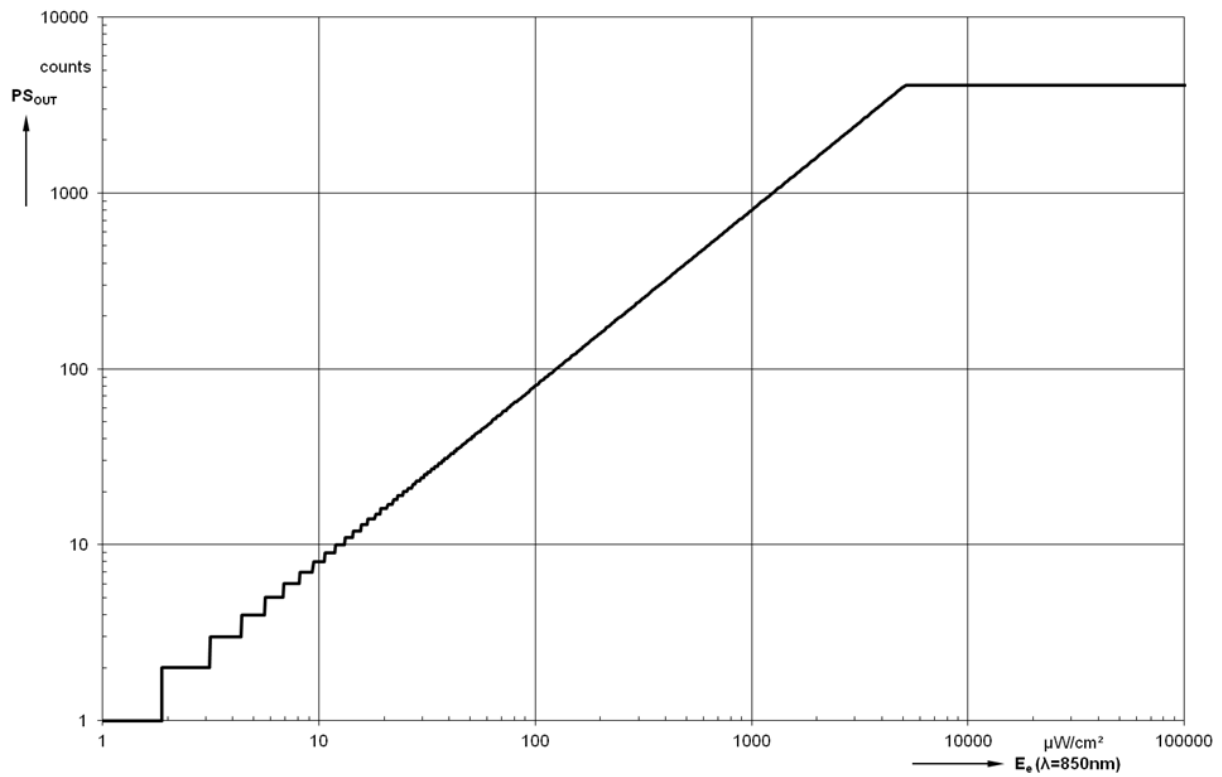
PS sensitivity $f(E_e = \text{irradiance})$ $V_{DD} = 2.5V$; $\lambda = 850nm$ 

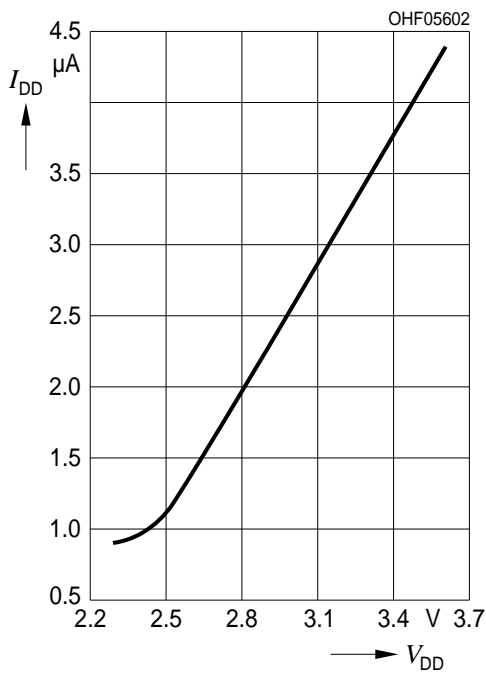
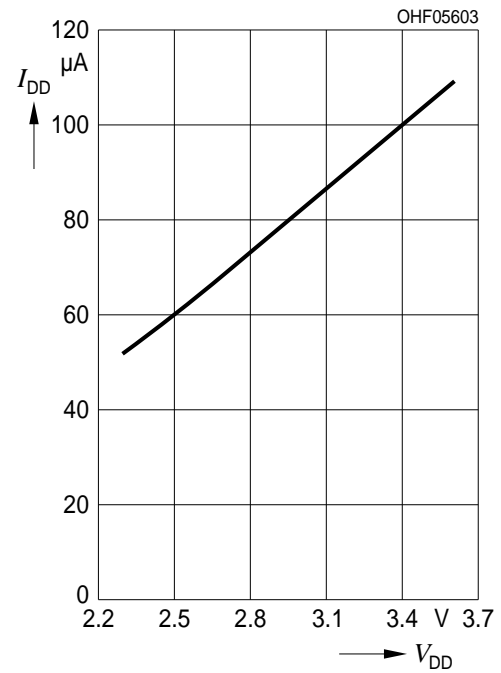
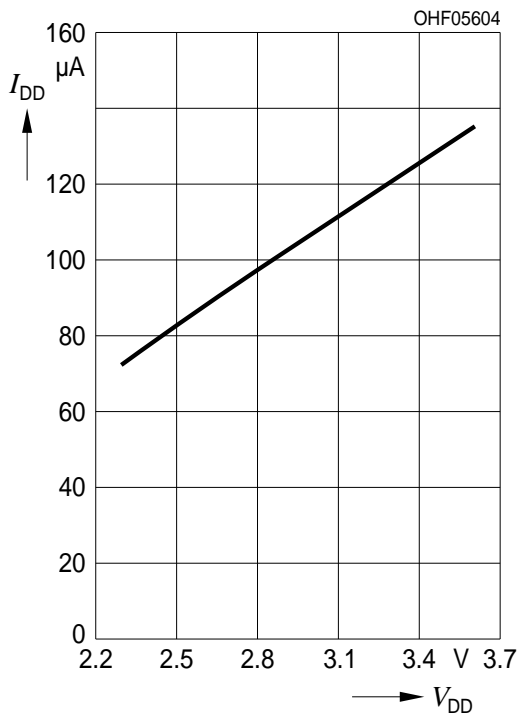
Diagrams for I_{DD} current consumptionCurrent consumption I_{DD} in standby mode $I_{DD} = f(V_{DD})$; Register 0x41= 0x00Current consumption I_{DD} in PS mode $I_{DD} = f(V_{DD})$; Register 0x41= 0x03Current consumption I_{DD} in ALS mode $I_{DD} = f(V_{DD})$; Register 0x41= 0x08

Registers

Register Overview

Register	Type	Name	Function
0x40	R/W	SYSTEM_CONTROL	System Control
0x41	R/W	MODE_CONTROL	ALS and PS General Control
0x42	R/W	ALS_PS_CONTROL	ALS Gain and PS current Control
0x43	R/W	PERSISTENCE	PS Interrupt Persistence Control
0x44	R	PS_DATA_LSB	Output data of PS measurement, LSB
0x45	R	PS_DATA_MSB	Output data of PS measurement, MSB
0x46	R	ALS_VIS_DATA_LSB	Output data of ALS_VIS measurement, LSB
0x47	R	ALS_VIS_DATA_MSB	Output data of ALS_VIS measurement, MSB
0x48	R	ALS_IR_DATA_LSB	Output data of ALS_IR measurement, LSB
0x49	R	ALS_IR_DATA_MSB	Output data of ALS_IR measurement, MSB
0x4A	R/W	INTERRUPT_CONTROL	Interrupt Control
0x4B	R/W	PS_TH_LSB	PS interrupt upper threshold level, LSB
0x4C	R/W	PS_TH_MSB	PS interrupt upper threshold level, MSB
0x4D	R/W	PS_TL_LSB	PS interrupt lower threshold level, LSB
0x4E	R/W	PS_TL_MSB	PS interrupt lower threshold level, MSB
0x4F	R/W	ALS_VIS_TH_LSB	ALS_VIS interrupt upper threshold level, LSB
0x50	R/W	ALS_VIS_TH_MSB	ALS_VIS interrupt upper threshold level, MSB
0x51	R/W	ALS_VIS_TL_LSB	ALS_VIS interrupt lower threshold level, LSB
0x52	R/W	ALS_VIS_TL_MSB	ALS_VIS interrupt lower threshold level, MSB

SYSTEM_CONTROL register (0x40)

The SYSTEM_CONTROL register is used to control the software (SW) reset and the interrupt function (INT). Manufacturer ID and Part ID can be read.

R/W-Register 0x40								
Bit	7	6	5	4	3	2	1	0
	SW reset	INT reset	Manufacturer ID (Read only)			Part ID (Read only)		
default	0 Initial reset is not started	0 INT pin status is not initialized	001			001		
	0 Initial reset is not started	0 INT pin status is not initialized						
	1 Initial reset started	1 INT pin become inactive (high impedance)						

MODE_CONTROL register (0x41)

CONTROL of PS and ALS operating modes and time settings.

Repetition time is the time between two separate measurements. Integration time is the duration for one measurement. ALS high sensitivity modes are 1010 and 1011 with an increased integration time of 400ms. In PS operating mode: „normal mode“ only one PS measurement is performed during one PS repetition time. In PS operating mode „twice mode“ two independent PS measurement are performed within one PS repetition time. Both measurements are independent and can trigger the interrupt. This feature can be used to decrease the interrupt update time if the persistence function (register 0x43) is used.

R/W-Register 0x41										
Bit	7	6	5	4	3	2	1	0	Repetition / Integration time	Repetition time
	Reserved			PS operating mode					ALS	PS
default				0 normal mode	0000				standby	standby
				0 normal mode	0000				standby	standby
				1 twice mode	0001				standby	10ms
					0010				standby	40ms
					0011				standby	100ms
					0100				standby	400ms
					0101				100ms / 100ms	standby
					0110				100ms / 100ms	100ms
					0111				100ms / 100ms	400ms
					1000				400ms / 100ms	standby
					1001				400ms / 100ms	100ms
					1010				400ms / 400ms	standby
					1011				400ms / 400ms	400ms
					1100				50ms / 50ms	50ms
				Rest forbidden						

ALS_PS_CONTROL register (0x42)

ALS and PS Control of set the PS output mode, the ALS gain and the LED current. In the „Infrared DC level output“ PS mode (bit <6> = 1) the sensor measures the infrared DC ambient level. The proximity value of the reflected signal is not available in this mode.

R/W-Register 0x42							
Bit	7	6	5	4	3	2	1 0
	Reserved (read only)	PS output	ALS Gain for ALS_VIS and ALS_IR			LED current	
default	write 0	0 proximity output	0000	X1	X1	11 200mA	
		0 proximity output	0000	X1	X1	00 25 mA	
		1 Infrared DC level output	0100	X2	X1	01 50 mA	
			0101	X2	X2	10 100 mA	
			1010	X64	X64	11 200 mA	
			1110	X128	X64		
			1111	X128	X128		
			rest forbidden				

PERSISTENCE Register (0x43)

Settings of persistence interrupt function. Persistence function is only valid for the PS interrupt.

R/W-Register 0x43								
Bit	7	6	5	4	3	2	1	0
	Reserved (read only)				Persistence			
default	0000				0001 Interrupt status is updated after each measurement			
					0000 Interrupt becomes active after each measurement (The mode indicates that a PS or ALS measurement has been finished and can be read via the register. It is independent of the ALS & PS measurement value and threshold settings)			
					0001 Interrupt status is updated after each measurement (The interrupt status is updated independently after each measurement. <i>Active</i> or <i>Inactive</i> status of the interrupt is depending on the values of the last measurement in combination with the interrupt settings :“interrupt mode“ (register 0x4A) and „thresholds“ register 0x4C and following.)			
					0010 Interrupt status is updated if two consecutive threshold judgement are the same (The interrupt status only changes if the interrupt judgement of 2 consecutive measurement results are the same and different to the current interrupt status.)			
					0011 ... 1111 Interrupt status is updated if threshold judgement are the same over consecutive set times (3 ... 15) (This is the same procedure like in the 0010 persistence mode, but instead of 2 consecutive threshold judgments more are needed (3 to 15 depending on the setting) to change the interrupt status.) e.g.: 1010: 10 measurement results in a row need to fulfill the interrupt judgement to update the interrupt status			

PS_DATA_LSBs register (0x44)

LSB of the PS output.

R-Register 0x44								
Bit	7	6	5	4	3	2	1	0
	2^7	2^6	2^5	2^4	2^3	2^2	2^1	2^0
default	0	0	0	0	0	0	0	0

PS_DATA_MSBs register (0x45)

MSB of the PS output.

R-Register 0x45								
Bit	7	6	5	4	3	2	1	0
	not used	not used	not used	not used	2^{11}	2^{10}	2^9	2^8
default	0	0	0	0	0	0	0	0

ALS_VIS_DATA_LSBs register (0x46)

LSB of the ALS_VIS output.

R-Register 0x46								
Bit	7	6	5	4	3	2	1	0
	2^7	2^6	2^5	2^4	2^3	2^2	2^1	2^0
default	0	0	0	0	0	0	0	0

ALS_VIS_DATA_MSBs register (0x47)

MSB of the ALS_VIS output.

R-Register 0x47								
Bit	7	6	5	4	3	2	1	0
	2^{15}	2^{14}	2^{13}	2^{12}	2^{11}	2^{10}	2^9	2^8
default	0	0	0	0	0	0	0	0

ALS_IR_DATA_LSBs register (0x48)

LSB of the ALS_IR output.

R-Register 0x48								
Bit	7	6	5	4	3	2	1	0
	2^7	2^6	2^5	2^4	2^3	2^2	2^1	2^0
default	0	0	0	0	0	0	0	0

ALS_IR_DATA_MSBs register (0x49)

MSB of the ALS_IR output.

R-Register 0x49								
Bit	7	6	5	4	3	2	1	0
	2^{15}	2^{14}	2^{13}	2^{12}	2^{11}	2^{10}	2^9	2^8
default	0	0	0	0	0	0	0	0

INTERRUPT_CONTROL register (0x4A)

Setting of the interrupt functions.

R/W-Register 0x4A								
Bit	7	6	5	4	3	2	1	0
	PS INT status (read only)	ALS INT status (read only)	PS INT mode		INT assert	INT latch	INT trigger	
default	0 inactive	0 inactive	00 PS_TH is only active		0 INT „L“ is stable	0 INT is latched	00 inactive	
	0 inactive	0 inactive	00 PS_TH (PS high threshold 0x4B & 0x4C) is only active		0 INT „L“ is stable if newer measurement results is also interrupt active	0 INT is latched until INT register is read or initialize	00 INT pin is inactive	
	1 active	1 active	01 PS_TH & PS_TL (PS high & low threshold) are active as hysteresis		1 INT „L“ is de-assert and re-assert if newer measurement results is also interrupt active	1 INT is updated after each measurement	01 triggered by PS only	
			10 PS_TH & PS_TL (PS high & low threshold) are active as outside detection				10 triggered by ALS only	
			11 forbidden				11 triggered by PS or ALS	

PS INT and **ALS INT** status (bit <7;6>): Directly after reading the register the interrupt status for PS and ALS and the INT Pin of the sensor is automatically set back to inactive status independent on the measurement results.

PS INT mode (bit <5;4>): The INT modes are only valid for the PS interrupt function. For description please see extra chapter „**PS INT Modes**“ (at the end of the register chapter).

INT assert (bit <3>): Is used to adjust the sensor behaviour to the used micro controller trigger settings. In case a repeated trigger in low state is needed the **INT assert** can be set to 1.

INT trigger (bit <2>): defines the source / sources for the interrupt.

INT latched (bit <1>): In latched mode the interrupt status stays active after the first activation. It is only released by reading the status are performing an interrupt reset.

PS_TH_LSBs register (0x4B)

LSB for the PS threshold „HIGH“.

R/W-Register 0x4B								
Bit	7	6	5	4	3	2	1	0
	2 ⁷	2 ⁶	2 ⁵	2 ⁴	2 ³	2 ²	2 ¹	2 ⁰
default	1	1	1	1	1	1	1	1

PS_TH_MSBs register (0x4C)

MSB for the PS threshold „HIGH“.

R/W-Register 0x4C								
Bit	7	6	5	4	3	2	1	0
					2^{11}	2^{10}	2^9	2^8
default	0	0	0	0	1	1	1	1

PS_TL_LSBs register (0x4D)

LSB for the PS threshold „LOW“.

R/W-Register 0x4D								
Bit	7	6	5	4	3	2	1	0
	2^7	2^6	2^5	2^4	2^3	2^2	2^1	2^0
default	0	0	0	0	0	0	0	0

PS_TL_MSBs register (0x4E)

MSB for the PS threshold „LOW“.

R/W-Register 0x4E								
Bit	7	6	5	4	3	2	1	0
					2^{11}	2^{10}	2^9	2^8
default	0	0	0	0	0	0	0	0

ALS_VIS_TH_LSBs register (0x4F)

LSB for the ALS_VIS threshold „HIGH“.

R/W-Register 0x4F								
Bit	7	6	5	4	3	2	1	0
	2^7	2^6	2^5	2^4	2^3	2^2	2^1	2^0
default	1	1	1	1	1	1	1	1

ALS_VIS_TH_MSBs register (0x50)

MSB for the ALS_VIS threshold „HIGH“.

R/W-Register 0x50								
Bit	7	6	5	4	3	2	1	0
	2^{15}	2^{14}	2^{13}	2^{12}	2^{11}	2^{10}	2^9	2^8
default	1	1	1	1	1	1	1	1

ALS_VIS_TL_LSBs register (0x51)

LSB for the ALS_VIS threshold „LOW“.

R/W-Register 0x51								
Bit	7	6	5	4	3	2	1	0
	2^7	2^6	2^5	2^4	2^3	2^2	2^1	2^0
default	0	0	0	0	0	0	0	0

ALS_VIS_TL_MSBs register (0x52)

MSB for the ALS_VIS threshold „LOW“.

R/W-Register 0x52								
Bit	7	6	5	4	3	2	1	0
	2^{15}	2^{14}	2^{13}	2^{12}	2^{11}	2^{10}	2^9	2^8
default	0	0	0	0	0	0	0	0

INT modes

The Interrupt function compares ALS and PS measurement values with the current interrupt threshold level. PS and ALS_VIS Interrupt status is readable via register 0x4A or at the INT pin of the sensor.

The Interrupt persistence function is only valid for PS measurements and is defined in register (0x43). The INT pin of the SFH 7771 is open drain output and should be pulled up to $V_{INT,pullup}$ by an external resistor. When V_{DD} is supplied the INT pin is high impedance (inactive). The INT status becomes inactive by writing INT reset command, reading the INT status register or performing a software reset. The INT status stays in its last state when the sensor is set to the standby mode. In the INT active state „low“ the sensor consumes ~25 μ A extra current. Therefore OSRAM recommends to set the INT state to high impedance before setting the sensor in standby mode.

Following ALS and PS INT modes are described for the unlatched mode. In latched mode the switching back to the „inactive“ INT state is depending on a interrupt reset or the read of the INT status register.

ALS INT mode:

The ALS_VIS threshold levels high (register 0x4F & 0x50) and low (register 0x4F & 0x50) are only valid for the ALS_VIS measurement values. The ALS_VIS INT mode is fixed and can not be adapted via register. The thresholds define a window with following functionality:

ALS INT is active, if the ALS_VIS measurement values are outside the window

ALS INT is inactive, if the ALS_VIS measurement results are inside the window.

PS INT Modes: Bit <5;4> of INTERRUPT_CONTROL register (0x4A)**00 PS_TH is only active:**

The INT state is active, if the PS measurement result is equal or higher than the set PS_TH high threshold.

The INT state is inactive, if the PS measurement result is lower than the set PS_TH high threshold.

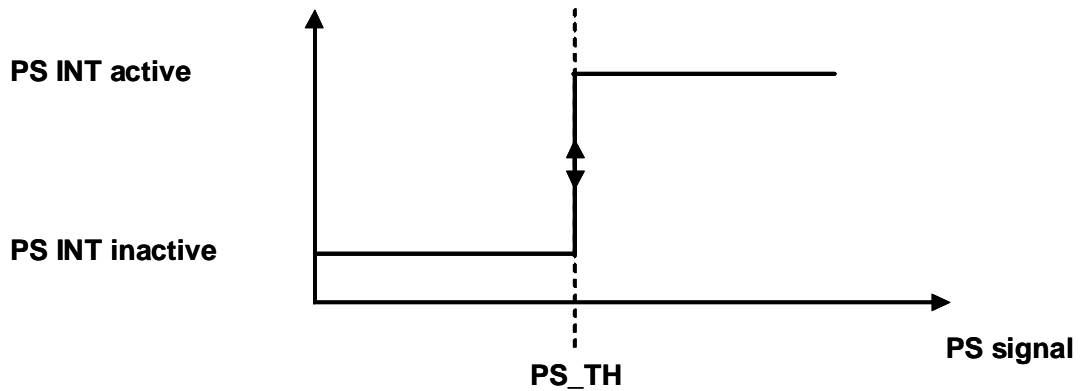

01 PS_TH & PS_TL (PS high & low threshold) are active as hysteresis:

PS_TH and PS_TL are working as a hysteresis. If the PS measurement signal is higher than the PS high threshold (PS_TH) the INT state is switched to active. If the PS measurement signal is lower than the PS low threshold (PS_TL) the INT state is inactive. If once interrupt signal becomes active, INT status is kept active until measurement result becomes less than PS_TL register value.

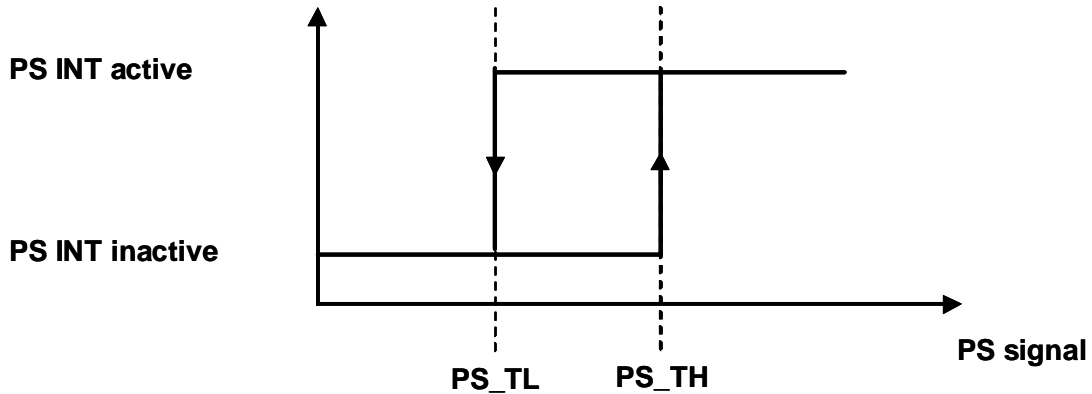

10 PS_TH & PS_TL (PS high & low threshold) are active as outside detection:

In case of „PS outside detection“ mode interrupt signal inactive means that measurement result is within registered threshold level and interrupt signal active means measurement result is out of registered threshold level.

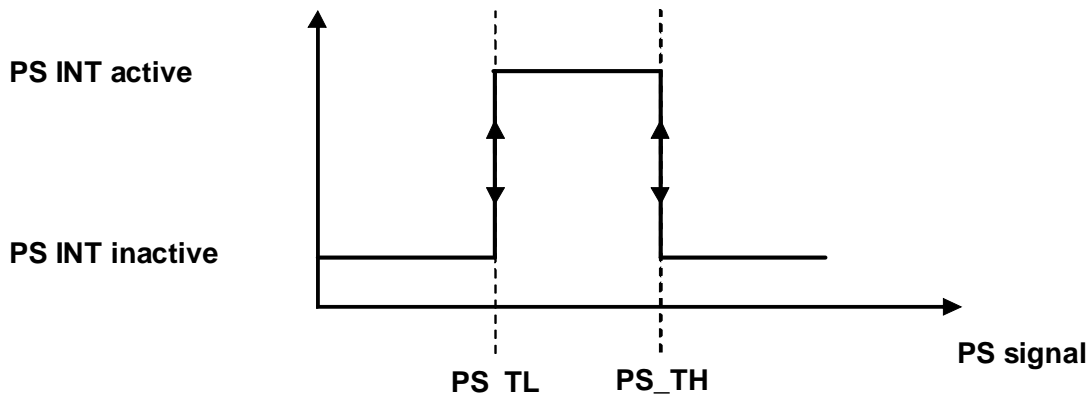

Package Outline

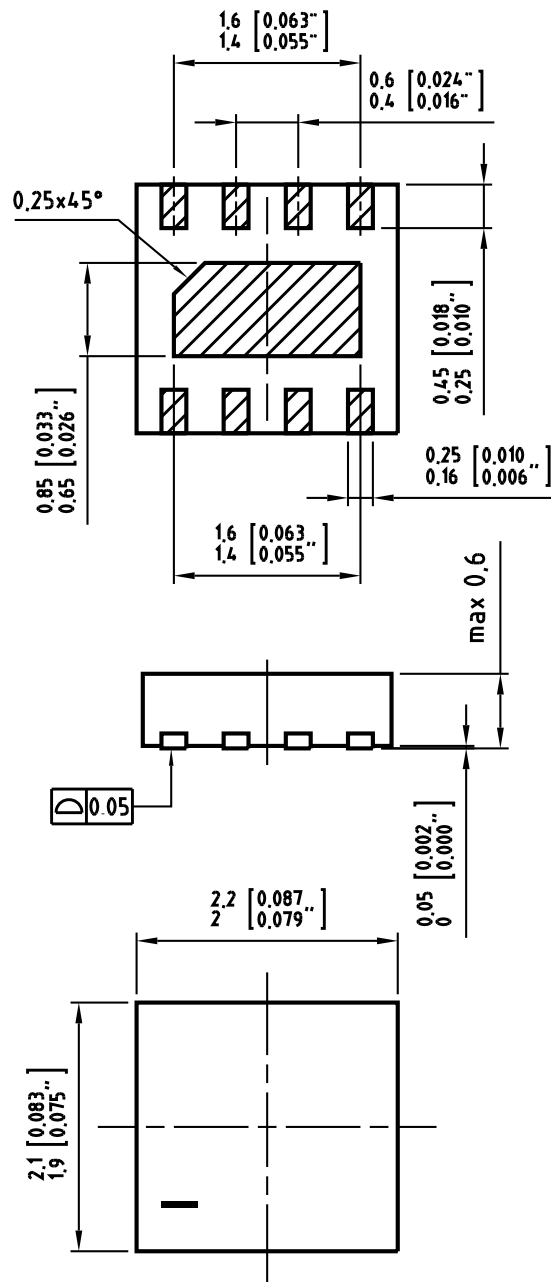

C63062-A4201-A1 -01

Dimensions in mm / Maße in mm.

Contact pins and heatsink are marked as shaded areas in bottom view.

Package

Chiplid

Recommended solder pad design

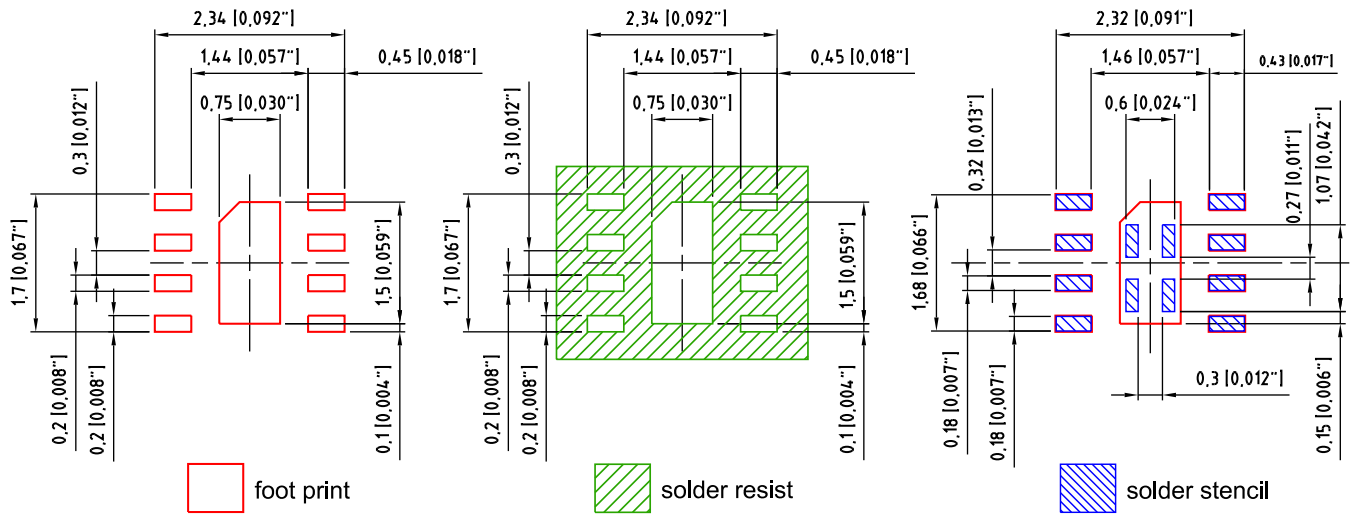

Component Location on Pad

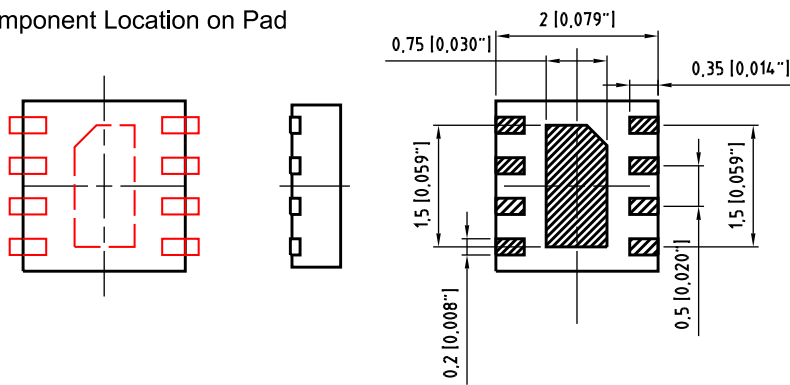

E062.3010.139 -01

Dimensions in mm (inch). / Maße in mm (inch).

Reflow Soldering Profile

Preconditioning: JEDEC Level 3acc. to JEDEC S-STD-020-D

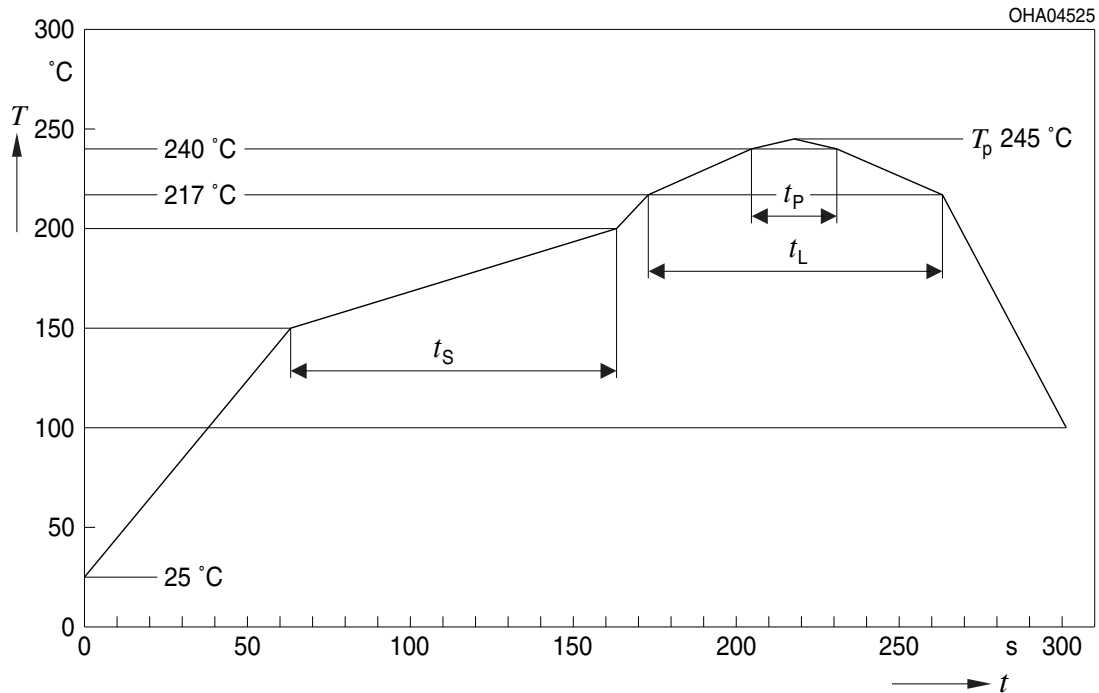

OHA04612

Profile Feature Profil-Charakteristik	Symbol Symbol	Pb-Free (SnAgCu) Assembly			Unit Einheit
		Minimum	Recommendation	Maximum	
Ramp-up rate to preheat*) 25 °C to 150 °C			2	3	K/s
Time t_S T_{Smin} to T_{Smax}	t_S	60	100	120	s
Ramp-up rate to peak*) T_{Smax} to T_P			2	3	K/s
Liquidus temperature	T_L	217			°C
Time above liquidus temperature	t_L		80	100	s
Peak temperature	T_P		245	260	°C
Time within 5 °C of the specified peak temperature $T_P - 5$ K	t_p	10	20	30	s
Ramp-down rate* T_P to 100 °C			3	6	K/s
Time 25 °C to T_P				480	s

All temperatures refer to the center of the package, measured on the top of the component

* slope calculation DT/Dt : Dt max. 5 s; fulfillment for the whole T-range

Disclaimer

OSRAM OS assumes no liability whatsoever for any use of this document or its content by recipient including, but not limited to, for any design in activities based on this preliminary draft version. OSRAM OS may e.g. decide at its sole discretion to stop developing and/or finalizing the underlying design at any time.

Attention please!

The information describes the type of component and shall not be considered as assured characteristics.

Terms of delivery and rights to change design reserved. Due to technical requirements components may contain dangerous substances.

For information on the types in question please contact our Sales Organization. If printed or downloaded, please find the latest version in the Internet.

Packing

Please use the recycling operators known to you. We can also help you – get in touch with your nearest sales office. By agreement we will take packing material back, if it is sorted. You must bear the costs of transport. For packing material that is returned to us unsorted or which we are not obliged to accept, we shall have to invoice you for any costs incurred.

Components used in life-support devices or systems must be expressly authorized for such purpose!

Critical components* may only be used in life-support devices** or systems with the express written approval of OSRAM OS.

*) A critical component is a component used in a life-support device or system whose failure can reasonably be expected to cause the failure of that life-support device or system, or to affect its safety or the effectiveness of that device or system.

**) Life support devices or systems are intended (a) to be implanted in the human body, or (b) to support and/or maintain and sustain human life. If they fail, it is reasonable to assume that the health and the life of the user may be endangered.

Disclaimer

OSRAM OS übernimmt keine wie auch immer geartete Haftung für die Nutzung dieses Dokuments und seines Inhaltes durch den Empfänger, insbesondere nicht für irgendwelche Design-Aktivitäten, die auf dieser vorläufigen Entwurfsversion basieren. OSRAM OS behält sich beispielsweise auch vor, jederzeit die Weiter- und Fertigentwicklung des zugrundeliegenden Designs einseitig einzustellen.

Bitte beachten!

Lieferbedingungen und Änderungen im Design vorbehalten. Aufgrund technischer Anforderungen können die Bauteile Gefahrstoffe enthalten. Für weitere Informationen zu gewünschten Bauteilen, wenden Sie sich bitte an unseren Vertrieb. Falls Sie dieses Datenblatt ausgedruckt oder heruntergeladen haben, finden Sie die aktuellste Version im Internet.

Verpackung

Benutzen Sie bitte die Ihnen bekannten Recyclingwege. Wenn diese nicht bekannt sein sollten, wenden Sie sich bitte an das nächstgelegene Vertriebsbüro. Wir nehmen das Verpackungsmaterial zurück, falls dies vereinbart wurde und das Material sortiert ist. Sie tragen die Transportkosten. Für Verpackungsmaterial, das unsortiert an uns zurückgeschickt wird oder das wir nicht annehmen müssen, stellen wir Ihnen die anfallenden Kosten in Rechnung.

Bauteile, die in lebenserhaltenden Apparaten und Systemen eingesetzt werden, müssen für diese Zwecke ausdrücklich zugelassen sein!

Kritische Bauteile* dürfen in lebenserhaltenden Apparaten und Systemen** nur dann eingesetzt werden, wenn ein schriftliches Einverständnis von OSRAM OS vorliegt.

*) Ein kritisches Bauteil ist ein Bauteil, das in lebenserhaltenden Apparaten oder Systemen eingesetzt wird und dessen Defekt voraussichtlich zu einer Fehlfunktion dieses lebenserhaltenden Apparates oder Systems führen wird oder die Sicherheit oder Effektivität dieses Apparates oder Systems beeinträchtigt.

**) Lebenserhaltende Apparate oder Systeme sind für (a) die Implantierung in den menschlichen Körper oder (b) für die Lebenserhaltung bestimmt. Falls Sie versagen, kann davon ausgegangen werden, dass die Gesundheit und das Leben des Patienten in Gefahr ist.

Published by OSRAM Opto Semiconductors GmbH
Leibnizstraße 4, D-93055 Regensburg
www.osram-os.com © All Rights Reserved.

EU RoHS and China RoHS compliant product



此产品符合欧盟 RoHS 指令的要求；
按照中国的相关法规和标准，不含有毒有害物质或元素。