

# NPN Silicon Phototransistors

## Types OP800WSL, OP801WSL, OP802WSL

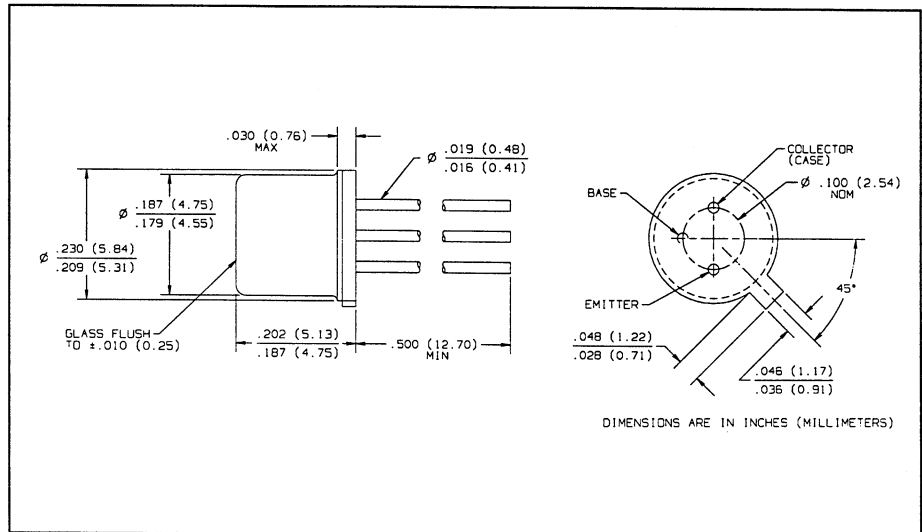
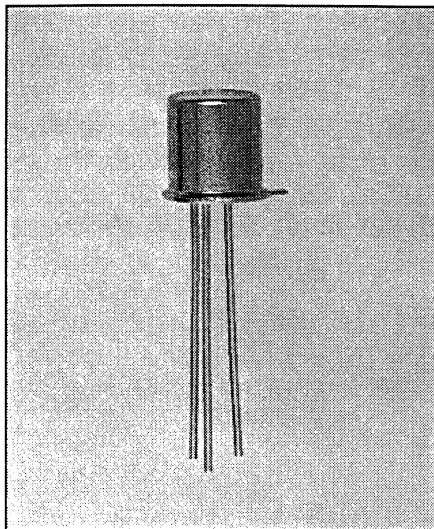

### Features

- Wide receiving angle
- Variety of sensitivity ranges
- Enhanced temperature range
- TO-18 hermetically sealed package
- Mechanically and spectrally matched to the OP130W and OP231W series emitters

### Description

The OP800WSL series device consists of an NPN silicon phototransistor mounted in a hermetically sealed package. The wide receiving angle provides relatively even reception over a large area. TO-18 packages offer high power dissipation and superior hostile environment operation.

### Replaces

OP800W and K5201 series

### Absolute Maximum Ratings ( $T_A = 25^\circ\text{C}$ unless otherwise noted)

Collector-Emitter Voltage .....	30 V
Emitter-Collector Voltage .....	5.0 V
Continuous Collector Current .....	50 mA
Storage Temperature Range .....	$-65^\circ\text{C}$ to $+150^\circ\text{C}$
Operating Temperature Range .....	$-65^\circ\text{C}$ to $+125^\circ\text{C}$
Lead Soldering Temperature [1/16 inch (1.6 mm) from case for 5 sec. with soldering iron] .....	$260^\circ\text{C}^{(1)}$
Power Dissipation .....	$250\text{mW}^{(2)}$

#### Notes:

- (1) RMA flux is recommended. Duration can be extended to 10 sec. max. when flow soldering.
- (2) Derate linearly  $2.5\text{mW}/^\circ\text{C}$  above  $25^\circ\text{C}$ .
- (3) Junction temperature maintained at  $25^\circ\text{C}$ .
- (4) Light source is an unfiltered tungsten bulb operating at  $CT = 2870\text{K}$  or equivalent infrared source.

### Typical Performance Curves

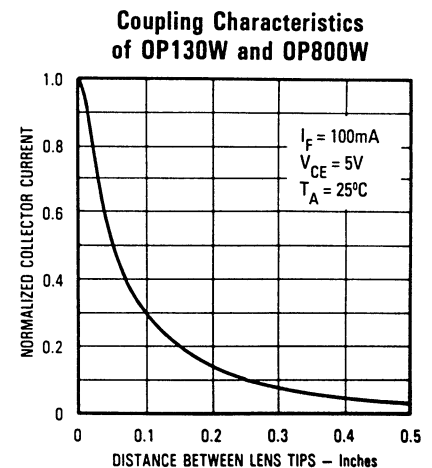
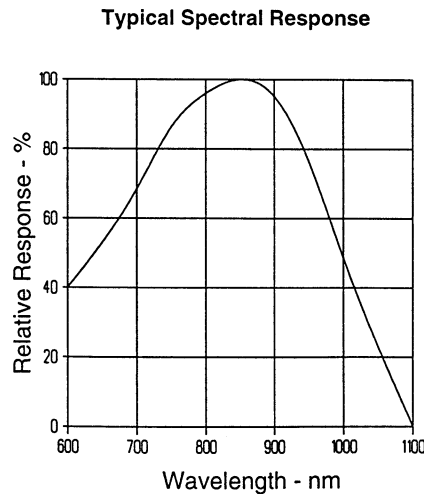

# Types OP800WSL, OP801WSL, OP802WSL

Electrical Characteristics ( $T_A = 25^\circ\text{C}$  unless otherwise noted)

SYMBOL	PARAMETER	MIN	TYP	MAX	UNITS	TEST CONDITIONS
$I_{C(ON)}^{(3)}$	On-State Collector Current	OP800WSL OP801WSL OP802WSL	0.3 0.5 2.5		mA mA mA	$V_{CE} = 5\text{ V}, E_e = 5\text{ mW/cm}^2(4)$
$I_{CEO}$	Collector Dark Current			100	nA	$V_{CE} = 10\text{ V}, E_e = 0$
$V_{(BR)CEO}$	Collector-Emitter Breakdown Voltage	30			V	$I_C = 100\ \mu\text{A}$
$V_{(BR)ECO}$	Emitter-Collector Breakdown Voltage	5.0			V	$I_E = 100\ \mu\text{A}$
$V_{CE(SAT)}^{(3)}$	Collector-Emitter Saturation Voltage			0.40	V	$I_C = 0.15\text{ mA}, E_e = 0.5\text{ mW/cm}^2(4)$
$t_r$	Rise Time		7.0		$\mu\text{s}$	$V_{CC} = 5\text{ V}, I_C = 0.80\text{ mA}, R_L = 100\ \Omega, \text{ See Test Circuit}$
$t_f$	Fall Time		7.0		$\mu\text{s}$	

PHOTOSENSORS

## Typical Performance Curves

**Collector Dark Current vs. Ambient Temperature**

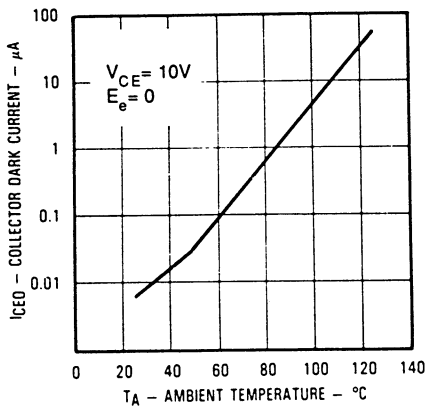

**Normalized Collector Current vs. Ambient Temperature**

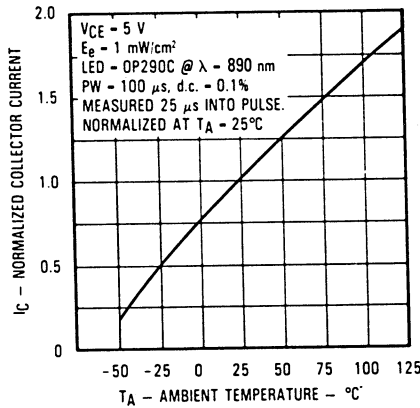

**Collector Current vs. Irradiance**

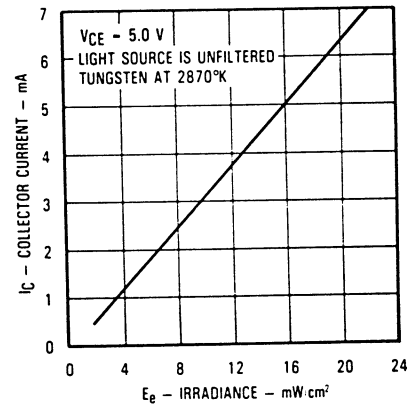

**Rise and Fall Time vs. Load Resistance**

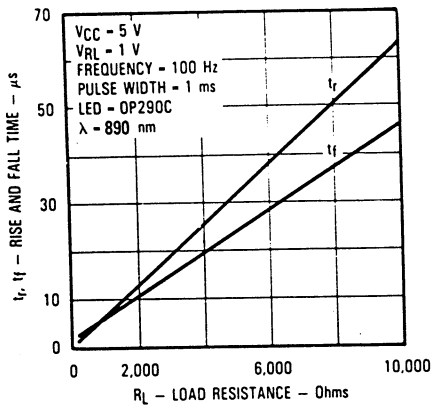

**Normalized Collector Current vs. Angular Displacement**

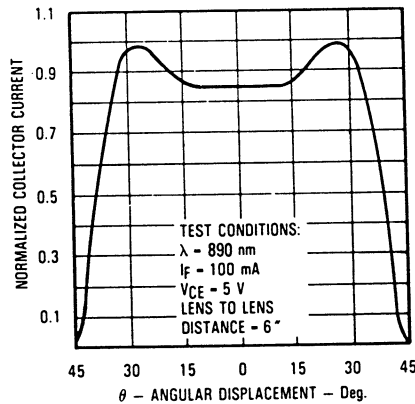

**Switching Time Test Circuit**

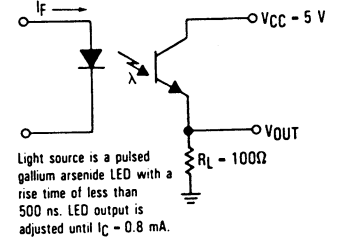

Optek reserves the right to make changes at any time in order to improve design and to supply the best product possible.

Optek Technology, Inc. 1215 W. Crosby Road Carrollton, Texas 75006 (972)323-2200 Fax (972)323-2396