

# HSMD-Cxxx, HSMG-Cxxx, HSMH-Cxxx, HSMS-Cxxx, HSMY-Cxxx, Surface Mount Chip LEDs



## Data Sheet

**HSMx-C110/HSMx-C120/HSMx-C150/HSMx-C170/HSMx-C177/  
HSMx-C190/HSMx-C191/HSMx-C197/HSMx-C265**



### Description

These chip LEDs are designed in an industry standard package for ease of handling and use. Various different LED colors are available in nine compact, single color packages.

The HSMx-C150 has the industry standard 3.2 x 1.6 mm footprint that is excellent for all around use. The HSMx-C170 has the widely used 2.0 x 1.25 mm foot-print with 0.8 mm profile. The HSMx-C177 has the widely used 2.0 x 1.25 mm footprint with 0.4 mm profile. The HSMx-C19x series has the industry standard 1.6 x 0.8 mm footprint with varying profile to suit designers needs, the HSMx-C190 has 0.8 mm profile, the HSMx-C191 has a low profile of 0.6 mm, and the HSMx-C197 has the ultra low profile of 0.4 mm. This family with its thin profile and wide viewing angle makes this LED exceptional for back-lighting applications.

The HSMx-C110 is a right angle package with the universally accepted dimensions of 3.2 x 1.0 x 1.5 mm. The HSMx-C120 is a smaller right angle package with industry standard 1.6 x 0.6 x 1.0 mm. HSMx-C265 is a reverse mount package with dimensions of 3.4 x 1.25 x 1.1 mm. These devices are ideal for LCD backlighting and side-lighting applications.

In order to facilitate pick and place operation, these chip LEDs are shipped in tape and reel with 4000 units per reel for HSMx-C120, C170, C177, C190, C191, C197 packages, and 3000 units per reel for HSMx-C110, C150, C265 packages.

All packages are compatible with IR reflow solder processes. The small size and wide viewing angle make these LEDs prime choices for backlighting applications and front panel illumination especially where space is a premium.

### Features

- Small size
- Industry standard footprint
- Compatible with IR solder
- Diffused optics
- Operating temperature range of -40°C to +85°C
- Right angle & reverse mount package available
- Various colors available
- Available in 8 mm tape on 7 in. (178 mm) diameter reels

### Applications

- Keypad backlighting
- Push-button backlighting
- LCD backlighting
- Symbol backlighting
- Front panel indicator

## Device Selection Guide

### GaP

| Green     | HER       | Orange    | Yellow    | Description            |
|-----------|-----------|-----------|-----------|------------------------|
| HSMG-C110 | HSMS-C110 | HSMD-C110 | HSMY-C110 | Untinted, Non-Diffused |
| HSMG-C120 | HSMS-C120 | HSMD-C120 | -         | Untinted, Non-Diffused |
| HSMG-C150 | HSMS-C150 | HSMD-C150 | HSMY-C150 | Untinted, Diffused     |
| HSMG-C170 | HSMS-C170 | HSMD-C170 | HSMY-C170 | Untinted, Diffused     |
| HSMG-C177 | HSMS-C177 | HSMD-C177 | HSMY-C177 | Untinted, Diffused     |
| HSMG-C190 | HSMS-C190 | HSMD-C190 | HSMY-C190 | Untinted, Diffused     |
| HSMG-C191 | HSMS-C191 | HSMD-C191 | HSMY-C191 | Untinted, Diffused     |
| HSMG-C197 | HSMS-C197 | HSMD-C197 | HSMY-C197 | Untinted, Diffused     |
| HSMG-C265 | -         | -         | -         | Untinted, Non-Diffused |

### As AlGaAs

| Red       | Description            |
|-----------|------------------------|
| HSMH-C110 | Untinted, Non-Diffused |
| HSMH-C120 | Untinted, Non-Diffused |
| HSMH-C150 | Untinted, Diffused     |
| HSMH-C170 | Untinted, Diffused     |
| HSMH-C190 | Untinted, Diffused     |
| HSMH-C191 | Untinted, Diffused     |
| HSMH-C265 | Untinted, Non-Diffused |

## Package Dimensions

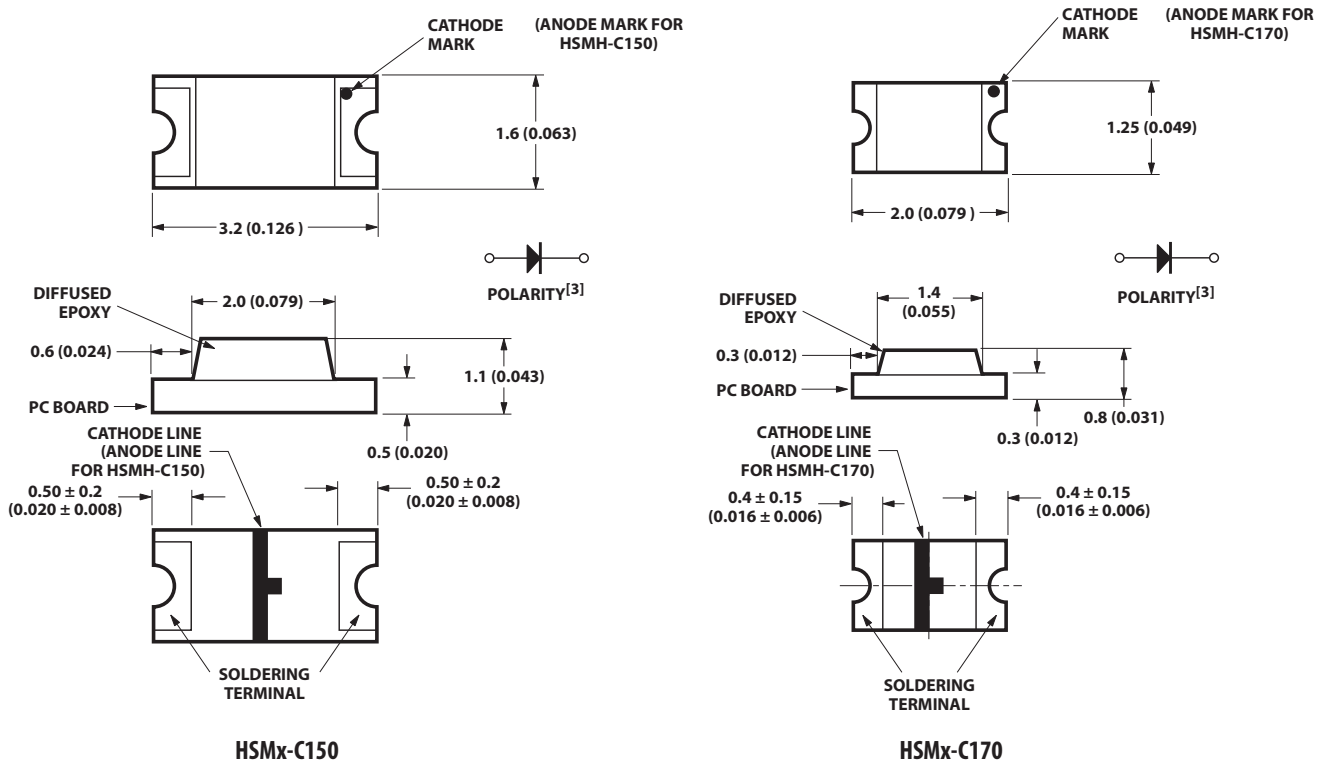

#### Notes:

1. All dimensions in millimeters (inches).
2. Tolerance is  $\pm 0.1$  mm ( $\pm 0.004$  in.) unless otherwise specified.
3. Polarity for HSMH-Cxxx will be the opposite of what is shown on above drawings.

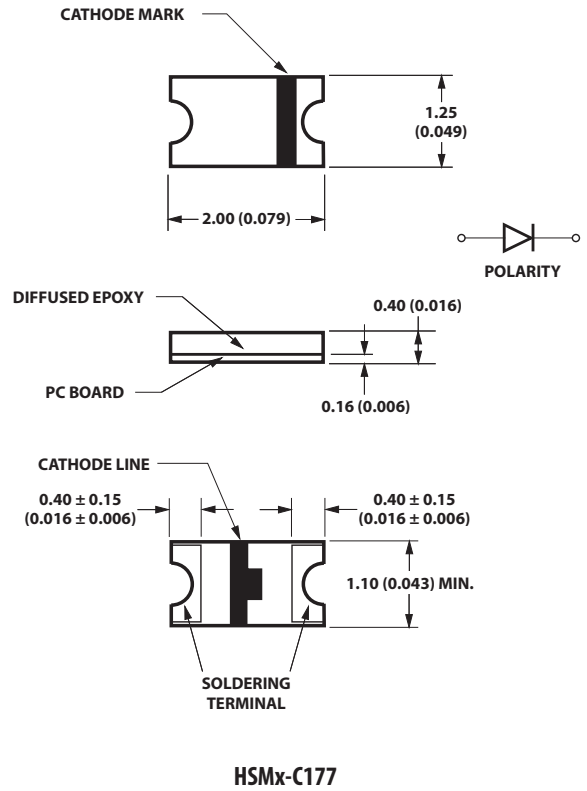
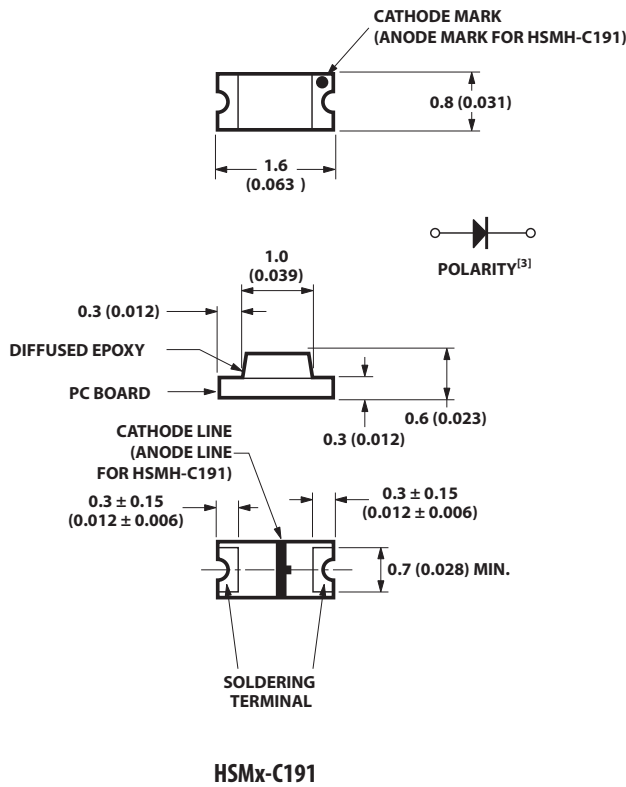
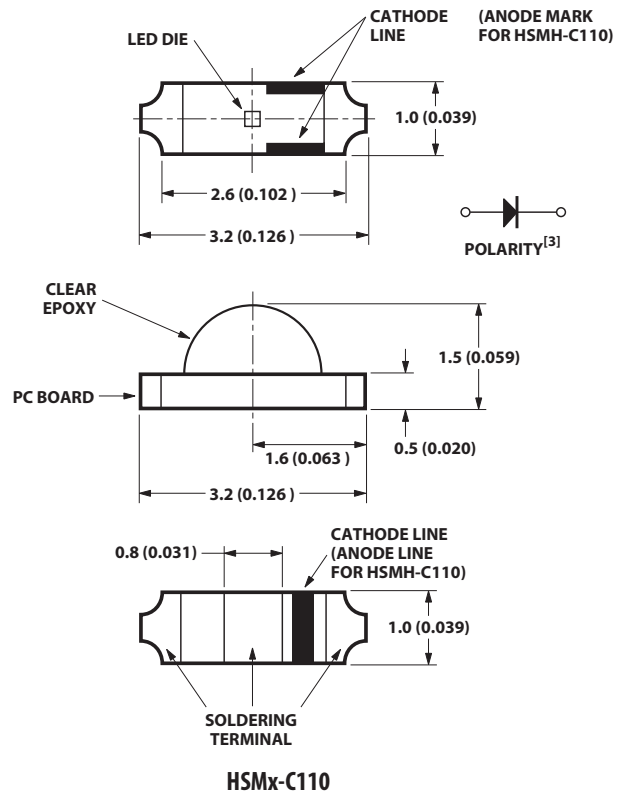
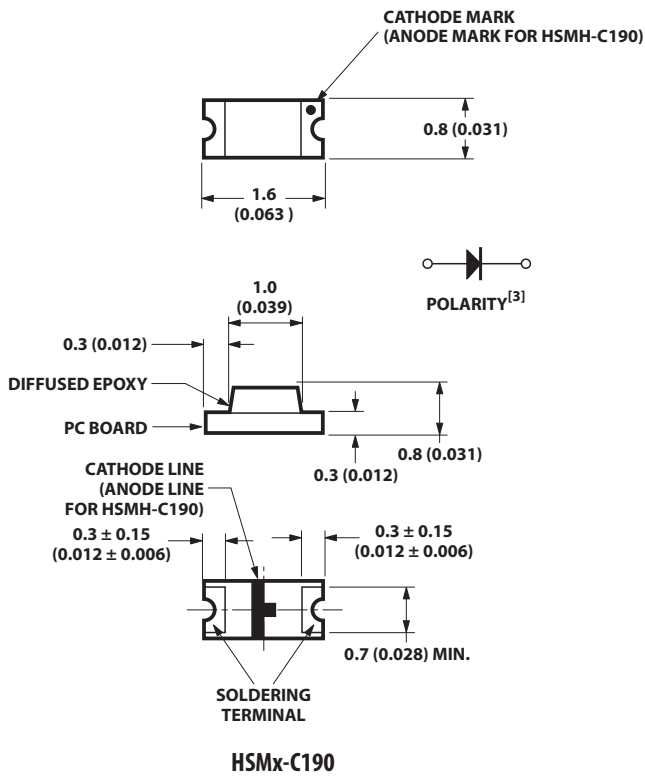

**Notes:**

1. All dimensions in millimeters (inches).
2. Tolerance is  $\pm 0.1$  mm ( $\pm 0.004$  in.) unless otherwise specified.
3. Polarity for HSMH-Cxxx will be the opposite of what is shown on above drawings.

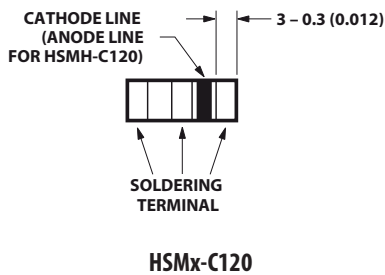
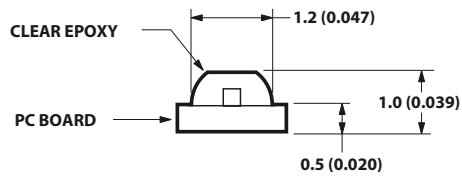
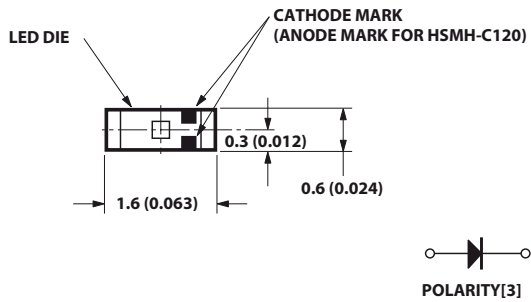
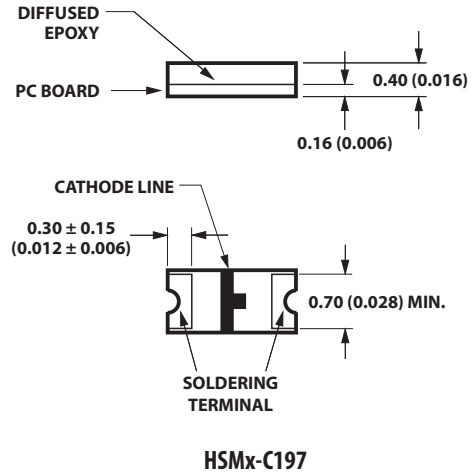
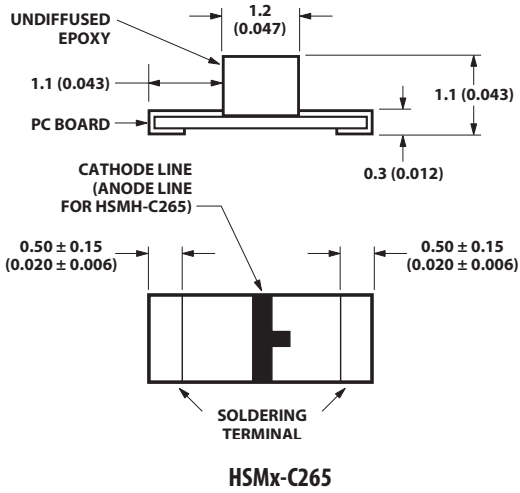
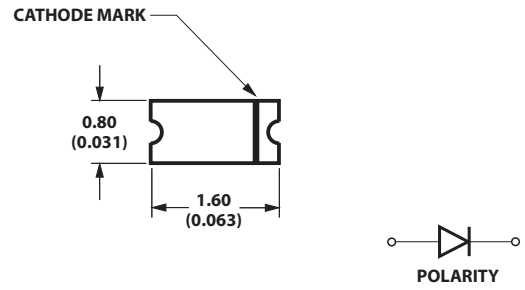
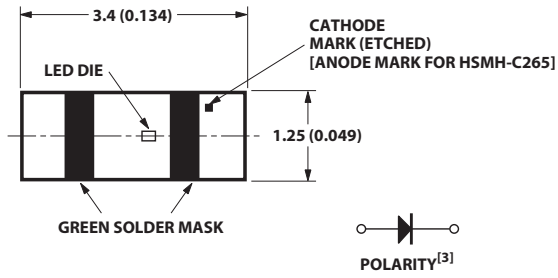

**Notes:**

1. All dimensions in millimeters (inches).
2. Tolerance is ±0.1 mm (±0.004 in.) unless otherwise specified.
3. Polarity for HSMH-Cxxx will be the opposite of what is shown on above drawings.

### Absolute Maximum Ratings for GaP at $T_A=25^\circ\text{C}$

| Parameter                                  | C110/150/265                                 | C120/170/177/190/191/197 | Units            |
|--|--|--------------------------|------------------|
| DC Forward Current <sup>[1]</sup>          | 25   | 20                       | mA               |
| Power Dissipation                          | 65   | 52                       | mW               |
| Reverse Voltage ( $I_R=100\ \mu\text{A}$ ) | 5  | 5                        | V                |
| LED Junction Temperature                   | 95   | 95                       | $^\circ\text{C}$ |
| Operating Temperature Range                | -40 to +85                                   | -40 to +85               | $^\circ\text{C}$ |
| Storage Temperature Range                  | -40 to +85                                   | -40 to +85               | $^\circ\text{C}$ |
| Soldering Temperature                      | See reflow soldering profile (Figure 9 & 10) |                          |                  |

### Absolute Maximum Ratings for AlGaAs at $T_A=25^\circ\text{C}$

| Parameter                                  | C110/150                                     | C120/170/190/191/265 | Units            |
|--|--|----------------------|------------------|
| DC Forward Current <sup>[1]</sup>          | 30   | 25                   | mA               |
| Power Dissipation                          | 78   | 65                   | mW               |
| Reverse Voltage ( $I_R=100\ \mu\text{A}$ ) | 5  | 5                    | V                |
| LED Junction Temperature                   | 95   | 95                   | $^\circ\text{C}$ |
| Operating Temperature Range                | -40 to +85                                   | -40 to +85           | $^\circ\text{C}$ |
| Storage Temperature Range                  | -40 to +85                                   | -40 to +85           | $^\circ\text{C}$ |
| Soldering Temperature                      | See reflow soldering profile (Figure 9 & 10) |                      |                  |

**Note:**

1. Derate linearly as shown in Figure 4 for temperature above  $25^\circ\text{C}$ .

### Electrical Characteristics at $T_A=25^\circ\text{C}$

| Part Number   | Color  | Forward Voltage<br>$V_F$ (Volts)<br>@ $I_F = 20\ \text{mA}$ |      | Reverse<br>Breakdown<br>$V_R$ (Volts)<br>@ $I_R = 100\ \mu\text{A}$ | Capacitance<br>$C$ (pF),<br>@ $V_F = 0\ \text{V}$ ,<br>$f = 1\ \text{MHz}$ | Thermal<br>Resistance<br>$R_{\theta J-P}$ ( $^\circ\text{C}/\text{W}$ ) |
|---|--------|---|------|---|--|---|
|   |        | Typ.  | Max. | Min.  | Typ.   | Typ.  |
|   |        | HSMS-C110/150<br>HSMS-C120<br>HSMS-C170/177/190/191/197     | HER  | 2.1   | 2.6  | 5   |
| HSMD-C110/150<br>HSMD-C120<br>HSMD-C170/177/190/191/197     | Orange | 2.2   | 2.6  | 5   | 7  | 400<br>350<br>250   |
| HSMY-C110/150<br>HSMY-C170/177/190/191/197                  | Yellow | 2.1   | 2.6  | 5   | 6  | 400<br>250  |
| HSMG-C110/150<br>HSMG-C120<br>HSMG-C170/177/190/191/197/265 | Green  | 2.2   | 2.6  | 5   | 9  | 400<br>350<br>250   |
| HSMH-C110/150<br>HSMH-C120<br>HSMH-C170/190/191/265         | AlGaAs | 1.8   | 2.6  | 5   | 18   | 460<br>400<br>300   |

## Optical Characteristics at $T_A=25^\circ\text{C}$

| Part Number               | Color  | Luminous Intensity <sup>[1]</sup><br>I <sub>v</sub> (mcd)@20mA |      | Peak Wavelength<br>$\lambda_{\text{peak}}$ (nm) | Dominant Wavelength<br>$\lambda_d$ (nm) | Viewing Angle $2\theta_{1/2}$ (°) <sup>[2]</sup> |
|---------------------------|--------|--|------|---|---|--|
|                           |        | Min.   | Typ. | Typ.  | Typ.                                    | Typ.   |
| HSMG-C110/177/197         | Green  | 4.5  | 15.0 | 570   | 572                                     | 130  |
| HSMG-C120                 |        |  |      |   |   | 155  |
| HSMG-C150/170/190/191/265 |        |  |      |   |   | 170  |
| HSMS-C110/177/197         | HER    | 2.8  | 10.0 | 630   | 626                                     | 130  |
| HSMS-C120                 |        |  |      |   |   | 155  |
| HSMS-C150/170/190/191     |        |  |      |   |   | 170  |
| HSMD-C110/177/197         | Orange | 2.8  | 8.0  | 605   | 604                                     | 130  |
| HSMD-C120                 |        |  |      |   |   | 155  |
| HSMD-C150/170/190/191     |        |  |      |   |   | 170  |
| HSMY-C110/177/197         | Yellow | 2.8  | 8.0  | 589   | 586                                     | 130  |
| HSMY-C150/170/190/191     |        |  |      |   |   | 170  |
| HSMH-C110                 | AlGaAs | 7.2  | 17.0 | 660   | 639                                     | 130  |
| HSMH-C120                 |        |  |      |   |   | 155  |
| HSMH-C150/170/190/191/265 |        |  |      |   |   | 170  |

### Notes:

1. The luminous intensity, I<sub>v</sub>, is measured at the peak of the spatial radiation pattern, which may not be aligned with the mechanical axis of the lamp package.
2.  $\theta_{1/2}$  is the off-axis angle where the luminous intensity is 1/2 the peak intensity.

## Color Bin Limits<sup>[1]</sup>

### Green Color Bins<sup>[1]</sup>

| Bin ID | Dom. Wavelength (nm) |       |
|--------|----------------------|-------|
|        | Min.                 | Max.  |
| A      | 561.5                | 564.5 |
| B      | 564.5                | 567.5 |
| C      | 567.5                | 570.5 |
| D      | 570.5                | 573.5 |
| E      | 573.5                | 576.5 |

Tolerance:  $\pm 1$  nm

### Yellow Color Bins<sup>[1]</sup>

| Bin ID | Dom. Wavelength (nm) |       |
|--------|----------------------|-------|
|        | Min.                 | Max.  |
| A      | 582.0                | 584.5 |
| B      | 584.5                | 587.0 |
| C      | 587.0                | 589.5 |
| D      | 589.5                | 592.0 |
| E      | 592.0                | 594.5 |
| F      | 594.5                | 597.0 |

Tolerance:  $\pm 1$  nm

### Orange Color Bins<sup>[1]</sup>

| Bin ID | Dom. Wavelength (nm) |       |
|--------|----------------------|-------|
|        | Min.                 | Max.  |
| A      | 597.0                | 600.0 |
| B      | 600.0                | 603.0 |
| C      | 603.0                | 606.0 |
| D      | 606.0                | 609.0 |
| E      | 609.0                | 612.0 |
| F      | 612.0                | 615.0 |

Tolerance:  $\pm 1$  nm

### Light Intensity (Iv) Bin Limits<sup>[1]</sup>

| Bin ID | Intensity (mcd) |       | Bin ID | Intensity (mcd) |         |
|--------|-----------------|-------|--------|-----------------|---------|
|        | Min.            | Max.  |        | Min.            | Max.    |
| A      | 0.11            | 0.18  | N      | 28.50           | 45.00   |
| B      | 0.18            | 0.29  | P      | 45.00           | 71.50   |
| C      | 0.29            | 0.45  | Q      | 71.50           | 112.50  |
| D      | 0.45            | 0.72  | R      | 112.50          | 180.00  |
| E      | 0.72            | 1.10  | S      | 180.00          | 285.00  |
| F      | 1.10            | 1.80  | T      | 285.00          | 450.00  |
| G      | 1.80            | 2.80  | U      | 450.00          | 715.00  |
| H      | 2.80            | 4.50  | V      | 715.00          | 1125.00 |
| J      | 4.50            | 7.20  | W      | 1125.00         | 1800.00 |
| K      | 7.20            | 11.20 | X      | 1800.00         | 2850.00 |
| L      | 11.20           | 18.00 | Y      | 2850.00         | 4500.00 |
| M      | 18.00           | 28.50 |        |                 |         |

Tolerance:  $\pm 15\%$

**Note:**

1. Bin categories are established for classification of products. Products may not be available in all categories. Please contact your Avago representative for information on currently available bins.
2. The Iv binning specification set-up is for lowest allowable Iv binning only. There is no upper Iv bin limits.

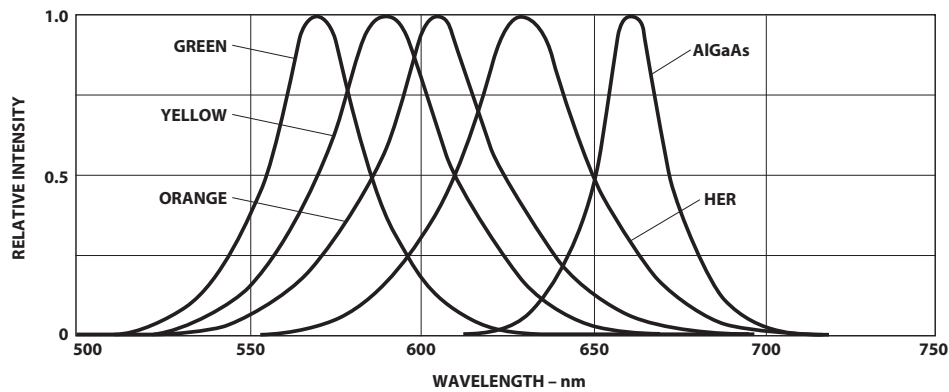

Figure 1. Relative intensity vs. wavelength.

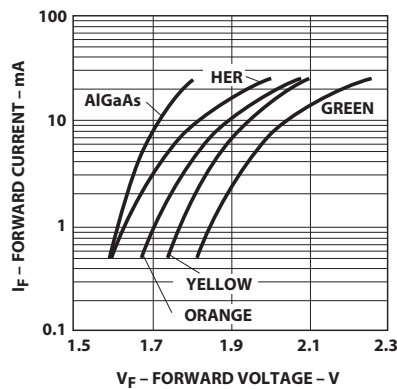

Figure 2. Forward current vs. forward voltage.

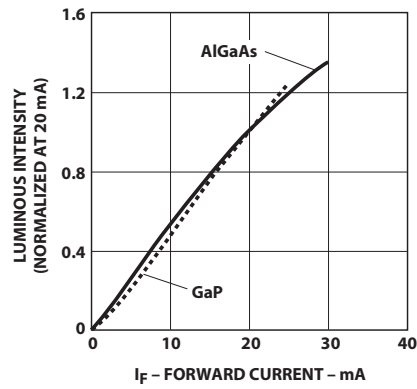

Figure 3. Luminous intensity vs. forward current.

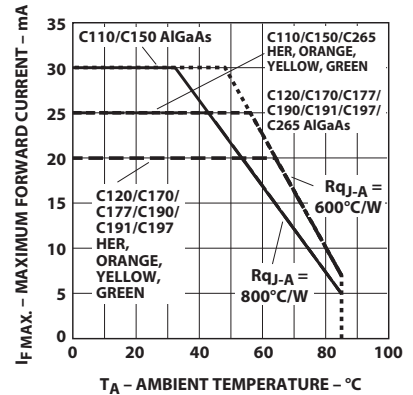

Figure 4. Maximum forward current vs. ambient temperature.

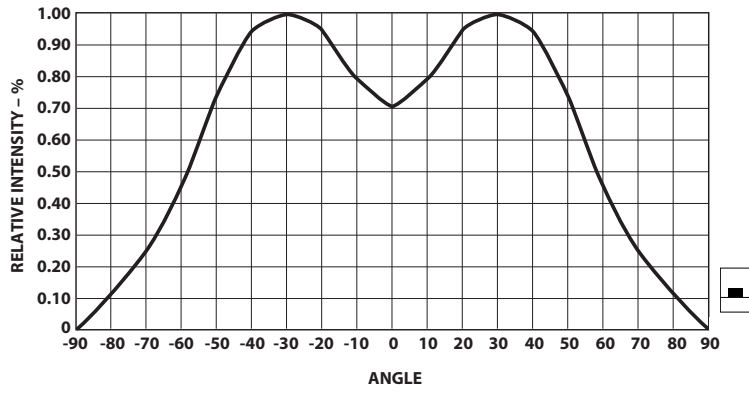
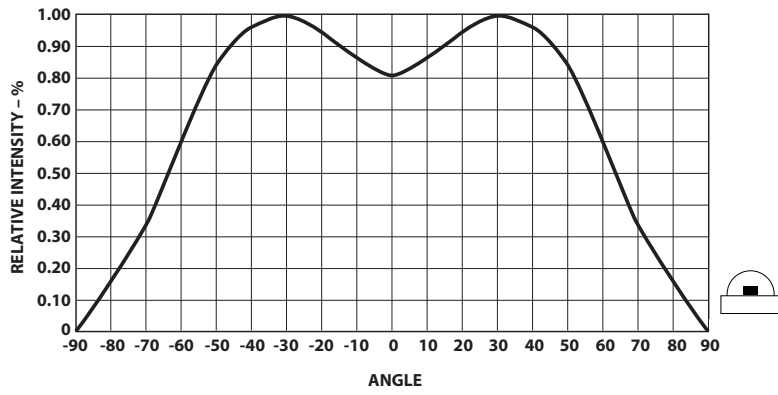

Figure 5. Relative intensity vs. angle for HSMx-C110.

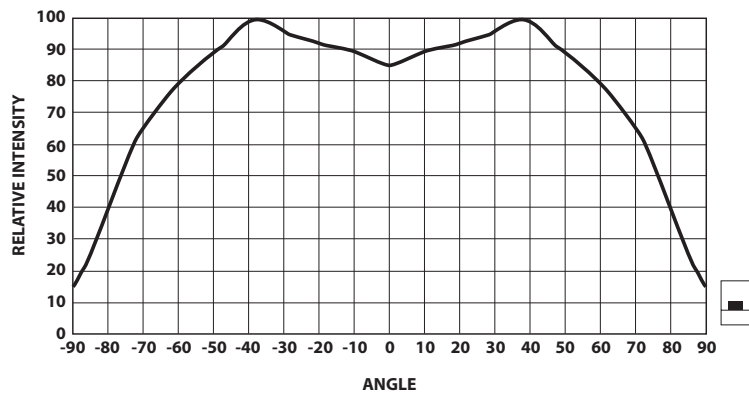
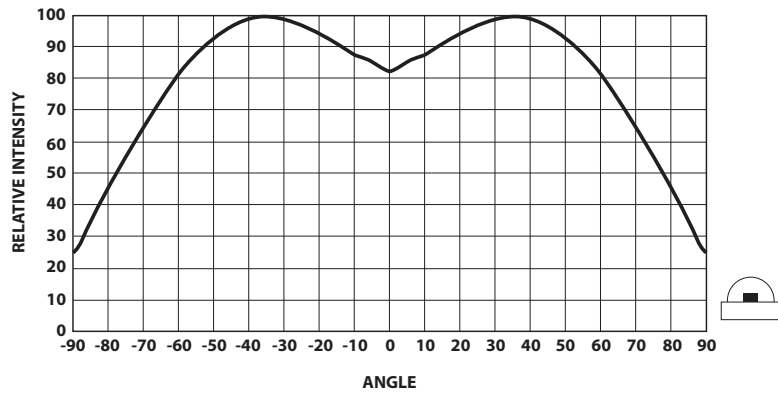

Figure 6. Relative intensity vs. angle for HSMx-C120.



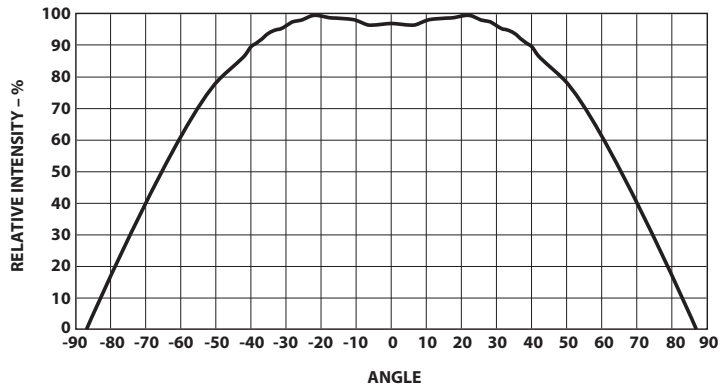

Figure 7. Relative intensity vs. angle for HSMx-C177 and C197.

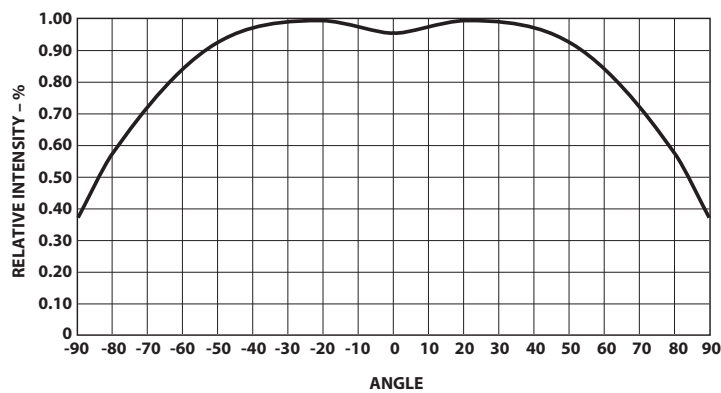

Figure 8. Relative intensity vs. angle for HSMx-C150, C170, C190, C191 and C265.

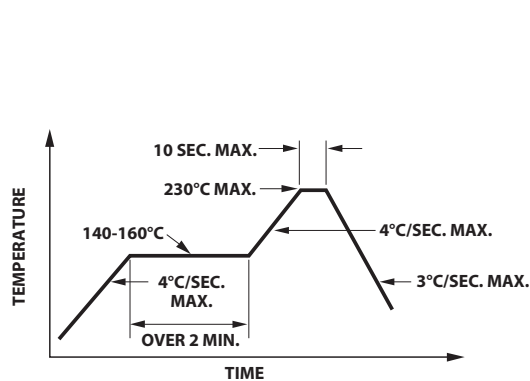

Figure 9. Recommended reflow soldering profile.

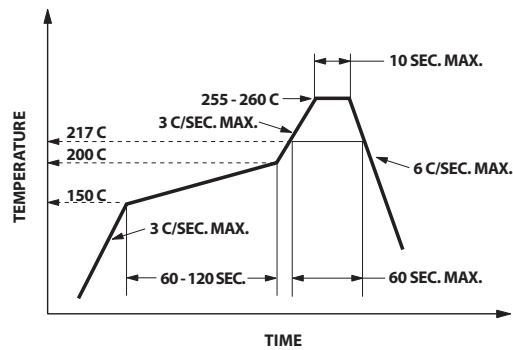

Figure 10. Recommended Pb-free reflow soldering profile.

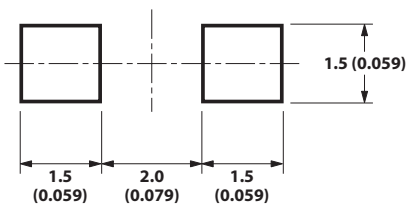

Figure 11. Recommended soldering pattern for HSMx-C150.

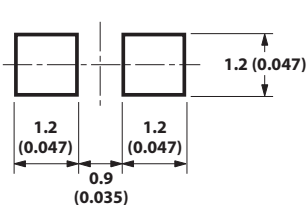

Figure 12. Recommended soldering pattern for HSMx-C170 and C177.

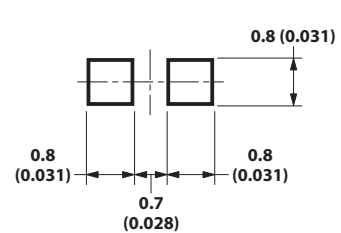

Figure 13. Recommended soldering pattern for HSMx-C190, C191 and C197.

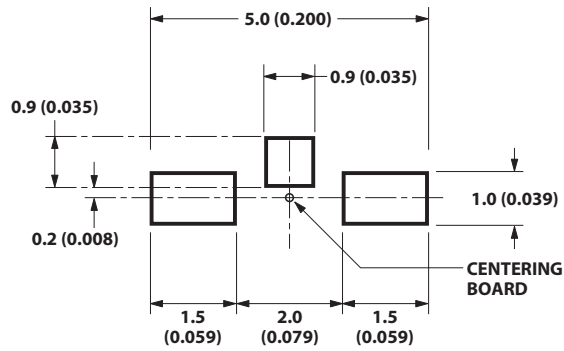

Figure 14. Recommended soldering pattern for HSMx-C110.

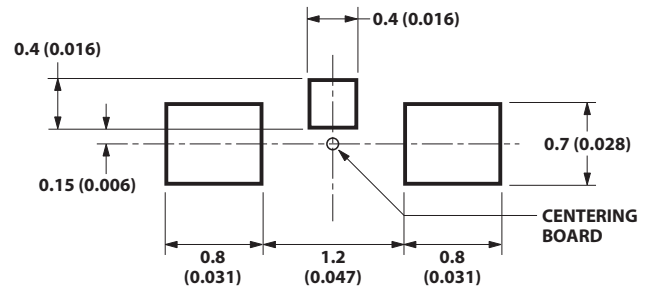

Figure 15. Recommended soldering pattern for HSMx-C120.

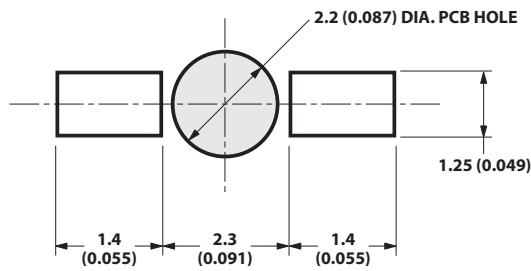

Figure 16. Recommended soldering pattern for HSMx-C265.

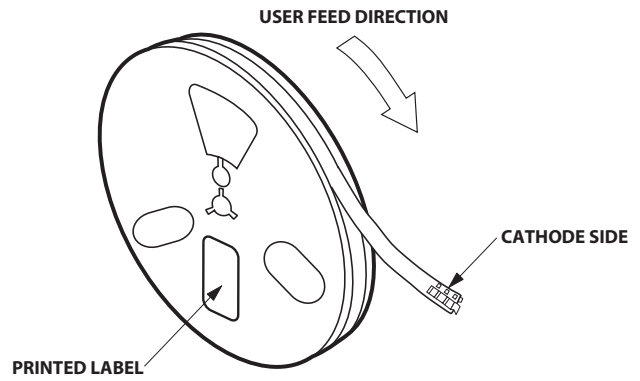

Figure 17. Reeling orientation.

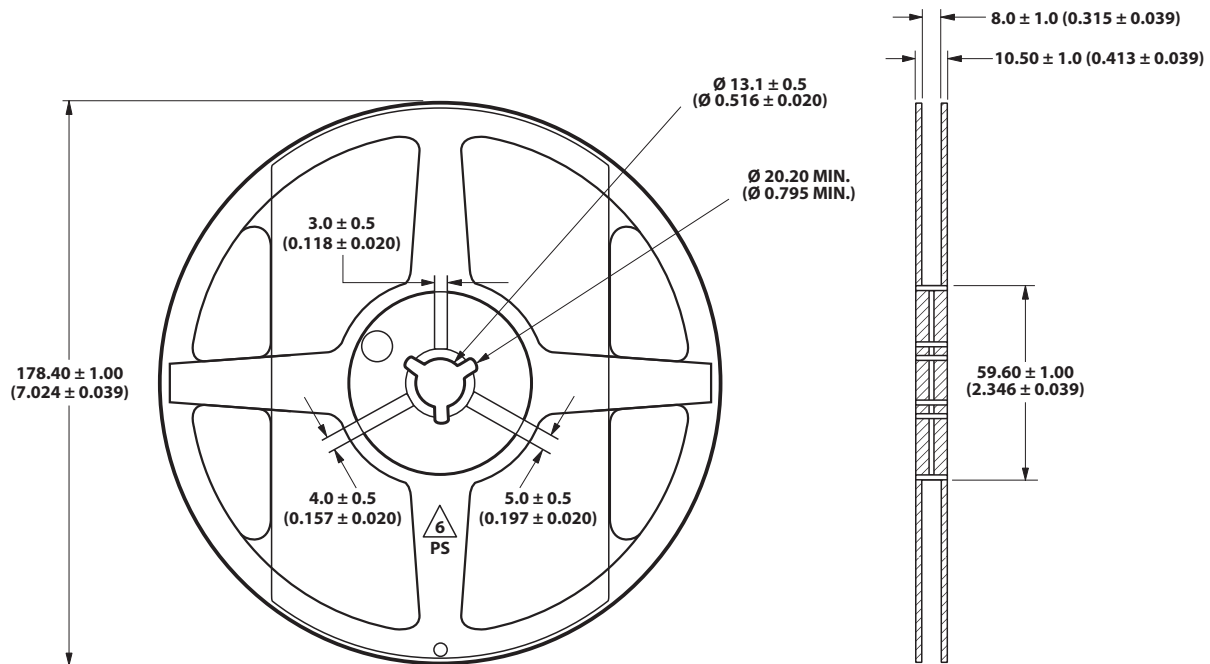

Figure 18. Reel dimensions.

Note: All dimensions in millimeters (inches).

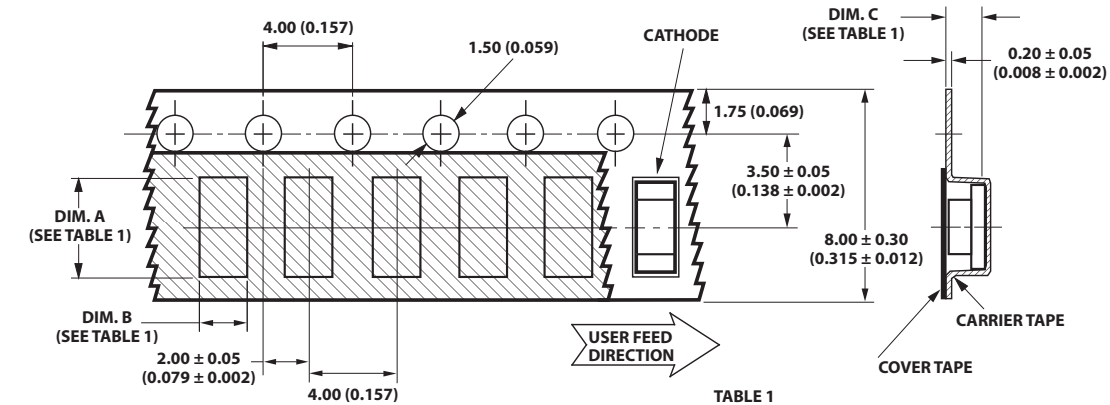

TABLE 1  
DIMENSIONS IN MILLIMETERS (INCHES)

| PART NUMBER      | DIM. A<br>± 0.10 (0.004) | DIM. B<br>± 0.10 (0.004) | DIM. C<br>± 0.10 (0.004) |
|------------------|--------------------------|--------------------------|--------------------------|
| HSMx-C110 SERIES | 3.40 (0.134)             | 1.70 (0.067)             | 1.20 (0.047)             |
| HSMx-C120 SERIES | 1.90 (0.075)             | 1.15 (0.045)             | 0.75 (0.030)             |
| HSMx-C150 SERIES | 3.50 (0.138)             | 1.88 (0.074)             | 1.27 (0.050)             |
| HSMx-C170 SERIES | 2.30 (0.091)             | 1.45 (0.057)             | 0.95 (0.037)             |
| HSMx-C177 SERIES | 2.30 (0.091)             | 1.40 (0.055)             | 0.60 (0.024)             |
| HSMx-C190 SERIES | 1.75 (0.069)             | 0.90 (0.035)             | 0.90 (0.035)             |
| HSMx-C191 SERIES | 1.86 (0.073)             | 0.89 (0.035)             | 0.87 (0.034)             |
| HSMx-C197 SERIES | 1.75 (0.069)             | 0.95 (0.037)             | 0.60 (0.024)             |

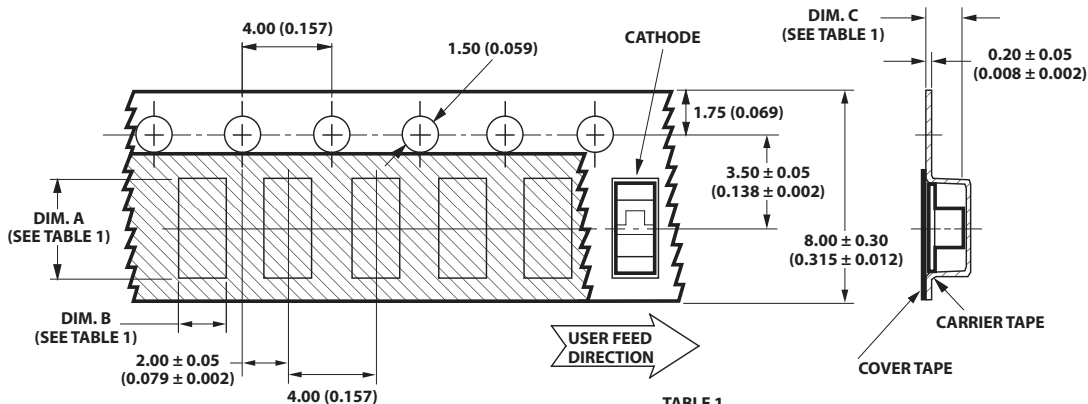
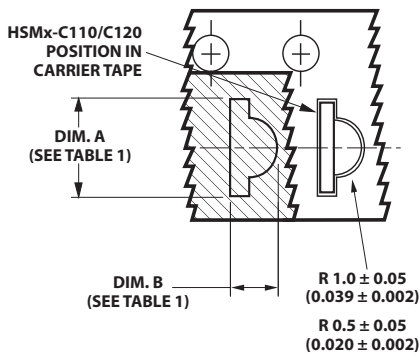

TABLE 1  
DIMENSIONS IN MILLIMETERS (INCHES)

| PART NUMBER      | DIM. A<br>± 0.10 (0.004) | DIM. B<br>± 0.10 (0.004) | DIM. C<br>± 0.10 (0.004) |
|------------------|--------------------------|--------------------------|--------------------------|
| HSMx-C265 SERIES | 3.70 (0.146)             | 1.45 (0.057)             | 1.30 (0.051)             |

Figure 19. Tape dimensions.

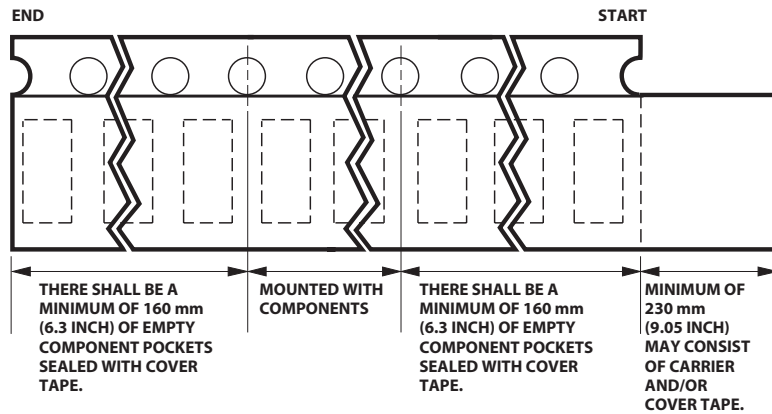

Figure 20. Tape leader and trailer dimensions.

**Notes:**

1. All dimensions in millimeters (inches).
2. Tolerance is  $\pm 0.1$  mm ( $\pm 0.004$  in.) unless otherwise specified.

Storage Condition: 5 to 30° C  
@ 60% RH max.

Baking is required under the condition:

- a) Humidity Indicator Card is >10% when read at  $23 \pm 5^\circ\text{C}$ .
- b) Device exposed to factory conditions <30°C/60% RH more than 672 hours.

Baking recommended condition: 60  
+/- 5°C for 20 hours.

**Convective IR Reflow Soldering**

For more information on IR reflow soldering, refer to Application Note 1060, *Surface Mounting SMT LED Indicator Components*.

For product information and a complete list of distributors, please go to our website: [www.avagotech.com](http://www.avagotech.com)

Avago, Avago Technologies, and the A logo are trademarks of Avago Technologies in the United States and other countries. Data subject to change. Copyright © 2005-2012 Avago Technologies. All rights reserved. Obsoletes 5989-4806EN AV02-0551EN - March 5, 2012

