

ERmet® Power Modules

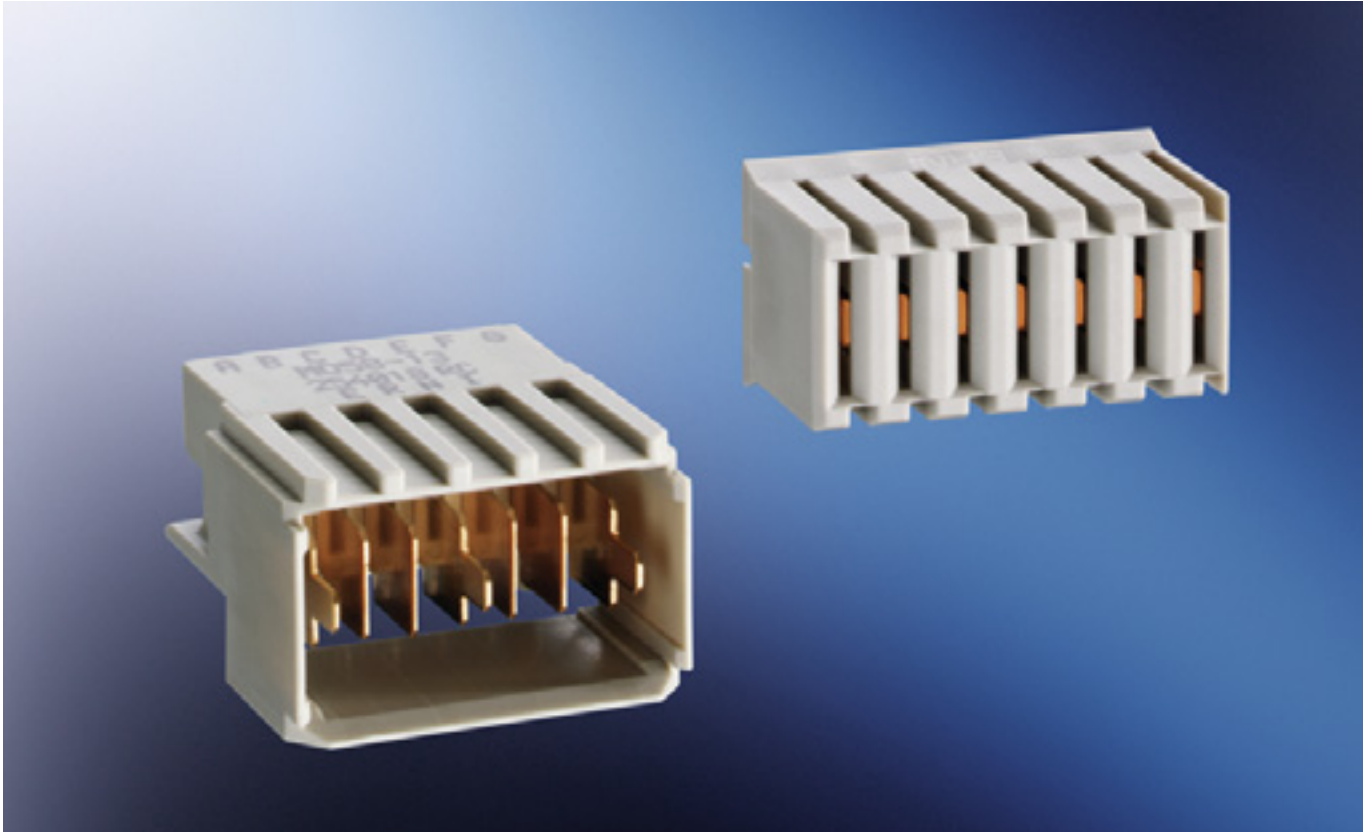



General2
Electrical and Mechanical Characteristics3
Derating Curve and PTH Drawing5
Right Angle Male6
Vertical Female12
Part Number Index15



ERNI Electronics has upgraded its hard metric Universal Power Module (UPM) to include new 5-, 6- and 7-pin versions. These UPMs expand the existing 3-pin power modules. They are offered in a high power grade which carries 12.6 A per contact (3-pin Version at 20 °C). Three contact mating length are available in 1.6 mm sequence levels.

These new high-performance connectors are designed to supply power applications in line with industry standard PICMG EXP.0 CompactPCI Express (5-pin and 7-pin versions). This completes the family of connectors supplied by ERNI in accordance with the CompactPCI Express standard, and meets requirements on both the signal side (ERmet ZD, ERmet type B8) and the power side.

The angled male multipoint connectors featuring pressfit technology are designed to supply power to daughter cards in conjunction with 2 mm ERmet connectors conforming to IEC 61076-4-101. Pre-mating contacts also make it possible to enable hot-swap applications. The corresponding straight female multipoint connectors are used on the backplanes. The UPMs are compatible with other 2 mm and DIN 41612 connectors, and also meet the requirements for performance class 1 and comply with RoHS.

	Standard	Male Power Module	Female Power Module
Number of Pins		3, 5, 6, 7	3, 5, 6, 7
Technical data			
Climate category	DIN EN 60068-1 test b	-55/125/56	-55/125/56
Temperature range		-55/125 °C	-55/125 °C
Current rating per contact	IEC 60512 test 5b	See page 5 for detailed Derating Curve.	
Air – and creepage distance		contact - contact 2.5 mm	contact - contact 2.5 mm
Voltage rating	IEC60664	The permissible operating voltages depend on the customer application and on the applicable or specified safety requirements. Insulation coordination according to IEC 60664-1 has to be regarded for the complete electrical device. Therefore, the maximum creepage and clearance distances of the mated connectors are specified for consideration as a part of the whole current path. In practice, reductions in creepage or clearance distances may occur due to the conductive pattern of the printed board or the wiring used, and have to be taken into account separately. As a result the creepage and clearance distances for the application may be reduced compared to those of the connector.	
Dielectric strength	IEC 60512 test 4a	contact – contact 1000 V _{rms}	contact – contact 1000 V _{rms}
Contact resistance	IEC 60512 test 2a	≤ 5 mΩ	≤ 5 mΩ
Insulation resistance	IEC 60512 test 3a	≥ 10 ⁴ MΩ	≥ 10 ⁴ MΩ
Vibration, sine	IEC 60512 test 6d	10 - 2000 Hz 20 g	10 - 2000 Hz 20 g
Contact disturbance (while vibration test)	IEC 60512 test 2e	≤ 1 μs	≤ 1 μs
Shock, halfsine	IEC 60512 test 6c	50 g 11 ms	50 g 11 ms
Contact disturbance (while shock test)	IEC 60512 test 2e	≤ 1μs	≤ 1μs
Mechanical operation (mating cycles)	IEC 60512 test 9a	> 250 mating cycles (3 pin) > 500 mating cycles (5, 6, 7 pin)	> 250 mating cycles > 500 mating cycles (5, 6, 7 pin)
Insertion and withdrawal force	IEC 60512 test 13a	≤ 6 N	≤ 6 N
Gauge retention force	IEC 60512 test 16e	≥ 0.2 N	≥ 0.2 N



	Standard	Male Power Module	Female Power Module
Number of Pins		3, 5, 6, 7	3, 5, 6, 7
Housing Materials			
Plastic material		PBT-GF30	PBT-GF30
CTI value	IEC 112	CTI 200	CTI 200
UL flame rating		UL 94 V-0	UL 94 V-0
Contact Materials			
Base material		Cu alloy	Cu alloy
Mating area		gold plated	gold plated
Termination area		Standard Versions: Sn CompactPCI Versions: SnPb (RoHS 5/6)	Standard Versions: Sn CompactPCI Versions: SnPb (RoHS 5/6)
Environment compatibility			
Recycling		no flame-retardent additives, no toxic additives allows easy recycling	
Product-approval			
UL		E84703	E84703

Derating Curve

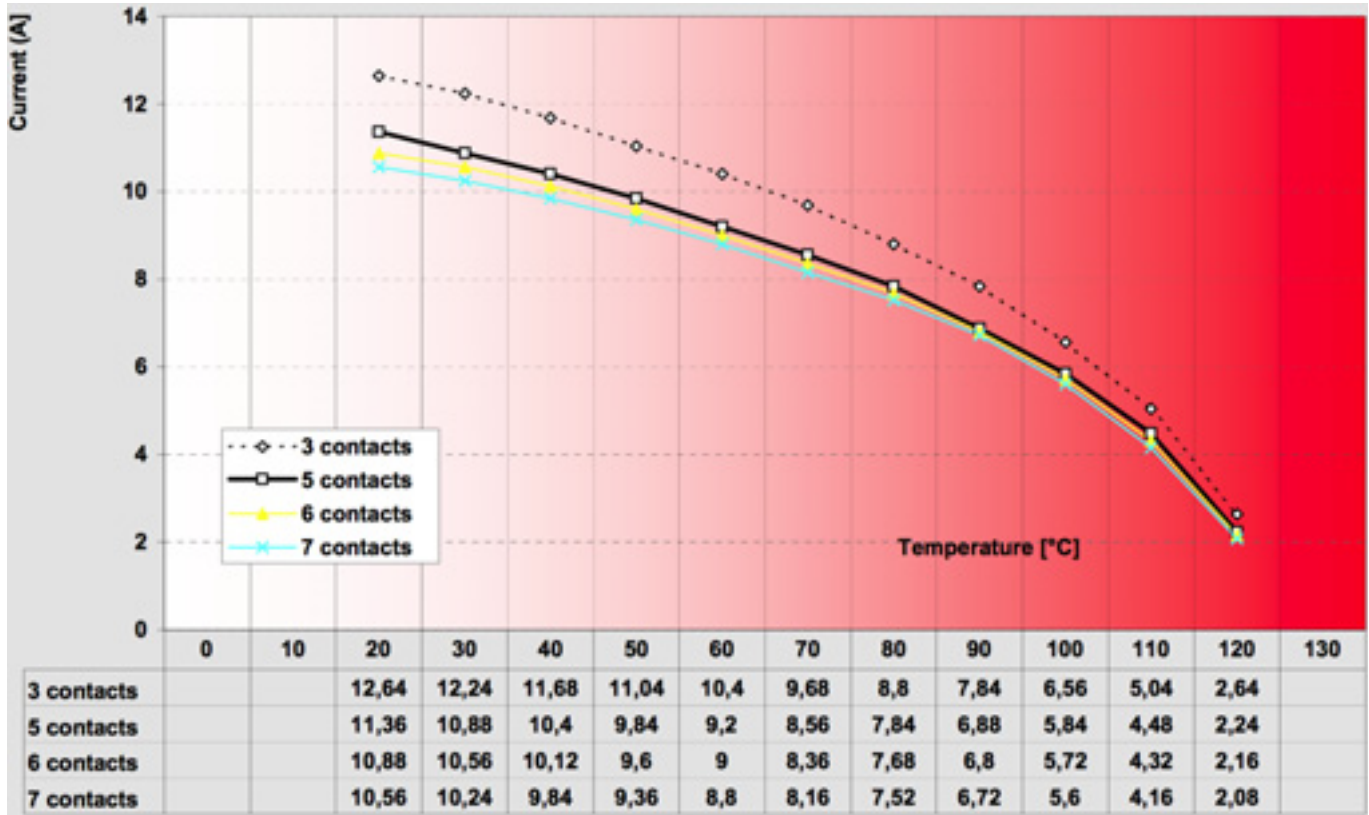

Metal Plating of Plated Through Hole

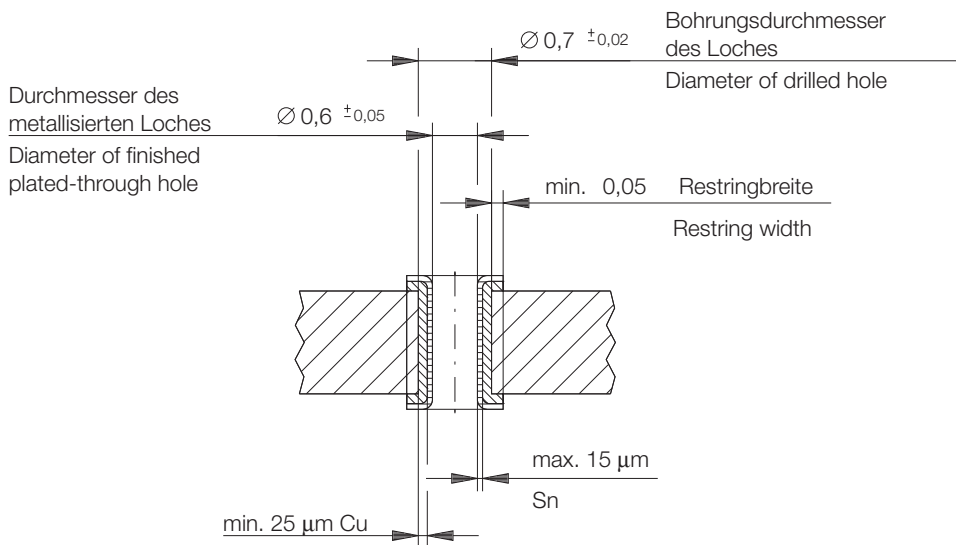



Dimensional Drawings

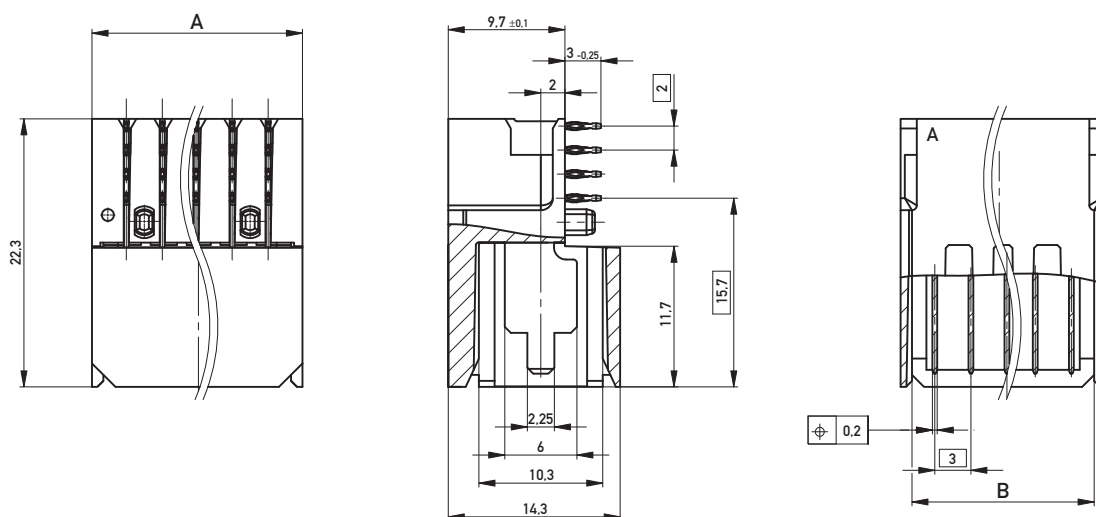

Lochbild für Leiterplatte
Board hole pattern

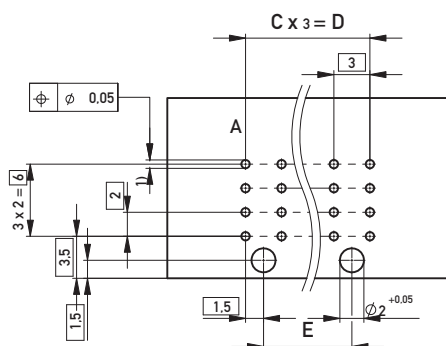

1) $\varnothing 0,6 \pm 0,05$ Durchmesser des metallisierten Loches
 $\varnothing 0,6 \pm 0,05$ Diameter of finished plated-through hole
 Schichtaufbau im metallisierten Loch siehe Zeichnung Seite 5
 Metal plating of plated-through hole see drawing page 5

A	11.7	17.7	20.7	23.7
B	9.8	15.8	18.8	21.8
C	2	4	5	6
D	6	12	15	18
E	3	9	12	15
Pinhzahl No of Pin	3	5	6	7

Kontaktübersicht/
contacts overview

L = lang / long
 M = mittel / middle
 S = kurz / short

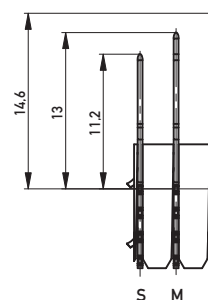

All dimensions in mm.

Ordering Information

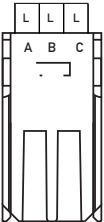
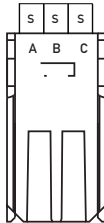
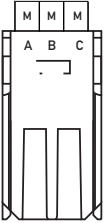
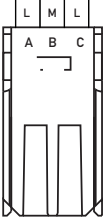
Configuration	No. of Pins	Current per contact	Termination	Class	Packaging	Part Number
	3	12.6 A	Pressfit	2	Tray/72 pcs	114400
	3	12.6 A	Pressfit	2	Tray/72 pcs	923539
	3	12.6 A	Pressfit	2	Tray/72 pcs	923619
	3	12.6 A	Pressfit	2	Tray/72 pcs	114401

Ordering Information

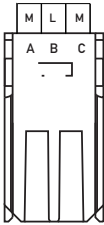
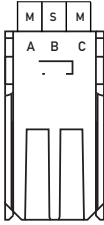
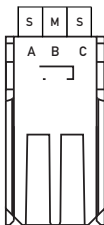
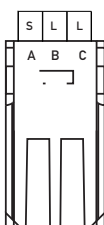
Configuration	No. of Pins	Current per contact	Termination	Class	Packaging	Part Number
	3	12.6 A	Pressfit	2	Tray/72 pcs	114402
	3	12.6 A	Pressfit	2	Tray/72 pcs	124163
	3	12.6 A	Pressfit	2	Tray/72 pcs	124298
	3	12.6 A	Pressfit	2	Tray/72 pcs	223531

Ordering Information

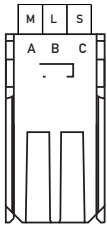
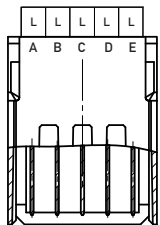
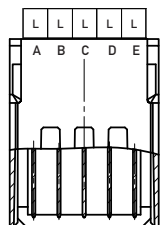
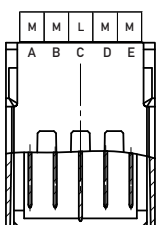
Configuration	No. of Pins	Current per contact	Termination	Class	Packaging	Part Number
	3	12.6 A	Pressfit	2	Tray/72 pcs	114403
	5	11.3 A	Pressfit	1	Tray/48 pcs	244997
	5	11.3 A	Pressfit	1*	Tray/48 pcs	244998
<i>CompactPCI® Express</i>						
	5	11.3 A	Pressfit	1	Tray/48 pcs	254988

* RoHS 5/6

Ordering Information

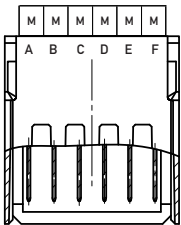
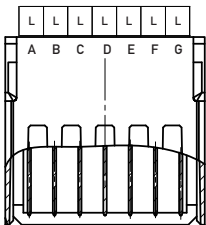
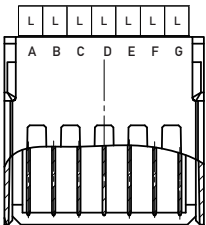
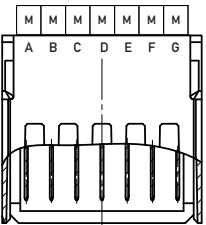
Configuration	No. of Pins	Current per contact	Termination	Class	Packaging	Part Number
	6	10.8 A	Pressfit	1	Tray/39 pcs	254963
	7	10.5 A	Pressfit	1	Tray/36 pcs	254020
	7	10.5 A	Pressfit	1*	Tray/36 pcs	254021
<i>CompactPCI® Express</i>						
	7	10.5 A	Pressfit	1	Tray/36 pcs	254992

* RoHS 5/6

ERmet® Power Modules

Right Angle Male



With Two Contact Levels	7	10.5 A	Pressfit	1	Tray/36 pcs	254018
-------------------------	---	--------	----------	---	-------------	---------------



Dimensional Drawings

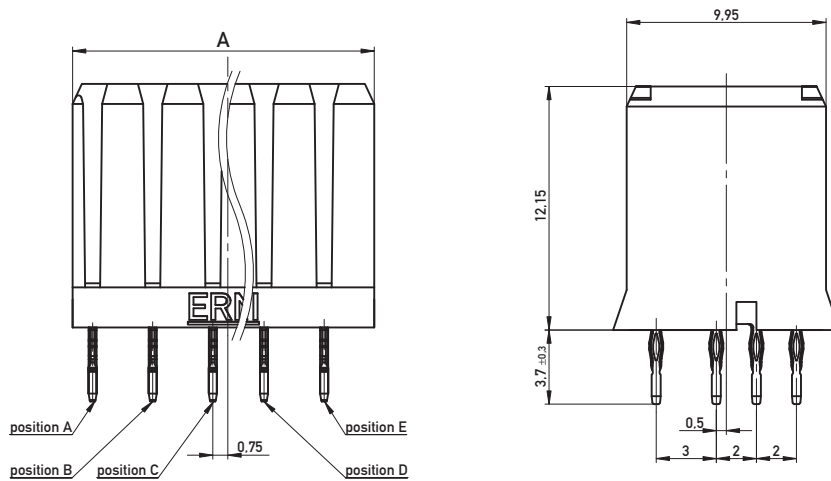

Lochbild für Leiterplatte
Board hole pattern

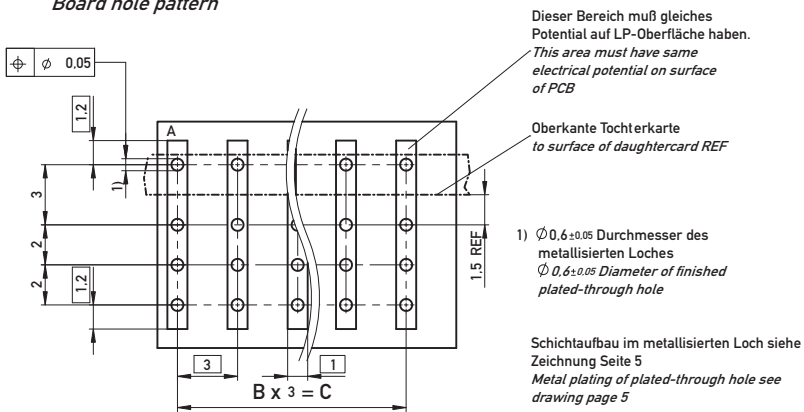

A	9,5	15,5	18,5	21,5
B	2	4	5	6
C	6	12	15	18
Pohlzahl No of Pin	3	5	6	7

All dimensions in mm.

Ordering Information

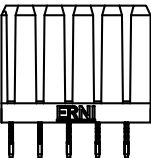
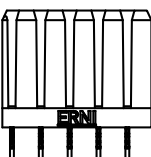
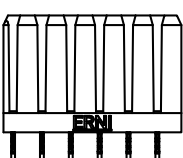
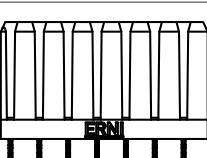
No. of Pins	Current per contact	Termination	Class	Packaging	Part Number
	12.6 A	Pressfit	2	Tray/150 pcs	114404
	11.3 A	Pressfit	1	Tray/90 pcs	244995
	11.3 A	Pressfit	1*	Tray/90 pcs	244996
<i>CompactPCI® Express</i>					
	10.8 A	Pressfit	1	Tray/75 pcs	254927
	10.5 A	Pressfit	1	Tray/65 pcs	254016

* RoHS 5/6



Ordering Information

Configuration	No. of Pins	Current per contact	Termination	Class	Packaging	Part Number
						
<i>CompactPCI® Express</i>						
7	10.5 A	Pressfit	1*		Tray/65 pcs	254017

* RoHS 5/6



Part Number	Page
114400	7
114401	7
114402	8
114403	9
114404	13
124163	8
124298	8
223531	8
244995	13
244996	13
244997	9
244998	9
254016	13
254017	14
254018	11
254019	11
254020	10
254021	10
254927	13
254963	10
254988	9
254992	10
923539	7
923619	7



Member



ERNI Electronics GmbH & Co. KG

Europe South America Africa Japan

Seestrasse 9
73099 Adelberg/Germany
Tel +49 7166 50-0
Fax +49 7166 50-282
info@erni.de

ERNI Electronics, Inc.

North America Canada Mexico

2201 Westwood Ave
Richmond, VA 23230/USA
Tel +1 804 228-4100
Fax +1 804 228-4099
info.usa@erni.com

ERNI Asia Holding Pte Ltd.

Asia Australia New Zealand

Blk 4008 Ang Mo Kio Avenue 10
#04-01/02 Techplace I
Singapore 569625
Tel +65 6 555 5885
Fax +65 6 555 5995
info@erni-asia.com

www.erni.com

© ERNI Electronics GmbH 2008 • Printed in Germany. A policy of continuous improvement is followed and the right to alter any published data without notice is reserved.
ERNI®, MicroStac®, MicroSpeed®, MiniBridge®, MaxiBridge®, ERmet®, ERmet ZD®, ERbic® and ERNIPRESS® are trademarks (registered or applied for in various countries) of ERNI Electronics GmbH. AdvancedTCA®, CompactPCI® and CompactPCI Express® are trademarks of PCI Industrial Computer Manufacturers Group.