

Alle Rechte vorbehalten/ All rights reserved

X
Kontaktanordnung
contact arrangement

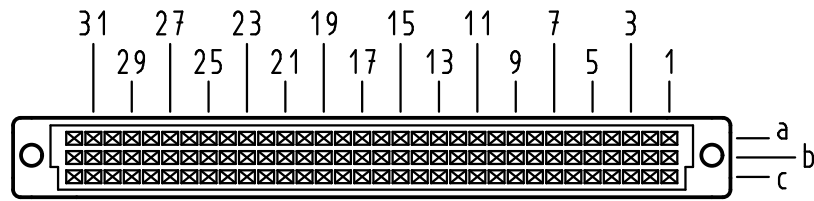

96 Einlöt-Kontakte
96 solder-contacts

- ☒ = Einlöt-Kontakt
= solder-contact
- = kinked Einlöt-Kontakt
= kinked solder-contact
- = Kontaktposition nicht belegt
= position without contact

X
(Lochbild)
(board drillings)

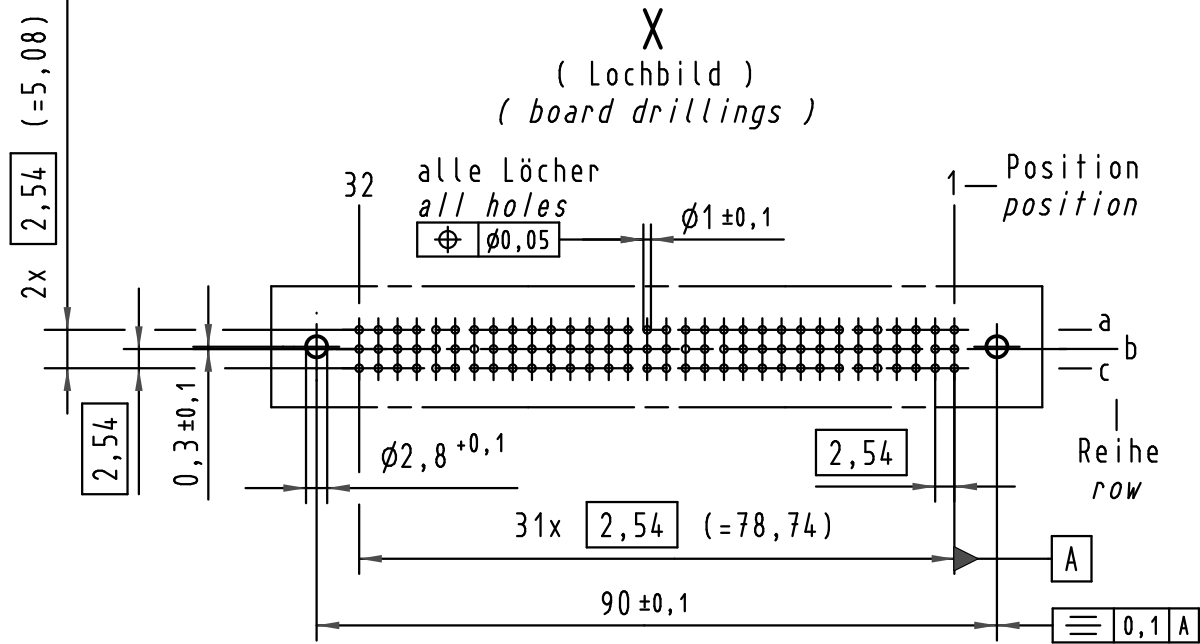

Z
2:1

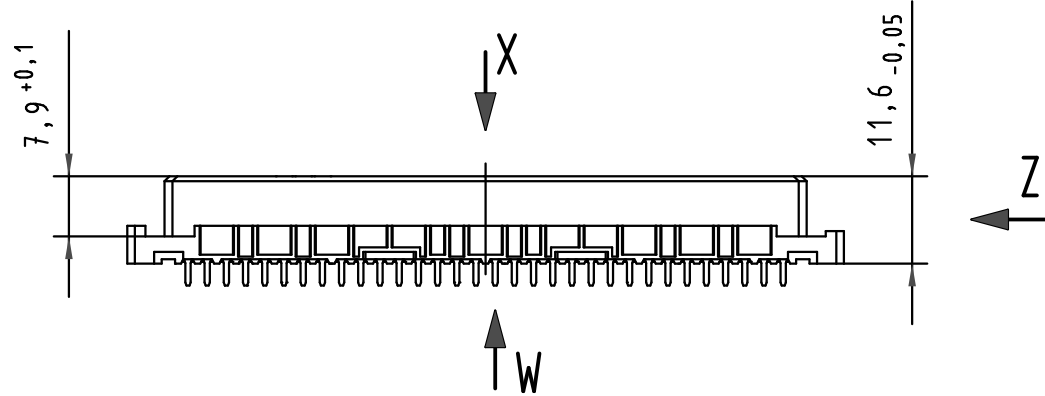
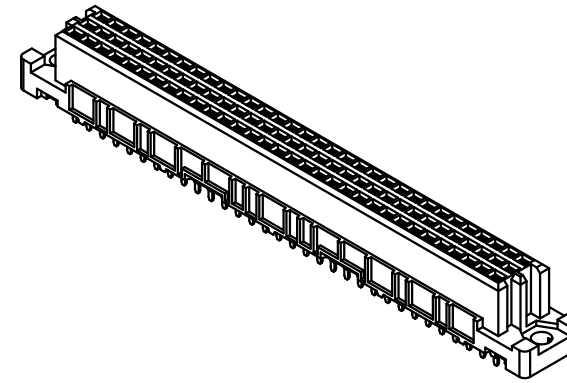
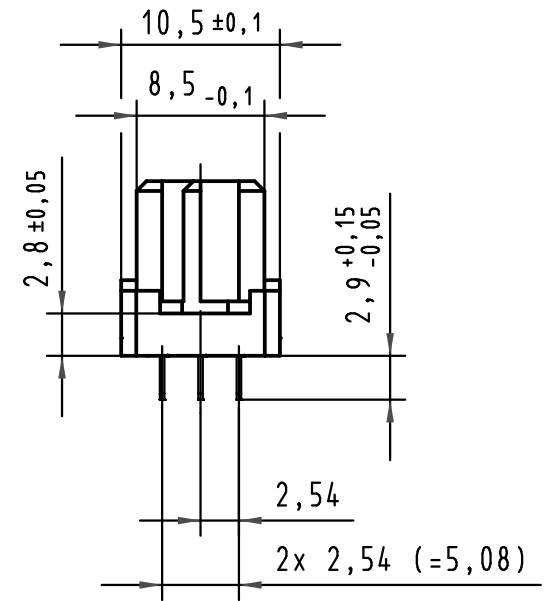

W
10:1
Querschnitt der
Lötanschlüsse:
cross-section of
solder terminations:

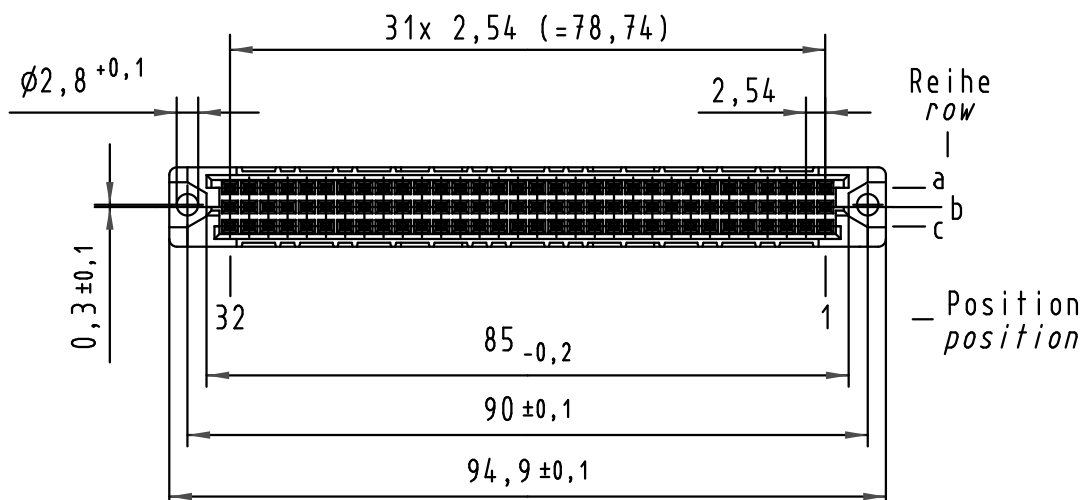
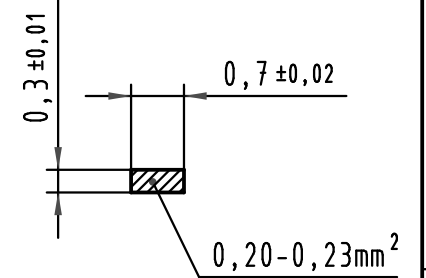

09 03 296 <u>7</u> 824	3	Au über/over Ni
09 03 296 <u>6</u> 824	2	Au über/over Ni
09 03 296 <u>2</u> 824	1	Au über/over Ni
Bestell-Nr. part-no.	Anforderungsstufe nach IEC performance level acc.to IEC	Kontaktoberfläche contact plating

All Dimensions in mm Original Size DIN A 3	Techn. Character.			Nicht tolerierte Maßel/Free size tolerances	
	IEC 60603-2			IEC 60603-2	
	Dat.	Name	Maßstab/Scale	har-bus C Federleiste Einlöt 2,9 , 96 pol. har-bus C female connector solder 2,9 , 96 pol.	
	Detail.	06.09.99 Rie.			
	Insp.	06.09.99 Pa.			
	Stand.				
34158	19.01.07	LehT	1:1 2:1	TB 09 03 296 x824	
30816	21.02.02	Rie.			
26083				Blatt/ page Sub.	
Mod.	Dat.	Name			
HARTING Electronics GmbH & Co. KG D-32339 ESPELKAMP					