

Alle Rechte vorbehalten. All rights reserved

**Y**  
(Lochbild)  
(board drillings)

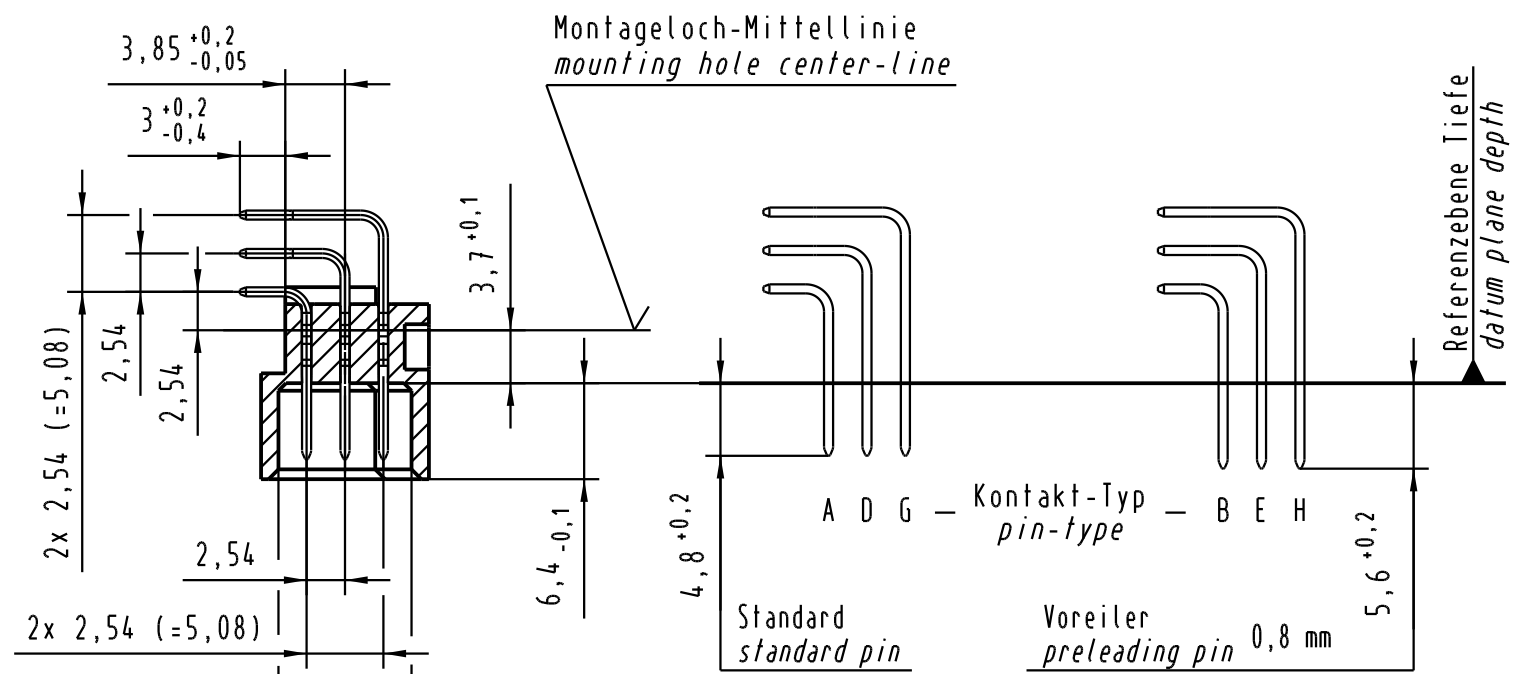
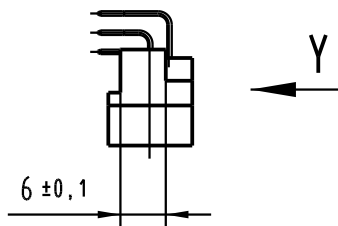
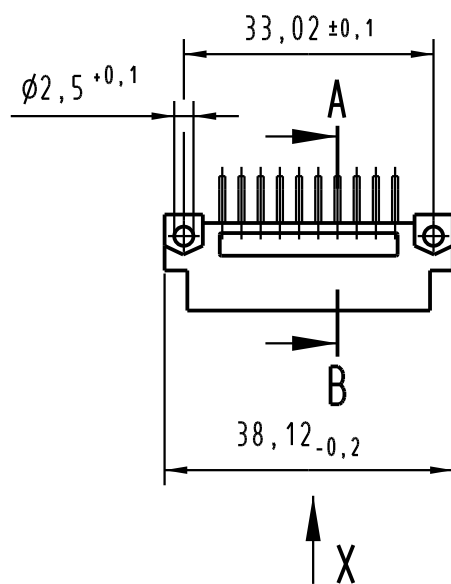
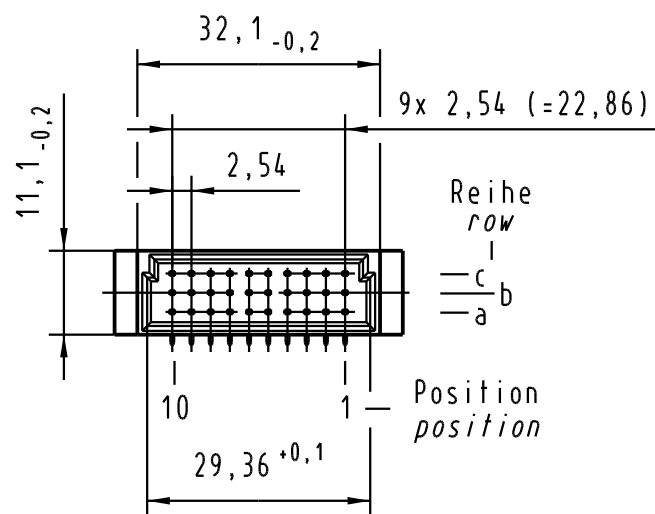
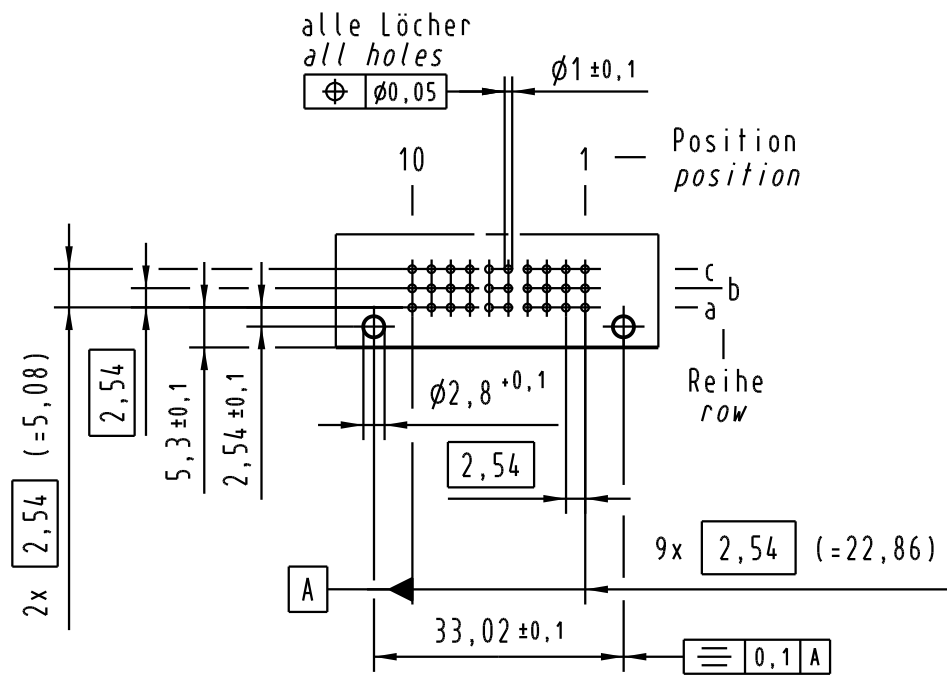

A-B  
2:1

**X** Kontaktbelegung  
contact loading

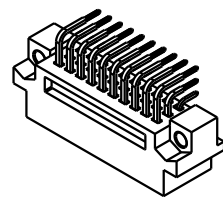
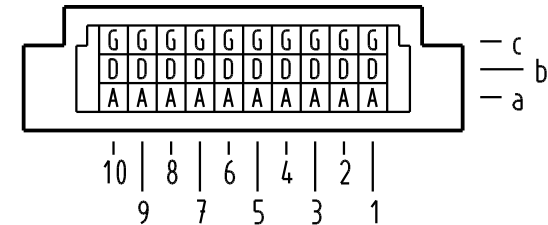

09 25 130 6921	2	Au über/over Ni
Bestell-Nr. part-no.	Anforderungsstufe nach IEC performance level acc. to IEC	Kontaktoberfläche contact plating

All Dimensions in mm Original Size DIN A 3			Techn. Character.			Nicht tolerierte Maßel Free size tolerances IEC 60603-2		
			Dat.	Name	Maßstab/Scale <b>1:1</b> (2:1)	Bauform 3C Messerleiste Einlöt, 30 pol. type 3C male connector solder, 30 pol.		
			Detail.	09.09.05 Hage.				
			Insp.	09.09.05 Sch.				
			Stand.					
33510	27.03.06	Leh.	HARTING Electronics GmbH & Co. KG			<b>TB 09 25 130 x921</b>		
31289			D-32339 ESPELKAMP					
Mod.	Dat.	Name				Blatt/page Sub.		