



WATERPROOF

Registered



ISO 9001

EDACON

an EDACOM company



an EDACOM company

40 Tiffield Road., Scarborough, Ontario, M1V 5B6, Canada
Telephone: (416) 754-3322 Facsimile: (416) 754-3299
e-mail: edac@edac.net Web Page: http://www.edac.net

Your Connection to Quality and Service

NUMERICAL INDEX	
Series	Page
556	8
566	2
566 Tools	7
568	6
568 Tools	7
570	4
570 Tools	7

TABLE OF CONTENTS	
Products	Page
Application Notes	1
Water Proof Connectors	5
Discrete wire Connectors	8

ENGINEERING NOTES:

The Waterproof series of connectors are made using the following materials and processes.

The insulator housing is made of high impact flame retardant (UL 94-V0) Polyester (PBT). The water seals are moulded out of silicone rubber. The housings use latching mechanisms to hold and lock the mating halves together.

The mated connectors have been tested for various levels of resistance to water ingress. These test vary from a level of "0" which means "without protection" to "8" which is a fully submersible connector.

The contacts are made of brass or phosphor bronze and are plated with nickel (to improve wear resistance and reduce galvanic corrosion), then they are plated with a tin-lead alloy for conductivity.

Crimp contacts are available for wire sizes of 28 to 22 AWG for the 566 series, and for 22 to 16 AWG for the 568 and 570 series.

APPLICATION NOTES:

The typical application of these connectors includes any place where there is the chance of water contaminating the circuit. These applications have included: bathrooms, hot water heaters, washing machines, water purifiers, outdoor motors, frozen food show cases, dishwashers and most outdoor applications.

The Waterproof connectors have been approved for use in environments which require a protection grade of "4" (Splash-Proof). The connectors have successfully passed testing to a protection grade of "7".

The following chart describes the protection grades, class descriptions, and meanings of the various moisture/water protection grades.

Protection Grade	Class Description	Meaning
0	-	No Moisture Protection
1	Drip-Proof Type I	No harmful influence by a drip of water falling perpendicularly.
2	Drip-Proof Type II	No harmful influence by a drip of water falling from a range covering 15 from perpendicular.
3	Spray-Proof	No harmful influence by a rainfall of water falling from a range covering 60 from perpendicular.
4	Splash-Proof	No harmful influence by a splash of water from any direction.
5	Jet-Proof	No harmful influence by a jet of water from any direction.
6	Watertight	No ingress of water inside by a jet of water from any direction.
7	Immersion-Proof	No ingress of water inside when immersed in water under specified conditions.
8	Submersible	Always useable when submerged in water of specified pressure.

Waterproof Standard descriptions Based on JIS C 0920-1993

The waterproof connectors are available in a wire-to-wire or a wire-to-board configuration. When used in a wire-to-board application, a silastic conformal coating may be used to seal the board mounted connector.

566 SERIES WATERPROOF CONNECTOR

Plug, Receptacle & Board Mount

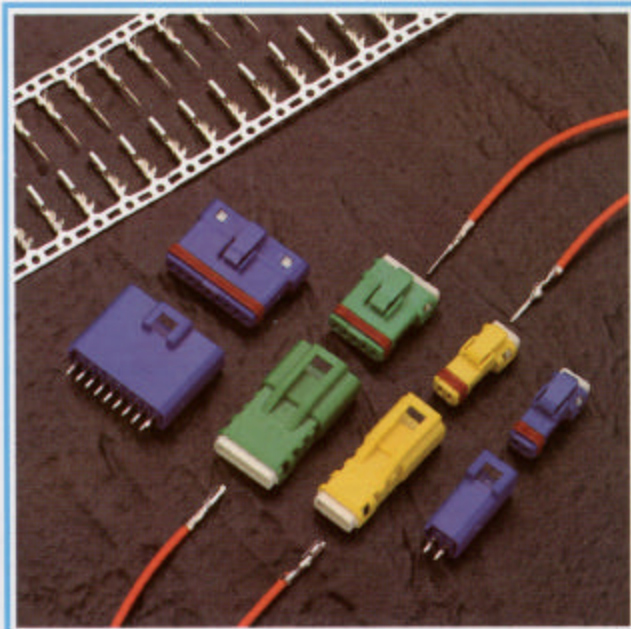

FEATURES

- Fully waterproof connector
- Plastic latch provides locking mechanism
- Plug and Receptacle in 1, 3, and 5 Contact positions
- Board mount style available in 2, 3, 5 and 9 contact positions
- Tools Available for Contact Installation, Removal and Crimping
- Able to carry current up to 2 A

SPECIFICATIONS

- Insulator Material: PBT (UL94V-0)
- Contact Material: PB / Tin plating
- Wire Housing Seal: Silicone Rubber
- Current Rating: 2 Amperes maximum
- Contact Resistance: 10m Ω Maximum
- Insulator Withstanding Voltage: 1000 V AC rms at Sea Level
- Insulation Resistance: 1000M Ω Minimum at 500 VDC
- Operating Temperature: -40 to +105 Degrees C
- Rated Voltage: 250 V
- Waterproof Grade 4
- Insulation diameter from .039" (1.0mm) to .059" (1.5mm) can be accommodated using different wire seals.

566 SERIES ORDERING CODE

Example Part Number **566 - 003 - 000 - 1 1 0**

Series _____
 Total Number of Contacts _____
 Contact Code _____
 Style _____
 Wire Diameter _____
 Termination _____

Series 566

Total Number of Contacts 002, 003, 005 or 009

Contact Code ^{1,2}

000 No Contacts Assembled
 420 Board Mount Contacts Installed

Style ³

1 Plug
 2 Receptacle

Wire Diameter ⁴

1 AWG 28 to 26
 Insulation Dia. .039" (1.0 mm) to .049" (1.25 mm)
 2 AWG 24 to 22
 Insulation Dia. .049" (1.25 mm) to .059" (1.5 mm)

Termination

0 Wire crimp terminals required
 1 PC Board Mount

Ordering Code Notes

1) Crimp contacts are available for the 566 series connectors. Contacts may be ordered separately for pre-wired or select position assembly.

Part Number	Description
566-290-711	Male contact
566-290-721	Female contact

2) For contact installation, removal and crimping tools, refer to page 7.

3) Insulator design prevents improper mating of individual plug and receptacle.

566 SERIES WATERPROOF CONNECTOR

Plug, Receptacle & Board Mount

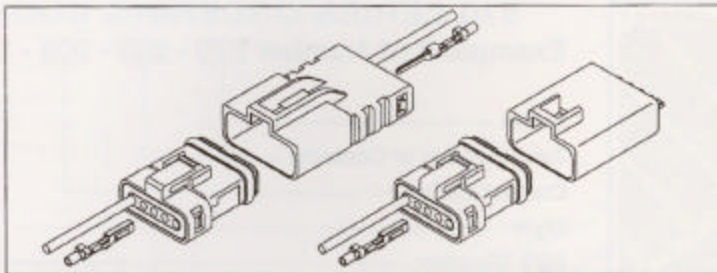

566-002-000-210 (SML GA)
566-002-000-220 (LRG GA)

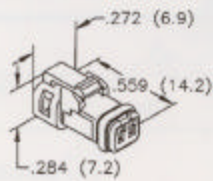

566-002-000-110 (SML GA)
566-002-000-120 (LRG GA)

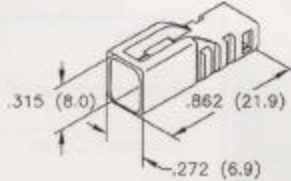

566-002-420-101

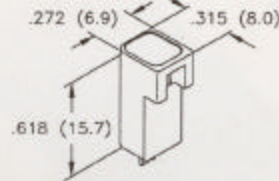

566-003-000-210 (SML GA)
566-003-000-220 (LRG GA)

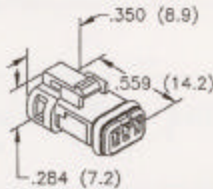

566-003-000-110 (SML GA)
566-003-000-120 (LRG GA)

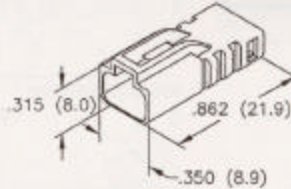

566-003-420-101

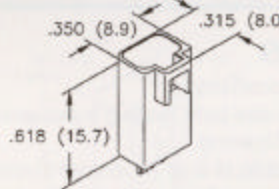

566-005-000-210 (SML GA)
566-005-000-220 (LRG GA)

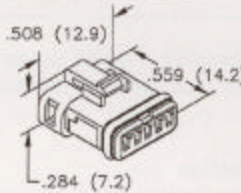

566-005-000-110 (SML GA)
566-005-000-120 (LRG GA)

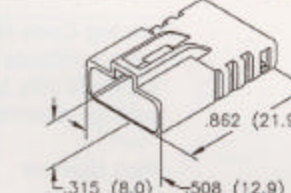

566-005-420-101

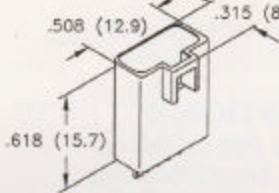

566-009-000-210 (SML GA)
566-009-000-220 (LRG GA)

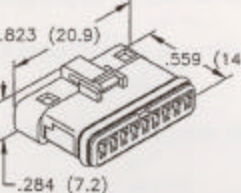

ASSEMBLY LAYOUT

- ① RETAINER
- ② WIRE SEAL
- ③ F TERMINAL
- ④ 566-NNN-000-210/220
- ⑤ HOUSING SEAL
- ⑥ M TERMINAL
- ⑦ 566-NNN-000-110/120
- ⑧ 566-NNN-000-101

566-009-420-101

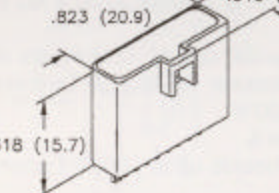

F TERMINAL M TERMINAL

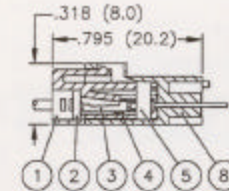
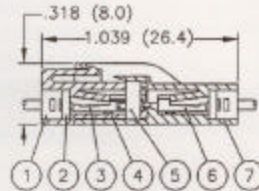
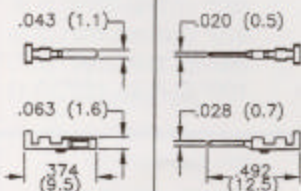

570 SERIES WATERPROOF CONNECTOR

Plug, Receptacle & Board Mount

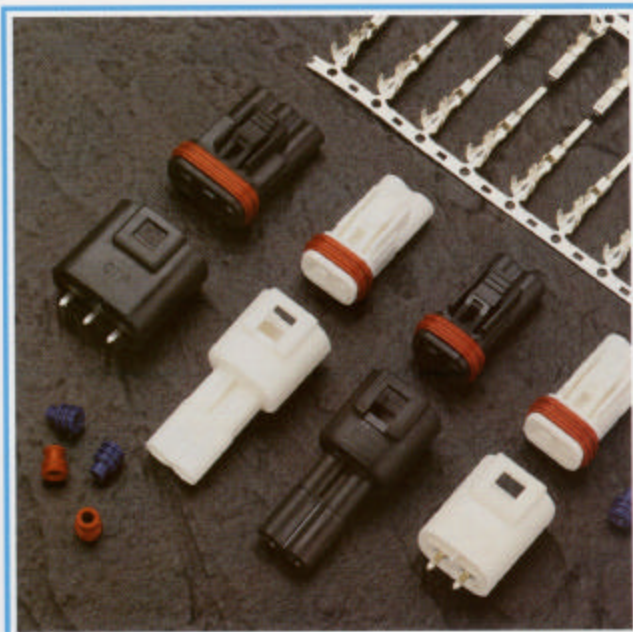

FEATURES

- Fully waterproof connector
- Plastic latch provides both locking mechanism and polarity
- 5.8 mm Contact Spacing
- Plug and Receptacle in 2 or 3 Contact positions
- Board Mount Style available in 1, 2 or 3 contact positions
- Contact Termination Options include Crimp and P.C. Tail
- Tools Available for Contact Installation, Removal and Crimping
- Able to carry large current up to 10 A

SPECIFICATIONS

- Insulator Material: PBT (UL94V-0)
- Contact Material: Brass / Tin plating
- Wire Housing Seal: Silicone Rubber
- Current Rating: 10 Amperes maximum
- Contact Resistance: 10m Ω Maximum
- Insulator Withstanding Voltage: 1700 V AC rms at Sea Level
- Insulation Resistance: 1000M Ω Minimum at 500 VDC
- Operating Temperature: -40 to +105 Degrees C
- Rated Voltage: 300 V
- Waterproof Grade 4
- For use with PC boards up to (.063") 1.6mm

570 SERIES ORDERING CODE

Example Part Number **570 - 003 - 000 - 1 0 0**

Series _____
 Total Number of Contacts _____
 Contact Code _____
 Style _____
 Wire Diameter _____
 Termination _____

Series 570

Total Number of Contacts 001, 002 or 003

Contact Code ^{1,2}
 000 No Contacts Assembled
 420 Board Mount Contacts Installed

Style ³
 1 Plug
 2 Receptacle

Wire Diameter ⁴
 0 None installed; both contacts and water seals sold separately

Termination
 0 Wire crimp terminals required
 1 PC Board Mount

Ordering Code Notes

1) Crimp contacts are available for the 570 series connectors. Contacts may be ordered separately for pre-wired or select position assembly.

Part Number	Description
570-290-711	Male contact for smaller gauge wire
570-290-721	Female contact for smaller gauge wire
570-290-731	Male contact for larger gauge wire
570-290-741	Female contact for larger gauge wire

2) For contact installation, removal and crimping tools, refer to page 7.

3) Insulator design prevents improper mating of individual plug and receptacle.

4) Wire Seals are available as follows:

Part Number	Colour	Insulation Dia	Flange
570-260-001	Black	.067" (1.7) to .075" (1.9)	No
570-260-002	Blue	.079" (2.0) to .102" (2.6)	No
570-260-003	Blue	.083" (2.1) to .106" (2.7)	Yes
570-260-004	Brown	.106" (2.7) to .122" (3.1)	Yes

570 SERIES WATERPROOF CONNECTOR

Plug, Receptacle & Board Mount

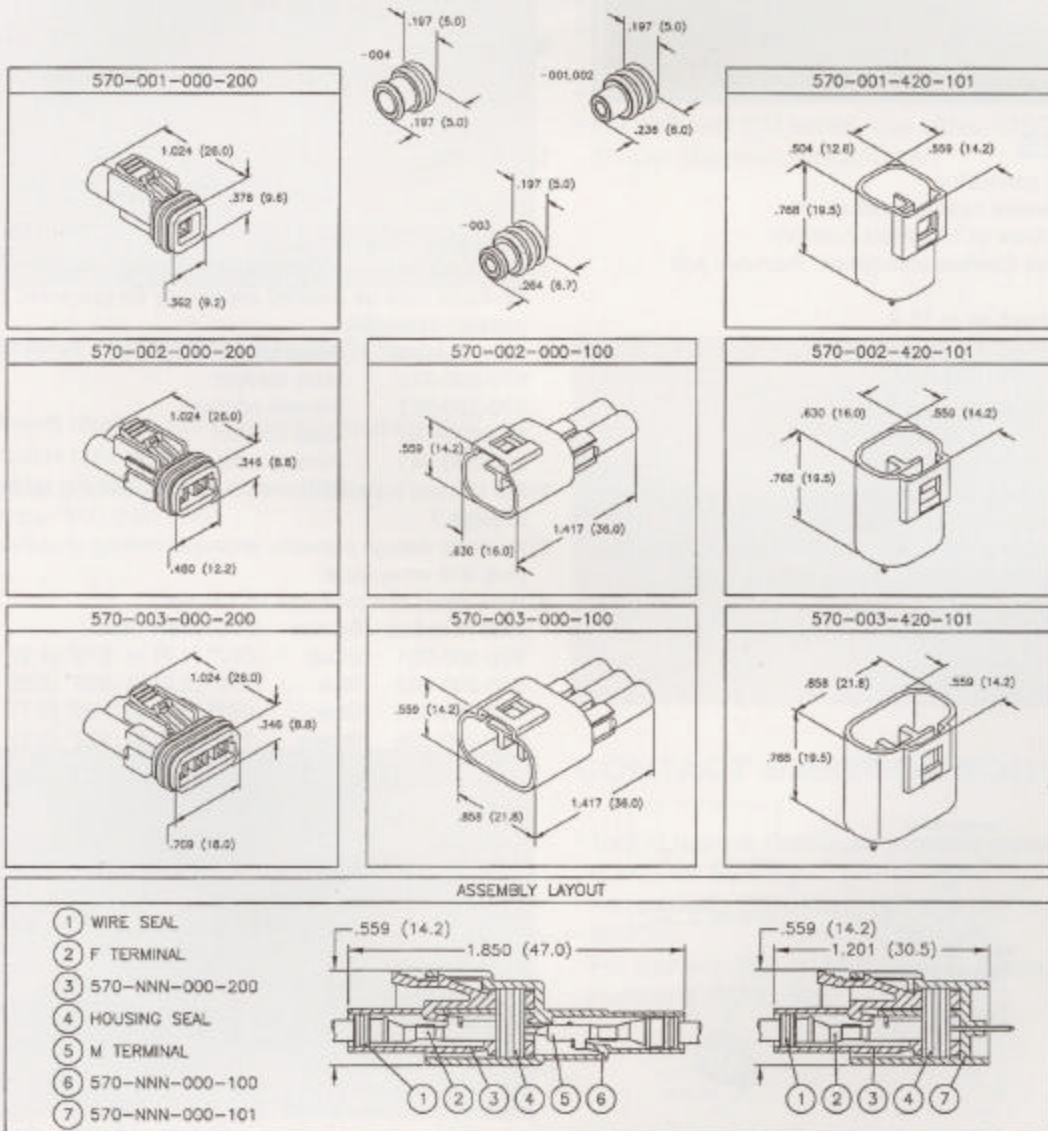
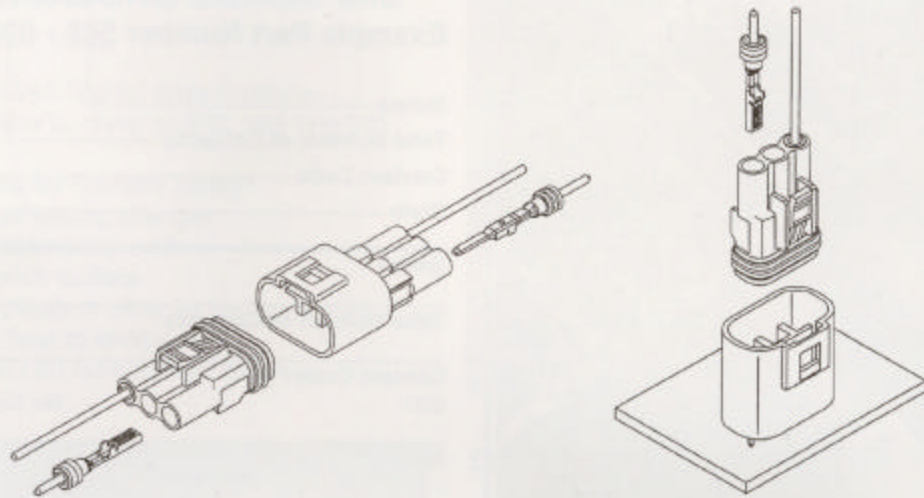

568 SERIES WATERPROOF CONNECTOR

Plug and Receptacle

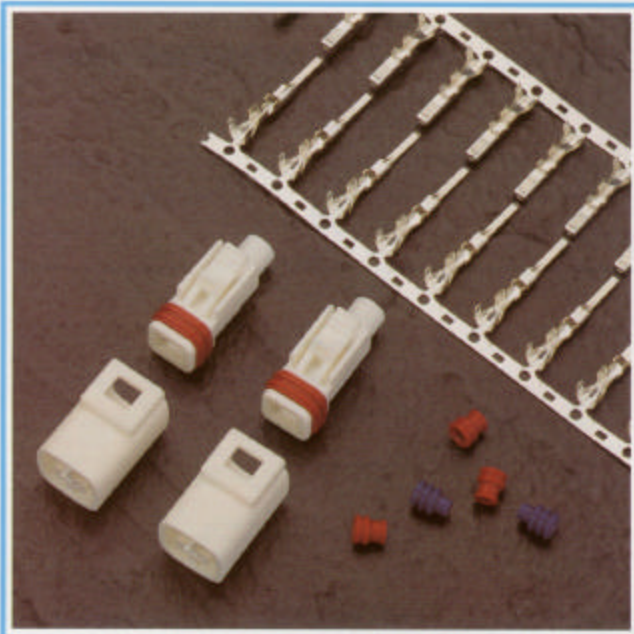

FEATURES

- Fully waterproof connector
- Plastic latch provides locking mechanism
- Plug and Receptacle in 1 Contact position
- Tools Available for Contact Installation, Removal and Crimping
- Able to carry current up to 15 A

SPECIFICATIONS

- Insulator Material: PBT (UL94V-0)
- Contact Material: Brass / Tin plating
- Wire Housing Seal: Silicone Rubber
- Current Rating: 15 Amperes maximum
- Contact Resistance: 10m Ω Maximum
- Insulator Withstanding Voltage: 1700 V AC rms at Sea Level
- Insulation Resistance: 1000M Ω Minimum at 500 VDC
- Operating Temperature: -40 to +105 Degrees C
- Rated Voltage: 300 V
- Waterproof Grade 4

568 SERIES ORDERING CODE

Example Part Number **568 - 001 - 000 - 100**

Series _____
 Total Number of Contacts _____
 Contact Code _____
 Style _____

Series	568
Total Number of Contacts	001
Contact Code ^{1,2}	No Contacts Assembled
Style ³	Plug Receptacle
Wire Diameter ⁴	None installed; both contacts and water seals sold separately

Termination
 0 Wire crimp terminals required

Ordering Code Notes

- 1) Crimp contacts are available for the 568 series connectors. Contacts may be ordered separately for pre-wired or select position assembly.

Part Number	Description
570-290-711	Male contact
570-290-721	Female contact
570-290-731	Male contact
570-290-741	Female contact

- 2) For contact installation, removal and crimping tools, refer to page 7.

- 3) Insulator design prevents improper mating of individual plug and receptacle.

- 4) Wire Seals are available as follows:

Part Number	Colour	Insulation Dia	Flange
570-260-001	Black	.067" (1.7) to .075" (1.9)	No
570-260-002	Blue	.079" (2.0) to .102" (2.6)	No
570-260-003	Blue	.083" (2.1) to .106" (2.7)	Yes
570-260-004	Brown	.106" (2.7) to .122" (3.1)	Yes

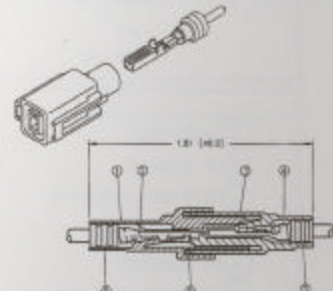
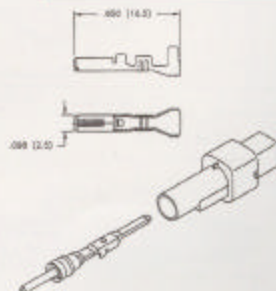
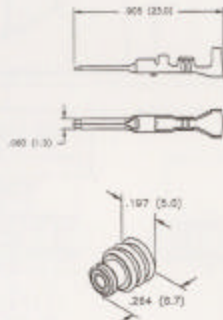
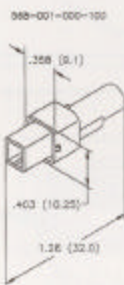
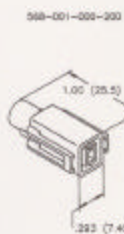

① 568-001-000-200 ② U TERMINAL ③ 568-001-000-100
 ④ F TERMINAL ⑤ WIRE SEAL ⑥ HOUSING SEAL

Tools for 566, 568, 570 Series Waterproof Connectors

Crimp Tools, Withdrawal Tool, Automated Crimping Tool

AUTOMATIC CONTACT CRIMP MACHINE

- Part Number 516-280-700 for base machine
- Applicators available to crimp all 566, 568 and 570 series contacts
- All required guards for operator safety
- Easy access for all setting changes
- Foot switch to initiate crimp cycle
- Mounts to any bench surface
- Quick change applicators allow for fast conversions from one contact type to another
- Requires 110V 50 / 60 Hz electrical supply



CONTACT HAND CRIMP TOOL

- Manual hand crimp tool
- Uses contacts on carrier strip, crimps them and cuts the contacts from the carrier
- For 566 series, use crimper number 566-280-200
- For 568 and 570 series, use either 570-280-200 for smaller diameter wire and part

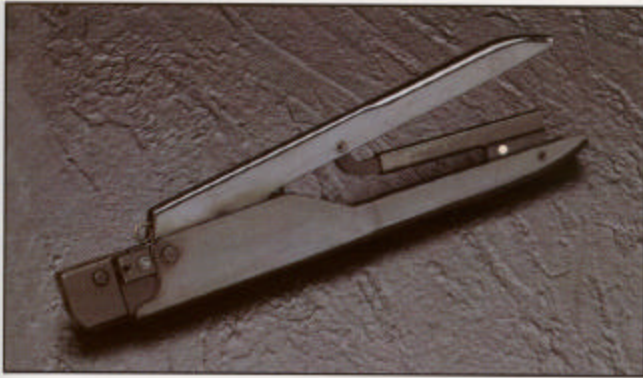

RETAINER INSERTION TOOL

- Tool to insert retainer into connector housing to ensure water tight seal
- Required for all 566 series connectors
- Part number 566-280-250



CONTACT EJECTION TOOL

- Tool to remove previously inserted contact from connector housing
- For use with 566 series, use tool part number 566-280-300
- For use with 568 and 570 series, use tool part number 570-280-300

556 SERIES EDACON CONNECTOR

Plug and Receptacle

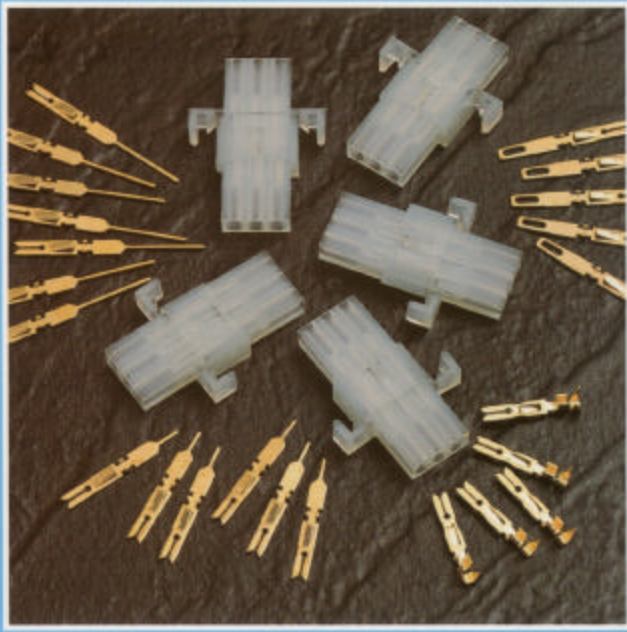

FEATURES

- UL Recognized
- .156 (3.96) Contact Spacing
- Plug and Receptacle in 3, 4, or 6 Contact Sizes
- Edacon Hermaphroditic Contact Mating Design
- Contact Termination Options include Crimp, P.C. Tail, Wire Hole, Wire Wrap and Taper Tail
- Tools Available for Contact Installation, Removal and Crimping
- These connectors are not waterproof.

SPECIFICATIONS

- Insulator Material: White Nylon
- Contact Material: Phosphor Bronze Alloy CA-510
- Contact Plating: Gold over Nickel for Entire Contact
- Current Rating: 8.5 Amperes
- Contact Resistance: 10 Milliohms Maximum
- Dielectric Withstanding Voltage: 2000 V AC rms at Sea Level
- Insulation Resistance: 5000 Megohms Minimum
- Operating Temperature: -65 to +125 Degrees C
- Insertion and Withdrawal Force: 2 to 16 oz (0.56 to 4.45 N) per Contact Position

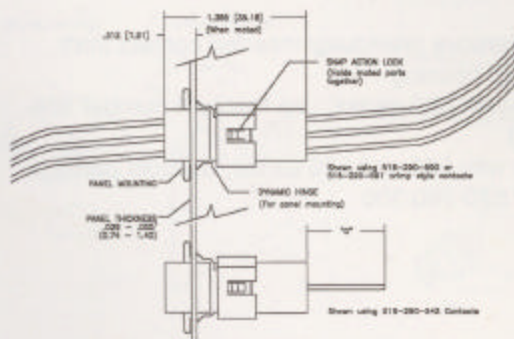

556 SERIES ORDERING CODE

Example Part Number **556 - 003 - 500 - 102**

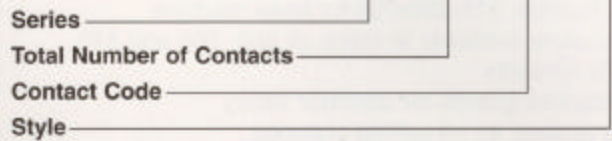

Series	556
Total Number of Contacts	003, 004 or 006

Contact Code ^{1,2}	Description & Tail Size	Tail Length "G"
000	No Contacts Assembled	-- --
500	Wire Hole .110 x .024 (2.79 x 0.61)	.245 (6.22)
501	Taper Tail	.245 (6.22)
520	P.C. Tail .025 x .024 (0.64 x 0.61)	.215 (5.46)
540	Wire Wrap .050 x .024 (1.27 x 0.61)	.600 (15.24)
541	Wire Wrap .026 x .024 (0.66 x 0.61)	.620 (15.75)
542	Wire Wrap .050 x .024 (1.27 x 0.61)	.790 (20.07)

Style and Material ³	Style
101	Plug
201	Receptacle with Panel Retention

Ordering Code Notes

- 1) Crimp contacts are available for the 556 series connectors. Contacts may be ordered separately for pre-wired or select position assembly.

Part Number	Description	
516-290-500	Wire Hole	
516-290-501	Taper Tail	
516-290-520	P.C. Tail	
516-290-540	Wire Wrap	
516-290-541	Wire Wrap	
516-290-542	Wire Wrap	
516-290-590	Crimp - Loose	
516-290-591	Crimp - 1800	

- 2) For contact installation, removal and crimping tools, refer to page 112.
- 3) Insulator design prevents improper mating of individual plug and receptacle.

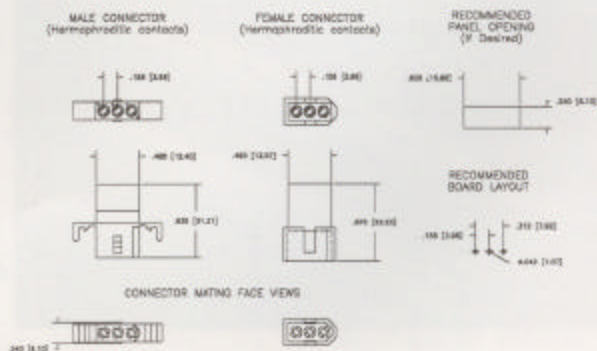

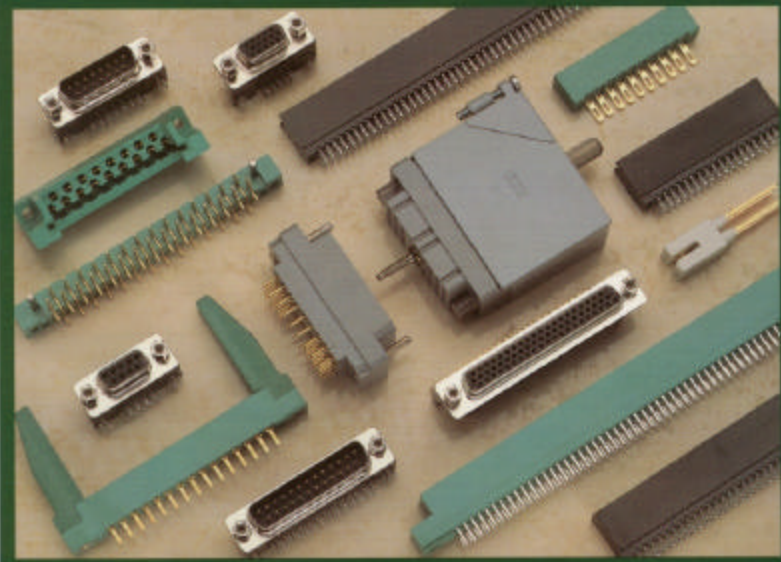

PRINTED IN CANADA 10M98A



an EDACOM company

**40 TIFFIELD ROAD
SCARBOROUGH, ONTARIO, CANADA M1V 5B6**

Telephone: (416)754-3322 Facsimile: (416)754-3299
E-mail: edac@edac.net Web Page: <http://www.edac.net>