

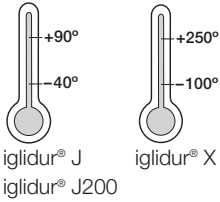

DryLin® R | Linear Plain Bearings, Fast and Quiet

DryLin® R linear plain bearings, made from solid polymers, are dimensionally equivalent to standard ball bearings. They are made entirely of wear resistant iglidur® materials and offer technical advantages as well as a clear price advantage.



iglidur® J
iglidur® J200
iglidur® X

Technical Data

Liners: Maintenance-free

Materials:

- iglidur® J
- iglidur® J200
- iglidur® X

Max. speed: up to 15 m/s

Shaft materials:

- Anodized aluminum
- Case-hardened steel
- Stainless steel
- Cold-rolled steel
- Hard chrome-plated
- carbon fibre



mm

DryLin® R

Phone +44 (0) 1604 - 67 72 40
Fax +44 (0) 1604 - 67 72 45



DryLin® R can be used in extreme dirt conditions

Advantages of DryLin® R

- Self-lubricating
- Maintenance-free
- Can be used in extreme dirt conditions
- Can be used underwater or in washdown conditions
- Replaceable liner
- Dimensionally interchangeable with standard recirculating ball bearings
- Vibration dampening
- No seals or wipers needed
- Compensation for shaft misalignment (O3 series)

iglus® UK Ltd



DryLin® R can be used in high temperature environments

1 Self aligning adapter aluminium anodized

2 Stainless steel adapter

3 Standard flanged housing aluminium anodized



4 Standard iglidur® J liner

5 High temperature iglidur® X liner



DryLin® R can be used for applications with aggressive chemicals

Internet www.igus.co.uk
E-mail sales_uk@igus.co.uk

DryLin® R | Material Table



General Properties	Unit	iglidur® J	iglidur® X	iglidur® J200	Testing Method
Density	g/cm ³	1,49	1,44	1,72	
Colour		Yellow	Black	Dark grey	
Max. moisture absorption at 23 °C/50% r.F.	% weight	0,3	0,1	0,2	DIN 53495
Max. moisture absorption	% weight	1,3	0,5	0,7	
Coefficient of sliding friction, dynamic against steel	μ	0,06 - 0,18	0,09 - 0,27	0,11 - 0,17	
p x value, max. (dry)	MPa x m/s	0,34	1,32	0,3	

Mechanical Properties

Modulus of elasticity	MPa	2.400	8.100	2.800	DIN 53457
Tensile strength at 20 °C	MPa	73	170	58	DIN 53452
Compressive strength	MPa	60	100	n.d.	
Permissible static surface pressure (20 °C)	MPa	35	150	23	
Shore D hardness		74	85	70	DIN 53505

Physical and Thermal Properties

Max. long term application temperature	°C	90	250	90	
Max. short term application temperature	°C	120	315	120	
Min. application temperature	°C	-50	-100	-50	
Thermal conductivity	W/m x K	0,25	0,6	0,24	ASTM C 177
Coefficient of thermal expansion (at 23 °C)	K ⁻¹ x 10 ⁻⁵	10	5	8	DIN 53752

Electrical Properties

Specific volume resistance	Ωcm	> 10 ¹³	< 10 ⁵	> 10 ⁸	DIN IEC 93
Surface resistance	Ω	> 10 ¹²	< 10 ³	> 10 ⁸	DIN 53482

Table 64.1: Material Data

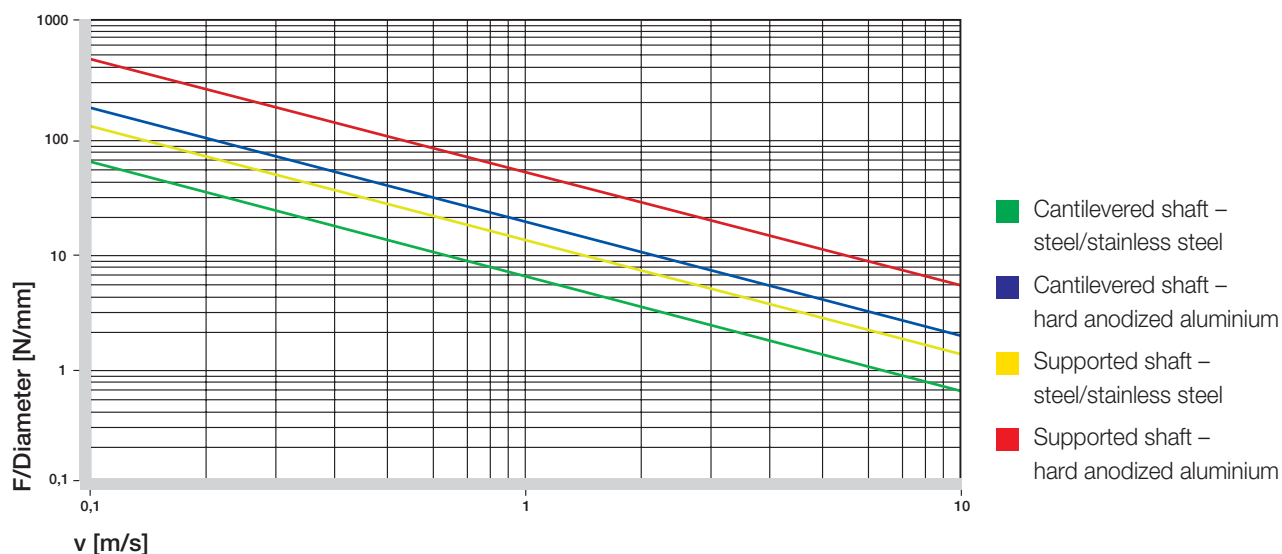

Graph 64.1: DryLin® R – Comparison of the permissible dynamic loads at equivalent diameters

DryLin® R

mm

Phone +44 (0) 1604 - 67 72 40
Fax +44 (0) 1604 - 67 72 45

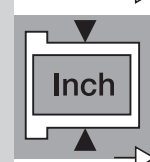



DryLin® R – Order example



TJUM-03-20



Inner diameter, nominal

Housing type

- 01 = Standard
- 02 = Thin-walled
- 03 = Self-aligning
- 05 = Pillow block, short
- 06 = Pillow block, long

Measuring system

- M = Metric
- I = Inches
- J = Japan-Standard

Bearing design

- U = Liner with U configuration
- L = Series L1
- Z = Pressfit sleeve bearing

Bearing material

- J = iglidur® J liner (standard)
- L = iglidur® L100 pressfit bearing
- X = iglidur® X for high temperatures, round bearing
- W = iglidur® W300 round bearing
- J200 = iglidur® J200

Housing

- R = Closed
- O = Open
- T = Split
- F = Flange



DryLin® R Linear Plain Bearings

The DryLin® standard round bearings consist of a replaceable iglidur® J liner, that is manufactured to be a mechanical fit into an anodized aluminium adapter. The liner snaps into a groove which provides total axial security.

DryLin® R linear plain bearings, made from solid polymer, are dimensionally equivalent to standard ball bearings. They are made entirely out of wear resistant iglidur® J materials and can offer technical advantages in addition to the clear price advantage. Thus, applications in which machine parts are primarily stainless steel, i.e. food and filling equipment, are well suited for the use of solid plastic bearings. An additional weight-saving is also easily obtained.

Both types are designed for fitting in housings with the recommended tolerance H7. The bearings are secured by circlips in the same way as with ball bearings.

The narrow design of the 02 design series, is pressfit or bonded into the housing. Standard commercial adhesives can be used for this purpose.

Dirt, dust, fibres

An important feature of all the linear plain bearings is their tolerance of dirt and abrasive particles. For most conventional bearing systems, the use of wiper or seals is recommended to prevent dirt accumulation.

No other system has the design benefits for use in dust, lint, and coarse dirt as DryLin®. The patented design of the bearing surface using individual slide pads connected by thin film sections, provides performance benefits for dirty environments. Dirt, even if it becomes wet on the shaft, is wiped away by the individual glide pads and is moved into the open areas. The running sections of the DryLin® bearings then slide on the shaft that has been cleared of all contaminants.

Split linear bearings

Applications that are on the edge of technical feasibility or in extremely harsh environments often require frequent replacement of the linear bearings. In many cases, DryLin® can give a multiple increase in the service life. However, in extreme applications, replacement of the bearings is necessary, even with DryLin®. DryLin® linear bearings can provide considerable cost reductions in such cases as only the polymer bearing liner has to be replaced. This often means a reduction of more than 90% in replacement part costs. The iglidur® J liner can be easily replaced, while a ball-bearing cage cannot.

The range of split adapters offers even greater cost savings. Shafts no longer need to be removed from the housing. The two shells of the adapter can be opened very easily. The high performance polymer bearing inside is split and can easily be pulled off the shaft. Clip a new bearing liner over the shaft, put the two adapter halves together, fit – done! With this product line of split DryLin® bearings, installation times can be reduced to a minimum.

mm

DryLin® R

Phone +44 (0) 1604 - 67 72 40
Fax +44 (0) 1604 - 67 72 45

igus® UK Ltd

Internet www.igus.co.uk
E-mail sales_uk@igus.co.uk

DryLin® R | Floating Bearings/Self-Alignment



Self-Aligning Bearings

DryLin® R linear plain bearings in the 03 design series offer great advantages in applications with parallel shafts. By their geometry, they are able to compensate for alignment and parallelism errors and should be used on the shaft located furthest from the drive mechanism.

The design provides a spherical area on the outside diameter of the aluminium adapter for self-alignment. Reductions in load capacity are prevented, since the shaft always lies on the total projected surface.

Due to the even load distribution over the entire bearing, edge loads are eliminated with the self-aligning DryLin® linear bearings. Even in unfavourable conditions, the load is supported by the entire projected surface.

In order to compensate for parallelism errors between two shafts, the outer diameter is designed to be smaller than the housing bore diameter by 0.2 - 0.3 mm (depending on the size). With the use of mounted O-rings, these bearings have an elastic bearing seat. The clearance between the bearing and housing allows for the maximum compensation of possible shaft misalignment.

The DryLin® R self-aligning bearings are supplied hard anodized. These surfaces guarantee the highest wear resistance if the aluminium bearing moves in the housing during compensation adjustments.

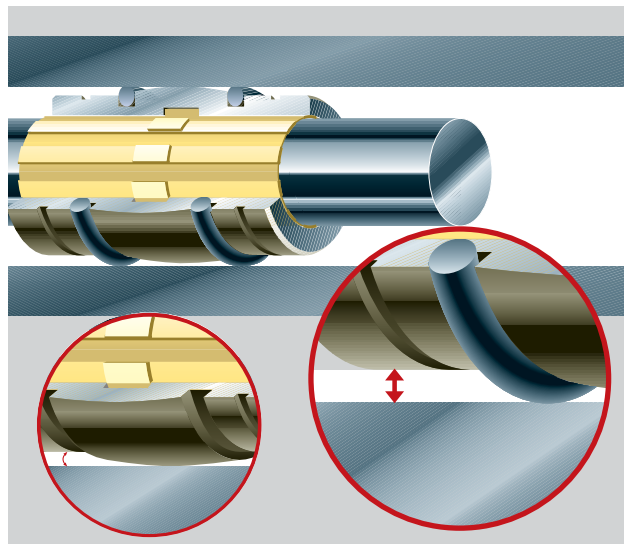

Picture 64.1: The spherical DryLin® housings compensate to parallelism and angular errors, and are hard anodised to protect against wear.

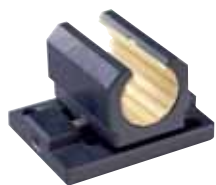

OJUM-06 LL



RJUM-06 LL

Eccentric Forces

To ensure successful use of maintenance-free DryLin® linear bearings, it is necessary to follow certain recommendations: If the distance between the driving force point and the fixed bearings is more than twice the bearing spacing (2:1 rule), a static friction value of 0.25 can theoretically result in jamming on the guides. This principle applies regardless of the value of the load or drive force.

The friction product is always related to the fixed bearings. The greater the distance between the drive and guide bearings, the higher the degree of wear and required drive force. Failure to observe the 2:1 rule during a use of linear slide bearings can result in uneven motion or even system blockage. Such situations can often be remedied with relatively simple modifications. If you have any questions on design and/or assembly, please contact our application engineers.

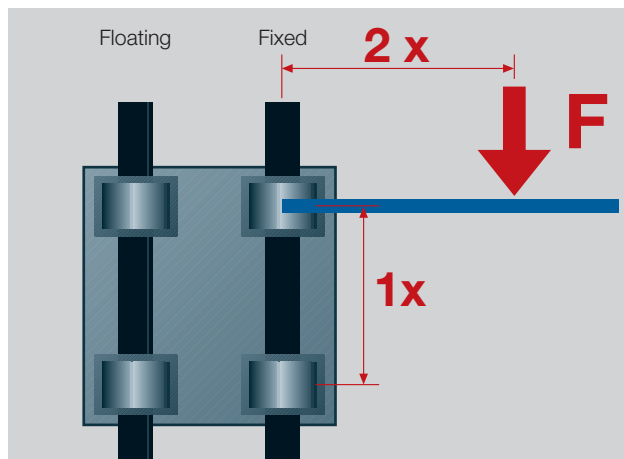

The 2:1 Rule

Series RJUM-03 / OJUM-03	+/- 0,5°
Series RJUM-06 LL / OJUM-06 LL	+/- 3,5°

Table 64.2: Compensation of angular errors

Series RJUM-03 / OJUM-03	+/- 0,1 mm
Series RJUM-06 LL / OJUM-06 LL	+/- 3 mm

Table 64.3: Compensation of parallelism errors

Product Range:



RJUM-03:
▶ P. 64.15

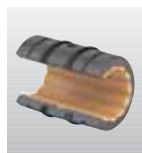

OJUM-03:
▶ P. 64.26

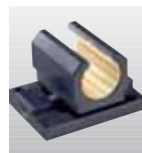

OJUM-06 LL:
▶ P. 64.28

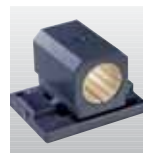

RJUM-06 LL:
▶ P. 64.24

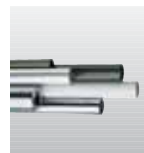

Shafts:
▶ P. 64.44

DryLin® R

mm

Phone +44 (0) 1604 - 67 7240

Fax +44 (0) 1604 - 67 7245

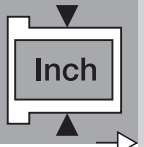



DryLin® R | Liner JUM-01 | mm

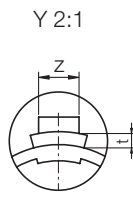
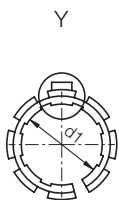
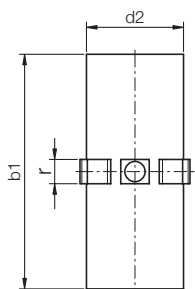

Structure – part no.
J U M-01-10



mm

DryLin® R

Phone +44 (0) 1604 - 677240
Fax +44 (0) 1604 - 677245

iglus® UK Ltd

Internet www.igus.co.uk
E-mail sales_uk@igus.co.uk

Special properties

- Very low coefficient of friction while running dry
- Very low moisture absorption
- Very high wear resistance
- High chemical resistance
- Maintenance-free
- Suitable for rotating, oscillating and linear movements
- Vibration dampening

* According to iglus® testing method
▶ Page 64.67

Available from stock

Dimensions [mm] and Weight

Part No.	d1 [mm]	Tolerance* [mm]	d2 [mm]	b1 [mm]	r [mm]	t [mm]	z [mm]	Weight [g]
JUM-01-10	10	0,03-0,070	12	29	3,0	0,8	2,5	1,10
JUM-01-12	12	0,03-0,070	14	31	3,0	0,8	3,0	1,50
JUM-01-16	16	0,03-0,070	18	35	3,5	0,8	3,5	2,20
JUM-01-20	20	0,03-0,070	23	44	5,0	0,8	3,5	4,90
JUM-01-25	25	0,03-0,070	28	57	5,0	0,8	4,0	8,23
JUM-01-30	30	0,04-0,085	34	67	5,0	0,8	4,0	14,95
JUM-01-40	40	0,04-0,085	44	79	6,0	1,3	5,0	23,16
JUM-01-50	50	0,05-0,100	55	99	7,0	1,3	6,0	45,35
JUM-01-60	60	0,05-0,100	65	124	8,0	2,5	6,5	70,00

Installation Drawings

Housing Bore, Dimensions [mm]

Part No.	Shaft Size Ø	di [mm]	B [mm]	r [mm]	t [mm]	f [mm]	z [mm]
		H7	h10	+0,05	+0,1	+0,5	+0,2
JUM-01-10	10	12	29	3,0	1,0	1,0	2,6
JUM-01-12	12	14	32	3,0	1,0	1,5	3,1
JUM-01-16	16	18	36	3,5	1,0	1,7	3,6
JUM-01-20	20	23	45	5,0	1,0	2,0	3,6
JUM-01-25	25	28	58	5,0	1,0	2,0	4,1
JUM-01-30	30	34	68	5,0	1,0	2,0	4,1
JUM-01-40	40	44	80	6,0	1,5	2,5	5,1
JUM-01-50	50	55	100	7,0	1,5	2,5	6,1
JUM-01-60	60	65	124	8,0	2,5	3,0	6,5

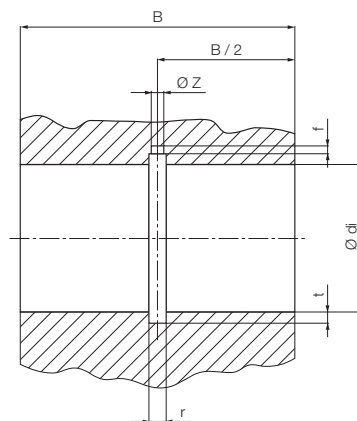

Liners of the series JUM-01 are used in:



RJUM-01:
▶ P. 64.11



RJUM-03:
▶ P. 64.15



TJUM-01:
▶ P. 64.14



TJUM-03:
▶ P. 64.16

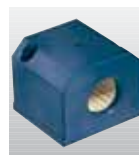

RJUM-06:
▶ P. 64.23

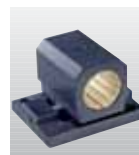

RJUM-06 LL:
▶ P. 64.24



FJUM-01:
▶ P. 64.30



FJUM-02:
▶ P. 64.31