

Deep groove ball bearings, single row

Principal dimensions			Basic load ratings		Fatigue load limit P_u	Speed ratings		Mass	Designation
d	D	B	dynamic	static		Reference speed	Limiting speed		
mm			kN		kN	r/min		kg	-
55	90	18	29,6	21,2	0,9	-	4500	0,39	6011-2RS1 *

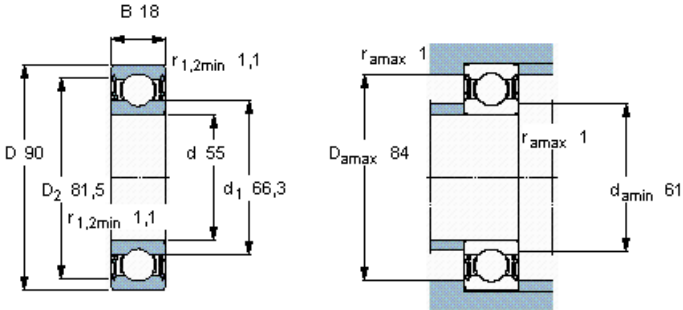

Calculation factors

k_r 0,025
 f_0 15