



Pneumatic Cylinders

Series P1A

According to ISO 6432

Catalogue 9127006842GB-ul



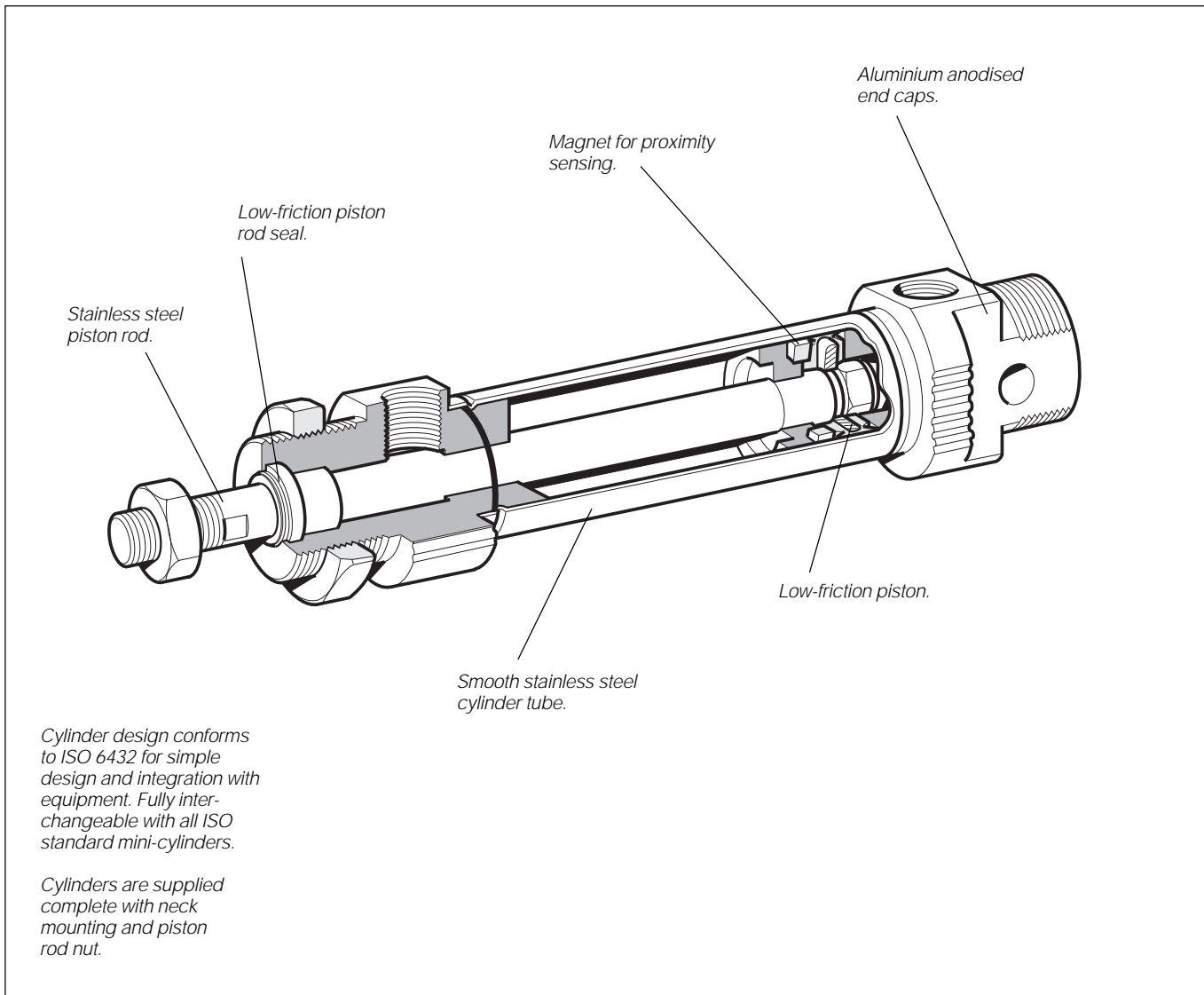

Double and single-acting versions

The Parker Pneumatic P1A range of cylinders is intended for use in a wide range of applications. The cylinders are particularly suitable for lighter duties in the packaging, food and textile industries.

Hygienic design, the use of corrosion-resistant materials and initial lubrication with our food-grade grease makes the cylinders suitable for food industry applications.

Careful design and high quality manufacture throughout ensure long service life and optimum economy.

Mounting dimensions fully in accordance with ISO 6432 and CETOP RP52P greatly simplifies installation and world-wide interchangeability.

The cylinders are available in bores of 10, 12, 16, 20 and 25 mm, with stroke lengths from 10 mm to 320 mm.

Single-acting cylinders with spring return in the retract direction are available in stroke lengths up to 80 mm.

Single-acting cylinders with spring return in the advance direction are available in 16 mm, 20 mm and 25 mm bore sizes and with stroke lengths up to 80 mm.

Double-acting cushioned cylinders

Adjustable pneumatic cushioning permits greater loads and higher operating speeds, making the cylinders suitable for more demanding duties.

These cylinders are available in bores of 16, 20 and 25 mm, with stroke lengths from 20 mm to 500 mm.

Options

In addition to a wide range of standard cylinders, Mini ISO cylinders are available in several standard variants, such as non-standard stroke length, extended piston rods, double piston rods, high and low-temperature versions etc. In addition, a complete range of sensors and fittings is available.

Effective cushioning

The Mini ISO range is available with fixed end cushioning or with adjustable pneumatic cushioning, controlled by simple bleed screws for fine adjustment. The adjustable cushioned cylinders can be operated with higher mass loads and at higher speeds than those with fixed end cushioning, reducing overall cycle times.

Smooth external design

There are no recesses or pockets in the end covers that could trap dirt or liquid, making cleaning simple and effective.

Corrosion-resistant

Even the basic versions of the cylinders have good corrosion resistance through appropriate choice of materials and surface treatment, allowing them to be used directly in demanding environments.

Stainless steel versions

The Mini ISO range is also available in an all-stainless version with piston rod, barrel and end covers of stainless steel for use in particularly severe environments. See separate brochure 9127005082GB-ul.

Proximity sensing

A complete range of sensors for proximity sensing is available as accessories: both reed switch and Hall effect sensors are available. They are supplied with either flying lead or cable plug connector.

Variants

In addition to the basic versions, a number of standard variants of Parker Pneumatics cylinders are available to meet exacting demands on function and environmental adaptation:

Non-standard stroke lengths

Extended piston rods

Through piston rods

Through, hollow piston rods

Single acting cylinder with spring return (in the retract direction).

Single acting cylinder with spring return in the advance direction (piston rod in extended position)

External guide, for controlled guidance of the piston rod

High-temperature cylinder versions for use in ambient temperatures ranging from -10 °C to +150 °C for bores 20 and 25 mm and -10 °C to +120 °C for bores 10, 12 and 16 mm

Low-temperature cylinder versions for ambient temperatures ranging from -40 °C to +60 °C

Cylinders for completely dry operation, without pre-lubrication

Teflon and copper free cylinders

Cylinders with outer sealings in fluorocarbon

Stainless steel cylinders, see brochure 9127005082GB-ul

Double-acting, cushioned stroke

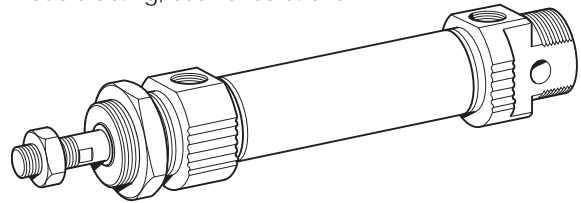

Double-acting, adjustable cushioning

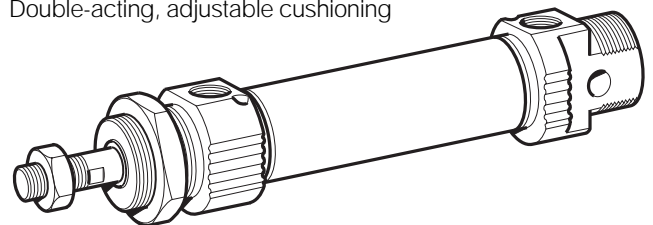

Double-acting, through piston rod

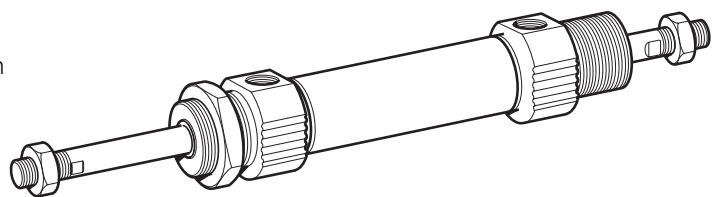

Single-acting, spring return

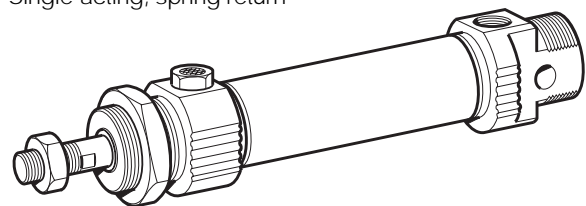

Single-acting, spring-extended

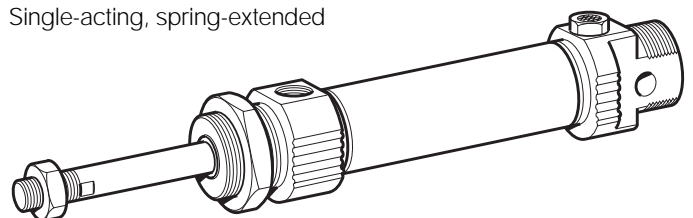

Double-acting, external guide device

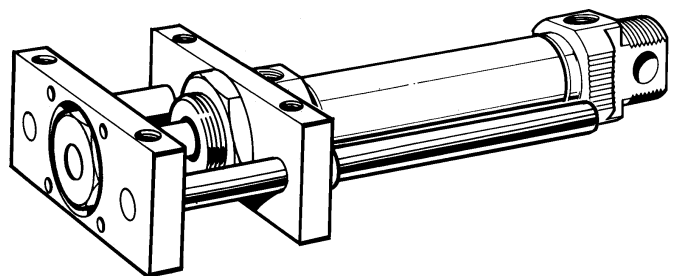

Contents

Contents	Page
General	2
P1A - Main data	4
Ordering data	7
External guide device	10
Mountings and accessories	11
Sensors	14

Main data

Cylinder designation	Cylinder bore		Piston rod		thread	Total mass		Air consumption	Conn. thread
	mm	cm ²	mm	cm ²		at 0 mm stroke	addition per 10 mm stroke		
Double acting, cushioned stroke									
P1A-S 010 D	10	0,78	4	0,13	M4	0,04	0,003	0,0100 ¹⁾	M5
P1A-S 012 D	12	1,13	6	0,28	M6	0,07	0,004	0,0139 ¹⁾	M5
P1A-S 016 D	16	2,01	6	0,28	M6	0,09	0,005	0,0262 ¹⁾	M5
P1A-S 020 D	20	3,14	8	0,50	M8	0,18	0,007	0,0405 ¹⁾	G1/8
P1A-S 025 D	25	4,91	10	0,78	M10x1,25	0,25	0,011	0,0633 ¹⁾	G1/8
Double acting, adjustable cushioning									
P1A-S 016 M	16	2,01	6	0,28	M6	0,09	0,005	0,0262 ¹⁾	M5
P1A-S 020 M	20	3,14	8	0,50	M8	0,18	0,007	0,0405 ¹⁾	G1/8
P1A-S 025 M	25	4,91	10	0,78	M10x1,25	0,25	0,011	0,0633 ¹⁾	G1/8
Single acting									
P1A-S 010 SS	10	0,78	4	0,13	M4	0,04	0,003	0,0055 ¹⁾	M5
P1A-S 012 SS	12	1,13	6	0,28	M6	0,08	0,004	0,0079 ¹⁾	M5
P1A-S 016 SS(TS)	16	2,01	6	0,28	M6	0,10	0,005	0,0141 ¹⁾	M5
P1A-S 020 SS(TS)	20	3,14	8	0,50	M8	0,18	0,007	0,0220 ¹⁾	G1/8
P1A-S 025 SS(TS)	25	4,91	10	0,78	M10x1,25	0,26	0,011	0,0344 ¹⁾	G1/8

1) Free air consumption per 10 mm stroke length for a double stroke at 6 bar

Cylinder forces

Indicated cylinder forces are theoretical and should be reduced according to the working conditions.

Order code	Cylinder-bore	Theoretical piston force at 600 kPa (6 bar)		Order code	Theoretical piston force at 600 kPa (6 bar)		Spring retraction		
		plus stroke	minus stroke		Nmax	Nmin	Nmax	Nmin	
	mm	N	N						
Double acting				Single acting					
P1A-S 010 D	10	47	39	P1A-S 010 SS - 10	38	36	11	9	
P1A-S 012 D	12	67	50	P1A-S 010 SS - 15	38	36	11	9	
P1A-S 016 D	16	120	103	P1A-S 010 SS - 25	39	36	11	8	
P1A-S 020 D	20	188	158	P1A-S 010 SS - 40	38	34	13	9	
P1A-S 025 D	25	294	247	P1A-S 010 SS - 50	39	34	13	8	
				P1A-S 010 SS - 80	39	34	13	8	
P1A-S 016 M	16	120	103	P1A-S 012 SS - 10	53	51	16	14	
P1A-S 020 M	20	188	158	P1A-S 012 SS - 15	53	51	16	14	
P1A-S 025 M	25	294	247	P1A-S 012 SS - 25	55	51	16	12	
				P1A-S 012 SS - 40	52	48	19	15	
				P1A-S 012 SS - 50	53	48	19	14	
				P1A-S 012 SS - 80	55	48	19	12	
				P1A-S 016 SS(TS) - 10	102 (85)	99 (84)	21 (19)	18 (18)	
				P1A-S 016 SS(TS) - 15	103 (86)	99 (84)	21 (19)	17 (17)	
				P1A-S 016 SS(TS) - 25	105 (88)	99 (84)	21 (19)	15 (15)	
				P1A-S 016 SS(TS) - 40	106 (90)	95 (84)	25 (19)	14 (13)	
				P1A-S 016 SS(TS) - 50	108 (91)	95 (84)	25 (19)	12 (12)	
				P1A-S 016 SS - 80	107	95	25	13	
				P1A-S 020 SS(TS) - 10	163 (132)	161 (130)	27 (28)	25 (26)	
				P1A-S 020 SS(TS) - 15	164 (133)	161 (130)	27 (28)	24 (25)	
				P1A-S 020 SS(TS) - 25	167 (135)	161 (130)	27 (28)	21 (23)	
				P1A-S 020 SS(TS) - 40	166 (138)	159 (130)	29 (28)	22 (20)	
				P1A-S 020 SS(TS) - 50	168 (140)	159 (130)	29 (28)	20 (18)	
				P1A-S 020 SS(TS) - 80	170 (139)	161 (108)	27 (50)	18 (19)	
				P1A-S 025 SS(TS) - 10	256 (205)	253 (203)	41 (44)	38 (42)	
				P1A-S 025 SS(TS) - 15	258 (207)	253 (203)	41 (44)	36 (40)	
				P1A-S 025 SS(TS) - 25	262 (210)	253 (203)	41 (44)	32 (37)	
				P1A-S 025 SS(TS) - 40	261 (214)	250 (203)	44 (44)	33 (33)	
				P1A-S 025 SS(TS) - 50	264 (217)	250 (203)	44 (44)	30 (30)	
				P1A-S 025 SS(TS) - 80	264 (223)	251 (206)	43 (41)	30 (24)	

**Important**

Before attempting any external or internal work on the cylinder or any connected components, make sure the cylinder is vented and disconnect the air supply in order to ensure isolation of the air supply.

Cushioning diagram

Use the diagram below to determine the necessary size of cylinder to provide the requisite cushioning performance. The maximum cushioning performance, as indicated in the diagram, is based on the following assumptions:

- Low load, i.e. low pressure drop across the piston
- Steady-state piston speed
- Correctly adjusted cushioning screw

The load is the sum of the internal and external friction, together with any gravity forces. At high relative loading it is recommended that, for a given speed, the load should be reduced by a factor of 2.5, or that, for a given mass, the speed should be reduced by a factor of 1.5. These factors apply in relation to the maximum performance as shown in the diagram.

Fixed end-cushioning

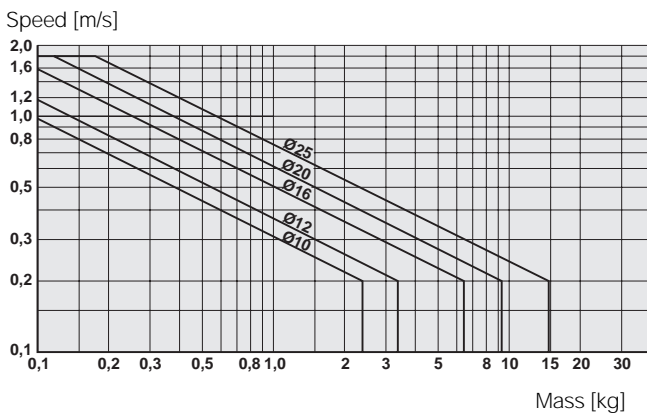

Adjustable pneumatic end-cushioning

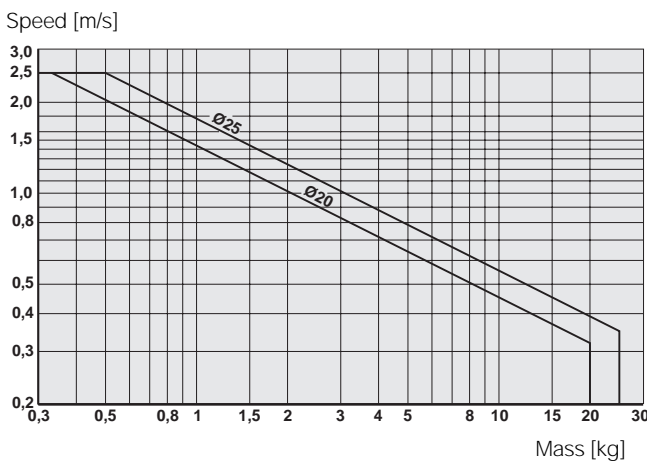

Material specification

Piston rod	Stainless steel, DIN X 10 CrNiS 18 9
Piston rod seal	Fluorocarbon rubber FPM
Piston rod bearing	Multilayer PTFE/steel
End covers	Anodized aluminium
O-ring, internal	Nitrile rubber, NBR
Cylinder barrel	Stainless steel, DIN X 5 CrNi 18 10
Piston, complete	Nitrile rubber, NBR/steel
Magnet holder	Thermoplastic elastomer
Magnet	Plastic-coated magnetic material
Return spring	Surface-treated steel
Cushioning screw	Stainless steel, DIN X 10 CrNiS 18 9

Variants Mini ISO:

Low-temperature version, type L:

Piston rod seal	Nitrile rubber, NBR
Piston complete	Nitrile rubber, NBR/steel

High-temperature version, type F:

Piston rod seal	Fluorocarbon rubber, FPM
Piston complete, Ø10-Ø16	HNBR/steel
Piston complete, Ø20-Ø25	FPM/steel

Cylinders for dry operation, type D:

Sealings	Nitrile rubber, NBR/HDPE plastic
Scraper ring	Fluorocarbon rubber, FPM/HDPE plastic

Teflon and copper free cylinders , type N:

Piston rod bearing	PA plastic
--------------------	------------

Cylinders with outer sealings in fluorocarbon, type V:

Piston rod seal/	
Scraper ring	Fluorocarbon rubber, FPM

Note:

Spare part = new cylinder











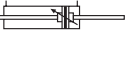
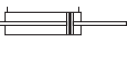
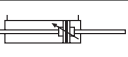

Note
Air quality is essential for maximum cylinder service life (see ISO 8573).

Note
All technical data in this catalogue are typical data only.

Order key

P1A - S 016 M S - 0025

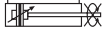
Cylinder bore mm	Cylinder type / function	Stroke length, mm
010	M  Double-acting, adjustable cushioning. Ø16-25 mm. Not for sealing material type D, F and L	E.g. 0025 = 25 mm For standard stroke length and max length see tabel below.
012	D  Double-acting, non-adjustable cushioning, Ø10 - Ø25	Sealing material
016	F  Double-acting, adjustable cushioning, thru-rod, Ø16-25 mm. Not for sealing material type D, F and L	
020	K  Double-acting, non-adjustable cushioning, thru-rod, Ø10 - Ø25	S Standard, -20 °C to +80 °C. Magnetic piston
025	H  Double-acting, adjustable cushioning, thru-rod (hollow), Ø20-25 mm, max. stroke 125 mm. Not for sealing material type D, F and L	D Dry operation, completely non-lubricated -20 °C to +80 °C. Magnetic piston
	P  Double-acting, non-adjustable cushioning, thru-rod (hollow), Ø20-25 mm, max. stroke 125 mm	F  High temperature, Ø10, 12 and 16 mm -10 °C to +120 °C. Ø20 and 25 mm -10 °C to +150 °C. Not magnetic piston
	S  Single-acting, non-adjustable cushioning, spring return for retract stroke, Ø10-25 mm	L  Low temperature, -40 °C to +60 °C. Not magnetic piston
	T  Single-acting, non-adjustable cushioning, spring return for advance stroke, Ø16-25 mm	N No Teflon™ or copper. Standard seals, -20 °C to +60 °C. Magnetic piston
		V External seals of fluorinated rubber. -20 °C to +80 °C. Magnetic piston

Cylinder version
S Standard cylinder acc. to Cylindertype/function
G Cylinder with external guide device Only double-acting Ø20 - Ø25 mm.
type M 
and D 

Stroke length

Cylinder designation	Cylinder bore	● Standard stroke length in mm								■ Non standard stroke length							
		10	15	20	25*	30	40	50*	80*	100*	125*	160*	200*	250*	320*	400*	500*
Double acting with fixed end-cushioning:																	
P1A-S 010 D	10	●	●	●	●	●	●	●	●	●	●	●	●	●	●	●	●
P1A-S 012 D	12	●	●	●	●	●	●	●	●	●	●	●	●	●	●	●	●
P1A-S 016 D	16	●	●	●	●	●	●	●	●	●	●	●	●	●	●	●	●
P1A-S 020 D	20	●	●	●	●	●	●	●	●	●	●	●	●	●	●	●	●
P1A-S 025 D	25	●	●	●	●	●	●	●	●	●	●	●	●	●	●	●	●
Double acting with adjustable end-cushioning:																	
P1A-S 016 M	16	●	●	●	●	●	●	●	●	●	●	●	●	●	●	●	●
P1A-S 020 M	20	●	●	●	●	●	●	●	●	●	●	●	●	●	●	●	●
P1A-S 025 M	25	●	●	●	●	●	●	●	●	●	●	●	●	●	●	●	●
Single acting:																	
P1A-S 010 SS	10	●	●	●	●	●	●	●	●	●	●	●	●	●	●	●	●
P1A-S 012 SS	12	●	●	●	●	●	●	●	●	●	●	●	●	●	●	●	●
P1A-S 016 SS(TS)	16	●	●	●	●	●	●	●	●	●	●	●	●	●	●	●	●
P1A-S 020 SS(TS)	20	●	●	●	●	●	●	●	●	●	●	●	●	●	●	●	●
P1A-S 025 SS(TS)	25	●	●	●	●	●	●	●	●	●	●	●	●	●	●	●	●

*Standard stroke lengths in mm according to ISO 4393

** Not for the TS version

Double acting cylinders

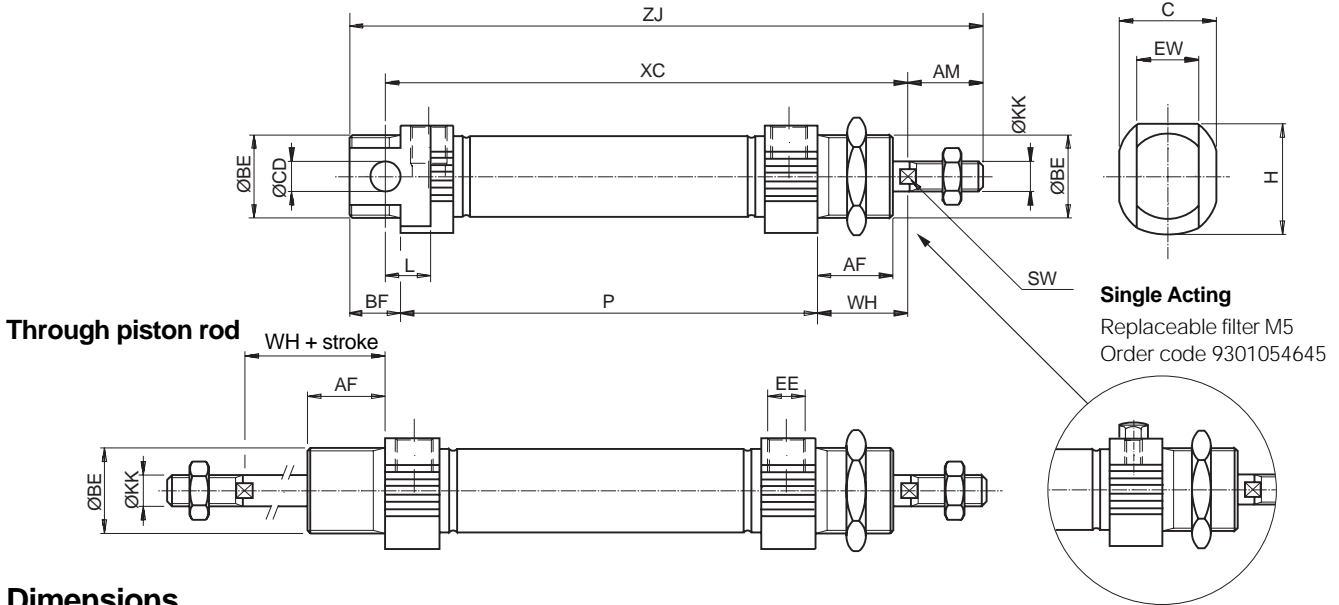

Through piston rod

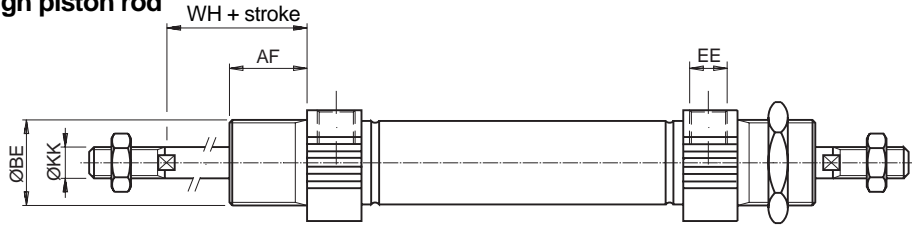

Dimensions

Cylinder bore mm	AM 0/-2 mm	BE	AF mm	BF mm	C mm	CDH9 mm	EE	EW mm	H mm	KK	L mm	SW mm	WH±1,2 mm
10	12	M12x1,25	12	10	14	4	M5	8	16,7	M4	6	-	16
12	16	M16x1,5	18	13	18	6	M5	12	19,1	M6	9	5	22
16 ¹⁾	16	M16x1,5	18	13	18	6	M5	12	19,1	M6	9	5	22
16 ²⁾	16	M16x1,5	18	13	25	6	M5	12	24	M6	9	5	22
20	20	M22x1,5	20	14	24	8	G1/8	16	27	M8	12	7	24
25	22	M22x1,5	22	14	27,5	8	G1/8	16	29	M10x1,25	12	9	28

- 1) P1A-S016DS/SS/TS
- 2) P1A-S016MS

Double acting cylinders

Cylinder bore mm	XC mm	ZJ mm	P mm
10	64 + stroke	84 + stroke	46 + stroke
12	75 + stroke	99 + stroke	48 + stroke
16	82 + stroke	104 + stroke	53 + stroke
20	95 + stroke	125 + stroke	67 + stroke
25	104 + stroke	132 + stroke	68 + stroke

Single-acting, spring return, type SS

Stroke/ Cylinder bore mm	10 mm	15 mm	25 mm	40 mm	50 mm	80 mm	10 mm	15 mm	25 mm	40 mm	50 mm	80 mm	10 mm	15 mm	25 mm	40 mm	50 mm	80 mm
	XC	XC	XC	XC	XC	XC	ZJ	ZJ	ZJ	ZJ	ZJ	ZJ	P	P	P	P	P	P
10	74	79	89	126	136	174	96	101	111	148	158	196	56	61	71	108	118	156
12	85	90	100	132	142	185	114	119	129	161	171	214	58	63	73	105	115	158
16	92	97	107	122	132	184	119	124	134	149	159	211	63	68	78	93	103	155
20	105	110	120	135	145	191	141	146	156	171	181	227	77	82	92	107	117	163
25	114	119	129	144	154	201	150	155	165	180	190	237	78	83	93	108	118	165

Single-acting, spring-extended, type TS

Stroke/ Cylinder bore mm	10 mm	15 mm	25 mm	40 mm	50 mm	80 mm	10 mm	15 mm	25 mm	40 mm	50 mm	80 mm	10 mm	15 mm	25 mm	40 mm	50 mm	80 mm
	XC ³⁾	XC ³⁾	XC ³⁾	XC ³⁾	XC ³⁾	XC ³⁾	ZJ ³⁾	ZJ ³⁾	ZJ ³⁾	ZJ ³⁾	ZJ ³⁾	ZJ ³⁾	P	P	P	P	P	P
16	107	112	122	137	147	-	134	139	149	164	174	-	78	83	93	108	118	-
20	120	125	135	150	160	195	156	161	171	186	196	231	92	97	107	122	132	167
25	129	134	144	159	169	205	165	170	180	195	205	241	93	98	108	123	133	169

3) With piston rod retracted, as shown in the dimension drawing

Length tolerances ± 1 mm
Stroke length tolerances +1,5/0 mm

Data

Working pressure
Working temperature

max. 10 bar
max. +80 °C
min. -20 °C

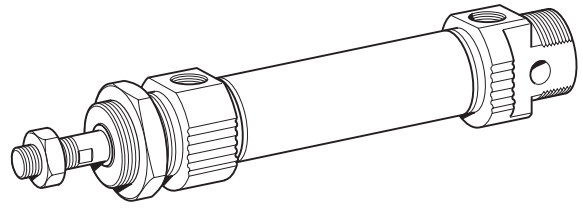

Double-acting

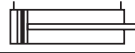

Cyl.bore mm	Stroke mm	Order code	
10	10	P1A-S010DS-0010	
	15	P1A-S010DS-0015	
	20	P1A-S010DS-0020	
	25	P1A-S010DS-0025	
	30	P1A-S010DS-0030	
	40	P1A-S010DS-0040	
	50	P1A-S010DS-0050	
	80	P1A-S010DS-0080	
	100	P1A-S010DS-0100	
	125	P1A-S010DS-0125	
	Conn. M5	10	P1A-S012DS-0010
		15	P1A-S012DS-0015
20		P1A-S012DS-0020	
25		P1A-S012DS-0025	
30		P1A-S012DS-0030	
40		P1A-S012DS-0040	
50		P1A-S012DS-0050	
80		P1A-S012DS-0080	
100		P1A-S012DS-0100	
125		P1A-S012DS-0125	
160		P1A-S012DS-0160	
200		P1A-S012DS-0200	
Conn. M5	10	P1A-S016DS-0010	
	15	P1A-S016DS-0015	
	20	P1A-S016DS-0020	
	25	P1A-S016DS-0025	
	30	P1A-S016DS-0030	
	40	P1A-S016DS-0040	
	50	P1A-S016DS-0050	
	80	P1A-S016DS-0080	
	100	P1A-S016DS-0100	
	125	P1A-S016DS-0125	
	160	P1A-S016DS-0160	
	200	P1A-S016DS-0200	

Double-acting

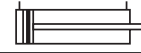

Cyl.bore mm	Stroke mm	Order code	
20	10	P1A-S020DS-0010	
	15	P1A-S020DS-0015	
	20	P1A-S020DS-0020	
	25	P1A-S020DS-0025	
	30	P1A-S020DS-0030	
	40	P1A-S020DS-0040	
	50	P1A-S020DS-0050	
	80	P1A-S020DS-0080	
	100	P1A-S020DS-0100	
	125	P1A-S020DS-0125	
	160	P1A-S020DS-0160	
	200	P1A-S020DS-0200	
Conn. G1/8	250	P1A-S020DS-0250	
	320	P1A-S020DS-0320	
	25	10	P1A-S025DS-0010
		15	P1A-S025DS-0015
		20	P1A-S025DS-0020
		25	P1A-S025DS-0025
		30	P1A-S025DS-0030
		40	P1A-S025DS-0040
		50	P1A-S025DS-0050
		80	P1A-S025DS-0080
		100	P1A-S025DS-0100
		125	P1A-S025DS-0125
160		P1A-S025DS-0160	
200		P1A-S025DS-0200	
Conn. G1/8	250	P1A-S025DS-0250	
	320	P1A-S025DS-0320	

Cylinders are supplied complete with neck mounting and piston rod nuts.
Cylinders with Through piston rods are supplied with two piston rod nuts and one neck mounting nut.

Data

Working pressure
Working temperature

max. 10 bar
max. +80 °C
min. -20 °C

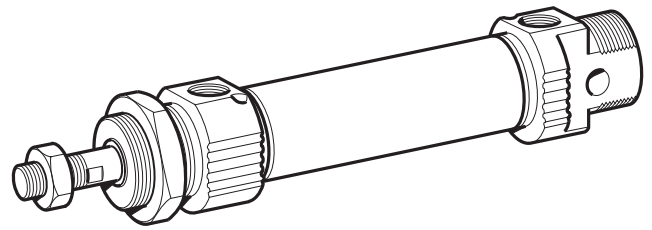

Single-acting

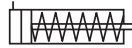

Cyl.bore mm	Stroke mm	Order code
10	10	P1A-S010SS-0010
	15	P1A-S010SS-0015
	25	P1A-S010SS-0025
	40	P1A-S010SS-0040
	50	P1A-S010SS-0050
	80	P1A-S010SS-0080
Conn. M5		
12	10	P1A-S012SS-0010
	15	P1A-S012SS-0015
	25	P1A-S012SS-0025
	40	P1A-S012SS-0040
	50	P1A-S012SS-0050
	80	P1A-S012SS-0080
Conn. M5		
16	10	P1A-S016SS-0010
	15	P1A-S016SS-0015
	25	P1A-S016SS-0025
	40	P1A-S016SS-0040
	50	P1A-S016SS-0050
	80	P1A-S016SS-0080
Conn. M5		
20	10	P1A-S020SS-0010
	15	P1A-S020SS-0015
	25	P1A-S020SS-0025
	40	P1A-S020SS-0040
	50	P1A-S020SS-0050
	80	P1A-S020SS-0080
Conn. G1/8		
25	10	P1A-S025SS-0010
	15	P1A-S025SS-0015
	25	P1A-S025SS-0025
	40	P1A-S025SS-0040
	50	P1A-S025SS-0050
	80	P1A-S025SS-0080
Conn. G1/8		

Single-acting



Cyl.bore mm	Stroke mm	Order code
16	10	P1A-S016TS-0010
	15	P1A-S016TS-0015
	25	P1A-S016TS-0025
	40	P1A-S016TS-0040
	50	P1A-S016TS-0050
	80	P1A-S016TS-0080
Conn. M5		
20	10	P1A-S020TS-0010
	15	P1A-S020TS-0015
	25	P1A-S020TS-0025
	40	P1A-S020TS-0040
	50	P1A-S020TS-0050
	80	P1A-S020TS-0080
Conn. G1/8		
25	10	P1A-S025TS-0010
	15	P1A-S025TS-0015
	25	P1A-S025TS-0025
	40	P1A-S025TS-0040
	50	P1A-S025TS-0050
	80	P1A-S025TS-0080
Conn. G1/8		

Double-acting

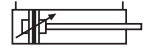

Cyl.bore mm	Stroke mm	Order code
16	15	P1A-S016MS-0015
	20	P1A-S016MS-0020
	25	P1A-S016MS-0025
	30	P1A-S016MS-0030
	40	P1A-S016MS-0040
	50	P1A-S016MS-0050
	80	P1A-S016MS-0080
	100	P1A-S016MS-0100
	125	P1A-S016MS-0125
	160	P1A-S016MS-0160
	200	P1A-S016MS-0200
	250	P1A-S016MS-0250
Conn. M5		
20	15	P1A-S020MS-0015
	20	P1A-S020MS-0020
	25	P1A-S020MS-0025
	30	P1A-S020MS-0030
	40	P1A-S020MS-0040
	50	P1A-S020MS-0050
	80	P1A-S020MS-0080
	100	P1A-S020MS-0100
	125	P1A-S020MS-0125
	160	P1A-S020MS-0160
	200	P1A-S020MS-0200
	250	P1A-S020MS-0250
Conn. G1/8		
25	15	P1A-S025MS-0015
	20	P1A-S025MS-0020
	25	P1A-S025MS-0025
	30	P1A-S025MS-0030
	40	P1A-S025MS-0040
	50	P1A-S025MS-0050
	80	P1A-S025MS-0080
	100	P1A-S025MS-0100
	125	P1A-S025MS-0125
	160	P1A-S025MS-0160
	200	P1A-S025MS-0200
	250	P1A-S025MS-0250
Conn. G1/8		
20	320	P1A-S020MS-0320
	400	P1A-S016MS-0400
	500	P1A-S016MS-0500

Cylinders are supplied complete with neck mounting and piston rod nuts.

Cylinders with Through piston rods are supplied with two piston rod nuts and one neck mounting nut.

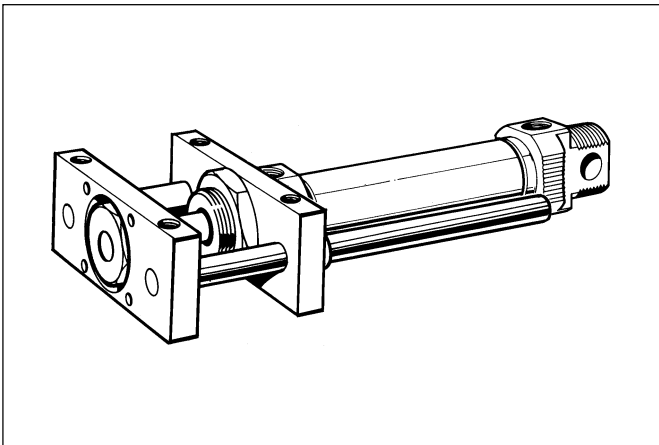

Technical data

Working medium	dry, filtered compressed air
Working pressure	max. 10 bar
Working temperature	-20 °C to +80 °C

Materials, guide device

Mounting flanges	Black anodized aluminium
Neck nut	Galvanized steel 8.8
Mounting plate	Surface treated steel, black
Flexible coupling	Stainless steel, X 10 CrNiS 18 9
Guides	Stainless steel, X 10 CrNiS 18 9
Guide bearings	Lubricant-charged plastic
Locking screws	Surface treated steel

Other data according to the base cylinder.

External guide device

Mini ISO cylinders can be fitted with an external guide unit to prevent the piston from turning. It guides the piston rod and enables the cylinder to resist turning moments on the piston rod and/or greater side loads.

The device consists of a substantial mounting plate and two guides that run along the sides of the cylinder in two bearing support guide sleeves. The mounting plate, which has pre-drilled mounting holes, is connected to the piston rod by means of a flexible coupling that prevents stresses from being transferred to the cylinder. The device is secured to the front end cover of the cylinder by a flange mounting and nut.

The device is available for 20 and 25 mm diameter cylinders, with stroke lengths from 10 to 250 mm. It is normally supplied factory-fitted (see the ordering data on page 7 for details of ordering), but can also be supplied separately to special order.

Dimensions

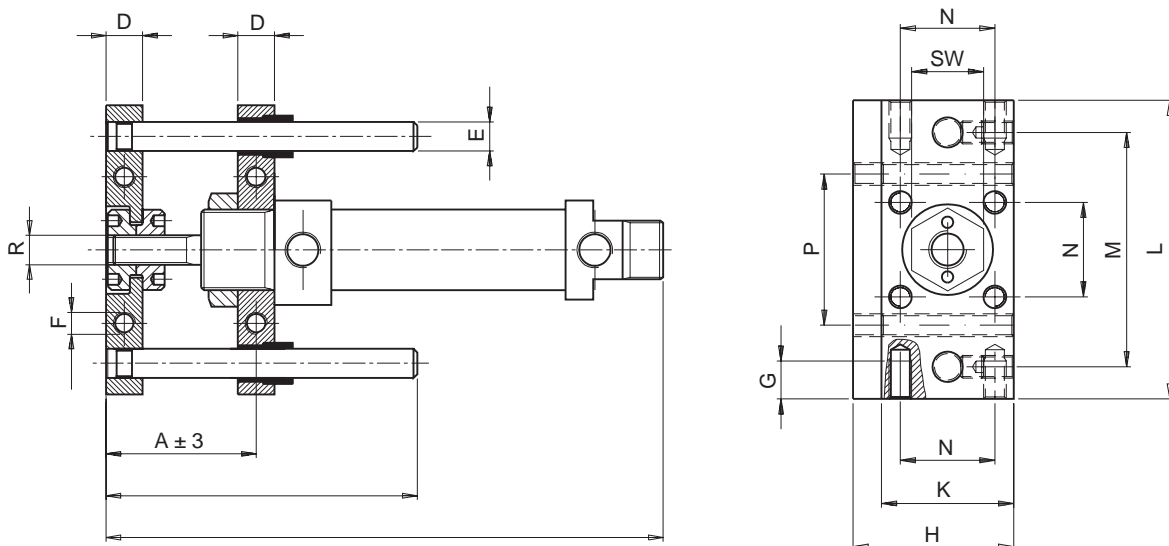

Cylinder bore mm	A mm	B mm	C mm	D mm	E mm	F	G mm	H mm	K mm	L mm	M mm	N mm	P mm	R	SW mm
20	41	60	133	10	8	M6	10	42,5	35	80	62	25	40	M8	19
25	47	60	142	10	8	M6	10	42,5	35	80	62	25	40	M10x1,25	19

Combinations

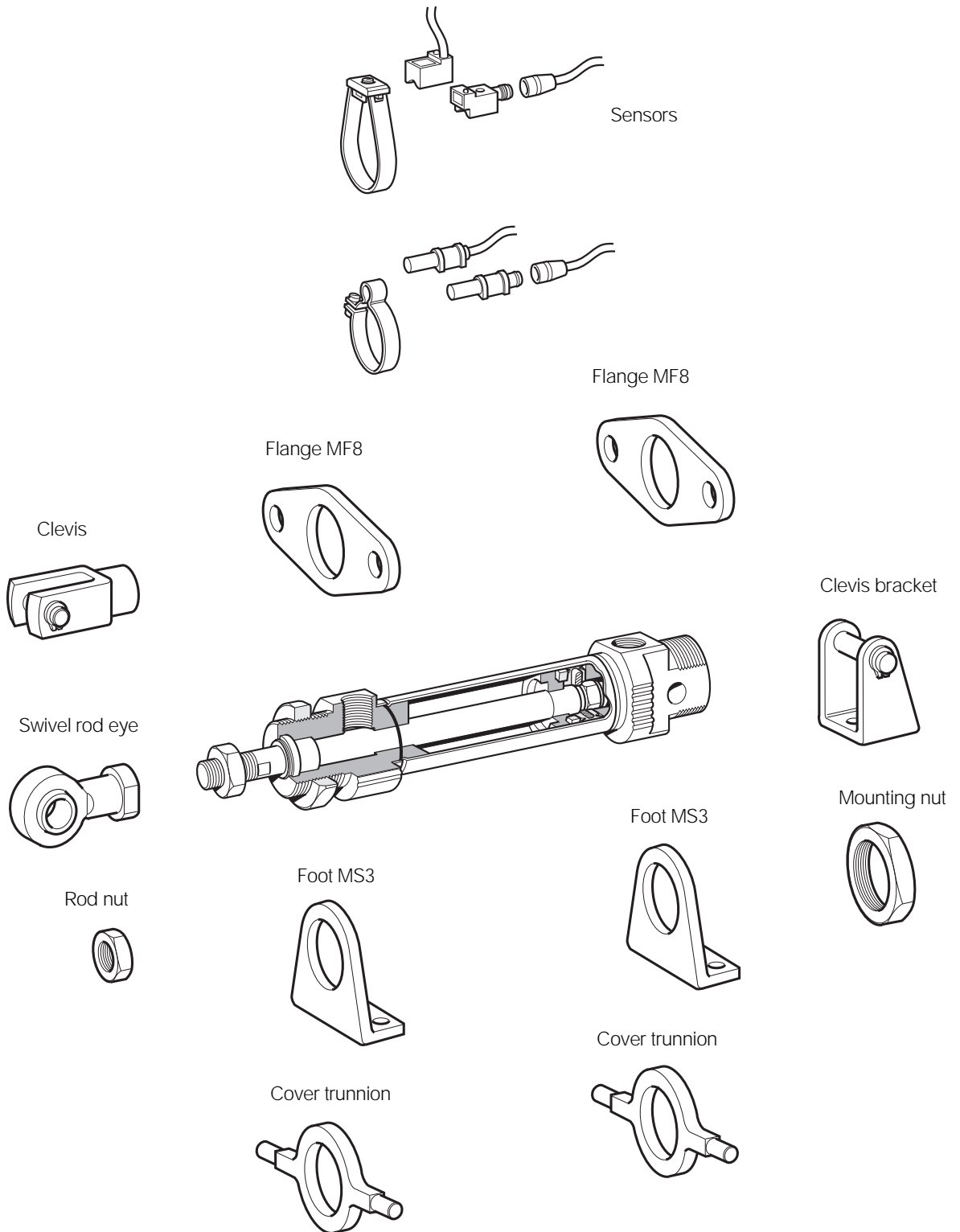

Cylinder mountings

Type	Description	Cyl. bore Ø mm	Weight kg	Order code
------	-------------	-------------------	--------------	------------

Flange-MF8

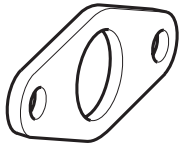

Intended for fixed attachment of the cylinder. The flange is designed for mounting on the front or rear end-covers.

Material:
Surface-treated steel

10	0,012	P1A-4CMB
12-16	0,025	P1A-4DMB
20-25	0,045	P1A-4HMB

Cylinder Ø mm	A mm	B mm	C mm	D mm	E mm	F mm
10	4,5	30	40	22	3	13
12-16	5,5	40	52	30	4	18
20	6,6	50	66	40	5	19
25	6,6	50	66	40	5	23

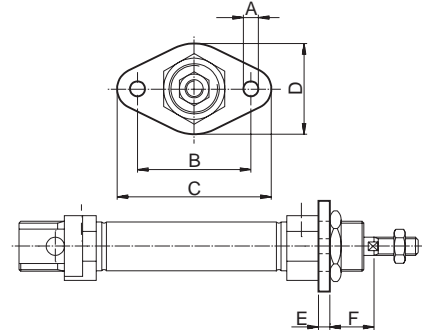

Foot-MS3

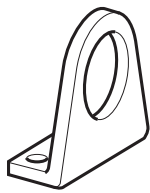

Intended for fixed attachment of the cylinder. The bracket is designed for mounting on the front or rear end-covers.

Material:
Surface-treated steel

10	0,020	P1A-4CMF
12-16	0,040	P1A-4DMF
20-25	0,080	P1A-4HMF

Cylinder Ø mm	A mm	B mm	C mm	D mm	E mm	F mm	G mm	H mm	I mm
10	4,5	16	25	35	3	24	26	16	11
12-16	5,5	20	32	42	4	32	32,5	20	14
20	6,5	25	40	54	5	36	45	25	17
25	6,5	25	40	54	5	40	45	25	17

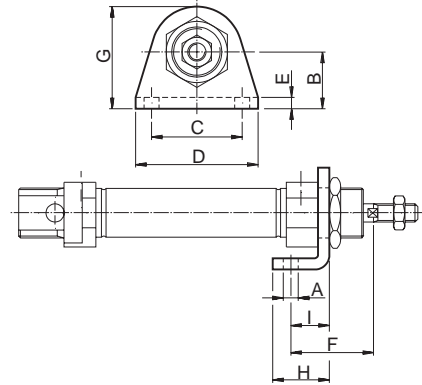

Cover trunnion

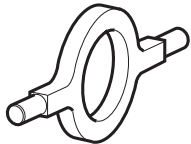

Intended for articulated mounting of the cylinder. The flange is designed for mounting on the front or rear end-covers.

Material:
Stainless steel, DIN X 10 CrNiS 18 9

10	0,014	P1A-4CMJ
12-16	0,033	P1A-4DMJ
20-25	0,037	P1A-4HMJ

Cylinder Ø mm	A mm	B mm	C mm	D mm	E mm	F mm	G mm	H mm
10	12,5	26	38	20	8	4	6	10
12-16	16,5	38	58	25	10	6	8	14
20	22,5	46	66	30	10	6	8	16
25	22,5	46	66	30	10	6	8	20

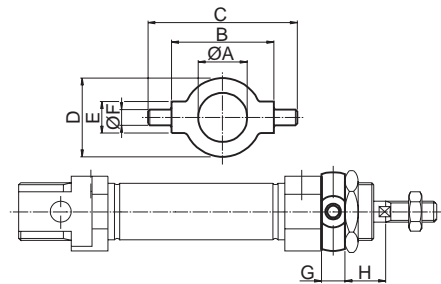

Mounting nut

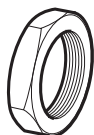

Intended for fixed mounting of the cylinder. Cylinders are supplied complete with one mounting nut.

Material:
Galvanized steel

10	0,009	9127385101
12-16	0,018	9127385102
20-25	0,042	9127385103

Cylinder Ø mm	A mm	B mm	C
10	16	3	M12x1,25
12-16	20	4	M16x1,50
20-25	27	5	M22x1,50

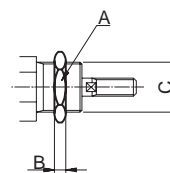

Cylinder mountings

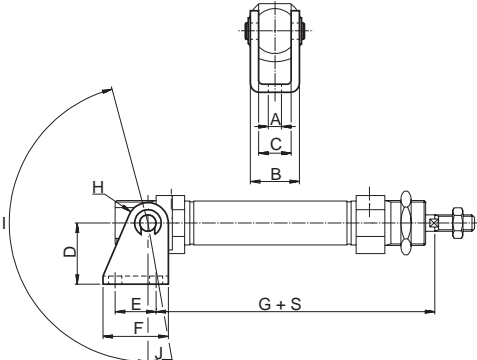
Type	Description	Cyl. bore Ø mm	Weight kg	Order code						
Clevis bracket 	Intended for articulated mounting of the cylinder. Supplied with shaft for mounting on the rear end cover. Material: Bracket: stainless steel, DIN X 5 CrNi 18 10 Pin: tempered stainless steel, DIN X 20 Cr 13 Locking rings: stainless steel, DIN X 5 CrNi 18 10	10	0,020	P1S-4CMT						
		12-16	0,040	P1S-4DMT						
		20-25	0,080	P1S-4HMT						
										
Cylinder Ø mm	A mm	B mm	C mm	D mm	E mm	F mm	G mm	H mm	I °	J °
10	4,5	13	8	24	12,5	20	65,3	5	160	17
12	5,5	18	12	27	15	25	73	7	170	15
16	5,5	18	12	27	15	25	80	7	170	15
20	6,5	24	16	30	20	32	91	10	165	10
25	6,5	24	16	30	20	32	100	10	165	10

S=stroke

Clevis

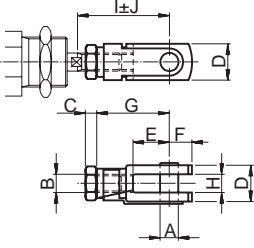
	According to ISO 8140 Intended for articulated mounting of the cylinder. This mounting is adjustable in the axial direction. Supplied complete with pin. Material: Galvanized steel	10	0,007	P1A-4CRD								
		12-16	0,022	P1A-4DRD								
		20	0,045	P1A-4HRD								
		25	0,095	P1A-4JRD								
												
Cylinder Ø mm	A mm	B mm	C mm	D mm	E mm	F mm	G mm	H mm	I mm	J mm	K mm	L mm
10	4	M4	2,2	8	8	5	16	4	22	2		
12-16	6	M6	3,2	12	12	7	24	6	31	3		
20	8	M8	4	16	16	10	32	8	40,5	3,5		
25	10	M10x1,25	5	20	20	12	40	10	49	3		

Swivel rod eye

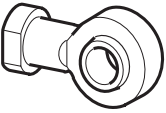
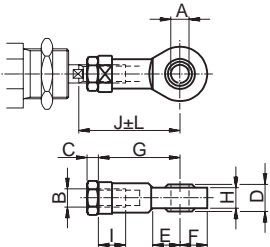
	According to ISO 8139 Intended for articulated mounting of the cylinder. This mounting is adjustable in the axial direction. Material: Swivel rod eye: Galvanized steel Ball: hardened steel	10	0,017	P1A-4CRT								
		12-16	0,025	P1A-4DRT								
		20	0,045	P1A-4HRT								
		25	0,085	P1A-4JRT								
												
Cylinder Ø mm	A mm	B mm	C mm	D mm	E mm	F mm	G mm	H mm	I mm	J mm	K mm	L mm
10	5	M4	2,2	8	10	9	27	6	8	33	9	2
12-16	6	M6	3,2	9	10	10	30	6,8	9	38,5	11	1,5
20	8	M8	4	12	12	12	36	9	12	46	14	2
25	10	M10x1,25	5	14	14	14	43	10,5	15	52,5	17	2,5

Rod nut

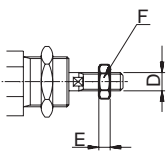
	Intended for fixed mounting on the piston rod. Cylinders are supplied complete with one rod nut. (cylinders with through piston rod are supplied with two rod nuts.) Material: Galvanized steel	10	0,001	0261110600
		12-16	0,002	0261210800
		20	0,005	0261211000
		25	0,007	9128985601
				
Cylinder Ø mm	D mm	F mm	E mm	
10	M4	7	2,2	
12-16	M6	10	3,2	
20	M8	13	4	
25	M10x1,25	17	5	

Reed switch sensors

The reed switch sensors incorporate a well-proven, universal-voltage, compact reed switch element, making them suitable for a wide range of applications. They can work with electronic control systems or conventional relay systems. No environment is too severe.

Technical data

Design	Reed
Output	Making
Voltage range, P1A-2XRL	110 VAC/VDC
Voltage range, P1A-2XSH	60 VAC/VDC
Max voltage drop	2,8 V
Max load current	180 mA
Max breaking power (resistive)	10 W
Min actuating distance	5 mm
Hysteresis	2 mm
Repeatability accuracy	±0,2 mm
Max on/off switching frequency	500 Hz
Max on/off switching time	1 ms
Encapsulation, P1A-2XRL	IP 67
Encapsulation, P1A-2XSH	IP 65
Temperature range	-30 °C to +80 °C
Indication	LED
Shock resistance	30 g
Material, housing	Nylon 66
Material, mould	Epoxy
Cable	PVC 2x0,2 mm ²
Cable incl. female part connector	PVC 2x0,2 mm ²
Mounting	Mounting yoke
Material, mounting	Stainless steel
Material, screw	Stainless steel
Connector	Diam. 8 mm snap on

Ordering data

Order code	Cylinder bore mm	Output	Cable length	Weight kg
------------	------------------	--------	--------------	-----------

Reed sensors

P1A-2XRL	10-25	making	3 m	0,055
P1A-2XSH	10-25	making	*	0,002

Mountings for sensors

P1A-2CCB	10	0,002
P1A-2DCB	12	0,0025
P1A-2FCB	16	0,003
P1A-2HCB	20	0,004
P1A-2JCB	25	0,005

Cable for sensors

9126344341**	3 m	0,055
9126344342**	10 m	0,175

*) Cable shall be ordered separately.

**) Cable including female part connector, for sensor.

Reed sensor symbol

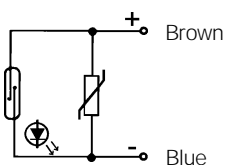

Electronic sensors

These sensors are of solid-state type, with no moving parts. Short-circuit and transient protection is incorporated as standard. The integral electronics make these sensors suitable for applications with very high switching frequencies.

Technical data

Design	Hall element
Output	PNP resp. NPN, N.O.
Voltage range	10-30 VDC
Max permissible ripple	10%
Max voltage drop	≤0,5 V at 100 mA
Max load current, P1A-2XMK, LK	150 mA
P1A-2XHK, EK, JH, FH	100 mA
Max breaking power (resistive)	6 W
Internal consumption	<30 mA at 30 V
Min actuating distance	5 mm
Hysteresis	1,1 - 1,3 mm
Repeatability accuracy	±0,1 mm
Max on/off switching frequency	1 kHz
Max on/off switching time	0,8/3,0 μs
Encapsulation, P1A-2XJH, FH	IP 65
Encapsulation, P1A-2XHK, EK, MK, LK	IP 67
Temperature range	-10 °C to +60 °C
Indication	LED
Shock resistance	40 g
Material, housing	Polyamid 11
Material, mould	Epoxy
Cable	PVC 3x0,15 mm ²
Cable incl. female part connector	PVC 3x0,15 mm ²
Connector	Diam. 8 mm snap on
Mounting	Mounting yoke
Material, mounting	Acetal/Stainless steel
Material, screw	Stainless steel

Ordering data

Order code	Cylinder bore mm	Output	Cable length	Weight kg
------------	------------------	--------	--------------	-----------

Electronic sensors

P1A-2XMK , 90°	10-25	PNP, N.O.	2 m	0,040
P1A-2XLK , 90°	10-25	NPN, N.O.	2 m	0,040
P1A-2XHK	10-25	PNP, N.O.	2 m	0,010
P1A-2XEK	10-25	NPN, N.O.	2 m	0,010
P1A-2XJH	10-25	PNP, N.O.	*	0,015
P1A-2XFH	10-25	NPN, N.O.	*	0,015

Mountings for sensors

P1A-2CCC	10	0,005
P1A-2DCC	12	0,005
P1A-2FCC	16	0,008
P1A-2HCC	20	0,008
P1A-2JCC	25	0,010

Cable for sensors

9126344341**	3 m	0,055
9126344342**	10 m	0,175

Electronic sensor symbol

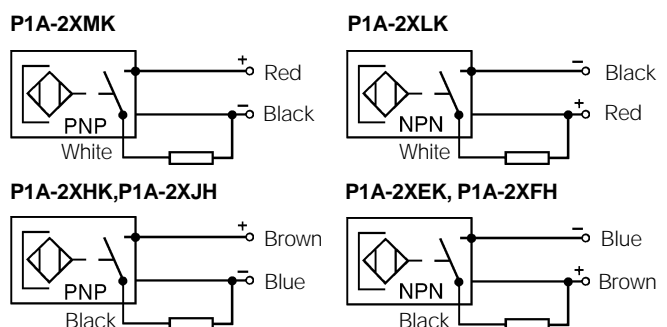

Dimensions

Reed sensors

P1A-2XRL

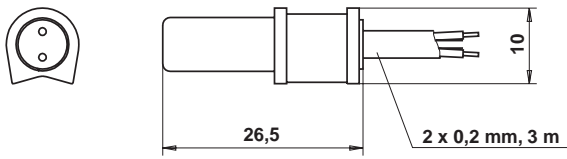

P1A-2XSH

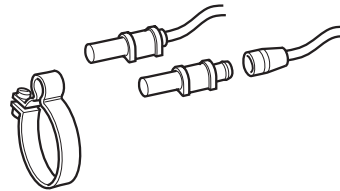
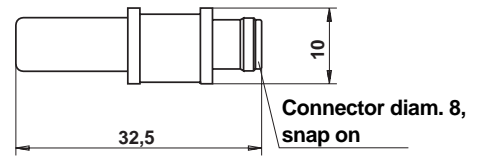

Electronic sensors

P1A-2XHK and P1A-2XEK

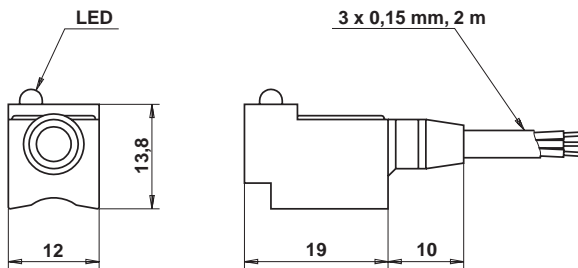

P1A-2XJH and P1A-2XFH

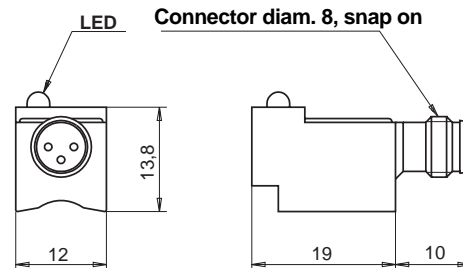

P1A-2XMK and P1A-2XLK

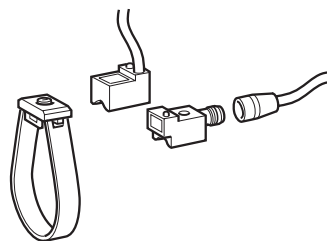
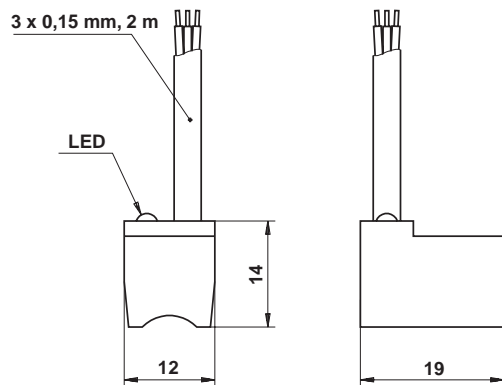

Service and Replacement Parts

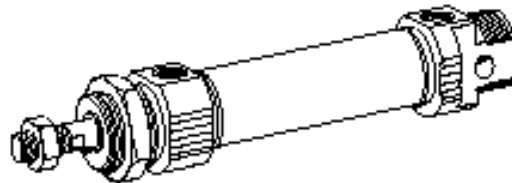

P1A Mini ISO Cylinders

Non-repairable, **replace complete cylinder**

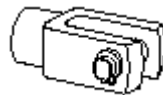

Bore Size	Piston rod clevis	Swivel rod eye
10mm	P1A-4CRC	P1A-4CRS
12mm	P1A-4DRC	P1A-4DRS
16mm		
20mm	P1A-4HRC	P1A-4HRS
25mm	P1A-4JRC	P1A-4JRS