

851 Series



Applications

Former connector for military applications. Now used in the fields of professional and general electronics.

Standards

MIL-C 26482 G Series 1
 NFC 93422-He 301 B
 VG 95328
 BS 9522 F 0017
 GAM T1 list
 QPL approved (solder version)

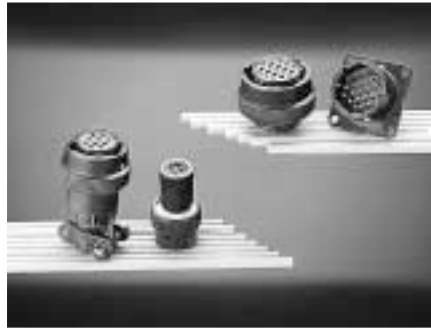

Description

- Bayonet coupling
- Environmental and hermetic versions
- Solder, crimp, straight spills and wire wrap versions
- Thermocouple contacts available
- Cadmium free plating (Zinc Cobalt) version

Characteristics

Mechanical

- Shell :
 - environmental version : aluminum alloy plating
 - olive green cadmium
 - black anodized
 - white cadmium
 - satin finish bright nickel
 - zinc cobalt (olive green)
 - hermetic version : steel
 - plating : - iridescent yellow cadmium, nickel
- Insulator :
 - front section : neoprene elastomer (85 shore)
 - rear section : neoprene elastomer (40 shore)
- Contact :
 - crimp : inserted and removed from rear of insulator retained by metallic clip ; solder and straight spills : non removable ; wire wrap : removable or not removable
 - material : copper alloy
 - plating : gold overall or gold plated active zone and tin/lead plated termination
 - min retention force of contacts in insulator

contact size	crimp	solder straight spill ww
20 (Ø 1 mm)	≥ 68 N	≥ 68 N
16 (Ø 1.6 mm)	≥ 113 N	≥ 113 N

- Mechanical endurance : 500 cycles (full mating-unmating)

Electrical

- Dielectric withstanding voltage :
 - at standard pressure : mated and unmated connectors
 - 1 500 Vrms between size 20 contacts (service 1)
 - 2 300 Vrms between size 16 contacts (service 2)
 - 1 500 Vrms between mixed size 20 and 16 contacts (service 1)
 - at reduced pressure (10 mbar) : connectors mated and unmated
 - 200 Vrms between size 20 contacts (service 1)
 - 300 Vrms between size 16 contacts (service 2)
- Insulation resistance : ≥ 5 000 MΩ under 500 Vdc
- Current rating per contact :
 - size 20 : 7.5 A
 - size 16 : 13 A

- Contact resistance :
 - environmental version :
 - size 20 : 4 mΩ
 - size 16 : 3 mΩ
 - hermetic version :
 - size 20 : 30 mΩ
 - size 16 : 14 mΩ
- Shielding : 70 dB to 5 MHz
40 dB to 100 MHz

Climatic

- Working temperature : -55°C to +125°C
- Sealing :
 - crimp contact version, 1 bar differential pressure, leakage ≤ 8 cm³/hr
 - solder contact version, 2 bar differential pressure, leakage ≤ 16 cm³/hr
- Hermeticity : 1 bar differential pressure leakage ≤ 2,8 mm³/hr
- Chemical resistance :
 - to MIL-C 26482 G Series 1 and NFC 93422-HE 301 B code A
- Resistance to salt spray : 48 hours at environmental temperature
- Damp heat : 21 days
- Vibration : to NFC 20-616

Ordering information - Environmental connectors

basic series	solder version	851 - 00	E	8 -	3A	P	•	50	•••
	crimp version	851 - 00	R	8 -	3A	P	•	50	•••
shell type	solder	crimp							
	00	00	-						
	01	01	-						
	02E	02R	-						
	07	07	-						
	07A		-						
	06	06	-						
	08	08	-						
	36		-						
	76	76	-						
backshell type	see table next page								
shell size	8 - 10 - 12 - 14 - 16 - 18 - 20 - 22 - 24								
contact layout	see table p 20								
contact type	P = male - S = female								
orientation	normal (not included in part number) w, x, y, z, see table p 21								
obligatory suffix	50	gold plated crimp contacts - solder contacts size 20 - contacts with a gold plated active zone and tin plated terminations - other gold plated terminations							
	51	solder contacts gold plated size 20							
	52	zinc cobalt olive green plated (contacts : idem specif. 50)							
specification	-	olive green cadmium plate (without specification)							
	02	white cadmium plate							
	29	black anodized (solder contacts)							
	031	black anodized (crimp contacts)							
	44	nickel plate							
	38	nickel plate							
	42	olive green cadmium plate } backshell type T* and RT*							

851 Series



Backshell type

solder	crimp	shells backshell	solder version							crimp version						
			00	01	07	06	08	36	76	00	01	07	06	08	36	76
E	R	backnut	•	•	•	•	-	-	-	•	•	•	•	-	-	-
EC	RC	straight cable clamp	•	•	•	•	-	-	-	•	•	•	•	-	-	-
EC	RC	90° cable clamp	-	-	-	-	•	-	-	-	-	-	•	-	-	
AC		straight cable clamp without grommet	•	•	•	•	-	-	-	-	-	-	-	-	-	
P	RP	straight backshell for potting	•	•	•	•	-	-	-	•	•	•	•	-	-	-
P	RP	90° backshell for potting	-	-	-	-	•	-	-	-	-	-	•	-	-	
A	RA	straight adapter	•	•	-	•	-	•	-	•	•	-	•	-	•	-
T	RT	straight backshell for heatshrink sleeving	•	•	•	•	-	-	-	•	•	•	•	-	-	-
M	RM	straight removable backshell for heatshrink sleeving	•	•	-	•	-	-	-	•	•	-	•	-	-	-
*T	*RT	straight removable backshell for screen termination and heatshrink sleeving	•	•	•	-	-	•	-	•	•	•	-	-	•	-
G	RG	straight removable backshell for screen termination and heatshrink sleeving	•	•	•	-	-	•	-	•	•	•	-	-	•	-
J		straight backshell with sealing gland	•	•	-	•	-	-	-	-	-	-	-	-	-	-
JC		straight backshell with sealing gland and cable clamp	•	•	-	•	-	-	-	-	-	-	-	-	-	-
U	RU	short backshell for screen termination and heatshrink sleeving	-	-	-	-	-	-	•	-	-	-	-	-	-	•
Z	RZ	straight adapter for electrical pitch access	-	-	-	•	-	-	-	-	-	-	•	-	-	-

Hermetic connectors

basic series	851 -02H 8 -3A P • 50 ••
shell type	02H - square flange receptable 07H - jam nut receptable IH - solder fixing receptable
shell size	8 - 10 - 12 - 14 - 16 - 18 - 20 - 22 - 24
contact layout	see table p 20
contact type	P = male only
orientation	N normal (not included in part number) w, x, y, z, see table p 21
obligatory suffix	50 - pre-tinning contact size 20 (termination area), gold plating for other contacts 51 - gold plating for size 20 contacts
specification	44 - 02H and 07H, yellow cadmium plating. IH, nickel (without specification)

851 Series



Straight spills and wire wrap connectors

basic series	851 -02E 8 -3A P • 50 16
shell type	02E - square flange receptable not accepting backshell 07A - jam nut receptable not accepting backshell
shell size	8 - 10 - 12 - 14 - 16 - 18 - 20 - 22 - 24
contact layout	see table p 20
contact type	P = male - S = female
orientation	N normal (not included in part number) w, x, y, z, see table p 21
obligatory suffix	50 - pre-tinning for straight spill size 20 contacts (termination area), gold plating for other contacts 51 - gold plating for straight spill contacts size 20 52 - zinc cobalt olive green plated (contacts : idem specif. 50)
specification	
straight spill	16 olive green cadmium plated body - Ø 1 mm contact, Ø 0,6 mm terminal 40 white cadmium plated body - Ø 1,6 mm contact, Ø 1 mm terminal - Ø 1 mm contact, Ø 0,6 mm terminal - Ø 1,6 mm contact, Ø 1 mm terminal
wire wrap	34 non-bonded contacts, olive green cadmium plated shell 34A bonded contacts, olive green cadmium plated shell

Cross reference list

851 version with crimp contacts (olive green cadmium plating) connectors with backshells

FCI Souriau	NFC 93422 (HE 301 B)	MIL-C 26482 G Series I	VG 95328
851 00 R 50 ..	HE 301 B 00 R 1A	* MS 3120 E	VG 95328 A
851 00 RC 50 ..	HE 301 B 00 RC 1A	* MS 3120 F	VG 95328 B
851 00 RP 50 ..	HE 301 B 00 RP 1A	* MS 3120 P	
851 00 RG 50 ..			VG 95328 R
851 00 RA 50 ..	HE 301 B 00 RA 1A		
851 01 R 50 ..	HE 301 B 01 R 1A	* MS 3121 E	
851 01 RC 50 ..	HE 301 B 01 RC 1A	* MS 3121 F	
851 01 RP 50 ..	HE 301 B 01 RP 1A	* MS 3121 P	
851 01 RA 50 ..	HE 301 B 01 RA 1A		
851 02 R 50 ..	HE 301 B 02 R 1A	* MS 3122 E	VG 95328 C
851 06 R 50 ..	HE 301 B 06 R 1A	* MS 3126 E	
851 06 RC 50 ..	HE 301 B 06 RC 1A	* MS 3126 F	VG 95328 K
851 06 RP 50 ..	HE 301 B 06 RP 1A	* MS 3126 P	
851 06 RT 50 ..			VG 95328 J
851 06 RA 50 ..	HE 301 B 06 RA 1A		
851 36 RG 50 ..			VG 95328 M
851 36 RA 50 ..			VG 95328 N
851 07 R 50 ..	HE 301 B 07 R 1A	* MS 3124 E	VG 95328 D
851 07 RC 50 ..	HE 301 B 07 RC 1A	* MS 3124 F	VG 95328 E
851 07 RP 50 ..	HE 301 B 07 RP 1A	* MS 3124 P	
851 07 RT 50 ..			VG 95328 S
851 07 RG 50 ..			VG 95328 T
851 76 RU 50 ..			VG 95328 U
851 08 RC 50 ..	HE 301 B 08 RC 1A		
851 08 RP 50 ..	HE 301 B 08 RP 1A		

* Not QPL.

Other plating

plating	FCI Souriau		NFC 93422 (HE 301 B)
	solder version	crimp version	
white cadmium	851 5002	851 5002	HE 301 B 2A
black anodized	851 5029	851 50031	HE 301 B 4A
nickel	851 5044	851 5044	HE 301 B 5A

851 Series



851 version with solder contacts (olive green cadmium plating) connectors with backshells











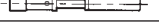



FCI Souriau	NFC 93422 (HE 301 B)	MIL-C 26482 G Series I	VG 95328
851 00 E 50 ..	HE 301 B 00 E 1A	MS 3110 E	
851 00 EC 50 ..	HE 301 B 00 EC 1A	MS 3110 F	
851 00 AC 50 ..	HE 301 B 00 AC 1A		
851 00 P 50 ..	HE 301 B 00 P 1A	MS 3110 P	
851 00 A 50 ..	HE 301 B 00 A 1A		
851 00 J 50 ..	HE 301 B 00 J 1A		
851 00 JC 50 ..		MS 3110 J	
851 01 E 50 ..	HE 301 B 01 E 1A	MS 3111 E	
851 01 EC 50 ..	HE 301 B 01 EC 1A	MS 3111 F	
851 01 AC 50 ..	HE 301 B 01 AC 1A		
851 01 P 50 ..	HE 301 B 01 P 1A	MS 3111 P	
851 01 A 50 ..	HE 301 B 01 A 1A		
851 01 J 50 ..	HE 301 B 01 J 1A		
851 01 JC 50 ..		MS 3111 J	
851 02 E 50 ..	HE 301 B 02 E 1A	MS 3112 E	VG 95328 H
851 06 E 50 ..	HE 301 B 06 E 1A	MS 3116 E	
851 06 EC 50 ..	HE 301 B 06 EC 1A	MS 3116 F	
851 06 AC 50 ..	HE 301 B 06 AC 1A		
851 06 P 50 ..	HE 301 B 06 P 1A	MS 3116 P	
851 06 A 50 ..	HE 301 B 06 A 1A		
851 06 J 50 ..	HE 301 B 06 J 1A		
851 06 JC 50 ..		MS 3116 J	
851 08 EC 50 ..	HE 301 B 08 EC 1A		
851 08 P 50 ..	HE 301 B 08 P 1A		
851 07 E 50 ..	HE 301 B 07 E 1A	MS 3114 E	
851 07 EC 50 ..	HE 301 B 07 EC 1A	MS 3114 F	
851 07 AC 50 ..	HE 301 B 07 AC 1A		
851 07 P 50 ..	HE 301 B 07 P 1A	MS 3114 P	
851 07 A 50 ..	HE 301 B 07 A 1A		

851 hermetic version

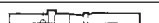

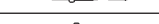

FCI Souriau	NFC 93422 (model HE 301 B)	MIL-C 26482 G Series I	VG 95328
851 02 H P.50	HE 301 B 02 H P.3A		
851 07 H P.50	HE 301 B 07 H P.3A	* MS 3114 H P.	VG 95328 F
851 IH P.50	HE 301 B 1 H P.3A	* MS 3113 H P.	VG 95328 G

* Not QPL.

Contacts - Crimp contacts

contact type			contact size	part numbers	section in mm ²	gauge AWG	Ø over insulation min/Max (mm)			
standard	male	for contact layouts 82, 83 84 and 12.14	20	8500-9573	0.21 to 0.93	24 to 18	1.20 / 2.11			
	female			8500-9213						
	male	for other contact layouts		8500-697	0.93 to 1.91	18 to 14				
	female			8500-1758A						
	male			16	8500-1300	0.93 to 1.91		18 to 14	1.60 / 2.80	
	female			8500-9331						
reducing sleeve			20	8500-781	0.26 to 0.21	30 to 24				
			16	8500-1985	0.60	20				
thermocouple	chromel	male	20	8500-809	0.21 to 0.93	24 to 18	1.20 / 2.11			
	alumel			8500-812						
	chromel	female		8500-2054	0.93 to 1.91	18 to 14				
	alumel			8500-2055						
	chromel	male		16	8500-1053	0.93 to 1.91		18 to 14	1.60 / 2.80	
	alumel			8500-1058						
	chromel	female		8500-1054	1.91	14				
	alumel			8500-1059						

Wire wrap contacts

contact type	contact size	part numbers	diagonals	gauge AWG	number of wraps	
male	20	8500-4220	0.78 to 0.85	26-28-30	3	
female		8500-9351	0.78 to 0.85	26-28-30	3	
male	16	8500-4304	1.55 to 1.70	20-22-24-26	3	
female		8500-4305	1.55 to 1.70	20-22-24-26	3	

851 Series



Contact layouts

Viewed from front face of male insulator

shells 8	2 2 Ø 1 (# 20)	3 3 Ø 1 (# 20)	3A OU 98 3 Ø 1 (# 20)	4 4 Ø 1 (# 20)	33 3 Ø 1 (# 20)	
10	6 6 Ø 1 (# 20)	7 7 Ø 1 (# 20)	98 6 Ø 1 (# 20)			
12	3 3 Ø 1,6 (# 16)	8 8 Ø 1 (# 20)	10 10 Ø 1 (# 20)	2 2 Ø 1,6 (# 16)	14 14 Ø 1 (# 20)	
14	5 5 Ø 1,6 (# 16)	12 8 Ø 1 (# 20) 4 Ø 1,6 (# 16)	15 14 Ø 1 (# 20) 1 Ø 1,6 (# 16)	18 18 Ø 1 (# 20)	19 19 Ø 1 (# 20)	
16	8 8 Ø 1,6 (# 16)	23 22 Ø 1 (# 20) 1 Ø 1,6 (# 16)	26 26 Ø 1 (# 20)	SN 0775 7 Ø 1 (# 20) 3 Ø 1,6 (# 16) 1 coax 50Ω		
18	11 11 Ø 1,6 (# 16)	32 32 Ø 1 (# 20)	30 29 Ø 1 (# 20) 1 Ø 1,6 (# 16)			
20	16 16 Ø 1,6 (# 16)	39 37 Ø 1 (# 20) 2 Ø 1,6 (# 16)	41 41 Ø 1 (# 20)	24 24 Ø 1 (# 20)	25 25 Ø 1 (# 20)	27 27 Ø 1 (# 20)
22	21 21 Ø 1,6 (# 16)	36 36 Ø 1 (# 20)	55 55 Ø 1 (# 20)	32 32 Ø 1 (# 20)	34 34 Ø 1 (# 20)	
24	61 61 Ø 1 (# 20)	<ul style="list-style-type: none"> ■ solder contact layouts (QPL) □ solder contact layouts + solder contact layouts without grommet ▲ crimp contact layouts ■ SHTP ● hermetic version contact layouts ◆ straight spills contact layouts ○ wire wrap contact layouts 				

851 Series



Polarization - insulator rotated inside metal body

Viewed from front face of male insulator (receptacle or plug)

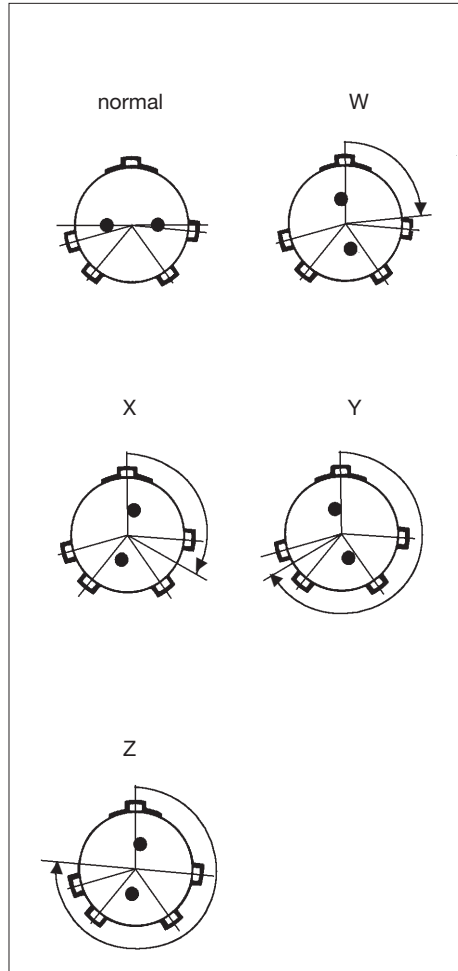

shell	layout	angle in degrees				NFC 93422 HE 30 1B		MIL-C 26482G Serie 1		service 1 1500 Vrms	service 2 2300 Vrms
		W	X	Y	Z	solder	crimp	solder	crimp		
8	2	58	122	—	—			•		X	
	3	60	210	—	—			•		X	
	3A (98)*	60	210	—	—			•	•	X	
	4	45	—	—	—			•		X	
	33	90	—	—	—		•	•	•	X	
10	6	90	—	—	—	•	•	•	•	X	
	7	—	—	—	—					X	
	98	90	180	240	270			•	•	X	
12	3	—	—	180	—	•	•	•	•		X
	8	90	112	203	292			•	•	X	
	10	60	155	270	295	•	•	•	•	X	
	2	—	—	—	—						X
	14	—	—	—	—			•		X	
14	5	40	92	184	273	•	•	•	•	X	
	12	43	90	—	—	•	•	•	•	X	
	15	17	110	155	234	•	•	•	•	X	
	18	15	90	180	270			•	•	X	
	19	30	165	315	—	•	•	•	•	X	
16	8	54	152	180	331	•	•	•	•		X
	23	158	270	—	—	•	•	•	•	X	
	26	60	—	275	338	•	•	•	•	X	
18	11	62	119	241	340	•	•	•	•		X
	32	85	138	222	265	•	•	•	•	X	
	30	180	193	285	350			•	•	X	
20	16	238	318	333	347	•	•	•	•		X
	39	63	144	252	333	•	•	•	•	X	
	41	45	126	225	—	•	•	•	•	X	
	24	70	145	215	290			•	•	X	
	25	72	144	216	288					X	
22	27	72	144	216	288		•		•	X	
	21	16	135	175	349	•	•	•	•		X
	36	72	144	216	288			•	•	X	
	55	30	142	226	314	•	•	•	•	X	
	32	72	145	215	288			•	•	X	
24	34	62	142	218	298			•	•	X	
	61	90	180	270	324	•	•	•	•	X	

* 8-98 layout W and non standard orientations

Dimensions - square flange receptacle with backnut

solder 00 E	HE 301 B 00 E MS 3110 E	crimp 00 R	HE 301 B 00 R MS 3120 E VG 95328 A	shell size	L Max		A	B Max	C Max	D Max	E	F Max	J
					solder	crimp							
00 E	HE 301 B 00 E MS 3110 E	00 R	HE 301 B 00 R MS 3120 E VG 95328 A	08	32.70	32.00	12.03	11.70	1.32	13.50	15.09	20.99	3.13
					1.287	1.260	.474	.461	.052	.531	.594	.826	.123
00 R	HE 301 B 00 R MS 3120 E VG 95328 A	00 R	HE 301 B 00 R MS 3120 E VG 95328 A	10	32.70	32.00	15.01	11.70	1.32	16.70	18.26	24.19	3.13
					1.287	1.260	.591	.461	.052	.657	.719	.952	.123
00 R	HE 301 B 00 R MS 3120 E VG 95328 A	00 R	HE 301 B 00 R MS 3120 E VG 95328 A	12	32.70	32.00	19.07	11.70	1.32	19.90	20.62	26.54	3.13
					1.287	1.260	.751	.461	.052	.783	.812	1.045	.123
00 R	HE 301 B 00 R MS 3120 E VG 95328 A	00 R	HE 301 B 00 R MS 3120 E VG 95328 A	14	32.70	32.00	22.25	11.70	1.32	23.40	23.00	28.89	3.13
					1.287	1.260	.876	.461	.052	.921	.906	1.137	.123
00 R	HE 301 B 00 R MS 3120 E VG 95328 A	00 R	HE 301 B 00 R MS 3120 E VG 95328 A	16	32.70	32.00	25.42	11.70	1.32	26.60	24.61	31.29	3.13
					1.287	1.260	1.001	.461	.052	1.047	.969	1.232	.123
00 R	HE 301 B 00 R MS 3120 E VG 95328 A	00 R	HE 301 B 00 R MS 3120 E VG 95328 A	18	32.70	32.00	28.60	11.70	1.32	29.50	26.97	33.69	3.13
					1.287	1.260	1.126	.461	.052	1.161	1.062	1.326	.123
00 R	HE 301 B 00 R MS 3120 E VG 95328 A	00 R	HE 301 B 00 R MS 3120 E VG 95328 A	20	34.50	33.40	31.77	14.35	2.15	32.70	29.36	36.89	3.13
					1.358	1.315	1.251	.565	.085	1.287	1.156	1.452	.123
00 R	HE 301 B 00 R MS 3120 E VG 95328 A	00 R	HE 301 B 00 R MS 3120 E VG 95328 A	22	34.50	33.40	34.95	14.35	2.15	36.00	31.75	39.99	3.13
					1.358	1.315	1.376	.565	.085	1.417	1.250	1.574	.123
00 R	HE 301 B 00 R MS 3120 E VG 95328 A	00 R	HE 301 B 00 R MS 3120 E VG 95328 A	24	34.50	33.40	38.12	15.20	2.15	39.10	34.92	43.15	3.81
					1.358	1.315	1.501	.598	.085	1.539	1.375	1.699	.150

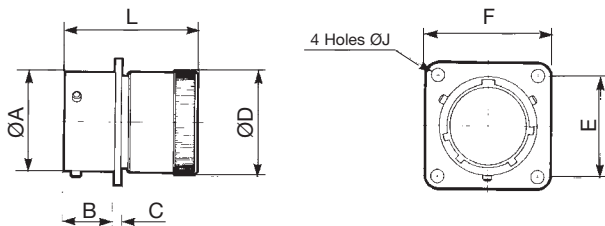

851 Series



Square flange receptacle with straight cable clamp

solder	00 EC HE 301 B 00 EC MS 3110 F	00 AC HE 301 B 00 AC	crimp	00 RC HE 301 B 00 RC MS 3120 F VG 95328 B	shell size	L Max		A	B Max	C Max	D Max	E	F Max	G	J
						solder	crimp								
08	48.00 1.890	47.30 1.862	12.03 .474	11.70 .461	1.32 .052	19.90 .783	15.09 .594	20.99 .826	3.50 .138	3.13 .123					
10	48.00 1.890	47.30 1.862	15.01 .591	11.70 .461	1.32 .052	21.50 .846	18.26 .719	24.19 .952	5.00 .197	3.13 .123					
12	48.00 1.890	47.30 1.862	19.07 .751	11.70 .461	1.32 .052	25.00 .984	20.62 .812	26.54 1.045	8.20 .323	3.13 .123					
14	48.00 1.890	47.30 1.862	22.25 .876	11.70 .461	1.32 .052	27.80 1.094	23.00 .906	28.89 1.137	10.00 .394	3.13 .123					
16	51.00 2.008	50.50 1.988	25.42 1.001	11.70 .461	1.32 .052	29.40 1.157	24.61 .969	31.29 1.232	13.00 .512	3.13 .123					
18	51.00 2.008	50.50 1.988	28.60 1.126	11.70 .461	1.32 .052	35.30 1.390	26.97 1.062	33.69 1.326	16.00 .630	3.13 .123					
20	53.00 2.087	51.50 2.028	31.77 1.251	14.35 .565	2.15 .085	35.30 1.390	29.36 1.156	36.89 1.452	16.00 .630	3.13 .123					
22	53.00 2.087	51.50 2.028	34.95 1.376	14.35 .565	2.15 .085	41.10 1.618	31.75 1.250	39.99 1.574	19.30 .760	3.13 .123					
24	53.00 2.087	51.50 2.028	38.12 1.501	15.20 .598	2.15 .085	42.40 1.669	34.92 1.375	43.15 1.699	20.60 .811	3.81 .150					

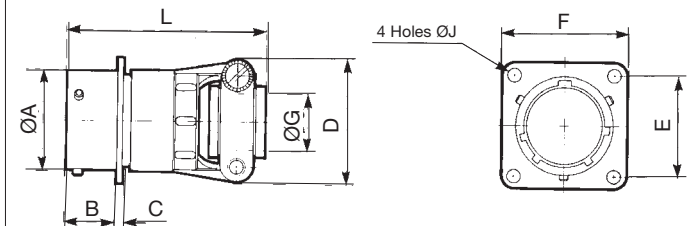

Square flange receptacle with straight backshell for potting

solder	00 P HE 301 B 00 P MS 3110 P	00 RP HE 301 B 00 RP MS 3120 P	shell size	L Max		A	B Max	C Max	D Max	E	F Max	G Max	J
				solder	crimp								
08	36.20 1.425	41.70 1.642	12.03 .474	11.70 .461	1.32 .052	15.34 .604	15.09 .594	20.99 .826	10.46 .412	3.13 .123			
10	36.20 1.425	41.70 1.642	15.01 .591	11.70 .461	1.32 .052	17.70 .697	18.26 .719	24.19 .952	13.55 .533	3.13 .123			
12	36.20 1.425	41.70 1.642	19.07 .751	11.70 .461	1.32 .052	21.69 .854	20.62 .812	26.54 1.045	13.96 .550	3.13 .123			
14	36.20 1.425	41.70 1.642	22.25 .876	11.70 .461	1.32 .052	23.90 .941	23.00 .906	28.89 1.137	17.42 .686	3.13 .123			
16	36.20 1.425	41.70 1.642	25.42 1.001	11.70 .461	1.32 .052	27.00 1.063	24.61 .969	31.29 1.232	20.56 .809	3.13 .123			
18	36.91 1.453	44.46 1.750	28.60 1.126	11.70 .461	1.32 .052	30.50 1.201	26.97 1.062	33.69 1.326	23.66 .931	3.13 .123			
20	43.80 1.724	50.93 2.005	31.77 1.251	14.35 .565	2.15 .085	33.65 1.325	29.36 1.156	36.89 1.452	23.92 .942	3.13 .123			
22	43.80 1.724	50.93 2.005	34.95 1.376	14.35 .565	2.15 .085	37.10 1.461	31.75 1.250	39.99 1.574	25.52 1.005	3.13 .123			
24	43.80 1.724	51.40 2.024	38.12 1.501	15.20 .598	2.15 .085	40.00 1.575	34.92 1.375	43.15 1.699	32.00 1.260	3.81 .150			

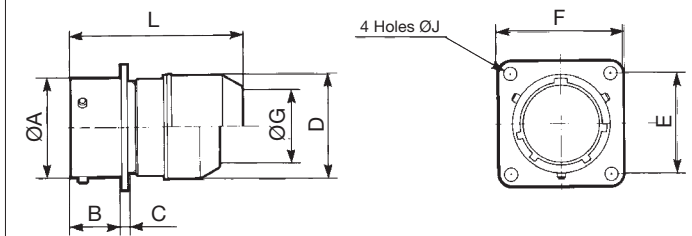

Square flange receptacle with straight adapter

solder	00 A HE 301 B 00A	00 RA HE 301 B 00 RA	shell size	L Max		A	B Max	C Max	D Max	E	F Max	G Max	J	K threading UNEF 2A
				solder	crimp									
08	41.00 1.614	12.03 .474	11.70 .461	1.32 .052	14.50 .571	15.09 .594	20.99 .826	9.10 .358	3.13 .123	1/2 18				
10	41.00 1.614	15.01 .591	11.70 .461	1.32 .052	18.70 .736	18.26 .719	24.19 .952	12.08 .476	3.13 .123	5/8 24				
12	41.00 1.614	19.07 .751	11.70 .461	1.32 .052	21.70 .854	20.62 .812	26.54 1.045	15.25 .600	3.13 .123	3/4 20				
14	41.00 1.614	22.25 .876	11.70 .461	1.32 .052	25.10 .988	23.00 .906	28.89 1.137	18.15 .715	3.13 .123	7/8 20				
16	41.00 1.614	25.42 1.001	11.70 .461	1.32 .052	28.13 1.107	24.61 .969	31.29 1.232	21.32 .839	3.13 .123	1-20				
18	41.00 1.614	28.60 1.126	11.70 .461	1.32 .052	31.38 1.235	26.97 1.062	33.69 1.326	24.32 .957	3.13 .123	1-3/16 18				
20	44.00 1.732	31.77 1.251	14.35 .565	2.15 .085	34.30 1.350	29.36 1.156	36.89 1.452	26.73 1.052	3.13 .123	1-3/16 18				
22	44.00 1.732	34.95 1.376	14.35 .565	2.15 .085	37.60 1.480	31.75 1.250	39.99 1.574	30.67 1.207	3.13 .123	1-7/16 18				
24	44.00 1.732	38.12 1.501	15.20 .598	2.15 .085	40.70 1.602	34.92 1.375	43.15 1.699	33.08 1.302	3.81 .150	1-7/16 18				

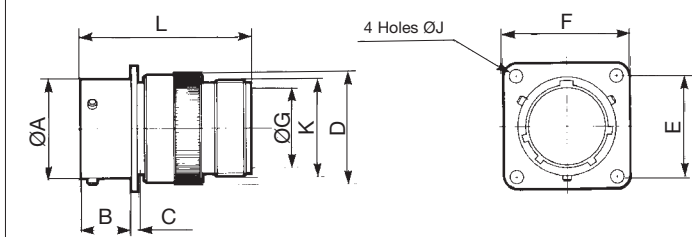

851 Series



Square flange receptacle with straight backshell for heatshrink sleeving

solder 00 T	crimp 00 RT	shell size	L Max		A	B Max	C Max	D Max	E	F Max	L Max		J	M Max
			solder	crimp							solder	crimp		
		08	36.70 1.445	36.00 1.417	12.03 .474	11.70 .461	1.32 .052	15.35 .604	15.09 .594	20.99 .826	7.20 .283	6.70 .264	3.13 .123	3.70 .146
		10	36.70 1.445	36.00 1.417	15.01 .591	11.70 .461	1.32 .052	18.15 .715	18.26 .719	24.19 .952	10.20 .402	9.40 .370	3.13 .123	3.70 .146
		12	36.70 1.445	36.00 1.417	19.07 .751	11.70 .461	1.32 .052	23.45 .923	20.62 .812	26.54 1.045	13.20 .520	11.95 .470	3.13 .123	3.70 .146
		14	36.70 1.445	36.00 1.417	22.25 .876	11.70 .461	1.32 .052	24.25 .955	23.00 .906	28.89 1.137	16.10 .634	15.15 .596	3.13 .123	3.70 .146
		16	39.00 1.535	38.30 1.508	28.60 1.001	11.70 .461	1.32 .052	31.75 1.163	26.97 .969	33.69 1.232	21.30 .758	19.95 .711	3.13 .123	3.70 .146
		18	39.00 1.535	38.30 1.508	28.60 1.126	11.70 .461	1.32 .052	31.75 1.250	26.97 1.062	33.69 1.326	21.30 .839	19.95 .785	3.13 .123	3.70 .146
		20	45.30 1.783	44.20 1.740	31.77 1.251	14.35 .565	2.15 .085	35.85 1.411	29.36 1.156	36.89 1.452	24.40 .961	23.05 .907	3.13 .123	3.70 .146
		22	45.30 1.783	44.20 1.740	34.95 1.376	14.35 .565	2.15 .085	38.20 1.504	31.75 1.250	39.99 1.574	27.50 1.083	25.55 1.006	3.13 .123	3.70 .146
		24	44.00 1.732	42.60 1.677	38.12 1.501	15.20 .598	2.15 .085	41.30 1.626	34.92 1.375	43.15 1.699	30.60 1.205	28.65 1.128	3.81 .150	3.70 .146

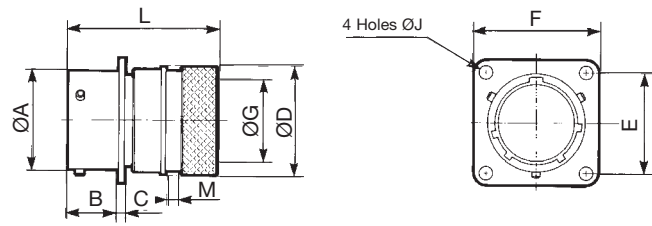

Square flange receptacle with removable straight backshell for heatshrink sleeving

solder 00 M	crimp 00 RM	shell size	L Max		A	B Max	C Max	D Max	E	F Max	G Max	J	M Max
			solder	crimp									
		08	50.00 1.969	12.03 .474	11.70 .461	1.32 .052	13.55 .604	15.09 .719	20.99 .952	7.05 .390	3.13 .123	3.50 .138	
		10	50.00 1.969	15.01 .591	11.70 .461	1.32 .052	15.35 .767	18.26 .812	24.19 1.045	9.90 .496	3.13 .123	3.50 .138	
		12	50.00 1.969	19.07 .751	11.70 .461	1.32 .052	19.48 .767	20.62 .812	26.54 1.045	12.60 .496	3.13 .123	3.50 .138	
		14	50.00 1.969	22.25 .876	11.70 .461	1.32 .052	21.30 .839	23.00 .906	28.89 1.137	15.90 .626	3.13 .123	3.50 .138	
		16	50.00 1.969	25.42 1.001	11.70 .461	1.32 .052	24.50 .965	24.61 .969	31.29 1.232	18.95 .746	3.13 .123	3.50 .138	
		18	50.00 1.969	28.60 1.126	11.70 .461	1.32 .052	26.45 1.041	26.97 1.062	33.69 1.326	20.90 .823	3.13 .123	3.50 .138	
		20	53.30 2.098	31.70 1.376	14.35 .565	2.15 .085	34.24 1.348	31.75 1.250	39.99 1.574	26.60 1.047	3.13 .123	3.50 .138	
		22	53.30 2.098	34.95 1.376	14.35 .565	2.15 .085	34.24 1.348	31.75 1.250	39.99 1.574	26.60 1.047	3.13 .123	3.50 .138	
		24	53.30 2.098	38.12 1.501	15.20 .598	2.15 .085	36.47 1.436	34.92 1.375	43.15 1.699	29.30 1.154	3.81 .150	3.50 .138	

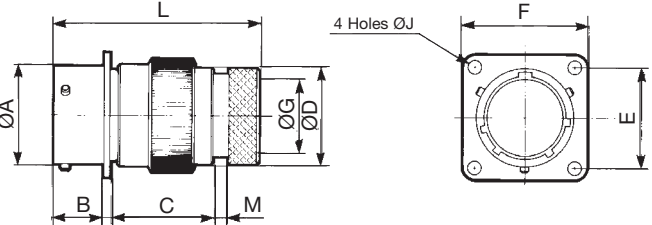

Square flange receptacle with removable straight backshell for screen termination and heatshrink sleeving (38 and 42 suffix)

solder 00 T	crimp 00 RT	shell size	L Max		A	B Max	C Max	D Max	E	F Max	G Max	J	M Max
			solder	crimp									
		08	51.60 2.031	12.03 .474	11.70 .461	1.32 .052	18.25 .719	15.09 .594	20.99 .826	7.45 .293	3.13 .123	3.70 .146	
		10	51.60 2.031	15.01 .591	11.70 .461	1.32 .052	20.25 .797	18.26 .719	24.19 .952	9.00 .354	3.13 .123	3.70 .146	
		12	51.60 2.031	22.25 .751	11.70 .461	1.32 .052	24.75 .974	20.62 .812	26.54 1.045	13.30 .524	3.13 .123	3.70 .146	
		14	51.60 2.031	22.25 .876	11.70 .461	1.32 .052	27.75 1.093	23.00 .906	28.89 1.137	16.50 .650	3.13 .123	3.70 .146	
		16	51.60 2.031	25.42 1.001	11.70 .461	1.32 .052	30.05 1.183	24.61 .969	31.29 1.232	18.50 .728	3.13 .123	3.70 .146	
		18	52.00 2.047	28.60 1.126	11.70 .461	1.32 .052	34.15 1.344	26.97 1.062	33.69 1.326	21.90 .862	3.13 .123	3.70 .146	
		20	55.10 2.169	31.77 1.251	14.35 .565	2.15 .085	37.25 1.467	29.36 1.156	36.89 1.452	25.10 .988	3.13 .123	3.70 .146	
		22	55.10 2.169	34.95 1.376	14.35 .565	2.15 .085	40.45 1.593	31.75 1.250	39.99 1.574	28.20 1.110	3.13 .123	3.70 .146	
		24	55.10 2.169	38.12 1.501	15.20 .598	2.15 .085	36.47 1.719	34.92 1.375	43.15 1.699	29.30 1.236	3.81 .150	3.50 .146	

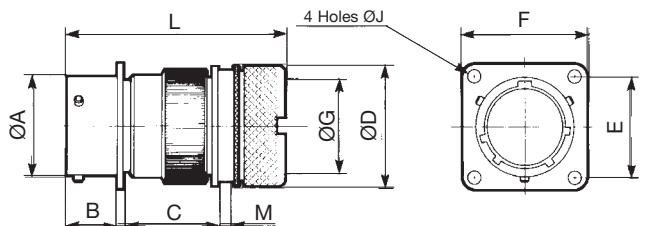

851 Series



Square flange receptacle with removable straight backshell for screen termination and heatshrink sleeving

solder 00 G	crimp 00 RG	VG 95328 R	shell size	L Max	A	B	C	D	E	F	G	J	M
				solder crimp	Max	Max	Max	Max	Max	Max	Max	Max	Max
			08	51.60 2.031	12.03 .474	11.70 .461	1.32 .052	18.25 .719	15.09 .594	20.99 .826	7.45 .293	3.13 .123	3.70 .146
			10	51.60 2.031	15.01 .591	11.70 .461	1.32 .052	20.25 .797	18.26 .719	24.19 .952	9.00 .354	3.13 .123	3.70 .146
			12	51.60 2.031	19.07 .751	11.70 .461	1.32 .052	24.75 .974	20.62 .812	26.54 1.045	13.30 .524	3.13 .123	3.70 .146
			14	51.60 2.031	22.25 .876	11.70 .461	1.32 .052	27.75 1.093	23.00 .906	28.89 1.137	16.50 .650	3.13 .123	3.70 .146
			16	51.60 2.031	25.42 1.001	11.70 .461	1.32 .052	30.05 1.183	24.61 .969	31.29 1.232	18.50 .728	3.13 .123	3.70 .146
			18	52.00 2.047	28.60 1.126	11.70 .461	1.32 .052	34.15 1.344	26.97 1.062	33.69 1.326	21.90 .862	3.13 .123	3.70 .146
			20	55.10 2.169	31.77 1.251	14.35 .565	2.15 .085	37.25 1.467	29.36 1.156	36.89 1.452	25.10 .988	3.13 .123	3.70 .146
			22	55.10 2.169	34.95 1.376	14.35 .565	2.15 .085	40.45 1.593	31.75 1.250	39.99 1.574	28.20 1.110	3.13 .123	3.70 .146
			24	55.10 2.169	38.12 1.501	15.20 .598	2.15 .085	43.65 1.719	34.92 1.375	43.15 1.699	31.40 1.236	3.81 .150	3.70 .146

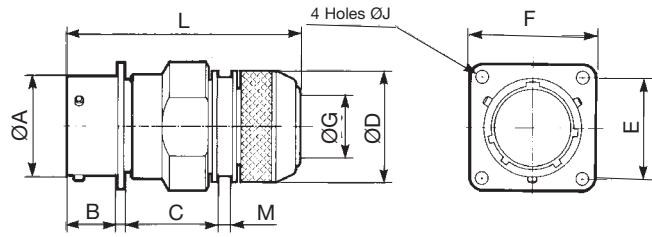

Square flange receptacle with straight sealing gland backshell

solder 00 J	HE 301 B 00 J	shell size	L Max	A	B	C	D	E	F	G		J
			solder	Max	Max	Max	Max	Max	Max	min	Max	Max
		08	47.60 1.874	12.03 .474	11.70 .461	1.32 .052	14.40 .567	15.09 .594	20.99 .826	5.02 .198	5.84 .230	3.13 .123
		10	47.60 1.874	15.01 .591	11.70 .461	1.32 .052	17.60 .693	18.26 .719	24.19 .952	5.94 .234	6.76 .266	3.13 .123
		12	48.70 1.917	19.07 .751	11.70 .461	1.32 .052	21.10 .831	20.62 .812	26.54 1.045	9.34 .368	10.16 .400	3.13 .123
		14	53.50 2.106	22.25 .876	11.70 .461	1.32 .052	24.40 .961	23.00 .906	28.89 1.137	11.32 .446	12.14 .478	3.13 .123
		16	59.00 2.323	25.42 1.001	11.70 .461	1.32 .052	27.60 1.087	24.61 .969	31.29 1.232	14.73 .580	15.55 .612	3.13 .123
		18	65.00 2.559	28.60 1.126	11.70 .461	1.32 .052	30.80 1.213	26.97 1.062	33.69 1.326	16.00 .630	16.82 .662	3.13 .123
		20	79.10 3.114	31.77 1.251	14.35 .565	2.15 .085	34.10 1.343	29.36 1.156	36.89 1.452	16.89 .665	17.70 .697	3.13 .123
		22	80.00 3.150	34.95 1.376	14.35 .565	2.15 .085	37.30 1.469	31.75 1.250	39.99 1.574	17.78 .700	18.60 .732	3.13 .123
		24	90.00 3.543	38.12 1.501	15.20 .598	2.15 .085	40.50 1.594	34.92 1.375	43.15 1.699	20.34 .801	21.16 .833	3.81 .150

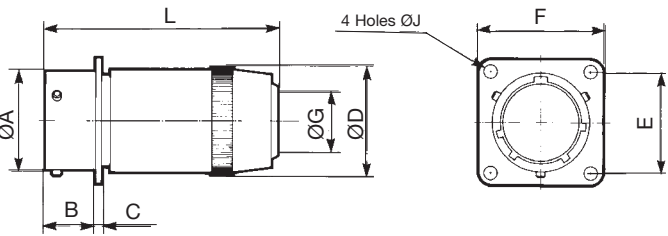

Square flange receptacle with straight sealing gland and cable clamp

solder 00 JC	MS 3110J	shell size	L Max	A	B	C	D	E	F	G		J
			solder	Max	Max	Max	Max	Max	Max	min	Max	Max
		08	57.68 2.271	12.03 .474	11.70 .461	1.32 .052	19.90 .783	15.09 .594	20.99 .826	5.02 .198	5.84 .230	3.13 .123
		10	57.68 2.271	15.01 .591	11.70 .461	1.32 .052	21.50 .846	18.26 .719	24.19 .952	5.94 .234	6.76 .266	3.13 .123
		12	61.24 2.411	19.07 .751	11.70 .461	1.32 .052	25.00 .984	20.62 .812	26.54 1.045	9.34 .368	10.16 .400	3.13 .123
		14	66.01 2.599	22.25 .876	11.70 .461	1.32 .052	27.80 1.094	23.00 .906	28.89 1.137	11.32 .446	12.14 .478	3.13 .123
		16	74.75 2.943	25.42 1.001	11.70 .461	1.32 .052	29.40 1.157	24.61 .969	31.29 1.232	14.73 .580	15.55 .612	3.13 .123
		18	80.57 3.172	28.60 1.126	11.70 .461	1.32 .052	35.30 1.390	26.97 1.062	33.69 1.326	16.00 .630	16.82 .662	3.13 .123
		20	91.69 3.610	31.77 1.251	14.35 .565	2.15 .085	35.30 1.390	29.36 1.156	36.89 1.452	16.89 .665	17.70 .697	3.13 .123
		22	95.66 3.766	34.95 1.376	14.35 .565	2.15 .085	41.10 1.618	31.75 1.250	39.99 1.574	17.78 .700	18.60 .732	3.13 .123
		24	101.22 3.985	38.12 1.501	15.20 .598	2.15 .085	42.40 1.669	34.92 1.375	43.15 1.699	20.34 .801	21.16 .833	3.81 .150

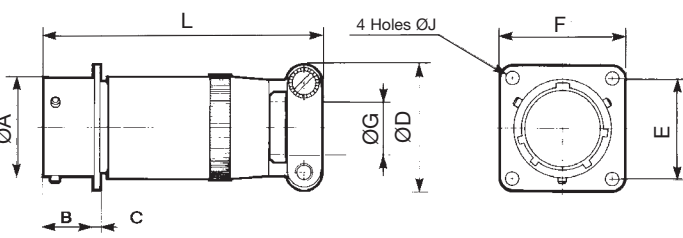

851 Series



Jam nut receptacle with backnut

solder 07 E	HE 301 B 07 E MS 3114 E	shell size	L Max		A	B Max	C Max	D Max	F Max	P Max	S Max
			solder	crimp							
crimp 07 R	HE 301 B 07 R MS 3124 E VG 95328 D	08	34.10 1.343	33.50 1.319	12.03 .474	17.90 .705	2.64 .104	18.50 .728	26.94 1.061	19.29 .759	23.94 .943
		10	34.10 1.343	33.50 1.319	15.01 .591	17.90 .705	2.64 .104	21.70 .854	30.14 1.187	22.38 .881	26.94 1.061
08	10	12	34.10 1.343	33.50 1.319	19.07 .751	17.90 .705	2.64 .104	24.90 .980	34.94 1.376	27.13 1.068	31.74 1.250
		14	34.10 1.343	33.50 1.319	22.25 .876	17.90 .705	2.64 .104	28.10 1.106	38.04 1.498	30.33 1.194	34.94 1.376
16	18	16	34.10 1.343	33.50 1.319	25.42 1.001	17.90 .705	2.64 .104	31.20 1.228	41.24 1.624	33.48 1.318	38.24 1.506
		18	34.10 1.343	33.50 1.319	28.60 1.126	17.90 .705	2.64 .104	34.40 1.354	44.44 1.750	36.68 1.444	41.34 1.628
20	22	20	39.30 1.547	37.90 1.492	31.77 1.251	22.45 .884	3.44 .135	38.30 1.508	49.14 1.935	39.83 1.568	46.04 1.813
		22	39.30 1.547	37.90 1.492	34.95 1.376	22.45 .884	3.44 .135	41.50 1.634	52.24 2.057	43.03 1.694	49.24 1.939
24	24	24	39.30 1.547	37.90 1.492	38.12 1.501	23.30 .917	3.44 .135	44.70 1.760	55.54 2.187	46.18 1.818	52.74 2.076

Jam nut receptacle with straight cable clamp

solder 07 EC	HE 301 B 07 EC MS 3114 F	shell size	L Max		A	B Max	C Max	D Max	F Max	G	P Max	S Max
			solder	crimp								
07 AC	HE 301 B 07 AC	08	49.31 1.941	49.10 1.933	12.03 .474	17.90 .705	2.64 .104	19.90 .783	26.94 1.061	3.50 .138	19.29 .759	23.94 .943
		10	49.31 1.941	49.10 1.933	15.01 .591	17.90 .705	2.64 .104	21.50 .846	30.14 1.187	5.00 .197	22.38 .881	26.94 1.061
crimp 07 RC	HE 301 B 07 RC MS 3124 F VG 95328 E	12	49.17 1.936	49.10 1.933	19.07 .751	17.90 .705	2.64 .104	25.00 .984	34.94 1.376	8.20 .323	27.13 1.068	31.74 1.250
		14	49.17 1.936	49.10 1.933	22.25 .876	17.90 .705	2.64 .104	27.80 1.094	38.04 1.498	10.00 .394	30.33 1.194	34.94 1.376
16	18	16	52.34 2.061	52.20 2.055	25.42 1.001	17.90 .705	2.64 .104	29.40 1.157	41.24 1.624	13.00 .512	33.48 1.318	38.24 1.506
		18	53.22 2.095	53.10 2.091	28.60 1.126	17.90 .705	2.64 .104	35.30 1.390	44.44 1.750	16.00 .630	36.68 1.444	41.34 1.628
20	22	20	58.10 2.287	58.00 2.283	31.77 1.251	22.45 .884	3.44 .135	35.30 1.390	49.14 1.935	16.00 .630	39.83 1.568	46.04 1.813
		22	58.10 2.287	58.00 2.283	34.95 1.376	22.45 .884	3.44 .135	41.10 1.618	52.24 2.057	19.30 .760	43.03 1.694	49.24 1.939
24	24	24	58.10 2.287	58.00 2.283	38.12 1.501	23.30 .917	3.44 .135	42.40 1.669	55.54 2.187	20.60 .811	46.18 1.818	52.74 2.076

Jam nut receptacle with straight backshell for potting

solder 07 P	HE 301 B 07 P MS 3114 P	shell size	L Max		A	B Max	C Max	D Max	F Max	G Max	P Max	S Max
			solder	crimp								
crimp 07 RP	HE 301 B 07 RP MS 3124 P	08	34.30 1.350	39.80 1.567	12.03 .474	17.90 .705	2.64 .104	15.34 .604	26.94 1.061	10.46 .412	19.29 .759	23.94 .943
		10	34.30 1.350	39.80 1.567	15.01 .591	17.90 .705	2.64 .104	17.70 .697	30.14 1.187	13.55 .533	22.38 .881	26.94 1.061
12	14	12	34.30 1.350	39.80 1.567	19.07 .751	17.90 .705	2.64 .104	21.69 .854	34.94 1.376	13.96 .550	27.13 1.068	31.74 1.250
		14	34.30 1.350	39.80 1.567	22.25 .876	17.90 .705	2.64 .104	23.90 .941	38.04 1.498	17.42 .686	30.33 1.194	34.94 1.376
16	18	16	34.30 1.350	39.80 1.567	25.42 1.001	17.90 .705	2.64 .104	27.00 1.063	41.24 1.624	20.56 .809	33.48 1.318	38.24 1.506
		18	34.10 1.343	41.80 1.646	28.60 1.126	17.90 .705	2.64 .104	30.50 1.201	44.44 1.750	23.66 .931	36.68 1.444	41.34 1.628
20	22	20	42.25 1.663	49.92 1.965	31.77 1.251	22.45 .884	3.44 .135	33.65 1.325	49.14 1.935	23.92 .942	39.83 1.568	46.04 1.813
		22	42.25 1.663	49.92 1.965	34.95 1.376	22.45 .884	3.44 .135	37.10 1.461	52.24 2.057	25.52 1.005	43.03 1.694	49.24 1.939
24	24	24	43.26 1.703	51.30 2.020	38.12 1.501	23.30 .917	3.44 .135	40.00 1.575	55.54 2.187	32.00 1.260	46.18 1.818	52.74 2.076



851 Series

Jam nut receptacle with straight backshell for heatshrink sleeving

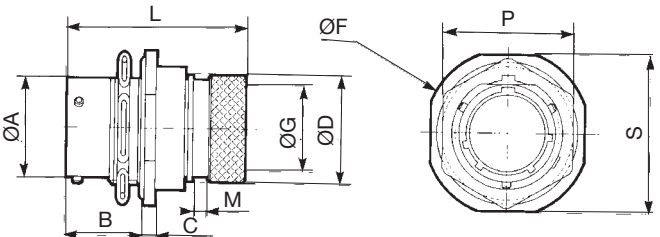
solder			VG	95328 S		shell size	L Max		A	B Max	C Max	D Max	F Max	G Max		M Max	P Max	S Max
crimp		solder					crimp	solder						crimp				
07 T						08	42.60 1.677	41.50 1.634	12.03 .474	17.90 .705	2.64 .104	15.35 .604	26.94 1.061	7.20 .283	6.70 .264	3.70 .146	19.29 .759	23.94 .943
07 RT						10	42.60 1.677	41.50 1.634	15.01 .591	17.90 .705	2.64 .104	18.15 .715	30.14 1.187	10.20 .402	9.40 .370	3.70 .146	22.38 .881	26.94 1.061
						12	42.60 1.677	41.50 1.634	19.07 .751	17.90 .705	2.64 .104	23.45 .923	34.94 1.376	13.20 .520	11.95 .470	3.70 .146	27.13 1.068	31.74 1.250
						14	42.60 1.677	41.50 1.634	22.25 .876	17.90 .705	2.64 .104	24.25 .955	38.04 1.498	16.10 .634	15.15 .596	3.70 .146	30.33 1.194	34.94 1.376
						16	44.40 1.748	43.80 1.724	25.42 1.001	17.90 .705	2.64 .104	29.55 1.163	41.24 1.624	19.25 .758	18.05 .711	3.70 .146	33.48 1.318	38.24 1.506
						18	44.40 1.748	43.80 1.724	28.60 1.126	17.90 .705	2.64 .104	31.75 1.250	44.44 1.750	21.30 .839	19.95 .785	3.70 .146	36.68 1.444	41.24 1.624
						20	50.90 2.004	49.80 1.961	31.77 1.251	22.45 .884	3.44 .135	35.85 1.411	49.14 1.935	24.40 .961	23.05 .907	3.70 .146	39.83 1.568	46.04 1.813
						22	50.90 2.004	49.80 1.961	34.95 1.376	22.45 .884	3.44 .135	38.20 1.504	52.24 2.057	27.50 1.083	25.55 1.006	3.70 .146	43.03 1.694	49.24 1.939
						24	49.60 1.953	48.50 1.909	38.12 1.501	23.30 .917	3.44 .135	41.30 1.626	55.54 2.187	30.60 1.205	28.65 1.128	3.70 .146	46.18 1.818	52.74 2.076

Jam nut receptacle with removable straight backshell for screen termination and heatshrink sleeving (38 and 42 suffix)

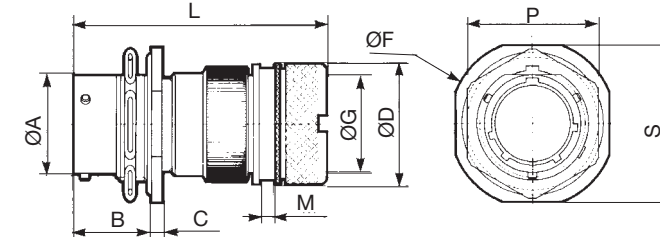
solder						shell size	L Max		A	B Max	C Max	D Max	F Max	G Max	M Max	P Max	S Max
crimp		solder					crimp										
07 T						08	60.00 2.362	12.03 .474	17.90 .705	2.64 .104	18.25 .719	26.94 1.061	7.45 .293	3.70 .146	19.29 .759	23.94 .943	
07 RT						10	60.00 2.362	15.01 .591	17.90 .705	2.64 .104	20.25 .797	30.14 1.187	9.00 .354	3.70 .146	22.38 .881	26.94 1.061	
						12	60.00 2.362	19.07 .751	17.90 .705	2.64 .104	24.75 .974	34.94 1.376	13.30 .524	3.70 .146	27.13 1.068	31.74 1.250	
						14	60.00 2.362	22.25 .876	17.90 .705	2.64 .104	27.75 1.093	38.04 1.498	16.50 .650	3.70 .146	30.33 1.194	34.94 1.376	
						16	60.00 2.362	25.42 1.001	17.90 .705	2.64 .104	30.05 1.183	41.24 1.624	18.50 .728	3.70 .146	33.48 1.318	38.24 1.506	
						18	60.40 2.378	28.60 1.126	17.90 .705	2.64 .104	34.15 1.344	44.44 1.750	21.90 .862	3.70 .146	36.68 1.444	41.34 1.628	
						20	63.40 2.496	31.77 1.251	22.45 .884	3.44 .135	37.25 1.467	49.14 1.935	25.10 .988	3.70 .146	39.83 1.568	46.04 1.813	
						22	63.40 2.496	34.95 1.376	22.45 .884	3.44 .135	40.45 1.593	52.24 2.057	28.20 1.110	3.70 .146	43.03 1.694	49.24 1.939	
						24	63.40 2.496	38.12 1.501	23.30 .917	3.44 .135	43.65 1.719	55.54 2.187	31.40 1.236	3.70 .146	46.18 1.818	52.74 2.076	

Jam nut receptacle with removable straight backshell for screen termination and heatshrink sleeving

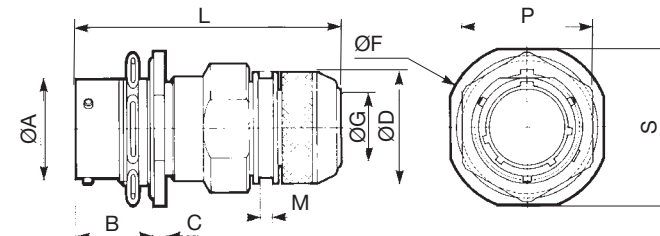
solder			VG	95328 T		shell size	L Max		A	B Max	C Max	D Max	F Max	G Max	M Max	P Max	S Max
crimp		solder					crimp										
07 G						08	62.20 2.449	12.03 .474	11.90 .469	2.64 .104	16.30 .642	26.94 1.061	7.45 .293	3.60 .142	19.29 .759	23.94 .943	
07 RG						10	62.20 2.449	15.01 .591	17.90 .705	2.64 .104	18.30 .720	30.14 1.187	10.30 .406	3.60 .142	22.38 .881	26.94 1.061	
						12	62.20 2.449	19.07 .751	17.90 .705	2.64 .104	22.30 .878	34.94 1.376	13.20 .520	3.60 .142	27.13 1.068	31.74 1.250	
						14	62.40 2.457	22.25 .876	17.90 .705	2.64 .104	25.30 .996	38.04 1.498	16.50 .650	3.60 .142	30.33 1.194	34.94 1.376	
						16	62.40 2.457	25.42 1.001	17.90 .705	2.64 .104	28.30 1.114	41.24 1.624	19.35 .762	3.60 .142	33.48 1.318	38.24 1.506	
						18	62.40 2.457	28.60 1.126	17.90 .705	2.64 .104	32.30 1.272	44.44 1.750	21.60 .850	3.60 .142	36.68 1.444	41.34 1.628	
						20	67.50 2.657	31.77 1.251	22.45 .884	3.44 .135	34.30 1.350	49.14 1.935	24.80 .976	3.60 .142	39.83 1.568	46.04 1.813	
						22	67.50 2.657	34.95 1.376	22.45 .884	3.44 .135	38.30 1.508	52.24 2.057	27.90 1.098	3.60 .142	43.03 1.694	49.24 1.939	
						24	67.50 2.657	38.12 1.501	23.30 .917	3.44 .135	41.30 1.626	55.54 2.187	31.00 1.220	3.60 .142	46.18 1.818	52.74 2.076	

851 Series



Square flange receptacle not accepting backshell

solder 02 E	HE 301 B 02 E MS 3112 E VG 95328 H	shell size	L Max		A	B Max	C Max	D Max	E	F Max	J
			solder	crimp							
crimp 02 R	HE 301 B 02 R MS 3122 E VG 95328 C	08	25.18 .991	32.35 1.274	12.03 .474	11.70 .461	1.32 .052	10.84 .427	15.09 .594	20.99 .826	3.13 .123
		10	25.10 .988	32.35 1.274	15.01 .591	11.70 .461	1.32 .052	13.99 .551	18.26 .719	24.19 .952	3.13 .123
		12	25.10 .988	32.35 1.274	19.07 .751	11.70 .461	1.32 .052	17.37 .684	20.62 .812	26.54 1.045	3.13 .123
		14	25.10 .988	32.35 1.274	22.25 .876	11.70 .461	1.32 .052	20.57 .810	23.00 .906	28.89 1.137	3.13 .123
		16	25.10 .988	32.35 1.274	25.42 1.001	11.70 .461	1.32 .052	23.72 .934	24.61 .969	31.29 1.232	3.13 .123
		18	25.10 .988	32.35 1.274	28.60 1.126	11.70 .461	1.32 .052	26.69 1.051	26.97 1.062	33.69 1.326	3.13 .123
		20	26.67 1.050	33.95 1.337	31.77 1.251	14.35 .565	2.15 .085	29.89 1.177	29.36 1.156	36.89 1.452	3.13 .123
		22	26.67 1.050	33.95 1.337	34.95 1.376	14.35 .565	2.15 .085	33.04 1.301	31.75 1.250	39.99 1.574	3.13 .123
		24	26.67 1.050	33.95 1.337	38.12 1.501	15.20 .598	2.15 .085	36.24 1.427	34.92 1.375	43.15 1.699	3.81 .150

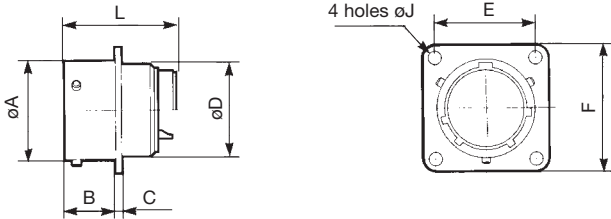

Jam nut receptacle not accepting backshell

solder 07 A	HE 301 B 07 A	shell size	L Max		A	B Max	C Max	F Max	P Max	S Max
			solder							
		08	25.18 .991		12.03 .474	17.90 .705	2.64 .104	26.94 1.061	19.29 .759	23.94 .943
		10	25.10 .988		15.01 .591	17.90 .705	2.64 .104	30.14 1.187	22.38 .881	26.94 1.061
		12	25.10 .988		19.07 .751	17.90 .705	2.64 .104	34.94 1.376	27.13 1.068	31.74 1.250
		14	25.10 .988		22.25 .876	17.90 .705	2.64 .104	38.04 1.498	30.33 1.194	34.94 1.376
		16	25.10 .988		25.42 1.001	17.90 .705	2.64 .104	41.24 1.624	33.48 1.318	38.24 1.506
		18	25.10 .988		28.60 1.126	17.90 .705	2.64 .104	44.44 1.750	36.68 1.444	41.34 1.628
		20	26.67 1.050		31.77 1.251	22.45 .884	3.44 .135	49.14 1.935	39.83 1.568	46.04 1.813
		22	26.67 1.050		34.95 1.376	22.45 .884	3.44 .135	52.24 2.057	43.03 1.694	49.24 1.939
		24	26.67 1.050		38.12 1.501	23.30 .917	3.44 .135	55.54 2.187	46.18 1.818	52.74 2.076

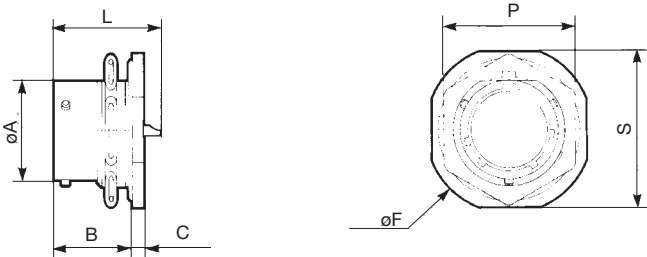

Cable connecting receptacle with backnut

solder 01 E	HE 301 B 01 E MS 3111 E	shell size	L Max		A	B Max	C Max	D Max	F Max	P Max
			solder	crimp						
crimp 01 R	HE 301 B 01 R MS 3121 E	08	32.70 1.287	32.00 1.260	12.03 .474	10.60 .417	2.10 .083	13.50 .531	24.24 .954	20.99 .826
		10	32.70 1.287	32.00 1.260	15.01 .591	10.60 .417	2.10 .083	16.70 .657	27.44 1.080	24.19 .952
		12	32.70 1.287	32.00 1.260	19.07 .751	10.60 .417	2.10 .083	19.90 .783	29.79 1.173	26.54 1.045
		14	32.70 1.287	32.00 1.260	22.25 .876	10.60 .417	2.10 .083	23.40 .921	32.10 1.264	28.89 1.137
		16	32.70 1.287	32.00 1.260	25.42 1.001	10.60 .417	2.10 .083	26.60 1.047	34.59 1.362	31.29 1.232
		18	32.70 1.287	32.00 1.260	28.60 1.126	10.60 .417	2.10 .083	29.50 1.161	36.94 1.454	33.69 1.326
		20	34.50 1.358	33.40 1.315	31.77 1.251	13.85 .545	2.65 .104	32.70 1.287	40.14 1.580	36.89 1.452
		22	34.50 1.358	33.40 1.315	34.95 1.376	13.85 .545	2.65 .104	36.00 1.417	43.24 1.702	40.00 1.575
		24	34.50 1.358	33.40 1.315	38.12 1.501	14.70 .579	2.65 .104	39.10 1.539	46.44 1.828	43.29 1.704

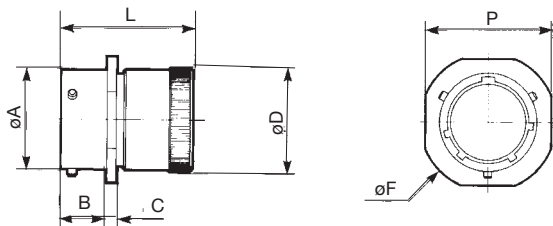

851 Series



Cable connecting receptacle with straight cable clamp

solder 01 EC	HE 301 B 01 EC MS 3111 F	shell size	L Max		A	B Max	C Max	D Max	F Max	G Max	P Max
			solder	crimp							
01 AC	HE 301 B 01 AC	08	48.00 1.890	47.30 1.862	12.03 .474	10.60 .417	2.10 .083	19.90 .783	24.24 .954	3.50 .138	20.99 .826
01 RC	HE 301 B 01 RC MS 3121 F		10	48.00 1.890	47.30 1.862	15.01 .591	10.60 .417	2.10 .083	21.50 .846	27.44 1.080	5.00 .197
		12		48.00 1.890	47.30 1.862	19.07 .751	10.60 .417	2.10 .083	25.00 .984	29.79 1.173	8.20 .323
		14	48.00 1.890	47.30 1.862	22.25 .876	10.60 .417	2.10 .083	27.80 1.094	32.10 1.264	10.00 .394	28.89 1.137
		16	51.00 2.008	50.50 1.988	25.42 1.001	10.60 .417	2.10 .083	29.40 1.157	34.59 1.362	13.00 .512	31.29 1.232
		18	51.00 2.008	50.50 1.988	28.60 1.126	10.60 .417	2.10 .083	35.30 1.390	36.94 1.454	16.00 .630	33.69 1.326
		20	53.00 2.087	51.50 2.028	31.77 1.251	13.85 .545	2.65 .104	35.30 1.390	40.14 1.580	16.00 .630	36.89 1.452
		22	53.00 2.087	51.50 2.028	34.95 1.376	13.85 .545	2.65 .104	41.10 1.618	43.24 1.702	19.30 .760	40.00 1.575
		24	53.00 2.087	51.50 2.028	38.12 1.501	14.70 .579	2.65 .104	42.40 1.669	46.44 1.828	20.60 .811	43.29 1.704

Cable connecting receptacle with straight backshell for potting

solder 01 P	HE 301 B 01 P MS 3111 P	shell size	L Max		A	B Max	C Max	D Max	F Max	G Max	P Max
			solder	crimp							
01 RP	HE 301 B 01 RP MS 3121 P	08	36.20 1.425	41.70 1.642	12.03 .474	10.60 .417	2.10 .083	15.34 .604	24.24 .954	10.46 .412	20.99 .826
			10	36.20 1.425	41.70 1.642	15.01 .591	10.60 .417	2.10 .083	17.70 .697	27.44 1.080	13.55 .533
		12	36.20 1.425	41.70 1.642	19.07 .751	10.60 .417	2.10 .083	21.69 .854	29.79 1.173	13.96 .550	26.54 1.045
		14	36.20 1.425	41.70 1.642	22.25 .876	10.60 .417	2.10 .083	23.90 .941	32.10 1.264	17.42 .686	28.89 1.137
		16	36.20 1.425	41.70 1.642	25.42 1.001	10.60 .417	2.10 .083	27.00 1.063	34.59 1.362	20.56 .809	31.29 1.232
		18	36.91 1.453	44.46 1.750	28.60 1.126	10.60 .417	2.10 .083	30.50 1.201	36.94 1.454	23.66 .931	33.69 1.326
		20	43.80 1.724	50.93 2.005	31.77 1.251	13.85 .545	2.65 .104	33.65 1.325	40.15 1.581	23.92 .942	36.89 1.452
		22	43.80 1.724	50.93 2.005	34.95 1.376	13.85 .545	2.65 .104	37.10 1.461	42.24 1.663	25.52 1.005	40.00 1.575
		24	43.80 1.724	50.93 2.005	38.12 1.501	14.70 .579	2.65 .104	40.00 1.575	46.44 1.828	32.00 1.260	43.29 1.704

Cable connecting receptacle with straight adapter

solder 01 A	HE 301 B 01 A	shell size	L Max solder crimp	A	B Max	C Max	D Max	F Max	G Max	K Threading UNEF 2 A	P Max
		08	41.00 1.614	12.03 .474	10.60 .417	2.10 .083	14.50 .571	24.24 .954	9.10 .358	1/2 28	20.99 .826
		10	41.00 1.614	15.01 .591	10.60 .417	2.10 .083	18.70 .736	27.44 1.080	12.08 .476	5/8 24	24.19 .952
		12	41.00 1.614	19.07 .751	10.60 .417	2.10 .083	21.70 .854	29.79 1.173	15.25 .600	3/4 20	26.54 1.045
		14	41.00 1.614	22.25 .876	10.60 .417	2.10 .083	25.10 .988	32.10 1.264	18.15 .715	7/8 20	28.89 1.137
		16	41.00 1.614	25.42 1.001	10.60 .417	2.10 .083	28.13 1.107	34.59 1.362	21.32 .839	1-20	31.29 1.232
		18	41.00 1.614	28.60 1.126	10.60 .417	2.10 .083	31.38 1.235	36.94 1.454	24.32 .957	1-3/16 18	33.69 1.326
		20	44.00 1.732	31.77 1.251	13.85 .545	2.65 .104	34.30 1.350	40.15 1.581	26.73 1.052	1-3/16 18	36.89 1.452
		22	44.00 1.732	34.95 1.376	13.85 .545	2.65 .104	37.60 1.480	42.24 1.663	30.67 1.207	1-7/16 18	40.00 1.575
		24	44.00 1.732	38.12 1.501	14.70 .579	2.65 .104	40.70 1.602	46.44 1.828	33.08 1.302	1-7/16 18	43.29 1.704

851 Series



Cable connecting receptacle with straight backshell for heatshrink sleeving

solder 01 T	crimp 01 RT	shell size	L Max		A	B Max	C Max	D Max	F Max	G Max		P Max	M Max
			solder	crimp						solder	crimp		
		08	36.70 1.445	36.00 1.417	12.03 .474	10.60 .417	2.10 .083	15.35 .604	24.24 .954	7.20 .283	6.70 .264	20.99 .826	3.70 .146
		10	36.70 1.445	36.00 1.417	15.01 .591	10.60 .417	2.10 .083	18.15 .715	27.44 1.080	10.20 .402	9.40 .370	24.19 .952	3.70 .146
		12	36.70 1.445	36.00 1.417	19.07 .751	10.60 .417	2.10 .083	23.45 .923	29.70 1.169	13.20 .520	11.95 .470	26.54 1.045	3.70 .146
		14	36.70 1.445	36.00 1.417	22.25 .876	10.60 .417	2.10 .083	24.25 .955	32.10 1.264	16.10 .634	15.15 .596	28.89 1.137	3.70 .146
		16	39.00 1.535	38.30 1.508	25.42 1.001	10.60 .417	2.10 .083	29.55 1.163	34.59 1.362	19.25 .758	18.05 .711	31.29 1.232	3.70 .146
		18	39.00 1.535	38.30 1.508	28.60 1.126	10.60 .417	2.10 .083	31.75 1.250	36.94 1.454	21.30 .839	19.95 .785	33.69 1.326	3.70 .146
		20	45.30 1.783	44.20 1.740	31.77 1.251	13.85 .545	2.65 .104	35.85 1.411	40.15 1.581	24.40 .961	23.05 .907	36.89 1.452	3.70 .146
		22	45.30 1.783	44.20 1.740	34.95 1.376	13.85 .545	2.65 .104	38.20 1.504	42.24 1.663	27.50 1.073	25.55 1.006	40.00 1.575	3.70 .146
		24	44.00 1.732	42.60 1.677	38.12 1.501	14.70 .579	2.65 .104	41.30 1.626	46.44 1.828	30.60 1.205	28.65 1.128	43.29 1.704	3.70 .146

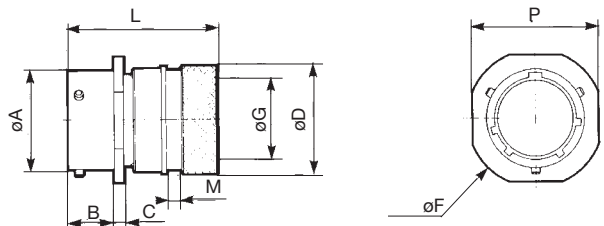

Cable connecting receptacle with removable straight backshell for heatshrink sleeving

solder 01 M	crimp 01 RM	shell size	L Max		A	B Max	C Max	D Max	F Max	G Max	P Max	M Max
			solder	crimp								
		08	50.00 1.969	50.00 1.969	12.03 .474	10.60 .417	2.10 .083	13.55 .533	24.24 .954	7.05 .278	20.99 .826	3.50 .138
		10	50.00 1.969	50.00 1.969	15.01 .591	10.60 .417	2.10 .083	15.35 .604	27.44 1.080	9.90 .390	24.19 .952	3.50 .138
		12	50.00 1.969	50.00 1.969	19.07 .751	10.60 .417	2.10 .083	19.48 .767	29.79 1.173	12.60 .496	26.54 1.045	3.50 .138
		14	50.00 1.969	50.00 1.969	22.25 .876	10.60 .417	2.10 .083	21.30 .839	32.10 1.264	15.90 .626	28.89 1.137	3.50 .138
		16	50.00 1.969	50.00 1.969	25.42 1.001	10.60 .417	2.10 .083	24.50 .965	34.59 1.362	18.95 .746	31.29 1.232	3.50 .138
		18	50.00 1.969	50.00 1.969	28.60 1.126	10.60 .417	2.10 .083	26.45 1.041	36.94 1.454	20.90 .823	33.69 1.326	3.50 .138
		20	53.30 2.098	53.30 2.098	31.77 1.251	13.85 .545	2.65 .104	30.75 1.211	40.15 1.581	23.70 .933	36.89 1.452	3.50 .138
		22	53.30 2.098	53.30 2.098	34.95 1.376	13.85 .545	2.65 .104	34.24 1.348	42.24 1.663	26.60 1.047	40.00 1.575	3.50 .138
		24	53.30 2.098	53.30 2.098	38.12 1.501	14.70 .579	2.65 .104	36.47 1.436	46.44 1.828	29.30 1.154	43.29 1.704	3.50 .138

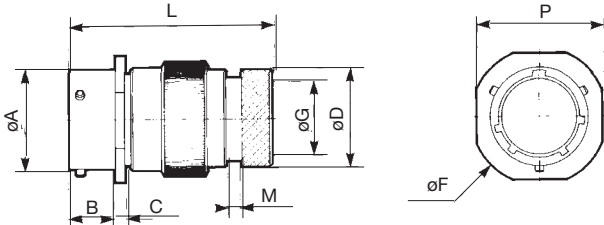

Cable connecting receptacle with removable straight backshell for screen termination and heatshrink sleeving (38 and 42 suffix)

solder 01 T	crimp 01 RT	shell size	L Max		A	B Max	C Max	D Max	F Max	G Max	M Max	P Max
			solder	crimp								
		08	51.60 2.031	51.60 2.031	12.03 .474	10.60 .417	2.10 .083	18.25 .719	24.24 .954	7.45 .293	3.70 .146	20.99 .826
		10	51.60 2.031	51.60 2.031	15.01 .591	10.60 .417	2.10 .083	20.25 .797	27.44 1.080	9.00 .354	3.70 .146	24.19 .952
		12	51.60 2.031	51.60 2.031	19.07 .751	10.60 .417	2.10 .083	24.75 .974	29.79 1.173	13.30 .524	3.70 .146	26.54 1.045
		14	51.60 2.031	51.60 2.031	22.25 .876	10.60 .417	2.10 .083	27.75 1.093	32.10 1.264	16.50 .650	3.70 .146	28.89 1.137
		16	51.60 2.031	51.60 2.031	25.42 1.001	10.60 .417	2.10 .083	30.05 1.183	34.59 1.362	18.50 .728	3.70 .146	31.29 1.232
		18	52.00 2.047	52.00 2.047	28.60 1.126	10.60 .417	2.10 .083	34.15 1.344	36.94 1.454	21.90 .862	3.70 .146	33.69 1.326
		20	55.10 2.169	55.10 2.169	31.77 1.251	13.85 .545	2.65 .104	37.25 1.467	40.15 1.581	25.10 .988	3.70 .146	36.89 1.452
		22	55.10 2.169	55.10 2.169	34.95 1.376	13.85 .545	2.65 .104	40.45 1.593	42.24 1.663	28.20 1.110	3.70 .146	40.00 1.575
		24	55.10 2.169	55.10 2.169	38.12 1.501	14.70 .579	2.65 .104	43.65 1.719	46.44 1.828	31.40 1.236	3.70 .146	43.29 1.704

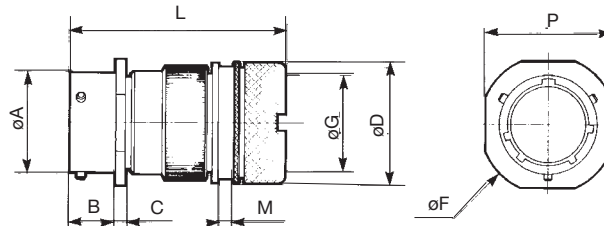

851 Series



Cable connecting receptacle with removable straight backshell for screen termination and heatshrink sleeving

solder 01 G	crimp 01 RG	shell size	L Max solder crimp	A	B Max	C Max	D Max	F Max	G Max	M Max	P Max
		08	54.00 2.126	12.03 .474	10.60 .417	2.10 .083	16.30 .642	24.24 .954	7.45 .293	3.60 .142	20.99 .826
		10	54.00 2.126	15.01 .591	10.60 .417	2.10 .083	18.30 .720	27.44 1.080	10.30 .406	3.60 .142	24.19 .952
		12	54.00 2.126	19.07 .751	10.60 .417	2.10 .083	22.30 .878	29.79 1.173	13.20 .520	3.60 .142	26.54 1.045
		14	54.00 2.126	22.25 .876	10.60 .417	2.10 .083	25.30 .996	32.10 1.264	16.50 .650	3.60 .142	28.89 1.137
		16	54.00 2.126	25.42 1.001	10.60 .417	2.10 .083	28.30 1.114	34.59 1.362	19.35 .762	3.60 .142	31.29 1.232
		18	54.00 2.126	28.60 1.126	10.60 .417	2.10 .083	32.30 1.272	36.94 1.454	21.60 .850	3.60 .142	33.69 1.326
		20	59.30 2.335	31.77 1.251	13.85 .545	2.65 .104	34.30 1.350	40.15 1.581	24.80 .976	3.60 .142	36.89 1.452
		22	59.30 2.335	34.95 1.376	13.85 .545	2.65 .104	38.30 1.508	42.24 1.663	27.90 1.098	3.60 .142	40.00 1.575
		24	59.30 2.335	38.12 1.501	14.70 .579	2.65 .104	41.30 1.626	46.44 1.828	31.00 1.220	3.60 .142	43.29 1.704

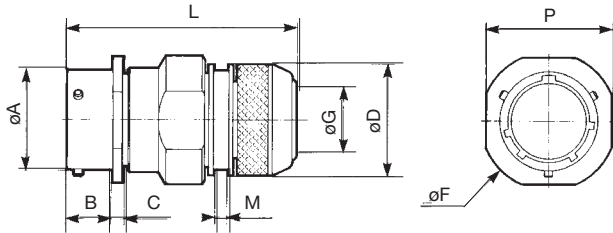

Cable connecting receptacle with straight sealing gland backshell

solder 01 J	HE 301 B 01 J	shell size	L Max solder	A	B Max	C Max	D Max	F Max	G		P Max
									min	Max	
		08	47.60 1.874	12.03 .474	10.60 .417	2.10 .083	14.40 .567	24.24 .954	5.02 .198	5.84 .230	20.99 .826
		10	47.60 1.874	15.01 .591	10.60 .417	2.10 .083	17.60 .693	27.44 1.080	5.94 .234	6.76 .266	24.19 .952
		12	48.70 1.917	19.07 .751	10.60 .417	2.10 .083	21.10 .831	29.79 1.173	9.34 .368	10.16 .400	26.54 1.045
		14	53.50 2.106	22.25 .876	10.60 .417	2.10 .083	24.40 .961	32.10 1.264	11.32 .446	12.14 .478	28.89 1.137
		16	59.00 2.323	25.42 1.001	10.60 .417	2.10 .083	27.60 1.087	34.59 1.362	14.73 .580	15.55 .612	31.29 1.232
		18	65.00 2.559	28.60 1.126	10.60 .417	2.10 .083	30.80 1.213	36.94 1.454	16.00 .630	16.82 .662	33.69 1.326
		20	79.10 3.114	31.77 1.251	13.85 .545	2.65 .104	34.10 1.343	40.15 1.581	16.89 .665	17.71 .697	36.89 1.452
		22	80.00 3.150	34.95 1.376	13.85 .545	2.65 .104	37.30 1.469	42.24 1.663	17.78 .700	18.60 .732	40.00 1.575
		24	90.00 3.543	38.12 1.501	14.70 .579	2.65 .104	40.50 1.594	46.44 1.828	20.34 .801	21.16 .833	43.29 1.704

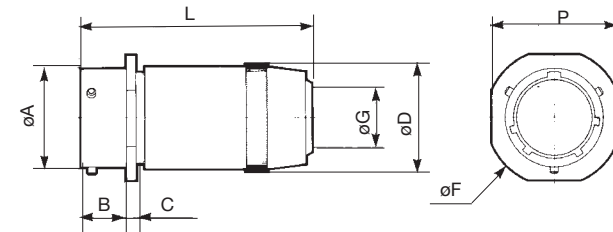

Cable connecting receptacle with straight sealing gland and cable clamp backshell

solder 01 JC	MS 3111 J	shell size	L Max solder	A	B Max	C Max	D Max	F Max	G		P Max
									min	Max	
		08	57.68 2.271	12.03 .474	10.60 .417	2.10 .083	19.90 .783	24.24 .954	5.02 .198	5.84 .230	20.99 .826
		10	57.68 2.271	15.01 .591	10.60 .417	2.10 .083	21.50 .846	27.44 1.080	5.94 .234	6.76 .266	24.19 .952
		12	61.24 2.411	19.07 .751	10.60 .417	2.10 .083	25.00 .984	29.79 1.173	9.34 .368	10.16 .400	26.54 1.045
		14	66.01 2.599	22.25 .876	10.60 .417	2.10 .083	27.80 1.094	32.10 1.264	11.32 .446	12.14 .478	28.89 1.137
		16	74.75 2.943	25.42 1.001	10.60 .417	2.10 .083	29.40 1.157	34.59 1.362	14.73 .580	15.50 .610	31.29 1.232
		18	80.57 3.172	28.60 1.126	10.60 .417	2.10 .083	35.30 1.390	36.94 1.454	16.00 .630	16.82 .662	33.69 1.326
		20	91.69 3.610	31.77 1.251	13.85 .545	2.65 .104	35.30 1.390	40.15 1.581	16.89 .665	17.71 .697	36.89 1.452
		22	95.66 3.766	34.95 1.376	13.85 .545	2.65 .104	41.10 1.618	42.24 1.663	17.78 .700	18.60 .732	40.00 1.575
		24	101.22 3.985	38.12 1.501	14.70 .579	2.65 .104	42.40 1.669	46.44 1.828	20.34 .801	21.16 .833	43.29 1.704

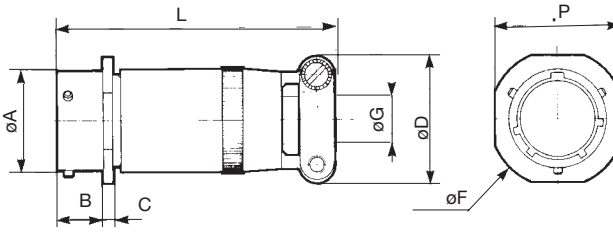



851 Series

Plug with backnut

solder 06 E	HE 301 B 06 E MS 3116 E	shell size	L Max		A Max	D Max
			solder	crimp		
crimp 06 R	HE 301 B 06 R MS 3126 E	08	32.54 1.281	32.00 1.260	19.05 .750	13.50 .531
		10	32.54 1.281	32.00 1.260	21.80 .858	16.70 .657
		12	32.54 1.281	32.00 1.260	26.15 1.030	19.90 .783
		14	32.54 1.281	32.00 1.260	29.35 1.156	23.40 .921
		16	32.54 1.281	32.00 1.260	32.50 1.280	26.60 1.047
		18	32.54 1.281	32.00 1.260	35.30 1.390	29.60 1.165
		20	33.30 1.311	32.10 1.264	38.85 1.530	32.70 1.287
		22	33.30 1.311	32.10 1.264	42.05 1.656	36.00 1.417
		24	33.30 1.311	32.10 1.264	45.10 1.776	39.10 1.539

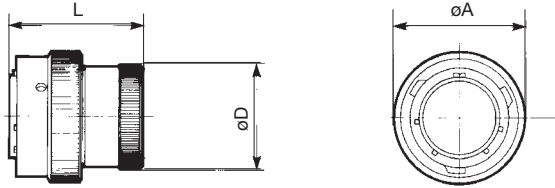

Plug with straight cable clamp

solder 06 EC	HE 301 B 06 EC MS 3116 F	shell size	L Max		A Max	D Max	G
			solder	crimp			
06 AC	HE 301 B 06 AC	08	48.00 1.890	47.30 1.862	19.05 .750	19.90 .783	3.50 .138
		10	48.00 1.890	47.30 1.862	21.80 .858	21.50 .846	5.00 .197
crimp 06 RC	HE 301 B 06 RC MS 3126 F VG 95328 K	12	48.00 1.890	47.30 1.862	26.15 1.030	25.00 .984	8.20 .323
		14	48.00 1.890	47.30 1.862	29.35 1.156	27.80 1.094	10.00 .394
		16	51.00 2.008	50.50 1.988	32.50 1.280	29.40 1.157	13.00 .512
		18	51.00 2.008	50.50 1.988	35.30 1.390	35.30 1.390	16.00 .630
		20	52.00 2.047	50.20 1.976	38.85 1.530	35.30 1.390	16.00 .630
		22	52.00 2.047	50.20 1.976	42.05 1.656	41.10 1.618	19.30 .760
		24	52.00 2.047	50.20 1.976	45.10 1.776	42.40 1.669	20.60 .811

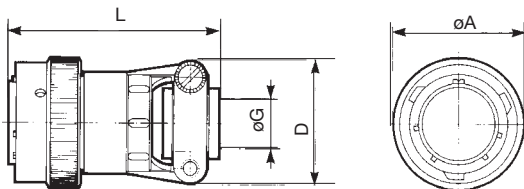

Plug with straight backshell for potting

solder 06 P	HE 301 B 06 P MS 3116 P	shell size	L Max		A Max	D Max	G Max
			solder	crimp			
crimp 06 RP	HE 301 B 06 RP MS 3126 P	08	36.20 1.425	42.10 1.657	19.05 .750	15.34 .604	10.46 .412
		10	36.20 1.425	42.10 1.657	21.80 .858	17.70 .697	13.55 .533
		12	36.20 1.425	42.10 1.657	26.15 1.030	21.69 .854	13.96 .550
		14	36.20 1.425	42.10 1.657	29.35 1.156	23.90 .941	17.42 .686
		16	36.20 1.425	42.10 1.657	32.50 1.280	27.00 1.063	20.56 .809
		18	37.70 1.484	45.40 1.787	35.30 1.390	30.50 1.201	23.66 .931
		20	42.40 1.669	50.00 1.969	38.85 1.530	33.65 1.325	23.92 .942
		22	42.40 1.669	50.00 1.969	42.05 1.656	37.10 1.461	25.52 1.005
		24	42.85 1.687	50.00 1.969	45.10 1.776	40.00 1.575	32.00 1.260

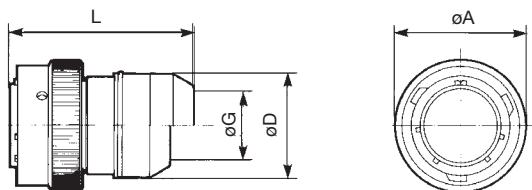

851 Series

Plug with straight adapter

solder 06 A	HE 301 B 06 A	shell size	L Max		A Max	D Max	G Max	K Threading UNEF 2 A
			solder	crimp				
crimp 06 RA	HE 301 B 06 RA	08	41.00 1.614	41.00 1.614	19.05 .750	14.50 .571	9.10 .358	1/2 28
		10	41.00 1.614	41.00 1.614	21.80 .858	18.70 .736	12.08 .476	5/8 24
		12	41.00 1.614	41.00 1.614	26.15 1.030	21.70 .854	15.25 .600	3/4 20
		14	41.00 1.614	41.00 1.614	29.35 1.156	25.10 .988	18.15 .715	7/8 20
		16	41.00 1.614	41.00 1.614	32.50 1.280	28.13 1.107	21.32 .839	1-20
		18	41.00 1.614	41.00 1.614	35.30 1.390	31.38 1.235	24.32 .957	1-3/16 18
		20	44.00 1.732	43.30 1.705	38.85 1.530	34.30 1.350	26.73 1.052	1-3/16 18
		22	44.00 1.732	43.30 1.705	42.05 1.656	37.60 1.480	30.67 1.207	1-7/16 18
		24	44.00 1.732	43.50 1.713	45.10 1.776	40.70 1.602	33.08 1.302	1-7/16 18

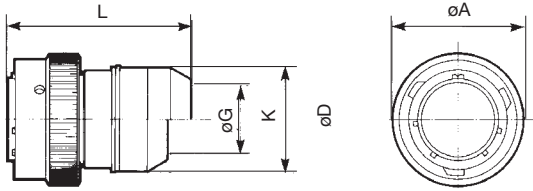

Plug with straight backshell for heatshrink sleeving

solder 06 T	crimp 06 RT	VG 95328 J	shell size	L Max		A	D Max	G Max		M Max
				solder	crimp			solder	crimp	
			08	36.70 1.445	36.00 1.417	19.05 .750	15.35 .604	7.20 .283	6.70 .264	3.70 .146
			10	36.70 1.445	36.00 1.417	21.80 .858	18.15 .715	10.20 .402	9.40 .370	3.70 .146
			12	36.70 1.445	36.00 1.417	26.15 1.030	23.45 .923	13.20 .520	11.95 .470	3.70 .146
			14	36.70 1.445	36.00 1.417	29.35 1.156	24.25 .955	16.10 .634	15.15 .596	3.70 .146
			16	39.00 1.535	38.30 1.508	32.50 1.280	29.55 1.163	19.25 .758	18.05 .711	3.70 .146
			18	39.00 1.535	38.30 1.508	35.30 1.390	31.75 1.250	21.30 .839	19.95 .785	3.70 .146
			20	44.00 1.732	42.90 1.689	38.85 1.530	35.85 1.411	24.40 .961	23.05 .907	3.70 .146
			22	44.00 1.732	42.90 1.689	42.05 1.656	38.20 1.504	27.50 1.083	25.55 1.006	3.70 .146
			24	42.70 1.681	41.60 1.638	45.10 1.776	41.30 1.626	30.60 1.205	28.65 1.128	3.70 .146

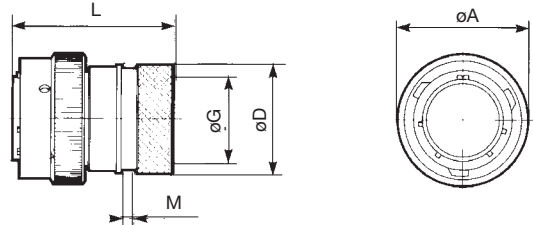

Plug with removable straight backshell for heatshrink sleeving

solder 06 M	crimp 06 RM	shell size	L Max		A Max	D Max	G Max	M Max
			solder/crimp					
		08	50.00 1.969		19.05 .750	13.55 .533	7.05 .278	3.50 .138
		10	50.00 1.969		21.80 .858	15.35 .604	9.90 .390	3.50 .138
		12	50.00 1.969		26.15 1.030	19.48 .767	12.60 .496	3.50 .138
		14	50.00 1.969		29.35 1.156	21.30 .839	15.90 .626	3.50 .138
		16	50.00 1.969		32.50 1.280	24.50 .965	18.95 .746	3.50 .138
		18	50.00 1.969		35.30 1.390	26.45 1.041	20.90 .823	3.50 .138
		20	52.00 2.047		38.85 1.530	30.73 1.210	23.70 .933	3.50 .138
		22	52.00 2.047		42.05 1.656	34.24 1.348	26.60 1.047	3.50 .138
		24	52.00 2.047		45.10 1.776	36.47 1.436	29.30 1.154	3.50 .138

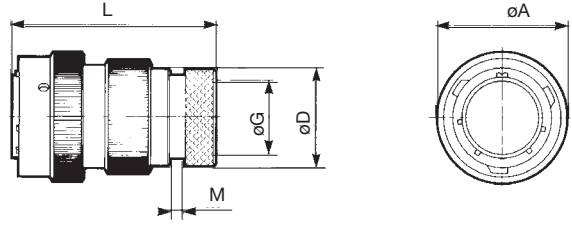

851 Series



Plug with straight sealing gland backshell

solder 06 J	HE 301 B 06 J		<table border="1"> <thead> <tr> <th rowspan="2">shell size</th> <th>L Max</th> <th>A</th> <th>D</th> <th colspan="2">G</th> </tr> <tr> <th>solder</th> <th>Max</th> <th>Max</th> <th>min</th> <th>Max</th> </tr> </thead> <tbody> <tr><td>08</td><td>47.60 1.874</td><td>19.05 .750</td><td>14.40 .567</td><td>5.02 .198</td><td>5.84 .230</td></tr> <tr><td>10</td><td>47.60 1.874</td><td>21.80 .858</td><td>17.60 .693</td><td>5.94 .234</td><td>6.76 .266</td></tr> <tr><td>12</td><td>49.20 1.937</td><td>26.15 1.030</td><td>21.10 .831</td><td>9.34 .368</td><td>10.16 .400</td></tr> <tr><td>14</td><td>54.00 2.126</td><td>29.35 1.156</td><td>24.40 .961</td><td>11.32 .446</td><td>12.14 .478</td></tr> <tr><td>16</td><td>59.60 2.346</td><td>32.50 1.280</td><td>27.60 1.087</td><td>14.73 .580</td><td>15.55 .612</td></tr> <tr><td>18</td><td>65.60 2.583</td><td>35.30 1.390</td><td>30.80 1.213</td><td>16.00 .630</td><td>16.80 .661</td></tr> <tr><td>20</td><td>78.00 3.071</td><td>38.85 1.530</td><td>34.10 1.343</td><td>16.89 .665</td><td>17.71 .697</td></tr> <tr><td>22</td><td>79.50 3.130</td><td>42.05 1.656</td><td>37.30 1.469</td><td>17.78 .700</td><td>18.60 .732</td></tr> <tr><td>24</td><td>90.00 3.543</td><td>45.10 1.776</td><td>40.50 1.594</td><td>20.34 .801</td><td>21.16 .833</td></tr> </tbody> </table>	shell size	L Max	A	D	G		solder	Max	Max	min	Max	08	47.60 1.874	19.05 .750	14.40 .567	5.02 .198	5.84 .230	10	47.60 1.874	21.80 .858	17.60 .693	5.94 .234	6.76 .266	12	49.20 1.937	26.15 1.030	21.10 .831	9.34 .368	10.16 .400	14	54.00 2.126	29.35 1.156	24.40 .961	11.32 .446	12.14 .478	16	59.60 2.346	32.50 1.280	27.60 1.087	14.73 .580	15.55 .612	18	65.60 2.583	35.30 1.390	30.80 1.213	16.00 .630	16.80 .661	20	78.00 3.071	38.85 1.530	34.10 1.343	16.89 .665	17.71 .697	22	79.50 3.130	42.05 1.656	37.30 1.469	17.78 .700	18.60 .732	24	90.00 3.543	45.10 1.776	40.50 1.594	20.34 .801	21.16 .833
shell size	L Max				A	D	G																																																													
	solder	Max	Max	min	Max																																																															
08	47.60 1.874	19.05 .750	14.40 .567	5.02 .198	5.84 .230																																																															
10	47.60 1.874	21.80 .858	17.60 .693	5.94 .234	6.76 .266																																																															
12	49.20 1.937	26.15 1.030	21.10 .831	9.34 .368	10.16 .400																																																															
14	54.00 2.126	29.35 1.156	24.40 .961	11.32 .446	12.14 .478																																																															
16	59.60 2.346	32.50 1.280	27.60 1.087	14.73 .580	15.55 .612																																																															
18	65.60 2.583	35.30 1.390	30.80 1.213	16.00 .630	16.80 .661																																																															
20	78.00 3.071	38.85 1.530	34.10 1.343	16.89 .665	17.71 .697																																																															
22	79.50 3.130	42.05 1.656	37.30 1.469	17.78 .700	18.60 .732																																																															
24	90.00 3.543	45.10 1.776	40.50 1.594	20.34 .801	21.16 .833																																																															

Plug with straight sealing gland and cable clamp backshell

solder 06 JC	MS 3116 J		<table border="1"> <thead> <tr> <th rowspan="2">shell size</th> <th>L Max</th> <th>A</th> <th>D</th> <th colspan="2">G</th> </tr> <tr> <th>solder</th> <th>Max</th> <th>Max</th> <th>min</th> <th>Max</th> </tr> </thead> <tbody> <tr><td>08</td><td>57.68 2.271</td><td>19.05 .750</td><td>19.90 .783</td><td>5.02 .198</td><td>5.84 .230</td></tr> <tr><td>10</td><td>57.68 2.271</td><td>21.80 .858</td><td>21.50 .846</td><td>5.94 .234</td><td>6.76 .266</td></tr> <tr><td>12</td><td>61.24 2.411</td><td>26.15 1.030</td><td>25.00 .984</td><td>9.34 .368</td><td>10.16 .400</td></tr> <tr><td>14</td><td>66.01 2.599</td><td>29.35 1.156</td><td>27.80 1.094</td><td>11.32 .446</td><td>12.14 .478</td></tr> <tr><td>16</td><td>74.75 2.943</td><td>32.50 1.280</td><td>29.40 1.157</td><td>14.73 .580</td><td>15.50 .610</td></tr> <tr><td>18</td><td>80.57 3.172</td><td>35.30 1.390</td><td>35.30 1.390</td><td>16.00 .630</td><td>16.82 .662</td></tr> <tr><td>20</td><td>91.69 3.610</td><td>38.85 1.530</td><td>35.30 1.390</td><td>16.89 .665</td><td>17.71 .697</td></tr> <tr><td>22</td><td>95.66 3.766</td><td>42.05 1.656</td><td>41.10 1.618</td><td>17.78 .700</td><td>18.60 .732</td></tr> <tr><td>24</td><td>101.22 3.985</td><td>45.10 1.776</td><td>42.40 1.669</td><td>20.34 .801</td><td>21.16 .833</td></tr> </tbody> </table>	shell size	L Max	A	D	G		solder	Max	Max	min	Max	08	57.68 2.271	19.05 .750	19.90 .783	5.02 .198	5.84 .230	10	57.68 2.271	21.80 .858	21.50 .846	5.94 .234	6.76 .266	12	61.24 2.411	26.15 1.030	25.00 .984	9.34 .368	10.16 .400	14	66.01 2.599	29.35 1.156	27.80 1.094	11.32 .446	12.14 .478	16	74.75 2.943	32.50 1.280	29.40 1.157	14.73 .580	15.50 .610	18	80.57 3.172	35.30 1.390	35.30 1.390	16.00 .630	16.82 .662	20	91.69 3.610	38.85 1.530	35.30 1.390	16.89 .665	17.71 .697	22	95.66 3.766	42.05 1.656	41.10 1.618	17.78 .700	18.60 .732	24	101.22 3.985	45.10 1.776	42.40 1.669	20.34 .801	21.16 .833
shell size	L Max				A	D	G																																																													
	solder	Max	Max	min	Max																																																															
08	57.68 2.271	19.05 .750	19.90 .783	5.02 .198	5.84 .230																																																															
10	57.68 2.271	21.80 .858	21.50 .846	5.94 .234	6.76 .266																																																															
12	61.24 2.411	26.15 1.030	25.00 .984	9.34 .368	10.16 .400																																																															
14	66.01 2.599	29.35 1.156	27.80 1.094	11.32 .446	12.14 .478																																																															
16	74.75 2.943	32.50 1.280	29.40 1.157	14.73 .580	15.50 .610																																																															
18	80.57 3.172	35.30 1.390	35.30 1.390	16.00 .630	16.82 .662																																																															
20	91.69 3.610	38.85 1.530	35.30 1.390	16.89 .665	17.71 .697																																																															
22	95.66 3.766	42.05 1.656	41.10 1.618	17.78 .700	18.60 .732																																																															
24	101.22 3.985	45.10 1.776	42.40 1.669	20.34 .801	21.16 .833																																																															

Plug with elbow cable clamp backshell

solder 08 EC	HE 301 B 08 EC		<table border="1"> <thead> <tr> <th rowspan="2">shell size</th> <th>L Max</th> <th>A</th> <th>D</th> <th>G</th> <th>R</th> </tr> <tr> <th>solder/crimp</th> <th>Max</th> <th>Max</th> <th></th> <th>Max</th> </tr> </thead> <tbody> <tr><td>08</td><td>50.10 1.972</td><td>19.05 .750</td><td>19.70 .776</td><td>3.50 .138</td><td>16.00 .630</td></tr> <tr><td>10</td><td>52.60 2.071</td><td>21.80 .858</td><td>21.20 .835</td><td>5.00 .197</td><td>18.00 .709</td></tr> <tr><td>12</td><td>54.90 2.161</td><td>26.15 1.030</td><td>24.20 .953</td><td>8.20 .323</td><td>19.50 .768</td></tr> <tr><td>14</td><td>58.50 2.303</td><td>29.35 1.156</td><td>27.50 1.083</td><td>10.00 .394</td><td>22.00 .866</td></tr> <tr><td>16</td><td>60.80 2.394</td><td>32.50 1.280</td><td>29.10 1.146</td><td>13.00 .512</td><td>23.50 .925</td></tr> <tr><td>18</td><td>65.00 2.559</td><td>35.30 1.390</td><td>35.70 1.406</td><td>16.00 .630</td><td>25.00 .984</td></tr> <tr><td>20</td><td>69.10 2.720</td><td>38.85 1.530</td><td>35.70 1.406</td><td>16.00 .630</td><td>26.50 1.043</td></tr> <tr><td>22</td><td>71.00 2.795</td><td>42.05 1.656</td><td>39.70 1.563</td><td>19.30 .760</td><td>28.00 1.102</td></tr> <tr><td>24</td><td>75.50 2.972</td><td>45.10 1.776</td><td>43.50 1.713</td><td>20.60 .811</td><td>31.00 1.220</td></tr> </tbody> </table>	shell size	L Max	A	D	G	R	solder/crimp	Max	Max		Max	08	50.10 1.972	19.05 .750	19.70 .776	3.50 .138	16.00 .630	10	52.60 2.071	21.80 .858	21.20 .835	5.00 .197	18.00 .709	12	54.90 2.161	26.15 1.030	24.20 .953	8.20 .323	19.50 .768	14	58.50 2.303	29.35 1.156	27.50 1.083	10.00 .394	22.00 .866	16	60.80 2.394	32.50 1.280	29.10 1.146	13.00 .512	23.50 .925	18	65.00 2.559	35.30 1.390	35.70 1.406	16.00 .630	25.00 .984	20	69.10 2.720	38.85 1.530	35.70 1.406	16.00 .630	26.50 1.043	22	71.00 2.795	42.05 1.656	39.70 1.563	19.30 .760	28.00 1.102	24	75.50 2.972	45.10 1.776	43.50 1.713	20.60 .811	31.00 1.220
shell size	L Max				A	D	G	R																																																												
	solder/crimp	Max	Max		Max																																																															
08	50.10 1.972	19.05 .750	19.70 .776	3.50 .138	16.00 .630																																																															
10	52.60 2.071	21.80 .858	21.20 .835	5.00 .197	18.00 .709																																																															
12	54.90 2.161	26.15 1.030	24.20 .953	8.20 .323	19.50 .768																																																															
14	58.50 2.303	29.35 1.156	27.50 1.083	10.00 .394	22.00 .866																																																															
16	60.80 2.394	32.50 1.280	29.10 1.146	13.00 .512	23.50 .925																																																															
18	65.00 2.559	35.30 1.390	35.70 1.406	16.00 .630	25.00 .984																																																															
20	69.10 2.720	38.85 1.530	35.70 1.406	16.00 .630	26.50 1.043																																																															
22	71.00 2.795	42.05 1.656	39.70 1.563	19.30 .760	28.00 1.102																																																															
24	75.50 2.972	45.10 1.776	43.50 1.713	20.60 .811	31.00 1.220																																																															

851 Series



Plug with elbow backshell for potting

solder 08 P	HE 301 B 08 P		<table border="1"> <thead> <tr> <th rowspan="2">shell size</th> <th>L Max</th> <th>A Max</th> <th>G Max</th> <th>R Max</th> <th>S Max</th> </tr> <tr> <th>solder/crimp</th> <th></th> <th></th> <th></th> <th></th> </tr> </thead> <tbody> <tr><td>08</td><td>40.70 1.602</td><td>19.05 .750</td><td>8.10 .319</td><td>11.70 .461</td><td>11.30 .445</td></tr> <tr><td>10</td><td>44.90 1.768</td><td>21.80 .858</td><td>11.30 .445</td><td>14.35 .565</td><td>14.50 .571</td></tr> <tr><td>12</td><td>46.90 1.846</td><td>26.15 1.030</td><td>13.30 .524</td><td>15.90 .626</td><td>17.70 .697</td></tr> <tr><td>14</td><td>49.20 1.937</td><td>29.35 1.156</td><td>16.10 .634</td><td>16.30 .642</td><td>20.10 .791</td></tr> <tr><td>16</td><td>50.60 1.992</td><td>32.50 1.280</td><td>16.90 .665</td><td>19.30 .760</td><td>22.80 .898</td></tr> <tr><td>18</td><td>51.80 2.039</td><td>35.30 1.390</td><td>18.10 .713</td><td>20.60 .811</td><td>25.60 1.008</td></tr> <tr><td>20</td><td>53.70 2.114</td><td>38.85 1.530</td><td>19.70 .776</td><td>21.90 .862</td><td>28.80 1.134</td></tr> <tr><td>22</td><td>54.80 2.157</td><td>42.05 1.656</td><td>20.80 .819</td><td>23.50 .925</td><td>31.60 1.244</td></tr> <tr><td>24</td><td>58.20 2.291</td><td>45.10 1.776</td><td>24.20 .953</td><td>30.15 1.187</td><td>35.20 1.386</td></tr> </tbody> </table>	shell size	L Max	A Max	G Max	R Max	S Max	solder/crimp					08	40.70 1.602	19.05 .750	8.10 .319	11.70 .461	11.30 .445	10	44.90 1.768	21.80 .858	11.30 .445	14.35 .565	14.50 .571	12	46.90 1.846	26.15 1.030	13.30 .524	15.90 .626	17.70 .697	14	49.20 1.937	29.35 1.156	16.10 .634	16.30 .642	20.10 .791	16	50.60 1.992	32.50 1.280	16.90 .665	19.30 .760	22.80 .898	18	51.80 2.039	35.30 1.390	18.10 .713	20.60 .811	25.60 1.008	20	53.70 2.114	38.85 1.530	19.70 .776	21.90 .862	28.80 1.134	22	54.80 2.157	42.05 1.656	20.80 .819	23.50 .925	31.60 1.244	24	58.20 2.291	45.10 1.776	24.20 .953	30.15 1.187	35.20 1.386
shell size	L Max				A Max	G Max	R Max	S Max																																																												
	solder/crimp																																																																			
08	40.70 1.602	19.05 .750	8.10 .319	11.70 .461	11.30 .445																																																															
10	44.90 1.768	21.80 .858	11.30 .445	14.35 .565	14.50 .571																																																															
12	46.90 1.846	26.15 1.030	13.30 .524	15.90 .626	17.70 .697																																																															
14	49.20 1.937	29.35 1.156	16.10 .634	16.30 .642	20.10 .791																																																															
16	50.60 1.992	32.50 1.280	16.90 .665	19.30 .760	22.80 .898																																																															
18	51.80 2.039	35.30 1.390	18.10 .713	20.60 .811	25.60 1.008																																																															
20	53.70 2.114	38.85 1.530	19.70 .776	21.90 .862	28.80 1.134																																																															
22	54.80 2.157	42.05 1.656	20.80 .819	23.50 .925	31.60 1.244																																																															
24	58.20 2.291	45.10 1.776	24.20 .953	30.15 1.187	35.20 1.386																																																															
crimp 08 RP	HE 301 B 08 RP																																																																			

Screened plug with straight adapter

solder 36 A			<table border="1"> <thead> <tr> <th rowspan="2">shell size</th> <th>L Max</th> <th>A Max</th> <th>D Max</th> <th>G Max</th> <th>K</th> </tr> <tr> <th>solder/crimp</th> <th></th> <th></th> <th></th> <th>threading UNEF 2 A</th> </tr> </thead> <tbody> <tr><td>08</td><td>41.00 1.614</td><td>19.05 .750</td><td>14.50 .571</td><td>9.10 .358</td><td>1/2 28</td></tr> <tr><td>10</td><td>41.00 1.614</td><td>21.80 .858</td><td>18.70 .736</td><td>12.08 .476</td><td>5/8 24</td></tr> <tr><td>12</td><td>41.00 1.614</td><td>26.15 1.030</td><td>21.70 .854</td><td>15.25 .600</td><td>3/4 20</td></tr> <tr><td>14</td><td>41.00 1.614</td><td>29.35 1.156</td><td>25.10 .988</td><td>18.15 .715</td><td>7/8 20</td></tr> <tr><td>16</td><td>41.00 1.614</td><td>32.50 1.280</td><td>28.13 1.107</td><td>21.32 .839</td><td>1-20</td></tr> <tr><td>18</td><td>41.00 1.614</td><td>35.30 1.390</td><td>31.38 1.235</td><td>24.32 .957</td><td>1-3/16 18</td></tr> <tr><td>20</td><td>43.30 1.705</td><td>38.85 1.530</td><td>34.30 1.350</td><td>26.73 1.052</td><td>1-3/16 18</td></tr> <tr><td>22</td><td>43.30 1.705</td><td>42.05 1.656</td><td>37.60 1.480</td><td>30.67 1.207</td><td>1-7/16 18</td></tr> <tr><td>24</td><td>43.50 1.713</td><td>45.10 1.776</td><td>40.70 1.602</td><td>33.08 1.302</td><td>1-7/16 18</td></tr> </tbody> </table>	shell size	L Max	A Max	D Max	G Max	K	solder/crimp				threading UNEF 2 A	08	41.00 1.614	19.05 .750	14.50 .571	9.10 .358	1/2 28	10	41.00 1.614	21.80 .858	18.70 .736	12.08 .476	5/8 24	12	41.00 1.614	26.15 1.030	21.70 .854	15.25 .600	3/4 20	14	41.00 1.614	29.35 1.156	25.10 .988	18.15 .715	7/8 20	16	41.00 1.614	32.50 1.280	28.13 1.107	21.32 .839	1-20	18	41.00 1.614	35.30 1.390	31.38 1.235	24.32 .957	1-3/16 18	20	43.30 1.705	38.85 1.530	34.30 1.350	26.73 1.052	1-3/16 18	22	43.30 1.705	42.05 1.656	37.60 1.480	30.67 1.207	1-7/16 18	24	43.50 1.713	45.10 1.776	40.70 1.602	33.08 1.302	1-7/16 18
shell size	L Max				A Max	D Max	G Max	K																																																												
	solder/crimp				threading UNEF 2 A																																																															
08	41.00 1.614	19.05 .750	14.50 .571	9.10 .358	1/2 28																																																															
10	41.00 1.614	21.80 .858	18.70 .736	12.08 .476	5/8 24																																																															
12	41.00 1.614	26.15 1.030	21.70 .854	15.25 .600	3/4 20																																																															
14	41.00 1.614	29.35 1.156	25.10 .988	18.15 .715	7/8 20																																																															
16	41.00 1.614	32.50 1.280	28.13 1.107	21.32 .839	1-20																																																															
18	41.00 1.614	35.30 1.390	31.38 1.235	24.32 .957	1-3/16 18																																																															
20	43.30 1.705	38.85 1.530	34.30 1.350	26.73 1.052	1-3/16 18																																																															
22	43.30 1.705	42.05 1.656	37.60 1.480	30.67 1.207	1-7/16 18																																																															
24	43.50 1.713	45.10 1.776	40.70 1.602	33.08 1.302	1-7/16 18																																																															
crimp 36 RA	VG 95328 N																																																																			

Screened plug with removable straight backshell for screen termination and heatshrink sleeving (38 and 42 suffix)

solder 36 T			<table border="1"> <thead> <tr> <th rowspan="2">shell size</th> <th>L Max</th> <th>A Max</th> <th>D Max</th> <th>G Max</th> <th>M Max</th> </tr> <tr> <th>solder/crimp</th> <th></th> <th></th> <th></th> <th></th> </tr> </thead> <tbody> <tr><td>08</td><td>51.60 2.031</td><td>19.05 .750</td><td>18.25 .719</td><td>7.45 .293</td><td>3.70 .146</td></tr> <tr><td>10</td><td>51.60 2.031</td><td>21.80 .858</td><td>20.25 .797</td><td>9.00 .354</td><td>3.70 .146</td></tr> <tr><td>12</td><td>51.60 2.031</td><td>26.15 1.030</td><td>24.75 .974</td><td>13.30 .524</td><td>3.70 .146</td></tr> <tr><td>14</td><td>51.60 2.031</td><td>29.35 1.156</td><td>27.75 1.093</td><td>16.50 .650</td><td>3.70 .146</td></tr> <tr><td>16</td><td>51.60 2.031</td><td>32.50 1.280</td><td>30.05 1.183</td><td>18.50 .728</td><td>3.70 .146</td></tr> <tr><td>18</td><td>52.00 2.047</td><td>35.30 1.390</td><td>34.15 1.344</td><td>21.90 .862</td><td>3.70 .146</td></tr> <tr><td>20</td><td>53.90 2.122</td><td>38.85 1.530</td><td>37.25 1.467</td><td>25.10 .988</td><td>3.70 .146</td></tr> <tr><td>22</td><td>53.90 2.122</td><td>42.05 1.656</td><td>40.45 1.593</td><td>28.20 1.110</td><td>3.70 .146</td></tr> <tr><td>24</td><td>53.90 2.122</td><td>45.10 1.776</td><td>43.65 1.719</td><td>31.40 1.236</td><td>3.70 .146</td></tr> </tbody> </table>	shell size	L Max	A Max	D Max	G Max	M Max	solder/crimp					08	51.60 2.031	19.05 .750	18.25 .719	7.45 .293	3.70 .146	10	51.60 2.031	21.80 .858	20.25 .797	9.00 .354	3.70 .146	12	51.60 2.031	26.15 1.030	24.75 .974	13.30 .524	3.70 .146	14	51.60 2.031	29.35 1.156	27.75 1.093	16.50 .650	3.70 .146	16	51.60 2.031	32.50 1.280	30.05 1.183	18.50 .728	3.70 .146	18	52.00 2.047	35.30 1.390	34.15 1.344	21.90 .862	3.70 .146	20	53.90 2.122	38.85 1.530	37.25 1.467	25.10 .988	3.70 .146	22	53.90 2.122	42.05 1.656	40.45 1.593	28.20 1.110	3.70 .146	24	53.90 2.122	45.10 1.776	43.65 1.719	31.40 1.236	3.70 .146
shell size	L Max				A Max	D Max	G Max	M Max																																																												
	solder/crimp																																																																			
08	51.60 2.031	19.05 .750	18.25 .719	7.45 .293	3.70 .146																																																															
10	51.60 2.031	21.80 .858	20.25 .797	9.00 .354	3.70 .146																																																															
12	51.60 2.031	26.15 1.030	24.75 .974	13.30 .524	3.70 .146																																																															
14	51.60 2.031	29.35 1.156	27.75 1.093	16.50 .650	3.70 .146																																																															
16	51.60 2.031	32.50 1.280	30.05 1.183	18.50 .728	3.70 .146																																																															
18	52.00 2.047	35.30 1.390	34.15 1.344	21.90 .862	3.70 .146																																																															
20	53.90 2.122	38.85 1.530	37.25 1.467	25.10 .988	3.70 .146																																																															
22	53.90 2.122	42.05 1.656	40.45 1.593	28.20 1.110	3.70 .146																																																															
24	53.90 2.122	45.10 1.776	43.65 1.719	31.40 1.236	3.70 .146																																																															
crimp 36 RT																																																																				



851 Series

Screened plug with removable straight backshell for screen termination and heatshrink sleeving

solder 36 G		shell size	L Max	A	D	G	M
crimp 36 RG	VG 95328 M		solder/crimp	Max	Max	Max	Max
		08	54.00 2.126	19.05 .750	16.30 .642	7.45 .293	3.60 .142
		10	54.00 2.126	21.80 .858	18.30 .720	10.30 .406	3.60 .142
		12	54.00 2.126	26.15 1.030	22.30 .878	13.20 .520	3.60 .142
		14	54.00 2.126	29.35 1.156	25.30 .996	16.50 .650	3.60 .142
		16	54.00 2.126	32.50 1.280	28.30 1.114	19.35 .762	3.60 .142
		18	54.00 2.126	35.30 1.390	32.30 1.272	21.60 .850	3.60 .142
		20	58.00 2.283	38.85 1.530	34.30 1.350	24.80 .976	3.60 .142
		22	58.00 2.283	42.05 1.656	38.30 1.508	27.90 1.098	3.60 .142
		24	58.00 2.283	45.10 1.776	41.30 1.626	31.00 1.220	3.60 .142

Plug with straight adapter for electrical pitch access

solder 06 Z		shell size	L Max	A	B	C	D
crimp 06 RZ			solder/crimp	Max	Max	Max	threading PE
		08	-	-	-	-	-
		10	-	-	-	-	-
		12	43.00 1.693	26.15 1.030	9.00 .354	24.80 .976	11
		14	45.00 1.772	29.35 1.156	11.00 .433	28.80 1.134	16
		16	45.00 1.772	32.50 1.280	11.00 .433	30.80 1.213	16
		18	46.00 1.811	35.30 1.390	12.00 .472	40.80 1.606	21
		20	46.50 1.831	38.85 1.530	12.00 .472	40.80 1.606	21
		22	46.50 1.831	42.05 1.656	12.00 .472	40.80 1.606	21
		24	65.50 2.579	45.10 1.776	31.40 1.236	45.00 1.772	29

Screened plug with lock finger and short backshell for screen termination and heatshrink sleeving

solder 76 U		shell size	L Max	A	D	H	G	E	M
crimp 76 RU	VG 95328 U		solder/crimp	Max	Max	Max	Max	Max	Max
		08	-	-	-	-	-	-	-
		10	-	-	-	-	-	-	-
		12	35.60 1.402	25.00 .984	22.50 .886	32.00 1.260	13.20 .520	19.50 .768	3.70 .146
		14	35.60 1.402	29.00 1.142	25.50 1.004	32.00 1.260	16.10 .634	21.00 .827	3.70 .146
		16	35.60 1.402	32.00 1.260	28.50 1.122	32.00 1.260	19.25 .758	22.50 .886	3.70 .146
		18	-	-	-	-	-	-	-
		20	-	-	-	-	-	-	-
		22	-	-	-	-	-	-	-
		24	-	-	-	-	-	-	-

851 Series

Hermetic connectors



square flange receptacle 02 H HE 301 B 02 H		shell size	A	C Max	D Max	E	F	G	H Max	J	M Max	N Max
	08	12.03 .474	21.42 .843	27.09 1.067	15.09 .594	13.84 .545	14.27 .562	6.97 .274	3.13 .123	11.24 .443	1.67 .066	
	10	15.01 .591	24.62 .969	31.87 1.255	18.26 .719	13.84 .545	17.06 .672	6.97 .274	3.13 .123	11.24 .443	1.67 .066	
	12	19.07 .751	26.98 1.062	35.04 1.380	20.62 .812	13.84 .545	19.85 .781	6.97 .274	3.13 .123	11.24 .443	1.67 .066	
	14	22.25 .876	29.36 1.156	38.22 1.505	23.00 .906	13.84 .545	23.00 .906	6.97 .274	3.13 .123	11.24 .443	1.67 .066	
	16	25.42 1.001	31.73 1.249	41.39 1.630	24.61 .969	13.84 .545	26.18 1.031	6.97 .274	3.13 .123	11.24 .443	1.67 .066	
	18	28.60 1.126	34.12 1.343	44.57 1.755	26.97 1.062	13.84 .545	29.36 1.156	6.97 .274	3.13 .123	11.24 .443	1.67 .066	
	20	31.77 1.251	37.20 1.465	47.74 1.880	29.36 1.156	15.42 .607	31.74 1.250	6.99 .275	3.13 .123	12.00 .472	2.48 .098	
	22	34.95 1.376	40.47 1.593	50.92 2.005	31.75 1.250	16.23 .639	34.92 1.375	6.99 .275	3.13 .123	12.00 .472	2.48 .098	
	24	38.12 1.501	43.66 1.719	55.69 2.193	34.92 1.375	17.04 .671	38.10 1.500	6.19 .244	3.81 .150	12.81 .504	2.48 .098	

jam nut receptacle 07 H HE 301 B 07 H MS 3114 H VG 95328 F		shell size	A	C Max	D Max	G	L Max	M Max	P
	08	12.03 .474	24.07 .948	27.37 1.078	14.26 .561	20.53 .808	17.93 .706	13.33 .525	
	10	15.01 .591	27.22 1.072	30.57 1.204	17.43 .686	20.53 .808	17.93 .706	16.51 .650	
	12	19.07 .751	32.00 1.260	35.32 1.391	22.19 .874	20.53 .808	17.93 .706	20.63 .812	
	14	22.25 .876	35.17 1.385	38.50 1.516	25.36 .998	20.53 .808	17.93 .706	23.78 .936	
	16	25.42 1.001	38.35 1.510	41.67 1.641	28.54 1.124	20.53 .808	17.93 .706	26.93 1.060	
	18	28.60 1.126	41.52 1.635	44.85 1.766	31.71 1.248	20.53 .808	17.93 .706	30.10 1.185	
	20	31.77 1.251	46.27 1.822	49.62 1.954	34.89 1.374	26.10 1.028	22.70 .894	33.28 1.310	
	22	34.95 1.376	49.47 1.948	52.77 2.078	38.06 1.498	26.10 1.028	22.70 .894	36.45 1.435	
	24	38.12 1.501	52.62 2.072	55.97 2.204	41.24 1.624	26.93 1.060	23.54 .927	39.63 1.560	

solder fixing receptacle IH HE 301 B 1 H MS 3113 H VG 95328 G		shell size	A	D Max	H Max	F	G Max	M Max	N Max
	08	12.03 .474	16.40 .646	8.19 .322	13.84 .545	14.27 .562	10.69 .421	0.76 .030	
	10	15.01 .591	19.40 .764	8.19 .322	13.84 .545	17.06 .672	10.69 .421	0.76 .030	
	12	19.07 .751	21.80 .858	8.19 .322	13.84 .545	19.83 .781	10.69 .421	0.76 .030	
	14	22.25 .876	25.00 .984	8.19 .322	13.84 .545	23.00 .906	10.69 .421	0.76 .030	
	16	25.42 1.001	28.10 1.106	8.19 .322	13.84 .545	26.18 1.031	10.69 .421	0.76 .030	
	18	28.60 1.126	31.30 1.232	8.19 .322	13.84 .545	29.36 1.156	10.69 .421	0.76 .030	
	20	31.77 1.251	33.70 1.327	8.16 .321	15.42 .607	31.74 1.250	12.32 .485	0.76 .030	
	22	34.95 1.376	36.90 1.453	8.16 .321	16.23 .639	34.92 1.375	12.32 .485	0.76 .030	
	24	38.12 1.501	40.10 1.579	7.36 .290	17.04 .671	38.10 1.500	13.12 .517	0.76 .030	

851 Series

Wire wrap and straight spills connectors



Square flange receptacle type 02 E

shell size	wire wrap version		straight spills version		A	B Max	C Max	Ø D Max	E	F Max	H	J	L Max	T	
	Ø A	Ø D	Ø A	Ø D											
08	12.03 .474	11.70 .461	1.32 .052	10.84 .427	15.09 .594	20.99 .826	12.42 .489	3.13 .123	20.50 .807	9.46 .372					
10	15.01 .591	11.70 .461	1.32 .052	13.99 .551	18.26 .719	24.19 .952	12.42 .489	3.13 .123	20.50 .807	9.46 .372					
12	19.07 .751	11.70 .461	1.32 .052	17.37 .684	20.62 .812	26.54 1.045	12.42 .489	3.13 .123	20.50 .807	9.46 .372					
14	22.25 .876	11.70 .461	1.32 .052	20.57 .810	23.00 .906	28.89 1.137	12.42 .489	3.13 .123	20.50 .807	9.46 .372					
16	25.42 1.001	11.70 .461	1.32 .052	23.62 .930	24.61 .969	31.29 1.232	12.42 .489	3.13 .123	20.50 .807	9.46 .372					
18	28.60 1.126	11.70 .461	1.32 .052	26.69 1.051	26.97 1.062	33.69 1.326	12.42 .489	3.13 .123	20.50 .807	9.46 .372					
20	31.77 1.251	14.35 .565	2.15 .085	29.89 1.177	29.36 1.156	36.89 1.452	10.69 .421	3.13 .123	23.80 .937	7.76 .306					
22	34.95 1.376	14.35 .565	2.15 .085	33.04 1.301	31.75 1.250	39.99 1.574	10.69 .421	3.13 .123	23.80 .937	7.76 .306					
24	38.12 1.501	15.20 .598	2.15 .085	36.24 1.427	34.92 1.375	43.15 1.699	10.69 .421	3.81 .150	23.80 .937	7.76 .306					

Jam nut receptacle type 07 A

shell size	wire wrap version		straight spills version		A	B Max	C Max	F Max	H	L Max	P Max	S Max	T
	Ø A	Ø F	Ø A	Ø F									
08	12.03 .474	17.90 .705	2.64 .104	26.94 1.061	12.42 .489	20.64 .813	19.29 .759	23.94 .943	9.46 .372				
10	15.01 .591	17.90 .705	2.64 .104	30.14 1.187	12.42 .489	20.64 .813	22.38 .881	26.95 1.061	9.46 .372				
12	19.07 .751	17.90 .705	2.64 .104	34.94 1.376	12.42 .489	20.64 .813	27.13 1.068	31.74 1.250	9.46 .372				
14	22.25 .876	17.90 .705	2.64 .104	38.04 1.498	12.42 .489	20.64 .813	30.33 1.194	34.94 1.376	9.46 .372				
16	25.42 1.001	17.90 .705	2.64 .104	41.26 1.624	12.42 .489	20.64 .813	33.48 1.318	38.24 1.506	9.46 .372				
18	28.60 1.126	17.90 .705	2.64 .104	44.44 1.750	12.42 .489	20.64 .813	36.68 1.444	41.34 1.628	9.46 .372				
20	31.77 1.251	22.45 .884	3.44 .135	49.14 1.935	8.64 .340	25.99 1.023	39.83 1.568	46.04 1.813	8.49 .334				
22	34.95 1.376	22.45 .884	3.44 .135	52.24 2.057	8.64 .340	25.99 1.023	43.03 1.694	49.24 1.939	8.49 .334				
24	38.12 1.501	23.30 .917	3.44 .135	55.54 2.187	7.79 .307	26.84 1.057	46.18 1.818	52.74 2.076	7.79 .307				

851 Series



Caps

Part numbers

basic series	8500									05	•••
shell size	8	10	12	14	16	18	20	22	24		
part numbers for receptacle	02	03	04	05	27	06	07	08	09		
part numbers for plug	10	11	12	13	28	14	15	16	17		
specification	for cap type and plating										

Type and plating

Cap type	receptacle cap				plug cap			
	olive green cadmium	white cadmium	black anodized	nickel	olive green cadmium	white cadmium	black anodized	nickel
cap with chain and ring	D	02 D	29 D	44 D	D	02 D	29 D	44 D
cap with nylon cord and ring	B	02 B	29 B	44 B	B	02 B	29 B	44 B
cap with nylon cord and washer (shell 10, 12 and 14)	-	-	-	-	E	-	-	-
cap with nylon cord and washer	H	-	-	-	-	-	-	-
cap with chain and washer	J	-	-	-	-	-	-	-

Caps for plug

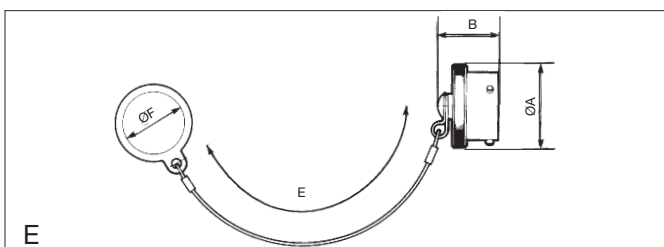
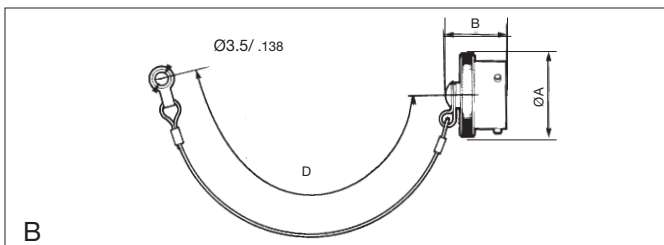
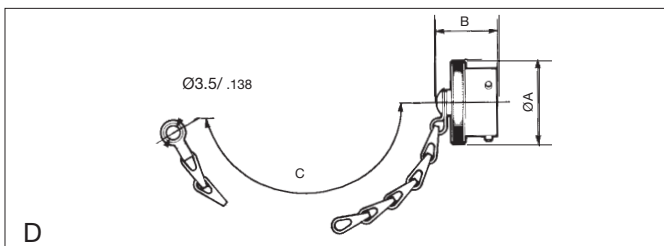

shell size	Ø A Maxi	B Maxi	C	D	E	Ø F
08	16.80 .661	19.84 .781	132.00 5.197	128.00 5.039	-	-
10	19.80 .780	19.84 .781	132.00 5.197	128.00 5.039	132.00 5.197	14.00 .551
12	23.90 .941	19.84 .781	148.00 5.827	148.00 5.827	148.00 5.827	17.60 .693
14	27.00 1.063	19.84 .781	148.00 5.827	148.00 5.827	148.00 5.827	20.80 .819
16	30.20 1.189	19.84 .781	148.00 5.827	148.00 5.827	-	-
18	33.40 1.315	19.84 .781	148.00 5.827	148.00 5.827	-	-
20	36.50 1.437	21.44 .844	168.00 6.614	153.00 6.024	-	-
22	39.80 1.567	21.44 .844	168.00 6.614	153.00 6.024	-	-
24	42.90 1.689	22.22 .875	168.00 6.614	153.00 6.024	-	-

851 Series



Caps for receptacle

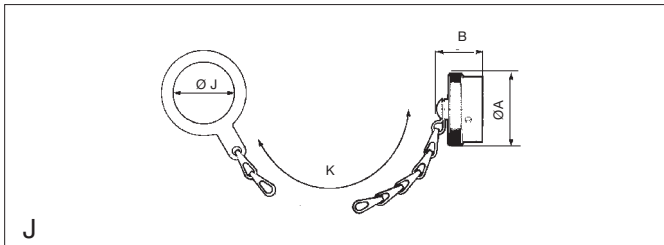
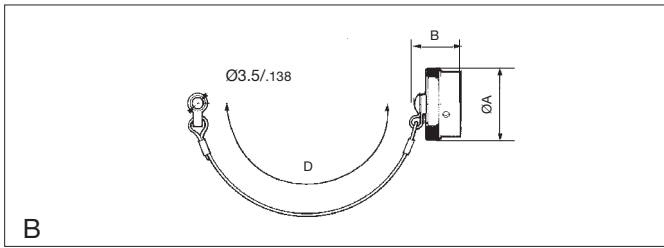
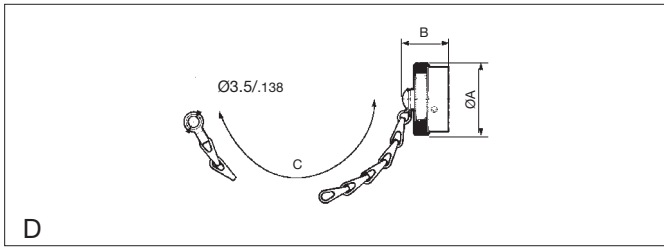

shell size	Ø A Max	B Max	C	D	J Max	H	K
08	19.00 .748	21.44 .844	84.00 3.307	77.00 3.031	14.80 .583	80.00 3.150	84.00 3.307
10	21.80 .858	21.44 .844	84.00 3.307	77.00 3.031	17.90 .705	80.00 3.150	84.00 3.307
12	26.10 1.028	21.44 .844	100.00 3.937	89.00 3.504	22.70 .894	90.00 3.543	100.00 3.937
14	29.30 1.154	21.44 .844	100.00 3.937	89.00 3.504	25.90 1.020	90.00 3.543	100.00 3.937
16	32.50 1.280	21.44 .844	100.00 3.937	89.00 3.504	29.00 1.142	90.00 3.543	100.00 3.937
18	35.30 1.390	21.44 .844	100.00 3.937	89.00 3.504	32.20 1.268	90.00 3.543	100.00 3.937
20	38.80 1.528	21.44 .844	116.00 4.567	102.00 4.016	35.40 1.394	110.00 4.331	116.00 4.567
22	42.00 1.654	21.44 .844	116.00 4.567	102.00 4.016	38.60 1.520	110.00 4.331	116.00 4.567
24	45.10 1.776	22.22 .875	116.00 4.567	102.00 4.016	41.70 1.642	110.00 4.331	116.00 4.567

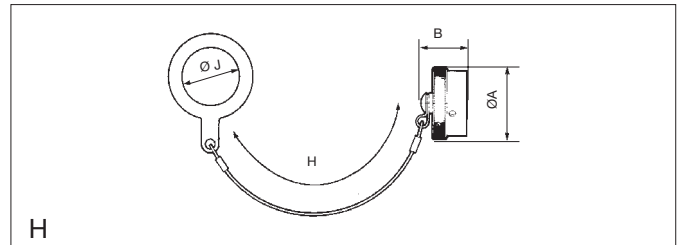

Tools Crimping pliers

contact sizes	wire size		part numbers	
	mm ²	AWG	crimping tool	locator
20	0,93	18	8465 (MS 3191-1) 8476-01 (M 22520 / 2-01) 8365 (M 22520 / 1-01)	MS 3191-20 A 8476-02 (M 22520 / 2-02) 8365-02 (M 22520 / 1-02)
	0,60	20		
	0,38	22		
	0,21	24		
16	1,91	14	8465 (MS 3191-1) 8365 (M 22520 / 1-01)	MS 3191-16 A 8365-02 (M 22520 / 1-02)
	1,34	16		
	0,93	18		

Insertion and extraction tools

contact type	contact size	part numbers	
		insertion tools	extraction tools
crimp	20	8500-29 B *	8500-36 A
	16	8500-39	8500-38 A
for wire cap	20	8500-31	8500-31
	16	or 8500-39 8500-37	8500-37

Spare tube for tool : - 8500-36 A PN : 8500-1163
- 8500-38 A PN : 8500-1184

* Except 8-2, 8-3, 8-4, 12-14 contact layouts :
insertion tool 8500-93B

Filler plug

contact size	part numbers	colour	profile
20	8500-4144	grey	
16	8500-479	blue	
20	8500-4144 A (MS 3187 A 20)	red	
16	8500-4267 (MS 3187-16)	blue	

851 Series



Panel cut-out

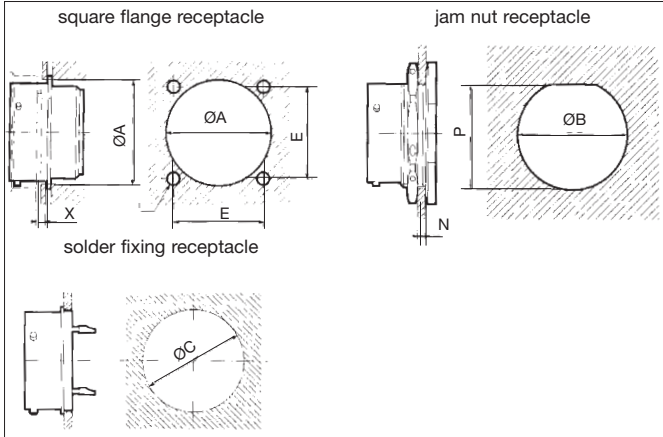

shell size	A	B	C	E	J	N		P	X min
						min	Max		
08	15.55 .612	14.60 .575	14.70 .579	15.10 .594	3.15 .124	1.57 .062	3.17 .125	13.75 .541	2.90 .114
10	18.80 .740	17.75 .699	17.50 .689	18.26 .719	3.15 .124	1.57 .062	3.17 .125	16.95 .667	2.90 .114
12	22.15 .872	22.50 .886	20.20 .795	20.62 .812	3.15 .124	1.57 .062	3.17 .125	21.50 .846	2.90 .114
14	25.30 .996	25.70 1.012	23.40 .921	23.00 .906	3.15 .124	1.57 .062	3.17 .125	24.20 .953	2.90 .114
16	28.45 1.120	28.85 1.136	26.60 1.047	24.60 .969	3.15 .124	1.57 .062	3.17 .125	27.35 1.077	2.90 .114
18	31.65 1.246	32.05 1.262	29.80 1.173	26.97 1.062	3.15 .124	1.57 .062	3.17 .125	30.55 1.203	2.90 .114
20	34.80 1.370	35.20 1.386	32.10 1.264	29.36 1.156	3.15 .124	1.57 .062	6.35 .250	33.70 1.327	5.50 .217
22	38.00 1.496	38.40 1.512	35.30 1.390	31.75 1.250	3.15 .124	1.57 .062	6.35 .250	36.90 1.453	5.50 .217
24	41.20 1.622	41.55 1.636	38.40 1.512	34.92 1.375	3.73 .147	1.57 .062	6.35 .250	40.05 1.577	5.50 .217

Accessories

Dummy receptacle

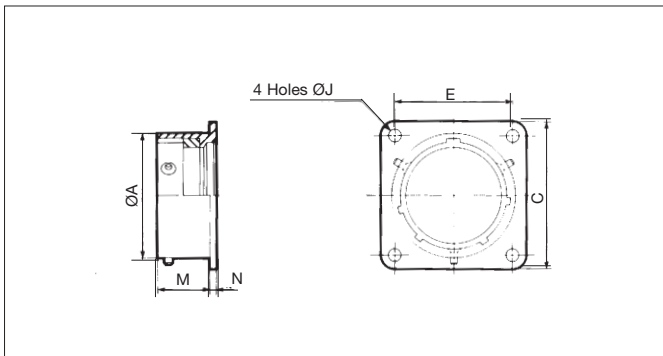

Shell size	A	C Max	E	J	M Max	N Max
08	12.03 .474	20.99 .826	15.09 .594	3.13 .123	11.70 .461	1.32 .052
10	15.01 .591	24.19 .952	18.26 .719	3.13 .123	11.70 .461	1.32 .052
12	19.07 .751	26.54 1.045	20.62 .812	3.13 .123	11.70 .461	1.32 .052
14	22.25 .876	28.89 1.137	23.00 .906	3.13 .123	11.70 .461	1.32 .052
16	25.42 1.001	31.29 1.232	24.61 .969	3.13 .123	11.70 .461	1.32 .052
18	28.60 1.126	33.69 1.326	26.97 1.062	3.13 .123	11.70 .461	1.32 .052
20	31.77 1.251	36.89 1.452	29.36 1.156	3.13 .123	14.35 .565	2.15 .085
22	34.95 1.376	39.99 1.574	31.75 1.250	3.13 .123	14.35 .565	2.15 .085
24	38.12 1.501	43.15 1.699	34.92 1.375	3.81 .150	15.20 .598	2.15 .085

Plastic protective caps for receptacle and plug

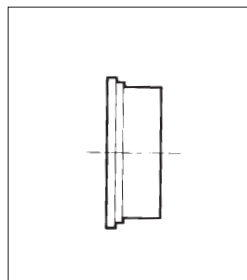

Shell size	caps for receptacle	caps for plug
08	8500-5585A	8500-5594
10	8500-5586A	8500-5595
12	8500-5587A	8500-5596
14	8500-5588A	8500-5597
16	8500-5589A	8500-5598
18	8500-5590A	8500-5599
20	8500-5591A	8500-5600
22	8500-5592A	8500-5601
24	8500-5593A	8500-5602

Gaskets

Shell size	gaskets for square flange receptacle		gaskets for jam nut receptacle	
	neoprene	fairprene	neoprene	viton (for hermetic receptacle)
8	8500-275	8500-4164	3330102	3330675
10	8500-276	8500-4165	3330103	3330670
12	8500-277	8500-4166	3330104	3330671
14	8500-278	8500-4167	3330105	3330672
16	8500-283	8500-4168	3330106	3331048
18	8500-279	8500-4169	3330107	3331049
20	8500-280	8500-4170	3330108	3331050
22	8500-281	8500-4171	3330109	3331051
24	8500-282	8500-4172	3330110	3331052

Re-usable fixing plate

Two, three or four-holes self-locking fixing-plates are available at SHTP. See page 126.

851 Series



Male - female square flange through bulkhead receptacle

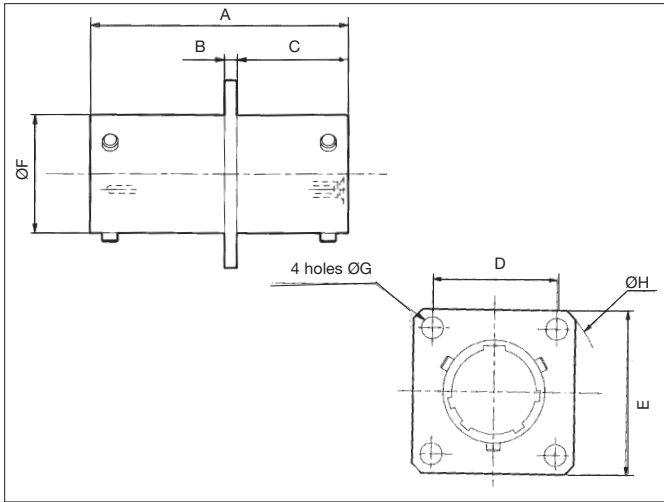

shell size	A	B	C	D	E	F	G	H
08	33.20 1.307	1.60 .063	14.30 .563	15.10 .594	20.60 .811	12.00 .472	3.20 .126	27.30 1.075
10	33.20 1.307	1.60 .063	14.30 .563	18.30 .720	23.80 .937	15.00 .591	3.20 .126	31.80 1.252
12	33.20 1.307	1.60 .063	14.30 .563	20.60 .811	26.20 1.031	19.05 .750	3.20 .126	35.10 1.382
14	33.20 1.307	1.60 .063	14.30 .563	23.00 .906	28.60 1.126	22.23 .875	3.20 .126	38.50 1.516
16	33.20 1.307	1.60 .063	14.30 .563	24.60 .969	30.90 1.217	25.40 1.000	3.20 .126	41.30 1.626
18	33.20 1.307	1.60 .063	14.30 .563	27.00 1.063	33.30 1.311	28.60 1.126	3.20 .126	44.70 1.760
20	36.40 1.433	2.40 .094	17.50 .689	29.40 1.157	36.50 1.437	31.75 1.250	3.20 .126	49.10 1.933
21	36.40 1.433	2.40 .094	17.50 .689	30.60 1.205	38.50 1.516	33.85 1.333	3.20 .126	51.20 2.016
22	36.40 1.433	2.40 .094	17.50 .689	31.80 1.252	39.70 1.563	34.90 1.374	3.20 .126	53.10 2.091
24	36.40 1.433	2.40 .094	17.50 .689	34.90 1.374	42.90 1.689	38.10 1.500	4.20 .165	57.30 2.256

Part numbers

basic series	EC 52 B	**	**	PS	*
shell size	851 range				
contact layout	please consult us				
contact type	P - male S - female				
polarization	N, W, X, Y, Z				

Jam nut receptacle with front release straight spills

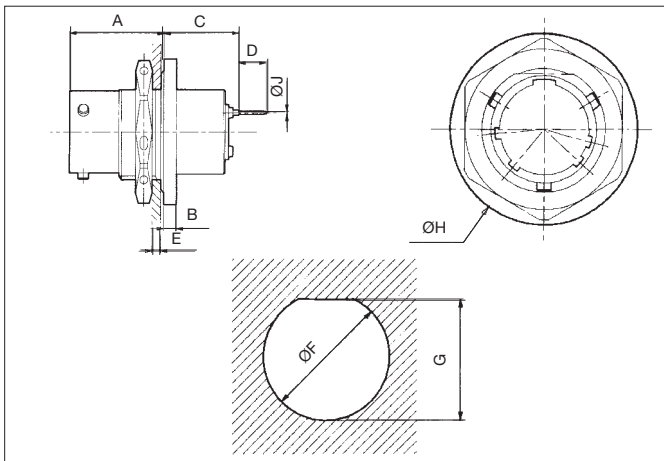

shell size	A	B	C	D	E Max	E min	F	G	H	J
08	17.25 .679	2.30 .091	13.68 .539	5.00 .197	5.00 .197	1.57 .062	14.60 .575	23.15 .911	23.15 .911	.60 .024
10	17.25 .679	2.30 .091	13.68 .539	5.00 .197	5.00 .197	1.57 .062	17.70 .697	16.80 .661	26.45 1.041	.60 .024
12	17.25 .679	2.30 .091	13.68 .539	5.00 .197	5.00 .197	1.57 .062	22.70 .894	20.90 .823	31.20 1.228	.60 .024
14	17.25 .679	2.30 .091	13.68 .539	5.00 .197	5.00 .197	1.57 .062	25.70 1.012	24.10 .949	34.40 1.354	.60 .024
16	17.25 .679	2.30 .091	13.68 .539	5.00 .197	5.00 .197	1.57 .062	28.80 1.134	27.20 1.071	37.55 1.478	.60 .024
18	17.25 .679	2.30 .091	13.68 .539	5.00 .197	5.00 .197	1.57 .062	32.00 1.260	30.40 1.197	40.75 1.604	.60 0.24
20	18.85 .742	2.50 .098	13.79 .543	5.00 .197	6.60 .260	1.57 .062	35.20 1.386	33.60 1.323	45.50 1.791	.60 .024
22	18.85 .742	2.50 .098	13.79 .543	5.00 .197	6.60 .260	1.57 .062	38.40 1.512	36.80 1.449	48.70 1.917	.60 .024
24	18.85 .742	2.50 .098	13.79 .543	5.00 .197	5.90 .232	1.57 .062	41.50 1.634	39.90 1.571	51.85 2.041	.60 .024

Part numbers

basic series	851	07A	**	**	P	*	SN0378
shell type	07A - jam nut receptacle without backshell						
shell size	851 range						
contact layout	consult SHTP						
contact type	P - male						
polarization							
manufactures specifications							