

Linear Guides NH AN-BN

AN/BN sliders with light- (Z) or medium (H) preload are standard stock items with prompt delivery

AN: Normal length, high-square type slider with tap holes on top

BN: Long length, high-square type slider with tap holes on top

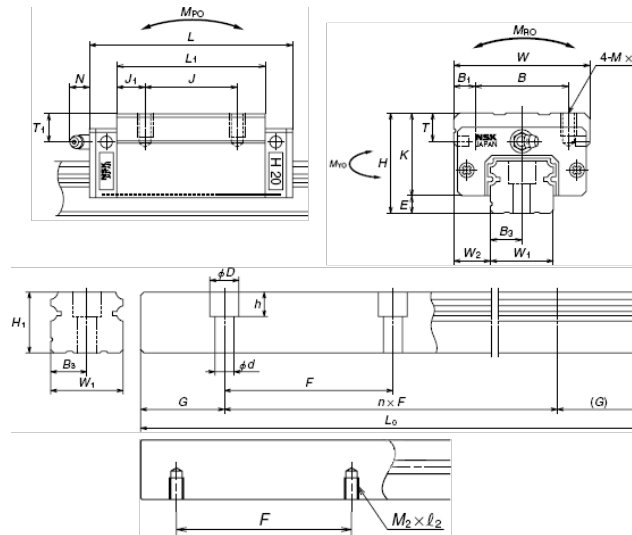

Model-No.

N1H201000LCNPCZ-20-20

Type

Linear Guide NH Series



Size	20
Slider type	AN
Number of sliders	1
Lubrication unit K1	No
Double seal	No
Metal protector	No
Material / Surface treatment	C
Length of rail	1000
Distance to first hole center (G1)	20
Distance to last hole center (G2)	20
Accuracy	PC
Preload	Z
H	-
E	-
W2	-
W	-
B	-
J	-

Created: 2014-12-05 13:17:42

Address:

NSK Europe Ltd
Harkortstrasse 15
D-40880 Ratingen
Germany

Phone:

Fax:

Web:

Email:

49 2102 481 0

49 2102 481 2881

<http://www.nskeurope.de>

info-de@nsk.com



L	-
L1	-
J1	-
K	-
T	-
M x l	-
Grease fitting	-
T1	-
N	-
Dynamic C (N)	-
Static C0 (N)	-
MRO (Nm)	-
MPO (Nm)	-
MYO (Nm)	-
Weight slider (kg)	-
W1	20
H1	18
F	60
dxDxh	6x9.5x8.5
M2xl2	M6 x 10
B3	10
G (recommended)	20
Weight rail (kg/m)	2.6