

Technology to Inspire Innovation

Preferred Connector Products

JAE

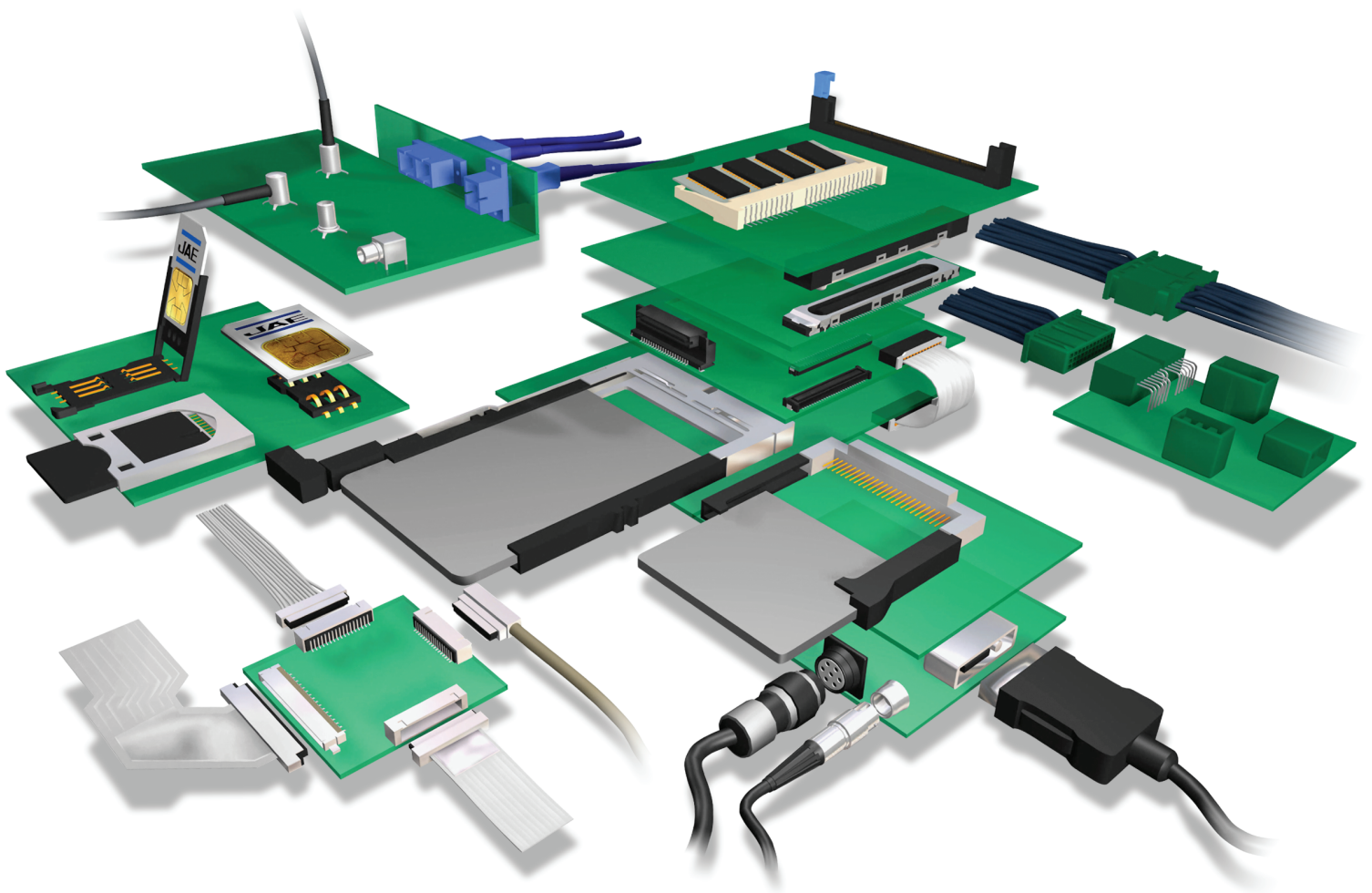

JAE Electronics, Inc.

For Additional Information Visit www.jae-connector.com

Japan Aviation Electronics Industry, Ltd. (JAE) is an international manufacturer and supplier of electronic components and systems. For over four decades, JAE has provided the electronics industry with solutions to complex design requirements. Since its founding, the Company has strived to contribute to society through market-driven, technology-based global business operations under the philosophy: "Technology to Inspire Innovation."

With worldwide and world-class manufacturing certified to ISO 9001 and QS 9000, JAE has made the commitment to meet the global requirements of our customer. In addition to a network of state of the art manufacturing facilities, JAE has technical service offices located around the world, staffed with experts in connector design and application.

This catalog contains a select overview of JAE Connector Products. For in-depth information on our complete product line, and information on new developments, visit JAE's online catalog at www.jae-connector.com.

Innovative design, quality oriented manufacturing, commitment to our customers and sensitivity to the environment assures JAE's leadership position in the 21st century.

Table of Contents

Product Series	Contact Spacing	Pages
SOCKETS/MEMORY PRODUCTS		
PCMCIA		
JC21EJ2	1.27mm (.050")	5
JC22	1.27mm (.050")	6
COMPACT FLASH		
JC26C2	1.27mm (.050")	7 - 8
JC26E	1.27mm (.050")	9
JC26F	1.27mm (.050")	10
PCI EXPRESS MINI CARD		
MM60	0.8mm (.031")	11
EXPRESSCARD		
PX10/11	1.0mm (.039")	12 - 13
PX20/22	1.0mm (.039") / 0.635mm (.025")	14 - 15
SMART/SIM CARD		
SF2	2.54mm (.100")	16
SF3	2.54mm (.100")	17
SF6	2.54mm (.100")	18
SF7	2.54mm (.100")	19
SF7 (Slim)	2.54mm (.100")	20
SF9	2.54mm (.100")	21
SECURE DIGITAL CARD		
SG5	2.50mm (.098")	22
MINI SECURE DIGITAL CARD (SD)		
ST4	1.1mm (.043")	23
SC2	1.3mm (.050")	24
SC1	2.50mm (.098")	25
MICRO SD/TRANSFLASH™		
ST1	1.1mm (.043")	26
ST2	1.1mm (.043")	27
BOARD-TO-BOARD CONNECTOR PRODUCTS		
BOARD-TO-BOARD		
AA03	0.40mm (.020")	28
WA6	0.40mm (.020")	29
WH1	0.40mm (.020")	30
AA01A	0.50mm (.020")	31
IL-312	0.50mm (.020")	32
WR	0.50mm (.020")	33 - 34
WB3	0.50mm (.020")	35
IL-WX	0.80mm (.031")	36
KX14/15	0.80mm (.031")	37 - 38
PM1	0.80mm (.031")	39
WM1	1.00mm (.039")	40
WM2	1.00mm (.039")	41
TX24/TX25	1.27mm (.050")	42

Table of Contents

Product Series	Contact Spacing	Pages
BOARD-TO-BOARD CONNECTOR PRODUCTS		
WIRE-TO-BOARD		
PCB-TO-FPC/FFC		
FB3.....	0.30mm (.012").....	43
FB5.....	0.30mm (.012").....	44
FB6.....	0.30mm (.012").....	45
FF02.....	0.30mm (.012").....	46
FF02S.....	0.30mm (.012").....	47
FB8.....	0.30mm (.012").....	48
FA5.....	0.50mm (.020").....	49
FF01.....	0.50mm (.020").....	50
FF03.....	0.50mm (.020").....	51
IL-FPR.....	0.50mm (.020").....	52
PCB-TO-CABLE/FPC		
FI-J.....	0.40mm (.016").....	53 - 54
FI-R.....	0.50mm (.020").....	55 - 56
FI-X.....	1.00mm (.039").....	57 - 58
FI.....	1.25mm (.049").....	59 - 61
PCB-TO-CABLE		
DX2/3.....	0.80mm (.031").....	62
FI-E.....	1.00mm (.039").....	63 - 64
CN10.....		65 - 66
CV10.....		67
IL-Z.....	1.25mm (.049").....	68 - 69
IL-S.....	2.00mm (.079").....	70 - 71
LY.....	2.00mm (.079").....	72
KD10.....	2.00mm (.079").....	73
IL-G.....	2.50mm (.098").....	74
INPUT/OUTPUT CONNECTOR PRODUCTS		
PCB-TO-PCB		
TX20.....	1.27mm (.050").....	75 - 76
PCB-TO-CABLE		
DD1.....	0.50mm (.020").....	77 - 78
DD2.....	0.50mm (.020").....	79 - 80
DG1.....	0.50mm (.020").....	81
RA1.....	0.50mm (.020").....	82
RC1.....	0.50mm (.020").....	83
DA1.....	0.60mm (.024").....	84
DE1.....	1.27mm (.050").....	85
TX20A.....	1.27mm (.050").....	86
DV2.....	1.905mm (.075").....	87 - 89
CIRCULAR		
JN1.....		90 - 91
JN2.....		92 - 93
JB5.....		94

Table of Contents

<i>Product Series</i>	<i>Contact Spacing</i>	<i>Pages</i>
 INPUT/OUTPUT CONNECTOR PRODUCTS		
CIRCULAR		
JL04V		95 - 96
JL05		97 - 98
JB1		99 - 100
SRCN		101 - 102
N/MS		103 - 104
 FIBER OPTIC PRODUCTS		
FO-FC		105
FO-EX		106
 AUTOMOTIVE CONNECTOR PRODUCTS		
PCB-TO-CABLE		
MX34	1.1mm (.043")	107
MX7	2.30mm (.091")	108
IL-AG7	2.50mm (.098")	109
MX17	2.50mm (.098")	110 - 111
MX23A	2.50mm (.098")	112 - 113
MX10	2.50mm (.098")	114
MX5	3.00mm (.118")	115
 PCB-TO-CABLE/CABLE-TO-CABLE		
IL-AG5	2.50mm (.098")	116
IL-AG6	2.50mm (.098")	117
MX9	3.50mm (.138")	118
MX25	6.7mm (2.64")	119
MX36	2.50mm (.098")	120
 CABLE-TO-CABLE		
IL-AG9	2.50mm (.098")	121 - 123
MX19	2.50mm (.098")	124

- All JAE connector products shown in this catalog are lead free.
- We reserve the right to modify designs in order to improve quality, keep pace with technological advancements or meet particular requirements in production.
- Products shown in this catalog are made for the applications specified. However, if the above-mentioned products are to be used in aerospace devices, marine cable-connection devices, atomic power control systems, medical equipment for life-support systems, or any other specific application requiring extremely high reliability, please contact JAE for further information. Recommended Applications: Computers, Office Machines, Measuring Devices, Telecommunications Devices (Terminals, Mobile Devices) AV Devices, Household Applications, FA Devices, etc.
- Refer to end of catalog for alphabetical index of products.

AA03 SERIES CONNECTORS

0.40mm (.016") Contact Spacing, PCB to PCB SMT Connectors

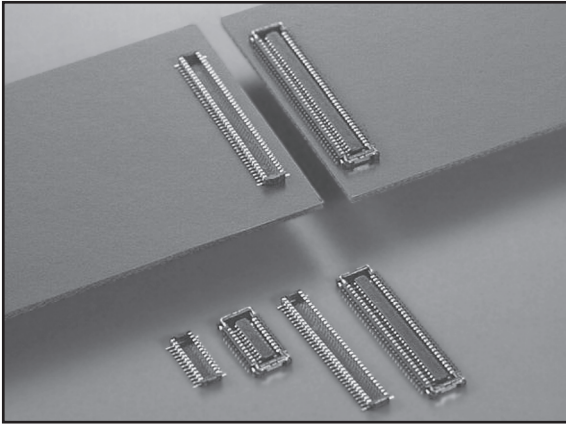

FEATURES

- 0.4mm (.016") contact spacing; double row; 22 to 80 positions; stacking height: 1.0mm (.039")
- High abrasion resistant contact structure provides increased contact reliability
- Secure hold-down prevents insulator breakage or lift-off from FPC (receptacle side)
- Separate 2-point contact design resists twisting stress
- Lead-free and nickel barrier in contact prevents solder migration
- Connectors for both inspection jigs are provided for both plug and receptacle
- Standard products (3,000 pieces/reel) and inspection jig products (300 pieces/reel) supplied on emboss tape

Connector Profile (Ref.)

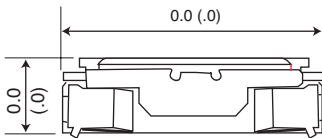

The AA03 Series connectors have 0.40mm (.016") pitch, and 1.0mm (.039") height board-to-board connection that is ideal for slim, low-profiled information communication devices such as mobile phones, LCDs and PDAs, with high density mounting requirements.

GENERAL SPECIFICATIONS

Number of Contacts	22, 30, 36, 40, 50, 64, 80 pos.
Contact Spacing	0.40mm (.016")
Contact Resistance	70 milliohms (initial)
Dielectric Withstanding Voltage	250 VAC r.m.s. (for one minute)
Insulation Resistance	100 megohms min. (initial)
Rated Current	AC, DC 0.4A (per pin)
Operating Temperature	-40°C to +85°C
Contact Life Durability	50 cycles min.
Rated Voltage	AC, DC 50V
Pitch	0.4mm (.016"), 2 rows
Total Insertion Force	1N x n max. (n: pos.)
Total Withdrawal Force	0.15N x n min. (n: pos.)

MATERIALS AND FINISHES

•Base Side

Components	Materials/Finishes
Insulator	Heat Resistant Plastic (UL94V-0, Black)
Contact	Copper Alloy Contact Area: Gold Plating (0.1µm min.)
Hold-down	Plug: Copper Alloy/ Gold plating (0.1µm min.) Receptacle: Copper Alloy/Tin type plating

ORDERING INFORMATION

Series	AA03	*	***	V	A	*	R***
Contact Shape							
P – Plug Side							
S – Receptacle Side							
No. of Contacts							
022 – 22 position							
030 – 30 position							
036 – 36 position							
040 – 40 position							
050 – 50 position							
064 – 64 position							
080 – 80 position							
Connection Type							
V – Stacking Type							
Finish							
A – Gold Plating							
Modify Code							
None – Without shield plate							
1 – Standard Product							
E – For Inspection Jig.							
Reel Product No.							
R6000 – Standard Product							
R300 – For Inspection Jig.							

Dimensions and specifications subject to change without notice.

WA6 SERIES CONNECTORS

0.40mm (.016") Contact Spacing, PCB to PCB SMT Connectors

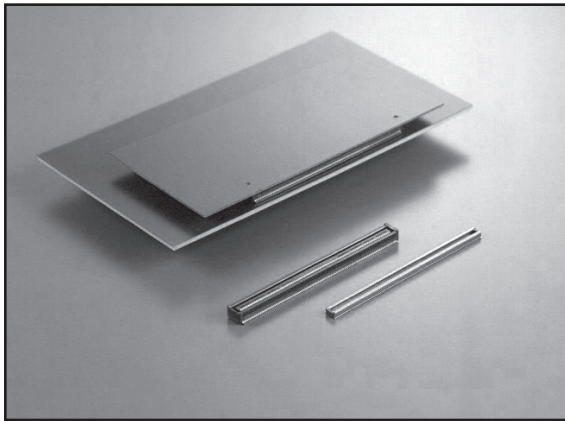

FEATURES

- Low profile, with parallel board stacking height of 3mm (0.12")
- 214 contacts
- Less than 0.1mm (0.004") coplanarity of terminal portion
- Solder reinforcement contacts provided in each corner of connector (2 contacts X 4 corners-- total 8 contacts)
- 0.6mm (0.024") contact wiping length
- Integrated molding technology of contact and resin mold (plug) prevents solder wicking
- Compatible with automatic mounting
- Available with Kapton tape or embossed tape
- Available with or without positioning boss
- No polarization characteristics

ORDERING INFORMATION

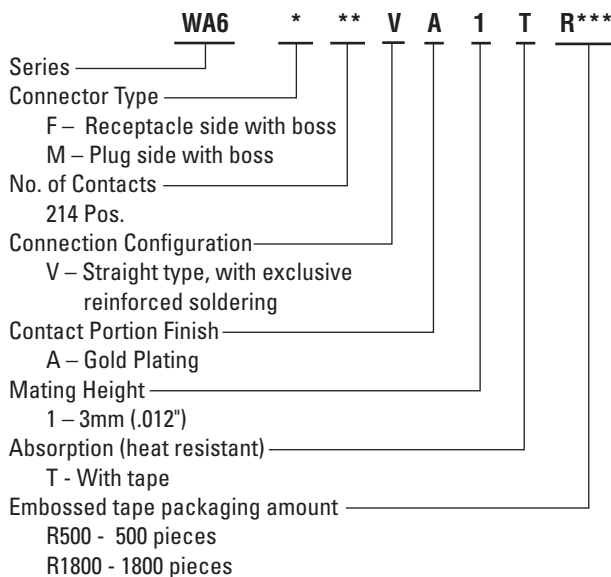

Dimensions in mm (inches).



The WA6 Series connectors are high-pin count, low-profile board-to-board connectors with excellent board warpage prevention. They are specified as the JEDEC standard for 214-pin DDR2 Micro-DIMM modules. In addition to DDR2, applications include high-density, multi-pole interconnections in PCs and TVs.

GENERAL SPECIFICATIONS

Number of Contacts	214 pos.
Contact Spacing	0.40mm(.016")
Contact Resistance	70 milliohms (initial)
Dielectric Withstanding Voltage	500VAC r.m.s. (for one minute)
Rated Current	AC, DC each 0.3A/per pin
Rated Voltage	200VAC
Insulation Resistance	100 megohms min. (initial)
Contact Pitch	0.4mm (0.16")

MATERIALS AND FINISHES

• Receptacle Side

Components	Materials/Finishes
Contact	Copper Alloy Contact Area: Gold Terminal Area: Gold flash
Reinforced Soldering Contacts	Copper Alloy/ Gold plating Terminal area: Gold flash
Insulator	Heat resistant plastic/ none
Heat Resistant Tape	Polyimide /none

• Plug Side

Contact	Copper Alloy Contact Area: Gold Terminal Area: Gold flash
Reinforced Soldering Contacts	Copper Alloy/ Gold plating Terminal area: Gold flash
Insulator	Heat resistant plastic/ none
Heat Resistant Tape	Polyimide /none

Connector Profile (Ref.)

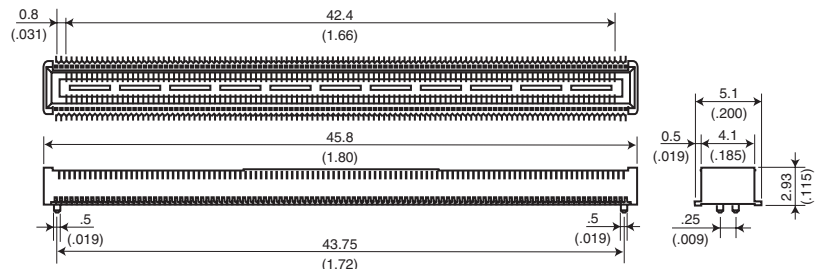

WH1 SERIES CONNECTORS

0.40mm (.016") Contact Spacing, PCB to PCB SMT Connectors

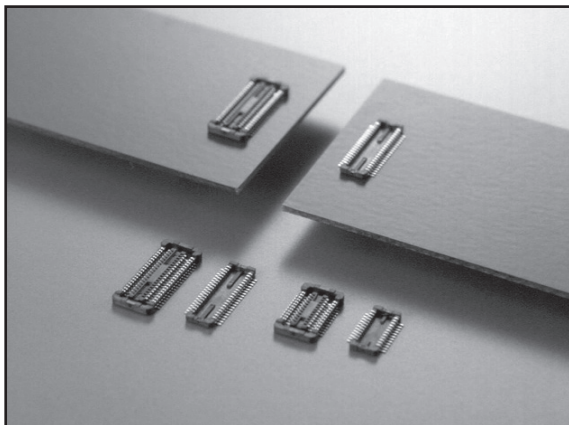

FEATURES

- 0.40mm (0.016") pitch, double lines, 25 and 40 pos
- Contacts have high abrasion resistance
- Roll contacts assure contact reliability
- Simple locking structure provides "click" response
- Plug and receptacle feature solder migration countermeasure
- Lead-free



The WH1 Series is a low-cost, ultra-slim board-to-board connector with just a 1mm ((0.04") mated height. It is ideal for thin devices such as mobile phones, cameras, LCDs, and PDAs.

GENERAL SPECIFICATIONS

Number of Contacts	22, 24 pos.
Contact Spacing	0.40mm (.016")
Contact Resistance	70 milliohms max. (initial)
Dielectric Withstanding Voltage	250 VAC r.m.s. (for one minute)
Insulation Resistance	100 megohms min. (initial)
Rated Current	AC, DC 0.4A (per pos)
Operating Temperature	-40°C to +85°C
Lifetime	50 times
Rated Voltage	AC, DC 50V
Pitch	0.4mm (.016"), 2 rows
Total Insertion Force	1N x n max. (n: pos.)
Total Withdrawal Force	0.15N x n min. (n: pos.)

MATERIALS AND FINISHES

•Base Side

Components	Materials/Finishes
Insulator	Heat Resistant Plastic (UL94V-0, Black)
Contact	Copper Alloy/ Gold Plating (0.1µm min.)

Connector Profile (Ref.)

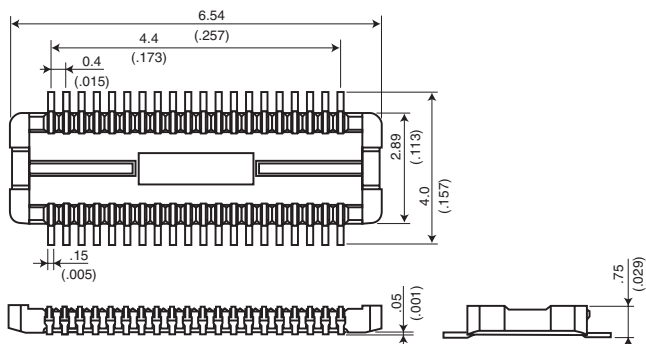

ORDERING INFORMATION

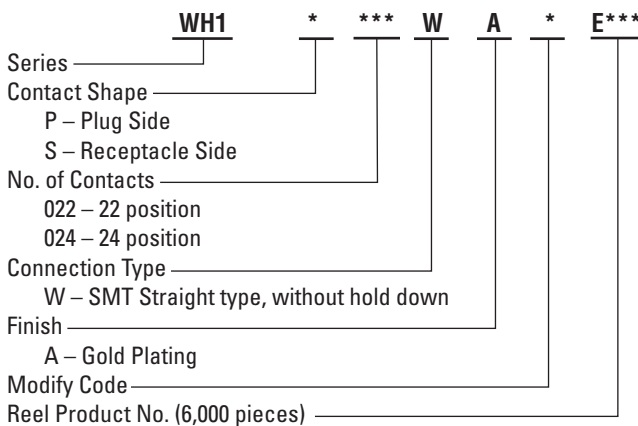

Dimensions and specifications subject to change without notice.

AA01A SERIES CONNECTORS

0.50mm (.020") Contact Spacing, PCB to PCB SMT Connectors

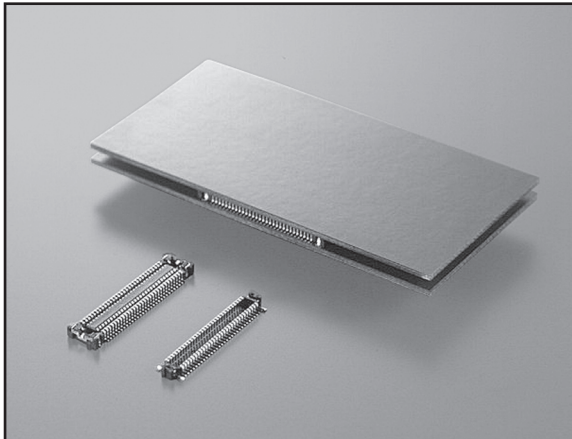

FEATURES

- 0.5mm (.020") pitch 2 row connector
- Low profile 1.5mm mating height
- Small space required on the board for mounting
- Guide on insulator mates connector automatically by assembly machine
- Large hold down for secure mounting
- Metal hold down covers corner and shorter side of connector to decrease contact stress
- Locking mechanism in each contact
- Unique design prevents solder wicking
- Each contact has two contact mating areas, for secure mating
- Anti-shock structure for drop testing
- Lead free

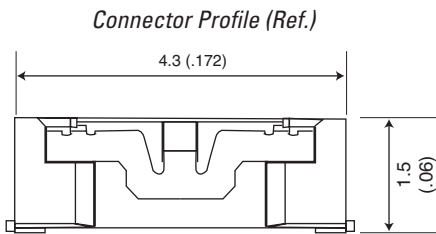

Dimensions in mm (inches).



The AA01A Series is a 0.5mm (.020") pitch, SMT, board-to-board connector with a 1.5mm (.059") stacking height. The fine pitch and low profile offer system designers a wide range of flexibility in order to meet the tight packaging requirements needed in applications such as PDAs, cell phones, camcorders, notebook PCs and other compact equipment.

GENERAL SPECIFICATIONS

Number of Contacts	10, 30, 40, 60
Contact Spacing	0.5mm (.020")
Current Rating	0.2 Amp per contact
Withstanding Voltage	250 VAC r.m.s. (for one minute)
Insulation Resistance	100 megohms min.
Contact Resistance	70 milliohms max.
Operating Temperature	-40°C to +85°C

MATERIALS AND FINISHES

Description	Materials/Finishes
Insulator	Heat Resistant Plastic (UL94V-0, Black)
Contact	Copper Alloy with Gold Plating Contact Area: 0.1 μm min.
Hold down	Copper Alloy with Tin Plating

ORDERING INFORMATION

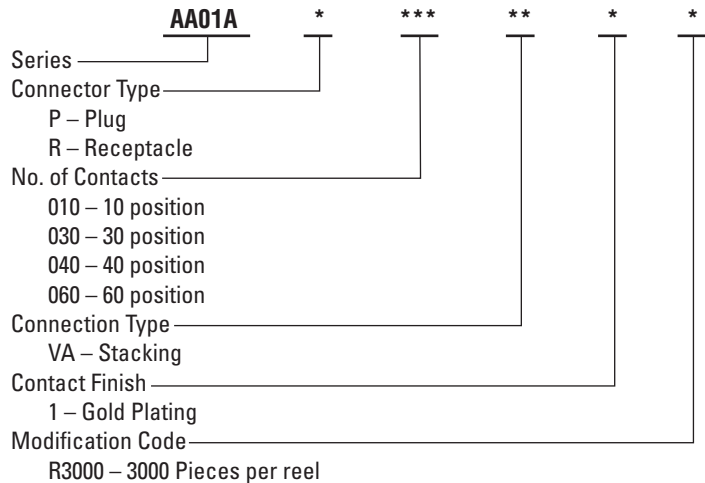

IL-312 SERIES CONNECTORS

0.50mm (.020") Contact Spacing, PCB-to-PCB SMT Connectors

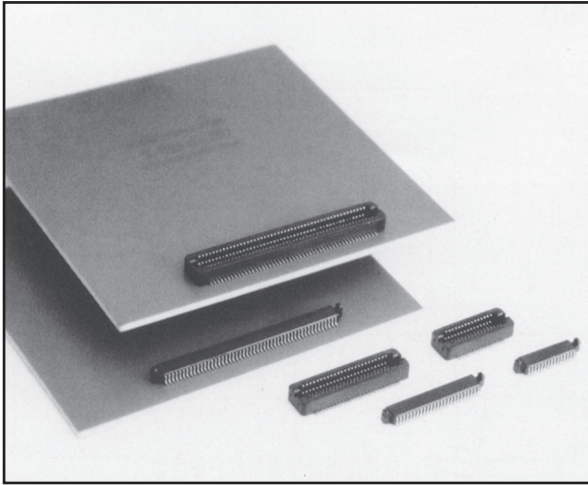

FEATURES

- SMT contacts
- 2.5mm (.098") to 3.5mm (.138") stacked height
- Surface area of both pin and socket connectors facilitates automatic mounting
- Contact terminal length permits image recognition
- Available on embossed tape for automatic mounting
- Lead free

Connector Profile (Ref.)

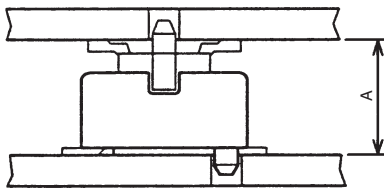

Stacking Height (A)

		Pin	
Connector height code		Blank (standard)	30
Socket	Blank (standard)	2.5 (.098)	3.0 (.118)
	H05	3.0 (.118)	3.5 (.138)

• • • • •

These high density SMT connectors are designed for parallel PCB-to-PCB applications. They are ideal for use in VCRs, notebook PCs, cordless telephones, mobile phones, audio/visual and other telecommunications equipment where reduced size and weight are important.

GENERAL SPECIFICATIONS

Number of Contacts	20, 30, 40, 50, 60, 70, 80
Contact Spacing	0.50mm (.020")
Current Rating	0.3 Amp per contact
Dielectric Withstanding Voltage	500 VAC r.m.s. (for one minute)
Insulation Resistance	100 megohms min.
Contact Resistance	40 milliohms max.
Operating Temperature	-40°C to +85°C

MATERIALS AND FINISHES

Description	Materials/Finishes
Insulator	Heat-resistant plastic (UL94V-0, Black)
Contact	Copper alloy/Gold Plating: connecting area 0.1µm (.000004") min.

ORDERING INFORMATION

	IL-312	-	**	*	*	VF	**	-	A1
Series									
No. of Contacts	20, 30, 40, 50, 60, 70, 80, 100								
Contact Type	P - Pin S - Socket								
Polarizing Boss	Blank - No Boss B - Positioning Boss								
Termination Style	VF - Straight								
Connector Height Code	[Socket] Blank (Standard) - 2.15 (.085) H05 - 2.65 (.104) [Pin] Blank (Standard) - 1.55 (.061) 30 - 2.05 (.081)								
Finish Code	A1 - Gold Plating, 0.1µm (.000004") min.								

Dimensions and specifications subject to change without notice.

WR SERIES CONNECTORS

0.50mm (.020") Contact Spacing, PCB-to-PCB SMT Connectors

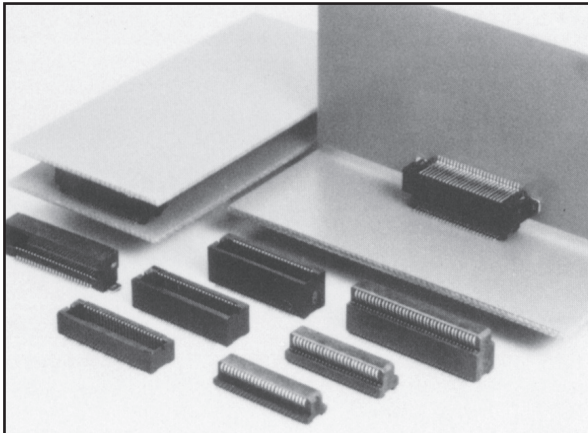

FEATURES

- Ribbon contact design (surface contact)
- Right Angle/Parallel Board-to-Board Connections
- Nine varieties 4 to 9mm (.157 to .354") of parallel board-to-board distance
- Three straight type insulator heights
- Metal hold-downs on both ends of right angle type prevent floating up during automatic mounting
- PCB area beneath insulator may be used for circuit traces
- Available in embossed tape for automatic SMT mounting
- Contact terminal length permits image recognition



The WR Series are SMT-type connectors for PCB-to-PCB applications. These subminiature, low profile connectors keep the required space and height on the PCB to a minimum. High density, ribbon-type contacts are on 0.5mm (.020") centers.

Applications include camcorders, notebook PCs, cellular telephones and other electronic equipment requiring high density packaging.

GENERAL SPECIFICATIONS

Number of Contacts	Straight: 20, 22, 28, 30, 40, 50, 60, 70, 80, 100, 120, 160 Right Angle: 20, 30, 40, 50, 60, 70, 80, 120
Contact Spacing	0.50mm (.020")
Current Rating	0.3 Amp per contact
Dielectric Withstanding Voltage	500 VAC r.m.s. (for one minute)
Insulation Resistance	100 megohms min.
Contact Resistance	50 milliohms max. (Vertical: 70 milliohms max.)

MATERIALS AND FINISHES

Description	Materials/Finishes
Insulator	Socket side: Glass-filled LCP (UL94V-0, Black) Pin side: Glass-filled PPS (UL94V-0, Black)
Contact	Copper Alloy Connecting area: Gold Plating 0.1µm (.000004") min. over Nickel Terminal area: Tin Plating over Nickel or Gold flash over Nickel
Hold-down	Copper Alloy/Tin Plating

ORDERING INFORMATION

	WR	-	**	S	*	-VF	H05	-	N1
Series									
No. of Contacts	30, 40, 50, 60, 70, 80, 120								
Contact Type	S - Socket								
Polarizing Boss	Blank - No Boss B - Boss								
Termination Style	VF - Straight								
Connector Height	No Letter (standard): 3.25mm (.128") H05: 3.75mm (.148") H30: 6.25mm (.246")								
Contact Finish	N1 - Lead Free								

WR SERIES CONNECTORS

0.50mm (.020") Contact Spacing, PCB-to-PCB SMT Connectors

Connector Profile (Ref.)

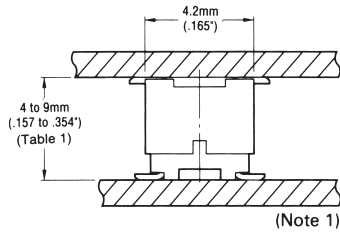

PIN SIDE
Straight • Standard Type
WR-**-P-VF-N1

Straight • 50 Type
WR-**-P-VF50-N1

Straight • 60 Type
WR-**-P-VF60-N1

SOCKET SIDE
Straight • Standard Type
WR-**-S-VF-N1

Straight • H05 Type
WR-**-S-VFH05-N1

Straight • H30 Type
WR-**-S-VFH30-N1

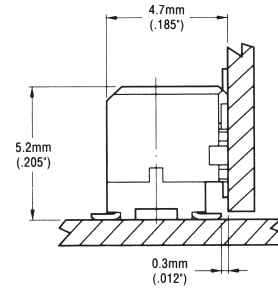

PIN SIDE
Right Angle Type
WR-**-P-HF-HD-A1E

SOCKET SIDE
Straight • H05 Type
WR-**-S-VFH05-N1

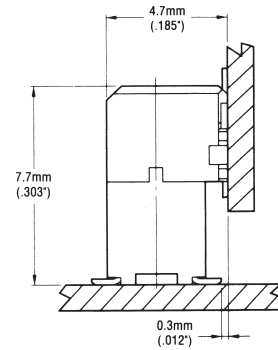

PIN SIDE
Right Angle Type
WR-**-P-HF-HD-A1E

SOCKET SIDE
Straight • H30 Type
WR-**-S-VFH30-N1

Note 1: 3 connector heights are available for straight type.
Parallel board-to-board distance can be selected in a range from 4mm (.157") to 9mm (.354") [9 kinds].

Table 1

		SOCKET SIDE			
		Connector type	Standard type	H05 type	H30 type
PIN SIDE	Standard type	4.0mm (.157")	4.5mm (.177")	7.0mm (.276")	
	50 type	5.0mm (.197")	5.5mm (.217")	8.0mm (.315")	
	60 type	6.0mm (.236")	6.5mm (.256")	9.0mm (.354")	

WB3 SERIES CONNECTORS

0.50mm (.020") Contact Spacing, Board to Board Connector Compatible with PCI Express

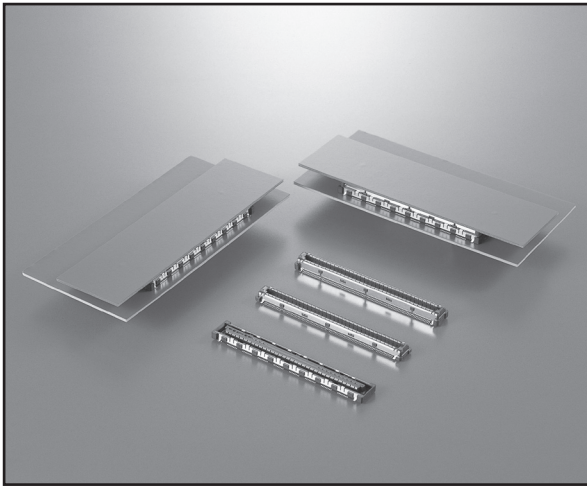

FEATURES

- Compliant with PCI Express Card Electrical Mechanical SPEC
- High density 0.5mm pitch type yet having a high level transmission characteristic and high speed transmission is possible.
- Contact configuration that enables transmission of PCI Express (X16), TMD5, VGA and others.
- Parallel board to board connection is possible. Stacking height, 4mm and 5mm are available.
- EMI shielding is applied.
- Compatible to automatic mounting. Available in embossed tape package.

Connector Profile (Ref.)

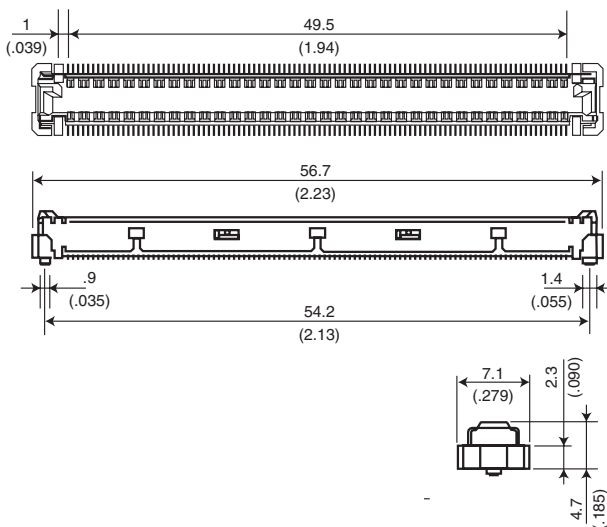

Dimensions in mm (inches).

.....

WB3 Series are board to board connectors satisfying the specification of the transmission characteristics specification of the PCI Express standard. Suitable for connections between units that need TMD5 transmission, such as graphic card and PCI Express.

GENERAL SPECIFICATIONS

Number of Contacts	20 pos
Contact Spacing	0.50mm (.020")
Contact Resistance	50 milliohms max.
Dielectric Withstanding Voltage	250VAC per minute
Operating Temperature	-40°C to +85°C
Rated Current	0.5A/per pin
Mating Cycle	25 cycle
Insertion loss	-1dB min. (1.25GHz max.) -5dB min. (3.75GHz max.)
Return loss	-12dB max. (1.3Ghz max.) -7dB max. (2Ghz max.) -4dB (3.75GHz max.)
Cross Talk (near end)	32dB max. (1.25Ghz max.) -26dB max. (3.75GHz max.)

MATERIALS AND FINISHES

• Receptable

Description	Materials/Finishes
Contact	Copper Alloy/ Contact: 0.76um min. Gold plating over Nickel Terminal: Gold flash plating over Nickel
Insulator	Thermoplastic resin UL94V-0 black
Shell	Copper alloy: Tin plating

• Plug

Contact	Copper Alloy/ Contact: 0.76um min. Gold plating over Nickel Terminal: Gold flash plating over Nickel
Insulator	Thermoplastic resin UL94V-0 black
Shell	Stainless steel: Tin plating

ORDERING INFORMATION

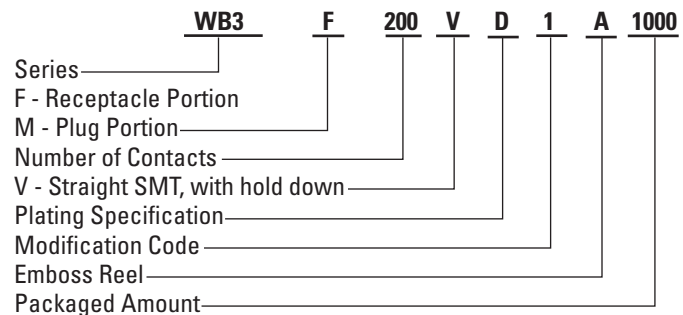

IL-WX SERIES CONNECTORS

0.80mm (.031") Contact Spacing, PCB-to-PCB SMT Connectors

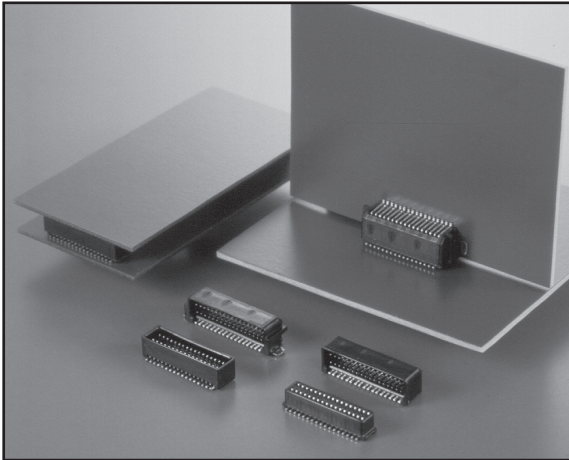

FEATURES

- Low profile, connection between parallel boards spaced 4.5 mm
- Combinations of socket receptacle (straight) and pin header (straight/right angle) enable vertical and parallel connections
- The boss on both sides of connector bottom ensure correct positioning on board
- Configuration suited for automatic packaging



IL-WX Series connectors are designed for board-to-board applications. Designed with extremely small spacing, centers are on 0.8mm (.031") with double row contact arrangement. The connector features SMT contact configuration for automatic mounting. It is intended for use in portable appliances where size reduction is important. Applications include video camera and OA equipment.

GENERAL SPECIFICATIONS

Number of Contacts	6 to 36 (even numbers only)
Contact Spacing	0.80mm (.031"), double row
Current Rating	0.5 Amps
Dielectric Withstanding Voltage	500 VAC r.m.s. (for one minute)
Insulation Resistance	100 megohms min.
Contact Resistance	25 milliohms max.
Operating Temperature	-40°C to +85°C

MATERIALS AND FINISHES

Description	Materials/Finishes
Insulator	Glass filled PPS (UL94V-0, Black)
Pin Contact	Copper Alloy/Tin Plating
Socket Contact	Phosphor Bronze /Tin plating
Hold Down	Phosphor Bronze /Tin plating

ORDERING INFORMATION

IL-WX - 10 S - VF - B
 IL-WX - 10 P B - HF - HD - S - B - E1000 E

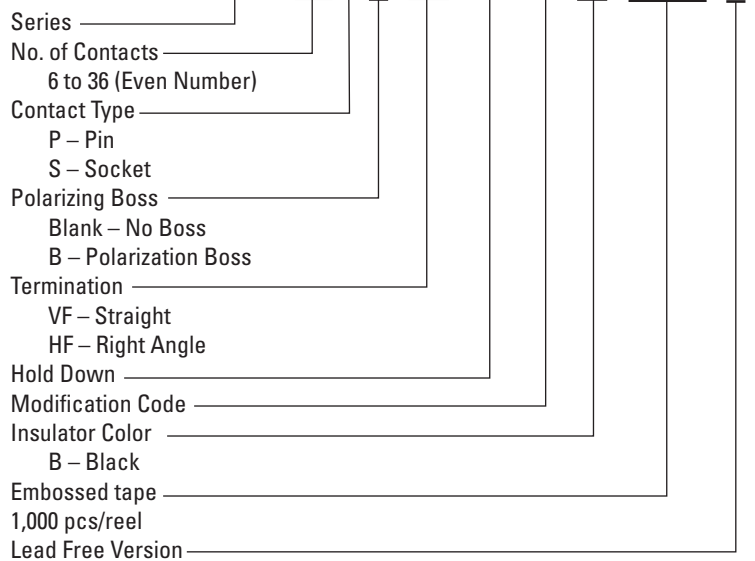

Connector Profile (Ref.)

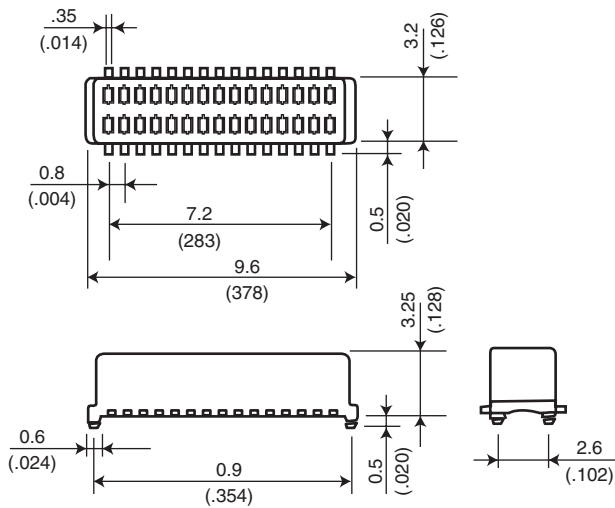

Dimensions and specifications subject to change without notice.

KX14/15 SERIES CONNECTORS

0.80mm (.031") Contact Spacing, PCB-to-PCB SMT Connectors

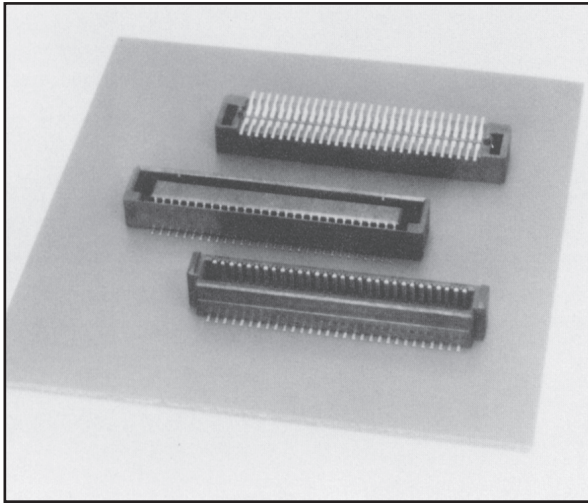

FEATURES

- 0.80mm (.031") contact spacing
- Straight receptacle (KX14) and right angle/straight plug (KX15) for parallel and vertical PCB connections
- 4 to 18mm (.157 to .709") stacking heights
- Polarization key prevents mismatching
- Resistant to vibration and twisting
- Available in embossed tape for automatic mounting

Connector Profile (Ref.)

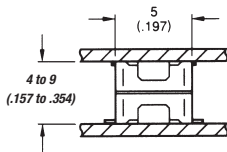

Hold-down type (Right-angle side)

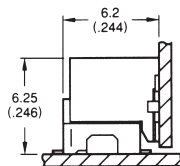

Screw type (Right-angle side)

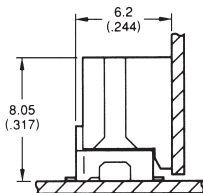

Dimensions in mm (inches).



The KX14/15 Series connectors are low profile, SMT type connectors for PCB-to-PCB applications. Contact spacing is 0.8mm (.031"). The receptacle (KX14) and plug (KX15) combination offer variable stacking heights of 4 to 9mm (.157 to .354").

These connectors are ideal for use in the personal computer industry where space, weight and high density are critical factors.

GENERAL SPECIFICATIONS

Number of Contacts	Straight: 20, 30, 40, 50, 60, 70, 80, 100, 120, 140, 160 Right Angle: 20, 30, 40, 50, 60, 70, 80, 140
Contact Spacing	0.80mm (.031") Double Row
Current Rating	0.5 Amp per contact
Dielectric Withstanding Voltage	500 VAC r.m.s. (for one minute)
Insulation Resistance	100 megohms min.
Contact Resistance	70 milliohms max.
Operating Temperature	-40°C to +85°C
Voltage Rating	AC 200V, DC 300V

Note 1: Please consult JAE for availability

MATERIALS AND FINISHES

Description	Materials/Finishes
Insulator	
KX14	Glass-filled LCP (UL94V-O Black)
KX15 Straight	Glass-filled PPS (UL94V-O Black)
KX15 Right Angle	Glass-filled LCP (UL94V-O Black)
Contact	Copper Alloy Connecting Area: 0.1µm (.000004") min. Gold Plating Over Nickel Terminal Area: Gold flash over Nickel or Tin-Lead over Nickel
Hold Down	Copper Alloy/Tin-Lead over Nickel
Hook Pin	Copper Alloy/Tin plating
Hexagon Nut	Brass/Nickel plating

KX14/15 SERIES CONNECTORS

0.80mm (.031") Contact Spacing, PCB-to-PCB SMT Connectors

ORDERING INFORMATION

• Straight

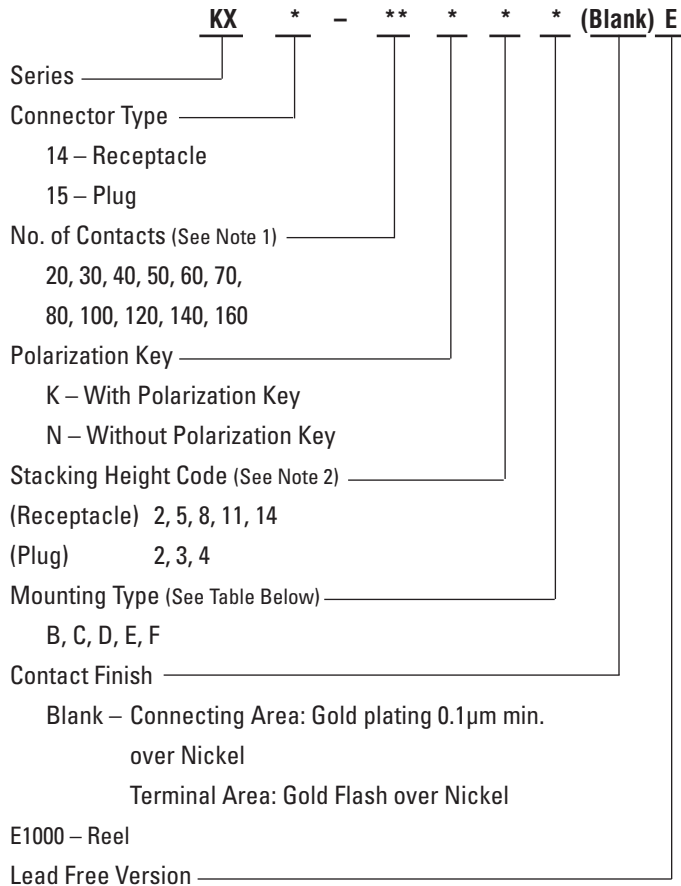

• Right Angle

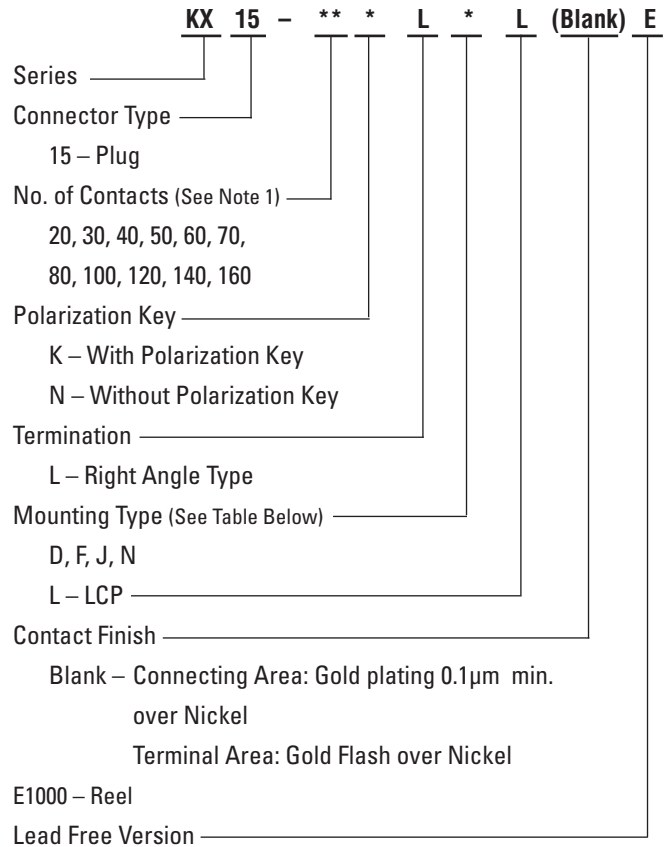

Note 1: Please consult JAE for availability.
 Note 2: Stacking Height = Stacking Height Code of KX14 &
 Stacking Height Code of KX15.

Mounting Type for Straight

	Positioning Key	Hold Down	Flange	Hook Pin
B	○	–	–	–
C	○	–	○	○
D	○	○	○	–
E	○	–	○	–
F	–	○	○	–

Note 1: Please consult JAE for availability.

Mounting Type for Right Angle

	Positioning Key	Hold Down	Nut
D	○	○	–
F	–	○	–
J	○	–	–
N	○	–	○

Stacking Height (Parallel PCB to PCB connection)

	Plug			
	Stacking Height Code	2	3	4
Receptacle	2	4 (.157)	5 (.197)	6 (.236)
	5	7 (.276)	8 (.315)	9 (.354)
	8	10 (.394)	11 (.433)	12 (.472)
	11	13 (.512)	14 (.551)	15 (.591)
	14	16 (.630)	17 (.669)	18 (.709)

Dimensions and specifications subject to change without notice.

PM1 SERIES CONNECTORS

0.80mm (0.031") Contact Spacing, PCB-to-PCB Bay Connectors

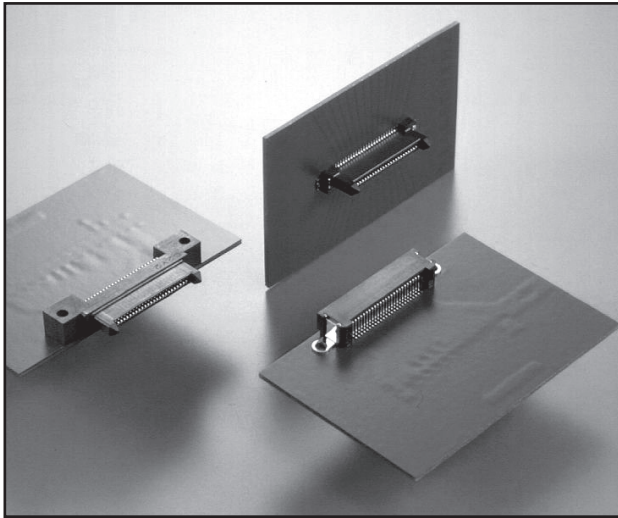

FEATURES

- 5.4mm (0.21") connector height, low profile board-to-board bay connector
- Plug side has two-step contact length insertion structure
- Two-step contact length insertion structure compatible with both 3.1mm (0.12") and 2.7mm (0.11") contact lengths
- Insertion guide absorbs displacement caused by insertion and removal from drive
- Lifetime of 7,000 insertions/removals
- Drive side plug can be mounted to board in common with KX15-50KLDP (no mating compatibility between PM1 Series and KX14/15 Series connectors)



The PM1 Series is a bay connector designed for 9.5mm (0.374") thick optical drives, such as those used in notebook computers. The series includes an SMT receptacle and either an SMT plug for right-angle connection or a through-hole plug for coplanar connection.

GENERAL SPECIFICATIONS

Number of Contacts	50 pos.
Contact Spacing	0.80mm (0.031")
Current Rating	0.5 Amp per contact
Dielectric Withstanding Voltage	250 VAC r.m.s. (for one minute)
Insulation Resistance	100 megohms min.
Contact Resistance	70 milliohms max.
Rated Voltage	125 VAC r.m.s.
Lifetime	7000 times

MATERIALS AND FINISHES

Description	Materials/Finishes
Base Insulator	LCP filled with heat-resistant plastic glass (UL94-V), Black
Contact	Contact Area: Gold Plating Terminal Area: Tin plating over Nickel
Reinforcement	Copper Alloy/ Tin type plating

ORDERING INFORMATION

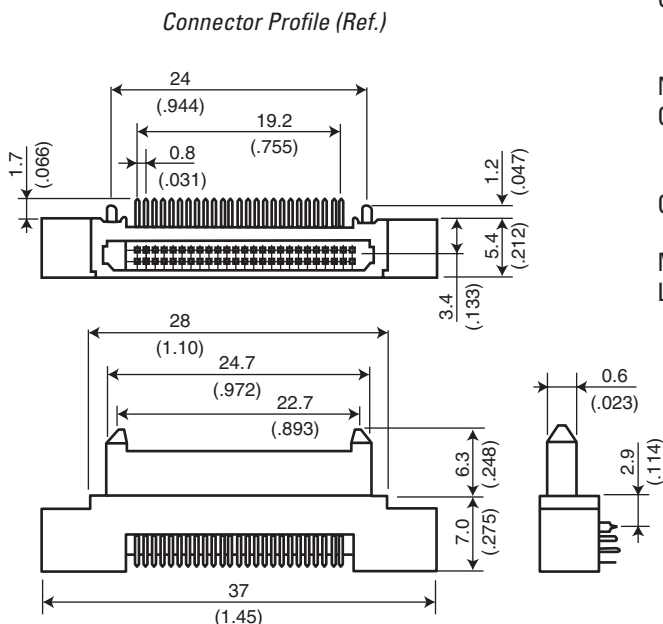
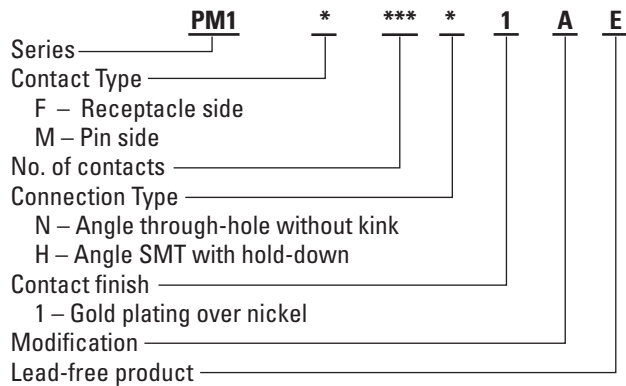

Dimensions in mm (inches).

WM1 SERIES CONNECTORS

1.00mm (0.039") Contact Spacing, PCB-to-PCB Bay Connectors

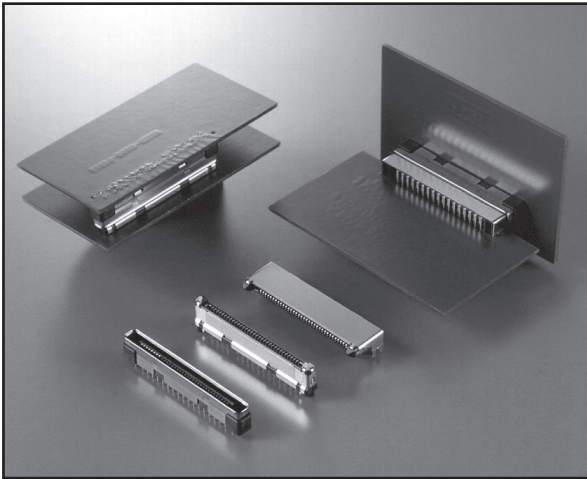

FEATURES

- Bay connectors with 1.0mm (.039") pitch and 68 contacts support USB 2.0 in addition to IDE for signal
- Metal shell used for EMI prevention
- A 5.55mm (.218") connector height realizes a low profiled board-to-board bay connector
- Supports hot plug by using a 2-level hot plug structure on plug side (WM1M068U1A). Two types of valid connection lengths, 2.9mm (.114") and 2.5mm (.098"), for contacts to support 2 levels of hot plug (difference in level 0.4mm (.016"))
- Plug side of WM1M068U1A and receptacle side of WM1F068U1A both equip positioning bosses to support through hole reflow
- 12.8mm (.504") mating depth
- Plug side of WM1M068U1A supports Interposer boards (SLB-XDE-1, -TMK-1)
- Superior positioning error absorption structure. Insertion guide is used to absorb errors during drive insertion and removal.
Width: ± 2.0 mm, height: ± 2.0 mm
- Lifetime: 50,000 times
- Products available with 1.0 μ m and 0.76 μ m Gold Plating thicknesses on connection area of contacts ensuring high reliability
- Key prevents mis-mating

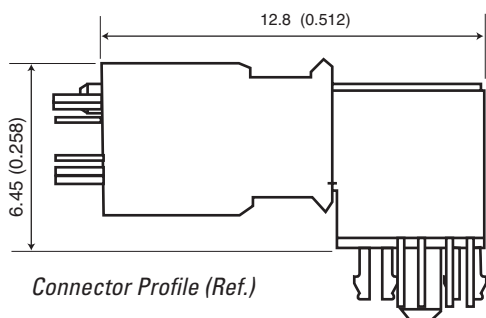

The WM1 Series of bay connectors enable 1.00mm (0.04") pitch while supporting USB 2.0.

GENERAL SPECIFICATIONS

Number of Contacts	68 pos.
Contact Spacing	1.00mm (0.039")
Current Rating	0.5 Amp per contact
Dielectric Withstanding Voltage	250 VAC r.m.s. (for one minute)
Insulation Resistance	100 megohms min. after test
Contact Resistance	60 milliohms max.
Operating Temperature	-40°C to +85°C
Rated Voltage	AC, 125 V r.m.s.
Life Cycles	5,000 cycles min.

MATERIALS AND FINISHES

• WM1F068N1A / WM1F068U1A

Description	Materials/Finishes
Contact	Copper Alloy Connecting area: Gold Plating Terminal area: Tin Type Plating
Insulator	Heat Resistant Plastic Glass Filled LCP (UL94V-0) Black
Shell	Stainless Steel, Nickel Plating

• WM1M068U1A

Contact	Copper Alloy Connecting area: Gold Plating Terminal area: Tin Type Plating
Insulator	Heat Resistant Plastic Glass Filled LCP (UL94V-0) Black
Shell	Steel, Nickel Plating

ORDERING INFORMATION

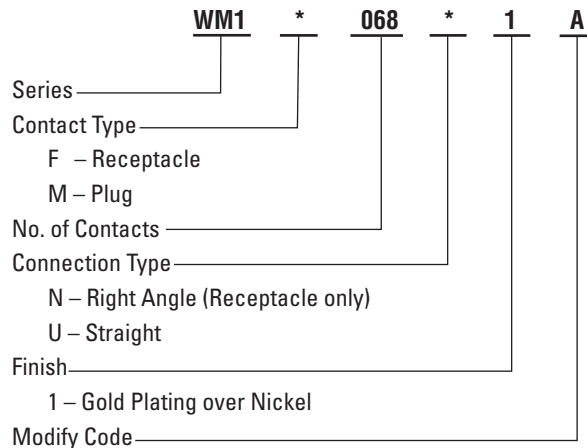

Dimensions and specifications subject to change without notice.

WM2 SERIES CONNECTORS

0.50mm (0.20") Contact Spacing, PCB-to-PCB Bay Connectors



FEATURES

- Compatible with USB 3.0 and SATA signal transmission
- Shell (ground portion) connects first when mating and provides EMI shielding
- High durability--10,000 times mating and un-mating guaranteed
- Two-step contacts for live insertion
- Guide provides ease of blind mating



The WM2 Series is a 0.50mm (0.20") fine pitch bay connector, compliant with USB 2.0 and SATA signals. The series is a SMT right-angle and features full EMI/ESD shielding, blind mating, and two-step contacts for live insertion. Ideal applications are bay modules in notebook computers.

GENERAL SPECIFICATIONS

Number of Contacts	54 pos.
Contact Spacing	0.50mm (0.20")
Contact Resistance	50 milliohms max.
Dielectric Withstanding Voltage	250 VAC r.m.s. (for one minute)
Operating Temperature	-40°C to +85°C
Rated Voltage	0.5A per pin

MATERIALS AND FINISHES

Description	Materials/Finishes
• Receptacle	
Contact	Copper Alloy Contact: 0.1µm. min. Gold plating over Nickel Terminal: Gold flash plating over Nickel
Insulator	Glass Filled LCP (UL94V-0)
Shell	Stainless Steel
• Plug	
Contact	Copper Alloy Contact: 0.1µm. min. Gold plating over Nickel Terminal: Gold flash plating over Nickel
Insulator	Glass Filled LCP
Shell	Stainless Steel
Nut	Steel/ Nickel plating M2

Connector Profile (Ref.)

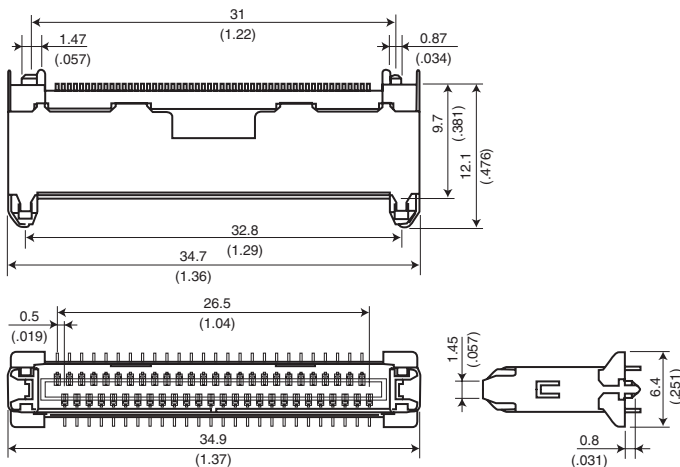

ORDERING INFORMATION

	WM2	*	054	*	P	A
Series						
Contact Type						
	F – Receptacle					
	M – Plug					
No. of Contacts						
Connection Type						
	W – Straight, without hold-down					
	J – Angle SMT, without hold-down					
Plating						
	P – Contact area: Gold Plating 0.1µm min.					
Modify Code						

Dimensions in mm (inches).



TX24/25 SERIES CONNECTORS

1.27mm (.050") Contact Spacing, PCB-to-PCB Connectors

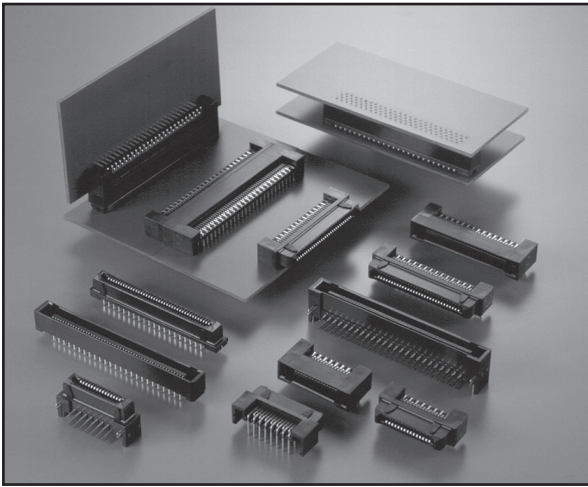

FEATURES

- Non-pin type contacts withstanding mating/unmating twisting forces
- Available for seven parallel board-to-board distances
- Polarizing key for easy insertion
- "Click action" connection
- Prevents solder flux contamination
- Easy PCB pattern

(Note: 1) Stacking Heights

Straight types are available with three insulator heights can be selected within the range of 12 to 24mm (0.472 to 0.945") in 2mm (0.79") intervals, depending on the socket and pin combinations.

Connector Profile (Ref.)

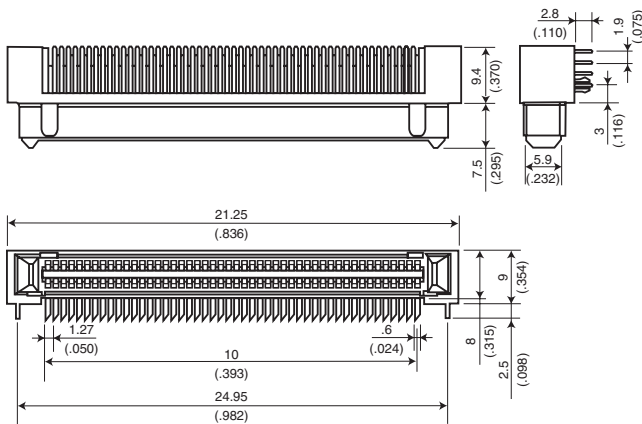

The TX24/25 Series of connectors are designed for PCB-to-PCB applications. Combinations of straight and right angle through hole pin and socket connectors permit horizontal, parallel and vertical interconnection of boards. For straight through hole connectors, the distance for parallel board-to-board connections ranges from 12 to 24mm (0.472 to 0.945") in 2mm (0.079") intervals. A long electrical engagement length results in a highly reliable and stable connection. Non-pin type contacts withstand mating and unmating twisting forces and an excellent "click action" design assures a true connection. The stable housing with polarizing keys is suitable for rack and panel applications.

GENERAL SPECIFICATIONS

Number of Contacts	30, 40, 50, 60, 80, 100
Contact Spacing	1.27mm (.050") 2 rows
PCB Mounting Side Pattern	1.27 x 1.905mm (.50 x .075"), staggered 4 rows
Current Rating	1 Amp
Dielectric Withstanding Voltage	500 VAC r.m.s. (for one minute)
Insulation Resistance	100 megohms min.
Contact Resistance	40 milliohms max.
Operating Temperature	-40°C to +80°C
PCB Thickness	1.6mm (0.063")

MATERIALS AND FINISHES

Description	Materials/Finishes
Insulator	Glass-filled PBT (UL94V-0, Black)
Hook Pin	Copper Alloy/Tin Plating
Contact	Copper Alloy Connection area: Gold plating, 01µm (.000004") min over Nickel Terminal area: Tin plating

ORDERING INFORMATION

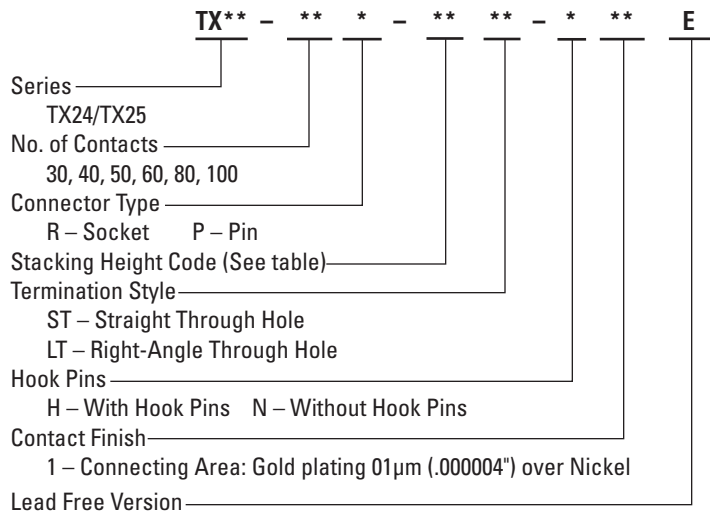

Dimensions and specifications subject to change without notice.

MX19 SERIES CONNECTORS

2.50mm (.098") Contact Spacing, Small Waterproof Relay Connector

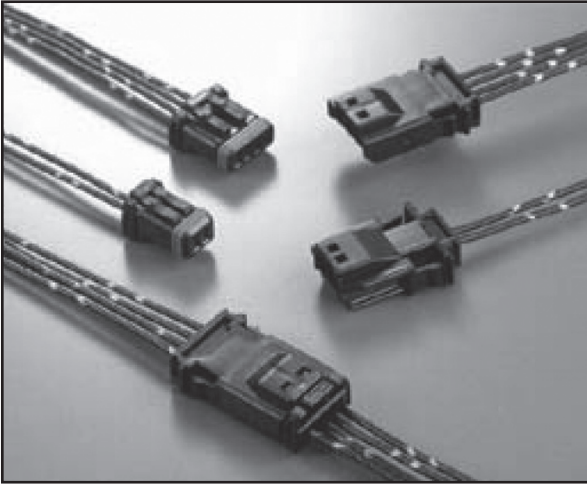

FEATURES

- Mechanical lock mechanism prevents incomplete mating, and improved insertion and removal
- Improved harness assembly and insertion of terminals into housing thanks to a grommet with rear cover
- Rear cover protects the grommet from damage on terminal insertion, withstands cable flaps, and improves waterproof reliability
- Terminals have a two-plate spring mechanism with long beam length, which results in a low force insertion and stress dispersion. The highly reliable contact mechanism can withstand the particular types of vibration caused by an automobile

.....

These small waterproof relay connectors are designed for use in automotive applications. The connectors are designed to withstand harsh environments, and provide an improved harness assembly process thanks to a grommet with a rear cover. The small, proven two-plate spring mechanism improves contact reliability.

GENERAL SPECIFICATIONS

Number of Contacts	2, 4 (Color: Black (Standard), Gray)
Contact Spacing	2.50mm (.098")
Contact Resistance	10 milliohm max.
Withstand Voltage	1000VAC for one minute
Operating Temperature	-40°C to +105°C including temperature rise due to applied current
Waterproofing	Compliant with JIS D0203 S1
Rated Current	5A
Insulation Resistance	100 megohm min.

Applicable Wire

Cable Type	CAVS, AVSS
Cross Section of Conductor	0.3 to 0.5mm ²
A.W.G. No.	#22 to 20
Outer Diameter of Cable	1.4 dia. to 1.7 dia. mm

(Note) Only 0.5mm² is available for AVSS.

MATERIALS AND FINISHES

Components	Materials/Finishes
Insulator	PBT (Black (standard) or Gray)
Contacts	Pin: Copper Alloy Socket: Copper Alloy
Grommet	Silicon Rubber (Brown)
Sealing Ring	Silicon Rubber (Brown)

Consult JAE for "Ordering Information".

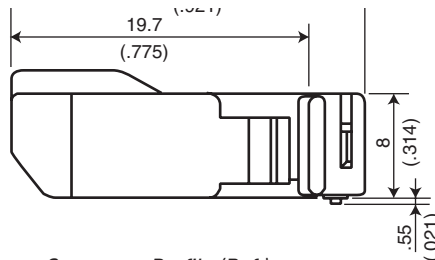
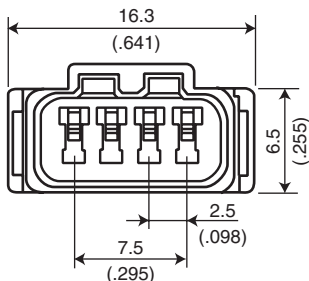
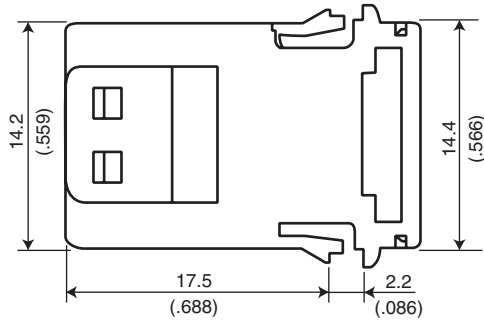

Alphabetical Product Index

<i>Product Series</i>	<i>Pages</i>	<i>Product Series</i>	<i>Pages</i>
AA01A	31	JL05	97 - 98
AA03	28	JN1	90 - 91
CN10	65 - 66	JN2	92 - 93
CV10	67	KD10	73
DA1	84	KX14/15	37 - 38
DD1	77 - 78	LY	72
DD2	79 - 80	MM60	11
DE1	85	MX5	115
DG1	81	MX7	108
DV2	87 - 89	MX9	118
DX2/3	62	MX10	114
FA5	49	MX17	110 - 111
FB3	43	MX19	124
FB5	44	MX23A	112 - 113
FB6	45	MX25	119
FB8	48	MX34	107
FF01	50	MX36	120
FF02	46	N/MS	103 - 104
FF02S	47	PM1	39
FF03	51	PX10/11	12 - 13
FI	59 - 61	PX20/22	14 - 15
FI-E	63 - 64	RA1	82
FI-R	55 - 56	RC1	83
FI-J	53 - 54	SC1	25
FI-X	57 - 58	SC2	24
FO-FC	105	SF2	16
FO-EX	106	SF3	17
IL-312	32	SF6	18
IL-AG5	116	SF7	19
IL-AG6	117	SF7 (Slim)	20
IL-AG7	109	SF9	21
IL-AG9	121 - 123	SG5	22
IL-FPR	52	SRCN	101 - 102
IL-G	74	ST1	26
IL-S	70 - 71	ST2	27
IL-WX	36	ST4	23
IL-Z	68 - 69	TX20	75 - 76
JB1	99 - 100	TX20A	86
JB5	94	TX24/25	42
JC21EJ2	5	WA6	29
JC22	6	WB3	35
JC26C2	7 - 8	WH1	30
JC26E	9	WM1	40
JC26F	10	WM2	41
JL04V	95 - 96	WR	33 - 34

Technology to Inspire Innovation

JAE

***“Building Technologies
to Connect Your World”***



Japan Aviation Electronics Industry, Limited

1-19, Aobadai 3-chome, Meguro-ku
Tokyo 153-8539, Japan
Telephone: 03-3780-2736
Fax: 03-3780-2883

JAE Electronics, Inc.

142 Technology Drive, Suite 100
Irvine, California 92618-2430, U.S.A.
Telephone: 949-753-2600
Fax: 949-753-2699
800-523-7278 Toll free in the U.S.A.

JAE Europe

Coliseum Business Centre
Riverside Way, Camberley
Surrey, GU15 3YL, England
Telephone: 44-1276-404000
Fax: 44-1276-404010

JAE Taiwan, Ltd.

4F-1, No. 88, Chung Hsiao E. Rd.
Sec. 2, Taipei, Taiwan, R.O.C.
Telephone: 886-2-2396-7676
Fax: 886-2-2392-5929

JAE Hong Kong, Ltd.

Suites 1407-11, 14/F, Tower 2, The Gateway,
25 Canton Road, Tsimshatsui, Kowloon, Hong Kong
Telephone: 852-2723-7782
Fax: 852-2723-9028

JAE Korea, Inc.

1602, Korea City Air Tower
159-9 Samsung-Dong, Kangnam-ku
Seoul, 135-973, Korea
Telephone: 82-2-551-8959
Fax: 82-2-551-8958

JAE Philippines, Inc.

PEZA Zone, Gateway Business Park, Javalera
General Trias, 4107 Cavite, Philippines
Telephone: 63-46-433-0285
Fax: 63-46-433-0287

JAE Singapore Pte., Ltd.

33 Tannery Lane, #02-01 Hoesteel
Industrial Building
Singapore 347789
Telephone: 65-6748-1332
Fax: 65-6748-2920

JAE Shanghai Co., Ltd.

RM 1407, Shanghai Mart 2299 Yanan Rd.
West Shanghai 200336 P.R.C.
Telephone: 86-21-6236-0322
Fax: 86-21-6236-1292