

Huco Dynatork Flexible Couplings



 **Huco**[®]
Dynatork

An Altra Industrial Motion Company

Huco Dynatork offers a wide variety of couplings for precision industrial and commercial applications worldwide.



Selecting the right shaft coupling can be the difference between a drive system that provides the required dynamic response and one that is catastrophic. The application constraints lead engineers towards products that have different levels of torsional stiffness, vibration dampening, backlash, and low bearing loads. Huco can respond quickly with a wide variety of couplings such as general purpose, beam style, and precision couplings suitable for highly reliable applications.

Precision Couplings

Flex B Bellows, Flex K Large Bellows and Flex M Disc type couplings are ideal for use in high-end servo drives, pulse generators, scanners, X-Y positioning slides, high speed dynamometers, measuring instruments, robots, and machine tools.



Beam Couplings

Step Beam, Single Beam, Three Beam, and Six Beam couplings are available for use in stepper and servo drives, encoders, tachometers, small pumps, motors and drives and light-duty power transmission applications.



General Purpose Couplings

Oldham couplings are designed for use in stepper drives and most applications including positioning slides, pumps, actuators, etc. Uni-Lat models are ideal for encoder, resolver, tachometers, potentiometer drives, as well as small positioning slides, dosing pumps, and general light drives. Flex P units can be utilized in light power drives, pumps and small generators.



Friction Clutches

Vari-Tork™ friction clutches allow slippage when the torque being transmitted reaches a pre-determined threshold. Used in all types of small drives to help protect personnel and equipment.



Contents

Huco Dynatork

Huco Engineering Industries Ltd.
 Merchant Drive, Hertford, SG13 7BL UK
Tel: +44 (0)1992 501900
Fax: +44 (0)1992 509890

440 North Fifth Avenue
 Chambersburg, PA 17201 - USA
Tel: (888) 829 6637
Fax: (717) 264 6420

Web: www.huco.com
Email: sales@huco.com

Product Overview

Contents

PRODUCT OVERVIEW 2 - 3

SELECTING FLEXIBLE COUPLINGS. 4 - 5

INSTALLING COUPLINGS 6 - 8

HIGH PERFORMANCE COUPLINGS 9 - 21
Membrane, Stainless Steel Bellows, Ni Bellows

GENERAL PURPOSE MOTION CONTROL COUPLINGS. 22 - 28
Huco-Oldham & Uni-Lat

BEAM COUPLINGS. 29 - 41
Single Beam, Multi-Beam, Step Beam











LIGHT POWER DRIVE COUPLINGS. 43 - 46
Jaw (Spider), Double Loop

PLASTIC UNIVERSAL JOINTS & TELESHAFTS 47 - 52
Huco-Pol & Huco Teleshafts















ADJUSTABLE FRICTION CLUTCHES 53 - 56
Huco Vari-Tork, Slip Clutches

BORE ADAPTORS 57 - 58
Huco-Lok

FORMULAE & CONVERSION FACTORS 59 - 61
For Motion Transfer

Stainless Steel Bellows type	Nickel Bellows type	Membrane type	Multi-Beam type	Single-Beam type
Flex B   Flex K 	Flex Ni  	Flex M Single-stage  Short two-stage  Long two-stage 	Multi-Beam 6-Beam   Material Options: Aluminium Stainless Steel Acetal	Single-Beam  Material Options: Aluminium Stainless Steel
General description				
Precision couplings with excellent kinematic properties. The 3 types offer differing combinations of stiffness, radial compensation and axial motion.	Precision couplings with excellent kinematic properties. The 3 types offer differing combinations of stiffness, radial compensation and axial motion.	Precision couplings with excellent kinematic properties. Dynamically balanced construction. Single-stage versions make up into 'whirl' free Cardans. The 2-stage versions offer short envelopes and low bearing loads respectively.	General purpose single piece couplings Single stage (3-beam) Two stage (6-beam) Material options for moisture and corrosion resistance.	More flexible than Multi-Beam but less torsional rigidity.
Where to use				
High-end servo drives, pulse generators, scanners, positioning slides, metering valves, etc.	High-end servo drives, pulse generators, scanners, positioning slides, metering valves, etc.	High-end servo drives, pulse generators, scanners, positioning slides, high speed dynamometers, unsupported drive shafts, etc.	Stepper and servo drives, encoders, general purpose light duty power transmission applications.	Stepper drives, encoders, general purpose light duty power transmission applications.
Speeds				
Flex B up to 5000 rpm Flex K up to 15000 rpm	Up to 5000 rpm	Up to 5000 rpm	Up to 5000	Up to 5000 rpm
Peak torque largest size lbs.-in (Nm)				
4425 (500)	110.6 (12.5)	885 (100)	1239 (140)	266 (30)
Standard bores in. (mm)				
1/8"-2 1/2" (3 to 65)	1/8"-3/4" (3 to 20)	1/8"-1 1/4" (3 to 38)	1/8"-1 1/4" (1 to 38)	1/8"-3/4" (3 to 26)
Temperature range °F (°C)				
-40° to +250°F (-40° to +120°C)	-40° to +250°F (-40° to +120°C)	-40° to +250°F (-40° to +120°C)	-40° to +290°F (-40° to +140°)	-40° to +290°F (-40° to +140°)
Electrically isolating				
No	No	No	Aluminium } Stainless Steel } Acetal Yes	Aluminium } Stainless Steel } Acetal Yes
Connection				
Clamp, Set Screw	Clamp or Set Screw	Clamp or Set Screw	Clamp or set screw	Clamp or Set Screw
Page 9 - 14	Page 16 - 17	Page 18 - 21	Page 29 - 38	Page 40 - 41

Product Overview

Step-Beam type	Sliding Disc type	Universal/Lateral type	Double Loop type	Jaw Coupling	Universal Joints & Teleshfts	Friction Clutches
 <p>Step-Beam</p> <p>Material Options: Nylon</p>	 <p>Oldham Blind bored</p>  <p>Thru' bored</p>  <p>Thru' bored</p> <p>Material Options: Aluminium Stainless Steel Brass</p>	 <p>Uni-Lat</p> 	 <p>Flex-P</p>  	 <p>Flex-G</p>	 <p>Huco-Pol Single joints</p>  <p>Double joints</p>  <p>Teleshfts</p>	 <p>Vari-Tork, Polyclutch Basic clutch</p>  <p>Basic clutch + Oldham coupling</p>

General description

<p>Unique coupling design gives excellent combination of radial flexibility with torsional stiffness.</p>	<p>General purpose, robust, easy to use 3-part couplings with replaceable wear elements. Generous radial compensation and pull-apart / re-engage facility for blind assemblies.</p>	<p>Unique, general purpose light duty couplings with generous angular and radial misalignment compensation. Resist axial motion, can anchor unrestricted shafts and perform light push/pull duties.</p>	<p>Exceptional flexibility in all three directions, radial, angular and axial.</p>	<p>High torque capacity and high speed are available from this naturally balanced coupling.</p>	<p>Light duty plastic universal joints and extensible drive shafts (teleshfts). Low mass, corrosion resistant, ideal where conventional steel joints would be under-utilized.</p>	<p>Small, user-adjustable torque limiters for concentric or in-line mounting. Operate by friction using interleaved clutch plates.</p>
---	---	---	--	---	---	--

Where to use

<p>Encoders, tachogenerators, small pumps, motors and drives.</p>	<p>Stepper drives for most applications including positioning slides, pumps, actuators, etc.</p>	<p>Encoder, resolver, tacho, potentiometer drives. Small positioning slides, dosing pumps, & light drives generally.</p>	<p>Light power drives, pumps and small generators.</p>	<p>Light power drives where misalignment is small.</p>	<p>Intermittent applications in business machines, instrumentation, lab equipment, analytical apparatus, etc., where steel joints would be under-utilized.</p>	<p>Friction clutches interrupt rotation when the load being transmitted reaches a pre-determined threshold. Used in all kinds of small drives to help protect personnel and equipment.</p>
---	--	--	--	--	--	--

Speeds

Up to 10000 rpm.	Up to 3000 rpm.	Up to 3000 rpm.	Up to 3000 rpm.	Up to 40,000 rpm.	Up to 1000 rpm.	Up to 1000 rpm slipping speed.
------------------	-----------------	-----------------	-----------------	-------------------	-----------------	--------------------------------

Peak torque largest size lbs.-in (Nm)

221 (25)	389 (44)	106 (12)	159 (18)	1177 (133)	95 (10.7)	531 (60)
----------	----------	----------	----------	------------	-----------	----------

Standard bores in. (mm)

1/8"-1/2" (3 to 12.7)	1/8"-1" (2 to 30)	1/8"-3/4" (3 to 22)	1/8"-5/8" (3 to 16)	1/8"-5/8" (3 to 16)	1/8"-3/4" (3 to 20)	1/4"-1 1/4" (6 to 32)
-----------------------	-------------------	---------------------	---------------------	---------------------	---------------------	-----------------------

Temperature range

-20 to +300°F (-20 to +150°C)	-20 to +140°F (-20 to +60°)	-20 to +140°F (-20 to +60°)	-40 to +210°C (-40 to +100°)	-40 to +180°F (-40 to +80°)	-20 to +140°F (-20 to +60°)	-10 to +180°F (when operating) (-10 to +80°) (when operating)
----------------------------------	--------------------------------	--------------------------------	---------------------------------	--------------------------------	--------------------------------	--

Electrically isolating

Yes	Yes	Yes	Yes	Yes	Yes	No
-----	-----	-----	-----	-----	-----	----

Connection

Clamp or Set Screw	Clamp or Set Screw	Clamp or Set Screw	Set Screw	Clamp or Set Screw	Set Screw, Bonding, or Cross-Pinning	Clamp or Set Screw
--------------------	--------------------	--------------------	-----------	--------------------	--------------------------------------	--------------------

Selecting Flexible Couplings

Building an Ordering Part Number is fast and easy using the Specifications and Bore Size charts on each product page. Simply select the coupling type, coupling size and two bore sizes you require (always place smaller bore first). Always include (.) in Part Number.

Ordering Number System Example: 536.20.1418

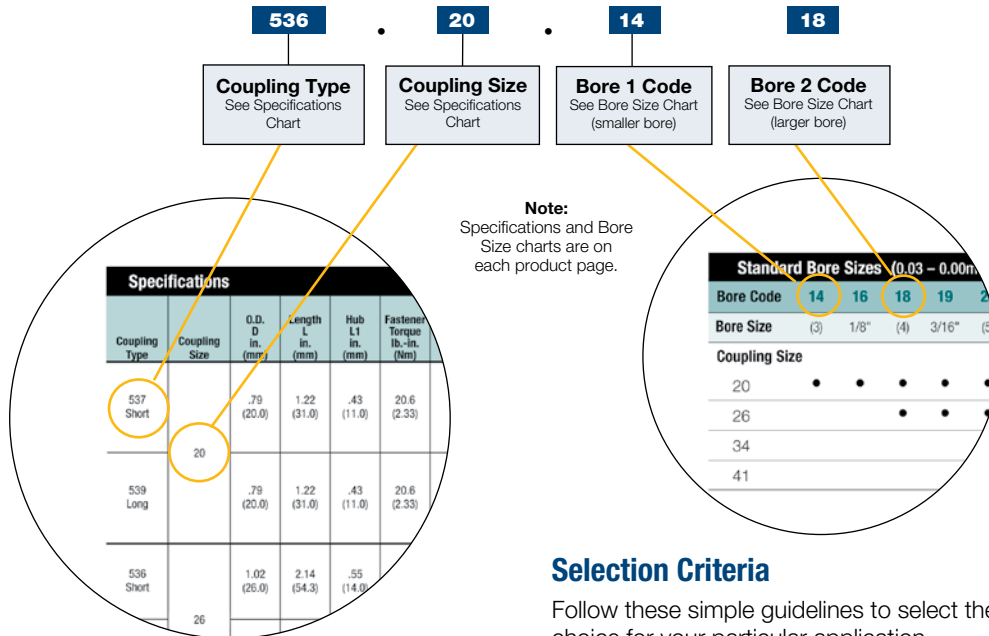

The following key factors should always be considered when specifying flexible shaft couplings:

- Torsional Stiffness
- Backlash
- Torque
- Life
- Shaft Attachment Type
- Misalignment Requirements

Service Factors

- Torque capacity values shown in the coupling specification charts assume uniform load conditions at a constant speed with no misalignment or axial displacement. See page 48 to provide adequate service factors.
- The torque capacity of flexible couplings will reduce when acceleration is present (eg: stop/start or reverse conditions).
- The more severe the acceleration, the greater reduction in torque capacity.
- The more severe the misalignment, the greater reduction in torque capacity.
- Sliding couplings (Oldham and UniLat) are subject to a wear rate dependant on the number of cycles completed and environmental factors.

Selection Criteria

Follow these simple guidelines to select the optimal coupling choice for your particular application.

- Does the coupling provide adequate misalignment protection?
- Can it transmit the required torque?
- Can it sustain the required rotational speed?
- Will it fit in the available space envelope?
- Can it operate at the designated ambient temperature?
- Will it provide the torsional stiffness required for positional accuracy?
- Does it provide electrical isolation between the shafts?
- Will it provide the required life expectancy?
- Is axial motion or axial stiffness required?

	Load				
	Steady State	Stop/Start	Reversing	Shock	Shock & Reversing
Huco Flex B	1.5	2.0	2.0	3.0	4.0
Huco Flex K	1.5	2.0	2.0	3.0	4.0
Huco Flex M	1.5	2.0	2.0	3.0	4.0
Huco Flex Ni	1.0	2.0	2.0	3.0	4.0
Huco Flex P	1.0	1.5	1.5	3.0	4.0
Huco Flex G	1.0	2.0	4.0	4.0	4.0
Huco MultiBeam	1.0	1.5	2.0	(Note 1)	(Note 1)
Huco S-Beam	1.0	1.5	2.0	(Note 1)	(Note 1)
Huco TorqLink	1.0	1.5	2.0	(Note 1)	(Note 1)
Duty (Hours/Day)					
	<1	1-2	3-5	6-12	>12
Huco Oldham	1.0	2.0	4.0	6.0	8.0
Huco Flex-B	1.0	1.5	2.0	3.0	4.0
Uni-Lat	1.0	1.5	2.0	3.0	4.0

* Note 1 - Not recommended in these conditions.

Selecting Flexible Couplings

Round & Keywayed Bore Details & Codes						
Metric mm	Inch fraction	Inch decimal	Round bore code	Metric keys key size w x h	Inch keys key size w x h	Keywayed bore code
1	–	0.0394	08	–	–	–
1.5	–	0.0591	09	–	–	–
1.588	1/16	0.0625	10	–	–	–
2	–	0.0787	11	–	–	–
2.286	–	0.0900	12	–	–	–
2.382	3/32	0.0938	13	–	–	–
3	–	0.1181	14	–	–	–
3.048	–	0.1200	15	–	–	–
3.175	1/8	0.1250	16	–	–	–
*3.969	5/32	0.1563	–	–	–	–
4	–	0.1575	18	–	–	–
4.763	3/16	0.1875	19	–	–	–
5	–	0.1969	20	–	–	–
5.556	7/32	0.2188	21	–	–	–
6	–	0.2362	22	–	–	–
6.096	–	0.2400	23	–	–	–
6.350	1/4	0.2500	24	–	–	–
7	–	0.2756	25	2 x 2	–	P25
7.144	9/32	0.2813	26	–	–	–
7.938	5/16	0.3125	27	–	1/8 x 1/8	R27
8	–	0.3150	28	2 x 2	–	P28
8.731	11/32	0.3438	29	–	1/8 x 1/8	R29
9	–	0.3543	30	3 x 3	–	P30
9.525	3/8	0.3750	31	–	1/8 x 1/8	R31
10	–	0.3937	32	3 x 3	–	P32
11	–	0.4331	33	4 x 4	–	P33
11.113	7/16	0.4375	34	–	1/8 x 1/8	R34
12	–	0.4724	35	4 x 4	–	P35
12.700	1/2	0.5000	36	–	1/8 x 1/8	R36
13	–	0.5118	37	5 x 5	–	P37
14	–	0.5512	38	5 x 5	–	P38
14.288	9/16	0.5625	39	–	3/16 x 3/16	R39
15	–	0.5906	40	5 x 5	–	P40
15.875	5/8	0.6250	41	–	3/16 x 3/16	R41
16	–	0.6299	42	5 x 5	–	P42
17	–	0.6693	43	5 x 5	–	P43
17.463	11/16	0.6875	44	–	3/16 x 3/16	R44
18	–	0.7087	45	6 x 6	–	P45
19	–	0.7480	46	6 x 6	–	P46
19.050	3/4	0.7500	47	–	3/16 x 3/16	R47
20	–	0.7874	48	6 x 6	–	P48
22	–	0.8661	49	6 x 6	–	P49
22.225	7/8	0.8750	50	–	1/4 x 1/4	R50
24	–	0.9449	51	8 x 7	–	P51
25	–	0.9843	52	8 x 7	–	P52
25.400	1	1.0000	53	–	1/4 x 1/4	R53
28	–	1.1024	54	8 x 7	–	P54
28.575	1-1/8	1.1250	55	–	5/16 x 1/4	R55
30	–	1.1811	56	8 x 7	–	P56
31.750	1-1/4	1.2500	57	–	5/16 x 1/4	R57

* Not manufactured. Nearest alternative 4mm.

Round & Keywayed Bore Details & Codes Cont.						
Metric mm	Inch fraction	Inch decimal	Round bore code	Metric keys key size w x h	Inch keys key size w x h	Keywayed bore code
32	–	1.2598	58	10 x 8	–	P58
34.925	1-3/8	1.3750	59	–	3/8 x 1/4	R59
35	–	1.3780	60	10 x 8	–	P60
38	–	1.4961	61	10 x 8	–	P61
38.10	1-1/2	1.5000	62	–	–	Specify on Order
40	–	1.5748	63	–	–	Specify on Order
41.28	1-5/8	1.6250	64	–	–	Specify on Order
42	–	1.6535	65	–	–	Specify on Order
44.45	1-3/4	1.7500	66	–	–	Specify on Order
45	–	1.7717	67	–	–	Specify on Order
47.63	1-7/8	1.8750	68	–	–	Specify on Order
48	–	1.8898	69	–	–	Specify on Order
50	–	1.9685	70	–	–	Specify on Order
50.80	2	2.0000	71	–	–	Specify on Order
53.98	2-1/8	2.1250	72	–	–	Specify on Order
55	–	2.1654	73	–	–	Specify on Order
57.15	2-1/4	2.2500	74	–	–	Specify on Order
60	–	2.3622	75	–	–	Specify on Order
60.33	2-3/8	2.3750	76	–	–	Specify on Order
63.50	2-1/2	2.5000	77	–	–	Specify on Order
65	–	2.5591	78	–	–	Specify on Order
73.03	2-7/8	2.8750	79	–	–	Specify on Order
75	–	2.9528	80	–	–	Specify on Order

Specifying a Keywayed Bore

To specify a keywayed bore, prefix the 2-digit bore code number with a “P” for metric keyways or an “R” for an inch keyway.

Examples:

Metric: 538.34.P28P28

In this example both bores have a keyway.

Inch: 538.34.24R36

In this example only the second bore will have a keyway.

Standard keyways are machined to two specifications:

- Bore Codes prefixed with a “P” denote a metric keyway conforming to ISO 773/774 (BS 4235 Pt. 1).
- Bore Codes prefixed with a “R” denote an inch keyway conforming to BS 46 Pt. 1.

Installing Couplings

Flexible Coupling Types

General instructions

1. Ensure that shafts are free of burrs, damage, or foreign matter, and can penetrate the bores.
2. Install the coupling by holding the shaft and the related hub, rotating it back and forth as you progress it along the shaft.
3. Do not apply any forces that cause extension, compression or lateral displacement of the coupling beyond its permissible offsets.

Normal installation

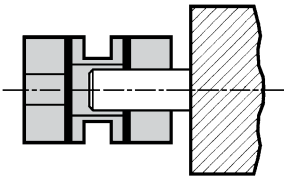

- a) Position and secure the larger of the 2 shafts (if different) and progress the coupling onto it.

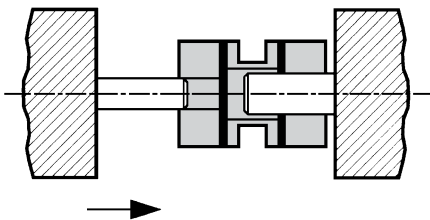

- b) Progress the second shaft into the bore, taking care not to lever either shaft against the inner wall of the spacer.

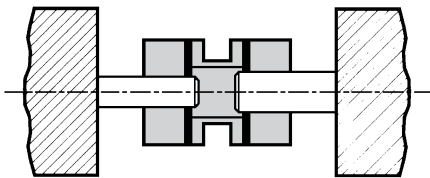

- c) Progress the coupling along the shafts to a position midway between the shaft terminations. Rotate the coupling to ensure it is not binding and is in its natural state, i.e., neither extended nor compressed.
- d) Align the second shaft with the first using a straight edge and feeler gauges or a dial indicator.
- e) Secure the second shaft and re-check alignment. Final alignment must be within the permissible offsets.
- f) Secure one hub, tightening each screw alternately. Repeat for the second hub.

When to use single & two-stage couplings

Single-stage

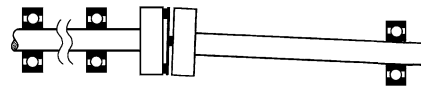

Example 1. With partially supported (1 bearing) shafts.

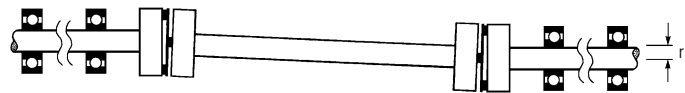

Example 2. With unsupported intermediate shafts.

Single-stage couplings are radially supportive and function as supplementary bearings. They are used when the connected shaft lacks a full complement of bearings.

Two-stage



Two-stage couplings are radially compliant and are used when both shafts are fully supported by bearings.

CAUTION

These are precision high couplings that have a limited range of permissible flexure. They can be damaged through careless handling. Avoid gratuitous flexure in any direction.

No axial forces are permitted across the membranes when fitting Huco-Flex M couplings. Keyways with interference fits are not recommended.

Bellows couplings are more tolerant of axial motion, but flexure beyond the permissible limits should be avoided.

Note: Bellows couplings do not provide the same level of radial support as Flex M when used with partially or wholly unsupported shafts. When essential for reasons of greater axial motion, use the 3-convolution type for these purposes.

Sliding Disc type (Oldham)

Blind hub

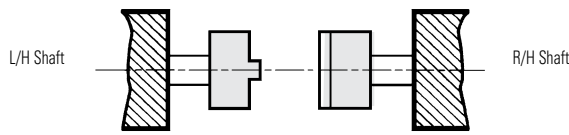

- Slide hubs on to both shafts until fully seated and tighten screws.
- Position and secure R/H shaft.

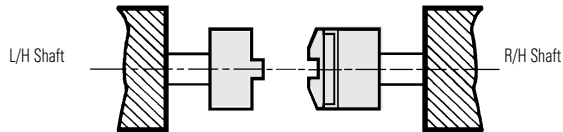

- Seat disc fully on R/H hub.

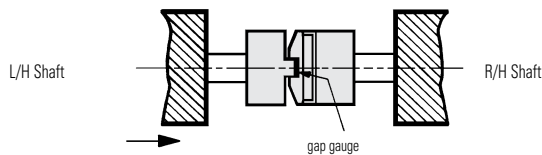

- Place a gap gauge flat against the bottom of the exposed slot in the disc and push the L/H hub into full engagement by manipulating the L/H shaft.
- Align shafts within the permissible offsets and secure L/H shaft.
- Check alignment and correct if necessary.
- Remove gap gauge.

To fit a new disc, withdraw L/H shaft complete with hub and remove old disc. Repeat steps c) to g).

Thro' hub

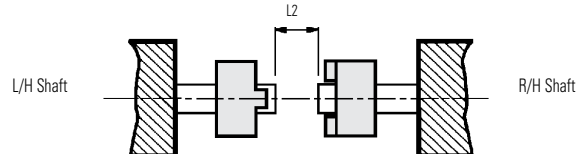

- Slide hubs on to both shafts.
- Align shafts to within the permissible offsets and position to leave *minimum* gap 2 between terminations. Secure both shafts, check alignment and correct if necessary.

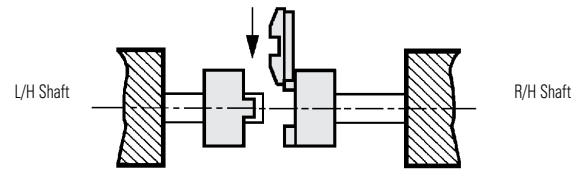

- Position R/H hub with inboard face flush with shaft termination and tighten screws.
- Slide disc radially on to the tenons of the R/H hub. Ensure the disc is fully seated.

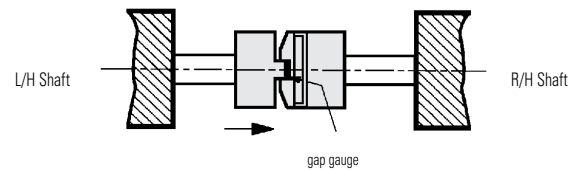

- Place a gap gauge flat against the bottom of the exposed slot in the disc and push the L/H hub into full engagement.
- Tighten fastening screws and remove gap gauge.

To fit a new disc, slacken the fastening screws on one hub and retract it along the shaft. Slide the old disc out radially and replace with the new. Repeat steps d) to f).

To retain shaft phasing, withdraw L/H shaft and repeat steps c) to g) as for Blind hub couplings.

Over-penetration of shafts can impair function of coupling with solid disc. Min shaft gap L2 must be observed. Specify thro' bored disc for near-butted shafts.

Coupling size	19	25	33	41	50	57
L2 min	0.28 (7.2)	0.36 (9.2)	0.47 (12.0)	0.60 (15.3)	0.72 (18.4)	0.83 (21.2)

Gap gauges for all hub types

Coupling size	06, 09 & 13	19 & 25	33 & 41	50 & 57	Gap gauge
					0.002 (0.05)
					0.004 (0.10)
					0.006 (0.15)
					0.008 (0.20)

Clearances are set to allow for thermal shaft growth and / or end-float. Gaps may be increased, but total shaft movement should not exceed the values shown under *Axial Compensation* in the Performance Table.

Radial support

Shafts must be fully supported by 2 bearings and have minimal overhang. Oldham couplings cannot be used in pairs.

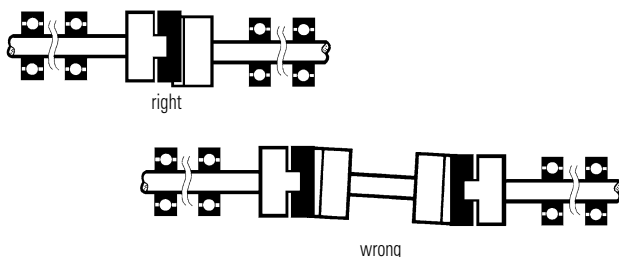

Note: It is important that installed couplings are not end-loaded. To help avoid this, thro' bored hubs are recommended for shafts which have fixed axial locations such as face-mounted motors.

Clamp hubs

To improve clamp action, apply a little grease under the head of the clamp screw.

Installing Couplings

Beam Type

Relief Under The Beams

Most Multi-Beam couplings can be supplied with or without relief under the beams as shown in the diagrams below. When the drive or driven shafts extend under the beams relief is essential to ensure that the coupling remains flexible. Where non-relieved versions are used, shafts must not be allowed to penetrate under the beamed section of the coupling. Unless otherwise specified, relieved versions will be supplied.

Pilot Bores

Couplings can be supplied 'pilot bored' for opening out by the customer. Pilot bores are plain drilled holes, which are not produced with the same accuracy as finished machined bores. The largest bore provided in a pilot bored product is that needed to make the coupling flexible and this will always be larger than the minimum possible bore size 'B1' shown in the bore tables. For sizes 13 to 25, the pilot bore is also larger than the 'B2' minimum shown in the bore tables. Further details are available on request.

Non-Relieved

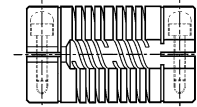
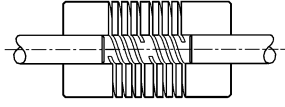
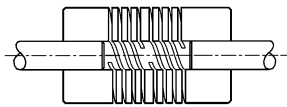

Relieved

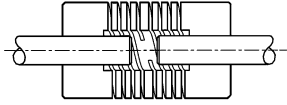



High Performance Couplings

- Stainless Steel Bellows
- Nickel Bellows
- Flexible Membrane (Disc)
 - **Torsionally rigid design**
 - **No moving parts**
 - **All-metal construction**
 - **Low inertia**

The operating principles of Flex B, Flex K, Flex Ni and Flex M offer the highest performance available with flexible couplings.

With excellent kinematic properties and torsional stiffness of a very high order, they are suitable for servo drives and satisfy the criteria for highly dynamic position and velocity control systems.

Bellows couplings have the greater torsional stiffness while Flex M have the more tolerant flexural system and feature dynamically balanced construction.



Stainless Steel Bellows Couplings

Set screw hubs

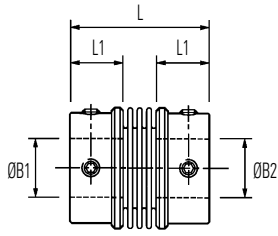

Ref. 530
Short type
for precisely aligned shafts

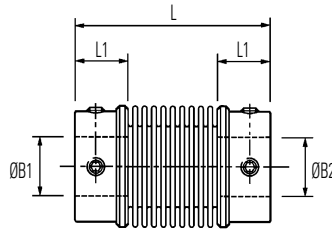

Ref. 532
Long type
for greater angular offsets
or axial motion

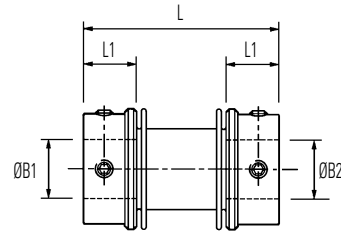

Ref. 534
Stretched type
for greater radial misalignment
and lower bearing loads

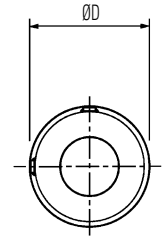

Typical

Clamp hubs

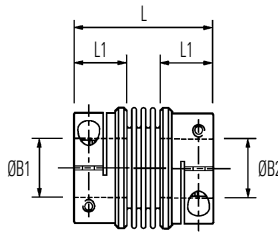

Ref. 536
Short type
for precisely aligned shafts

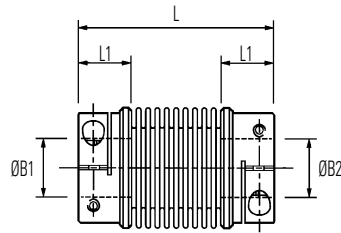

Ref. 538
Long type
for greater angular offsets
or axial motion

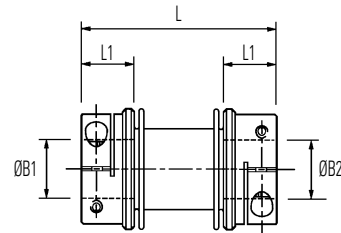

Ref. 540
Stretched type
for greater radial misalignment
and lower bearing loads

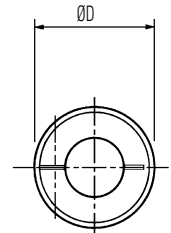

Typical

Comparative properties

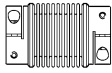
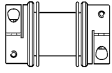
	Short	Long	Stretched
Parameter			
Peak Torque	2	1	3
Torsional Stiffness	3	1	2
Angular Compensation	2	3	1
Axial Compensation	2	3	1
Radial Compensation	1	3	2

The properties of the 3 types compared on a scale of 1 to 3.
3 = best.

Materials & Finishes

Hubs: Al. Alloy 2014T6 and Clear anodised finish

Bellows: Spring quality stainless steel

Joint assembly: Copper C106, heat treated Zinc plate, clear passivate

Fasteners: Alloy steel, black oiled

Temperature Range

-40°F to + 248°F

(-40°C to +120°C)

Stainless Steel Bellows Couplings

DIMENSIONS & ORDER CODES

Coupling Size	Set Screw Hubs	Clamp Hubs	ØD in. (mm)	① L in. (mm) ±1.0	L1 in. (mm)	ØB1, ØB2 max in. (mm)	Fasteners			③ Moment of inertia kgm ² x 10 ⁻⁸	③ Mass kg x 10 ⁻³
							Screw	② Torque lb-in. (Nm)	Wrench in. (mm)		
COUPLING REF											
20	530.20	—	.79 (20.0)	1.22 (31.0)	.43 (11.0)	0.31 (8)	M4	20 (2.27)	0.08 (2)	90	18
	532.20	—		1.77 (45.2)						100	19
	534.20	—		1.72 (43.6)						90	18
	—	536.20		1.22 (31.0)			M2.5	11.6 (1.32)	0.08 (2)	90	16
	—	538.20		1.78 (45.2)						100	18
	—	540.20		1.72 (43.6)						90	17
26	530.26	—	1.02 (26.0)	1.48 (37.5)	.55 (14.0)	0.47 (12)	M5	40.9 (4.62)	0.10 (2.5)	350	35
	532.26	—		2.14 (54.3)						400	39
	534.26	—		2.09 (53.2)						370	34
	—	536.26		1.48 (37.5)			M3	21.5 (2.43)	0.10 (2.5)	330	34
	—	538.26		2.14 (54.3)						380	38
	—	540.26		2.09 (53.2)						350	33
34	530.34	—	1.34 (34.0)	1.57 (40.0)	.55 (14.0)	0.63 (16)	M5	40.89 (4.62)	0.10 (2.5)	975	58
	532.34	—		2.24 (57.0)						1128	65
	534.34	—		2.23 (56.6)						988	59
	—	536.34		1.57 (40.0)			M3	21.5 (2.43)	0.10 (2.5)	925	56
	—	538.34		2.24 (57.0)						1078	63
	—	540.34		2.23 (56.6)						938	57
41	530.41	—	1.61 (41.0)	1.96 (49.7)	.71 (18.0)	0.79 (20)	M6	67.3 (7.61)	0.11 (3)	2490	102
	532.41	—		2.81 (71.4)						2740	110
	534.41	—		2.78 (70.7)						2477	102
	—	536.41		1.96 (49.7)			M4	50.0 (5.66)	0.11 (3)	2390	99
	—	538.41		2.81 (71.4)						2660	107
	—	540.41		2.78 (70.7)						2377	99

IMPORTANT

Load capacity depends on application conditions: **see page 4** for details

PERFORMANCE

Coupling Size	Ref.	④ Peak torque lb-in. (Nm)	⑤ Max compensation			⑥ Flexural stiffness			
			Angular deg	Radial in. (mm)	Axial in. (± mm)	Torsional Nm / rad	Angular N / deg	Radial N / mm	Axial N / mm
20	530 & 536	17.7 (2.0)	2	.002 (0.06)	0.14 (0.35)	315	1.03	115	17.7
	532 & 538	8.8 (1.0)	6	.020 (0.50)	.038 (1.00)	170	0.33	6.7	7.8
	534 & 540	21.1 (2.5)	1.3	.007 (0.20)	.007 (0.20)	225	0.33	8.2	7.1
26	530 & 536	28.3 (3.2)	2	.002 (0.06)	.014 (0.36)	755	1.27	238	5.7
	532 & 538	14.2 (1.6)	6	.020 (0.50)	.039 (1.00)	380	0.39	8.2	3.3
	534 & 540	35.4 (4.0)	1.3	.007 (0.20)	.007 (0.20)	615	1.52	14.6	6.4
34	530 & 536	66.4 (7.5)	2.5	.003 (0.10)	.024 (0.60)	1740	1.34	227	6.6
	532 & 538	33.6 (3.8)	8	.039 (1.00)	.075 (1.90)	915	0.62	12.7	3.8
	534 & 540	83.2 (9.4)	1.5	.012 (0.30)	.012 (0.30)	1455	1.98	23.2	27.9
41	530 & 536	88.5 (10.0)	2.5	.006 (0.15)	.031 (0.80)	2880	1.58	144	13.1
	532 & 538	44.3 (5.0)	8	.047 (1.20)	.098 (2.50)	1310	0.52	9.3	3.8
	534 & 540	111 (12.5)	1.8	.016 (0.40)	.020 (0.50)	2245	2.30	19.2	7.2

- ① Length of supported thro' bore. Shafts can near-butt.
- ② Maximum recommended tightening torque.
- ③ Values apply with max bores.
- ④ **Peak torque.** Select a size where Peak Torque exceeds the application torque x service factor. (**see page 4**)
- ⑤ Max. compensation values are mutually exclusive.
- ⑥ Torsional stiffness values apply at 50% peak torque with no misalignment, measured shaft-to-shaft with largest standard bores. **Note that in some vendors' catalogs the given torsional stiffness applied to the un-mounted bellows element only, an unrepresentative calculated value.**

STANDARD BORES

Coupling Size	ØB1, ØB2 +0.0012/ -0 (+0.03mm/-0mm)																					
	(3)	1/8"	(4)	3/16"	(5)	(6)	1/4"	(8)	(9)	3/8"	(10)	(11)	(12)	1/2"	(14)	(15)	5/8"	(16)	(18)	(19)	3/4"	(20)
20	•	•	•	•	•	•	•	•														
26			•	•	•	•	•	•														
34					•	•	•	•														
41							•	•														
Bore ref.	14	16	18	19	20	22	24	28	30	31	32	33	35	36	38	40	41	42	45	46	47	48
Corresponding bore adaptor					251		253	255			257			259				260				261

Diameters for which a bore adaptor is shown can be adapted to smaller shaft sizes. See page 58 for details of metal bore adaptors.

Stainless Steel Bellows Couplings

Set screw hubs

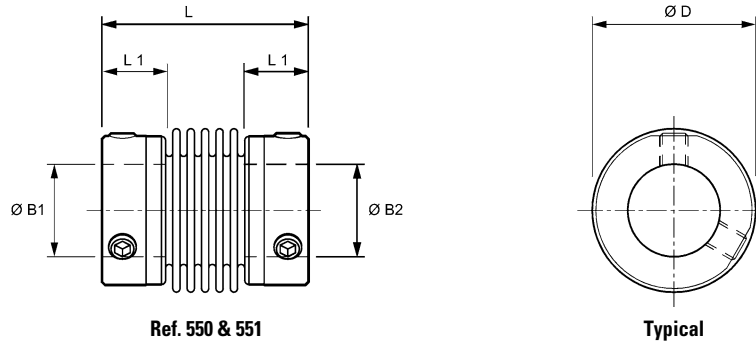

Clamp hubs

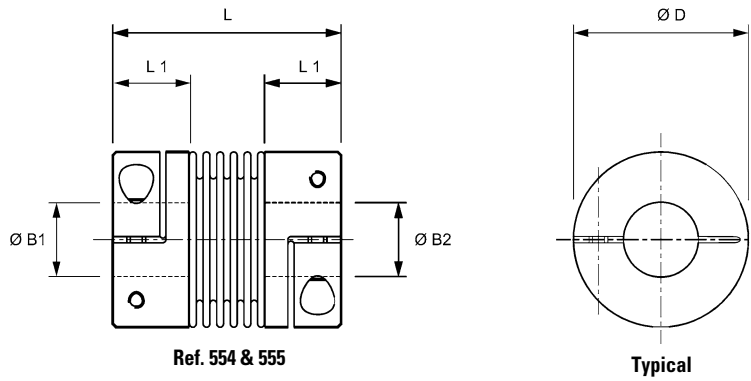

Materials & Finishes

Hubs: Al. Alloy [Clamp hubs size 66 and larger - steel]

Bellows: Spring quality stainless steel

Fasteners: Alloy steel, black oiled

Temperature Range

-30°F to + 248°F

(-30°C to +120°C)

Stainless Steel Bellows Couplings

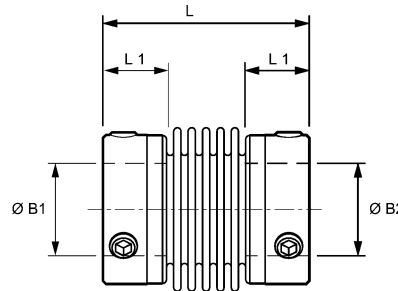

Ref. 550 & 551

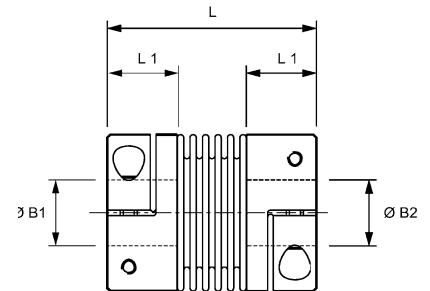

Ref. 554 & 555

DIMENSIONS & ORDER CODES

Coupling Size	Set Screw Hubs	Clamp Hubs	ØD in. (mm)	L in. (mm)	L1 in. (mm)	ØB1, ØB2 Max in. (mm)	Fasteners			Moment of inertia kgm ² x10-8	Mass kgx10-3	
							Screw	Torque lb-in. (Nm)	Wrench in. (mm)			
COUPLING REF												
10	550.10	-	0.39 (10.0)	0.91 (23.0)	0.24 (6.0)	0.16 (4.0)	M3	4.43 (0.5)	0.06 (1.5)	4	3	
	-	554.10		0.98 (25.0)	0.28 (7.0)		M1.6	0.89 (0.1)		5	2.6	
16	550.16	-	0.59 (15.0)	0.83 (21.0)	0.25 (6.0)	0.31 (8.0)	M3	4.43 (0.5)	0.06 (1.5)	17	4.1	
	551.16	-		0.98 (25.0)						19	4.6	
	-	554.16	0.61 (15.5)	0.91 (23.0)	0.31 (8.0)	0.28 (7.0)	M2	3.81 (.43)		30	7.6	
	-	555.16		1.02 (26.0)						33	7.9	
20	550.20	-	0.75 (19.0)	1.02 (26.0)	0.31 (8.0)	0.47 (12.0)	M4	13.3 (1.50)	0.08 (2.0)	51	5.3	
	551.20	-		1.18 (30.0)						65	7.3	
	-	554.20	0.79 (20.0)	1.02 (26.0)	0.35 (9.0)	0.39 (10.0)	M2.5	7.52 (.85)		75	9.5	
	-	555.20		1.22 (31.0)						88	11.5	
25	550.25	-	0.94 (24.0)	0.87 (22.0)	0.25 (6.0)	0.55 (14.0)	M4	13.3 (1.50)	0.08 (2.0)	80	6	
	551.25	-		1.10 (28.0)						114	8	
	-	554.25	0.98 (25.0)	1.26 (32.0)	0.43 (11.0)	0.5 (12.7)	M3	17.7 (2)		0.10 (2.5)	225	17
	-	555.25		1.65 (42.0)							275	22
33	550.33	-	1.26 (32.0)	1.57 (40.0)	0.47 (12.0)	0.71 (18.0)	M6	26.6 (3.00)	0.12 (3.0)	613	29	
	551.33	-		1.89 (48.0)						723	35	
	-	554.33	1.28 (32.5)	1.61 (41.0)	0.55 (14.0)	0.63 (16.0)	M4	30.9 (3.50)		950	48	
	-	555.33		1.89 (48.0)						0.61 (15.5)	1036	51
41	550.41	-	1.57 (40.0)	1.77 (45.0)	0.47 (12.0)	0.94 (24.0)	M6	26.6 (3.00)	0.12 (3.0)	1285	32	
	551.41	-		2.17 (55.0)						1885	51	
	-	554.41	1.59 (40.5)	1.89 (48.0)	0.55 (14.0)	0.87 (22.0)	M4	39.8 (4.50)		2150	59	
	-	555.41		2.24 (57.0)						2750	79	

PERFORMANCE

Coupling Size	Ref.	Peak torque lb-in. (Nm)	Max compensation ^⑤			Flexural Stiffness ^⑥		
			Angular deg	Radial in. (mm)	Axial in. (±mm)	Torsional Nm/rad	Radial N/mm	Axial N/mm
10	550 & 554	0.89 (0.1)	1.2	.004 (.12)	0.008 (.2)	65	10	14
16	550 & 554	8.85 (1.0)	1.0	.003 (.10)	0.008 (.2)	510	74	27
	551 & 555		1.5	.006 (.15)	0.01 (0.3)	380	31	20
20	550 & 554	13.3 (1.5)	1.5	.003 (0.10)	0.01 (0.3)	750	59	15
	551 & 555		2.0	.006 (0.15)	0.02 (0.4)	700	20	9
25	550 & 554	17.7 (2.0)	1.5	.006 (0.15)	0.01 (0.3)	1500	67	12
	551		1.5	.008 (0.20)	0.02 (0.4)	1300	21	11
33	550, 5554 & 555	39.83 (4.50)	2.0	.010 (0.25)	0.02 (0.5)	1050	11	9
	551		1.5	.003 (0.10)	0.01 (0.3)	6500	168	32
41	550 & 554	88.5 (10.0)	2.0	.008 (0.20)	0.02 (0.5)	4200	41	20
	551 & 555		1.5	.006 (0.15)	0.16 (0.4)	8100	120	27
			2.0	.012 (0.30)	0.02 (0.6)	6800	29	17

Flex-K

Stainless Steel Bellows Couplings

CLAMP HUBS

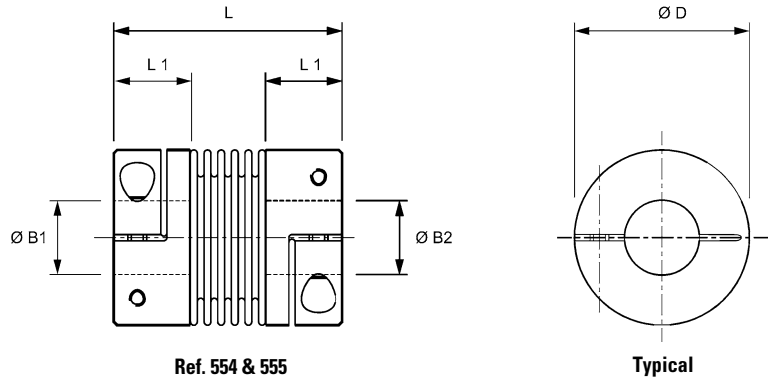

Ref. 554 & 555

Typical

DIMENSIONS & ORDER CODES

Coupling Size	Set Screw Hubs	Clamp Hubs	ØD in. (mm)	L in. (mm)	L1 ^① in. (mm)	ØB1, ØB2 Max in. (mm)	Fasteners			Moment of inertia ^③ kgm ² x10-8	Mass ^③ kgx10-3
							Screw	Torque ^② lb-in. (Nm)	Wrench in. (mm)		
COUPLING REF											
45	-	554.45	1.77 (45.0)	2.48 (63.0)	0.77 (19.5)	1.00 (25.4)	M5	8.0	4.0	3560	54
	-	555.45		2.78 (71.0)						4560	104
56	-	554.56	2.20 (56.0)	2.56 (65.0)	0.96 (24.5)	1.18 (30.0)	M6	15.0	5.0	13930	215
	-	555.56		2.87 (73.0)						14930	235
66	-	554.66	2.60 (66.0)	3.11 (79.0)	1.14 (29.0)	1.26 (32.0)	M8	40.0	6.0	31360	390
	-	555.66		3.50 (89.0)						34360	490
82	-	554.82	3.23 (82.0)	3.58 (91.0)	1.32 (33.5)	1.65 (42.0)	M10	84.0	8.0	183930	1150
	-	555.82		4.02 (102.0)						193930	1250
90	-	554.90	3.54 (90.0)	3.98 (101.0)	1.50 (38.0)	1.77 (45.0)	M12	125.0	10.0	305980	1875
	-	555.90		4.45 (113.0)						325980	1975
110	-	554.110	4.33 (110.0)	4.133 (105.0)	1.50 (38.0)	2.36 (60.0)	M12	125.0	10.0	654095	2330
	-	555.110		4.57 (116.0)						674095	2430
122	-	554.122	4.80 (122.0)	4.41 (112.0)	1.65 (42.0)	2.56 (65.0)	M12	125.0	10.0	1124450	3540
	-	555.122		4.84 (123.0)						1154450	3640

PERFORMANCE

Coupling Size	Ref.	Peak torque ^④ lb-in. (Nm)	Max compensation ^⑤			Flexural Stiffness ^⑥		
			Angular deg	Radial in (mm)	Axial in. (±mm)	Torsional Nm/mm	Radial N/mm	Axial N/mm
45	554	159 (18)	1.5	.008 (0.20)	.020 (0.5)	20000	790	100
	555		2.0	.010 (0.25)	.020 (0.5)	15000	970	85
56	554	266 (30)	1.5	.006 (0.15)	.024 (0.6)	38000	720	50
	555		2.0	.010 (0.25)	0.04 (1.0)	28000	225	28
66	554	531 (60)	1.5	.006 (0.15)	.024 (0.6)	75000	1150	90
	555		2.0	.010 (0.25)	.040 (1.0)	50000	340	50
82	554	1328 (150)	1.5	.008 (0.20)	.020 (0.5)	155000	1200	145
	555		2.0	.010 (0.25)	.020 (0.5)	105000	400	185
90	554	1770 (200)	1.5	.008 (0.20)	.020 (0.5)	175000	2020	145
	555		2.0	.010 (0.25)	.031 (0.8)	120000	595	82
110	554	2655 (300)	1.5	.008 (0.20)	.020 (0.5)	502000	2500	280
	555		2.0	.010 (0.25)	.031 (0.8)	285000	460	145
122	554	4425 (500)	1.5	.008 (0.20)	.020 (0.5)	690000	6300	100
	555		2.0	.010 (0.25)	.040 (1.0)	320000	1400	85

- ① Length of supported bore
- ② Maximum recommended tightening torque
- ③ Values apply with Max. Bores

- ④ Peak Torque. Select a size where Peak Torque exceeds the application torque x service factor (see page 4)
- ⑤ Max. compensation values are mutually exclusive
- ⑥ Torsional stiffness values apply at peak torque with no misalignment

Nickel Bellows Couplings



Set Screw Hubs

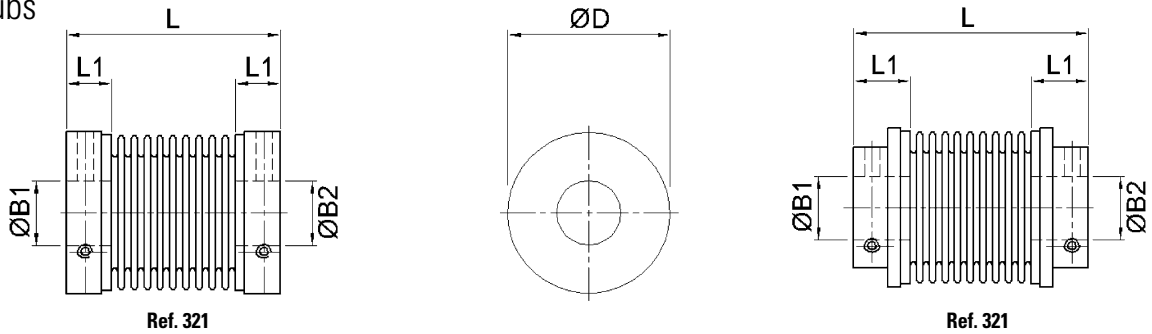

Clamp Hubs

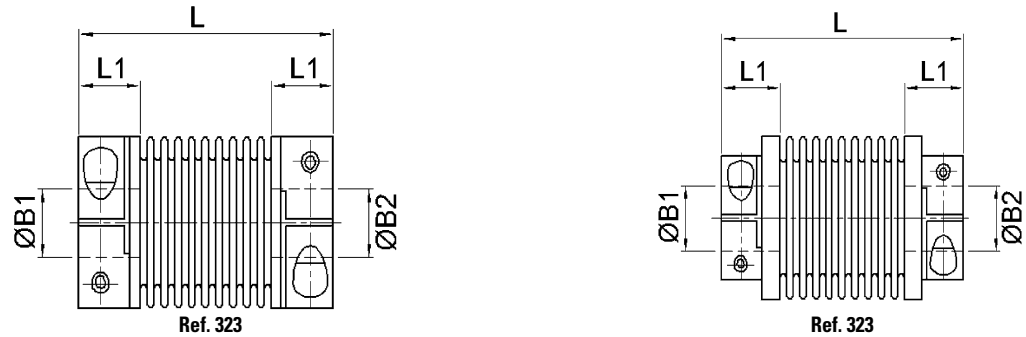

The convolutions of Flex-Ni Couplings are formed by the electrolytic deposition of nickel. This produces stress-free convolutions with closely controlled wall thickness.

Nickel bellows couplings are characterized by their exceptional quality of rotational positional integrity. This is achieved through high torsional stiffness in a coupling that is still able to accommodate large amounts of lateral and angular misalignment due to low spring rates in these directions. These couplings are used primarily in instrumentation and similar sensitive applications.

Materials & Finishes

Hubs: Aluminium Alloy

Bellows: Electrodeposited nickel

Fasteners: Alloy steel

Temperature Range

-50°F to + 248°F

(-50°C to +120°C)

Nickel Bellows Couplings

DIMENSIONS & ORDER CODES

Size	Number of convolutions	Order Code		Dimensions						Fasteners		
		Set Screw Hub	Clamp Hub	O.D in. (mm)	O/A Length L in. (mm)	Max Shaft Depth L1 in. (mm)	Max Bores	Moment of Inertia kgm ² x 10 ⁻⁸	Mass kg x 10 ⁻³	Size	Torque lb-in. (Ncm)	A/F in. (mm)
7	8	321.07	-	0.25 (6.35)	0.55 (14)	0.16 (4)	3.175	1.3	1.5	M2	3.63 (41)	.035 (0.9)
12	14	321.12	-	0.47 (12)	0.91 (23)	0.24 (6)	6.35	18.5	10	M2.5	6.99 (79)	.051 (1.3)
17	14	321.17	-	0.67 (17)	1.22 (31)	0.28 (7)	10	36.2	8.5	M3	11.68 (132)	.060 (1.5)
		-	323.17	0.64 (16.3)	1.30 (33)	0.31 (8)	6.35	46.6	11.0	M2	3.10 (35)	0.60 (1.5)
25	10	321.25	-	0.98 (25)	1.30 (33)	0.28 (7)	12.7	161.0	19.5	M3	11.68 (132)	0.60 (1.5)
		-	323.25	0.98 (25)	1.46 (37)	0.35 (9)	12.7	245.0	28.5	M2.5	5.84 (66)	0.08 (2.0)
36	7	321.36	-	1.43 (36.3)	1.67 (42.3)	0.37 (9.5)	19.05	601.0	39.0	M6	45.14 (510)	0.12 (3.0)
		-	323.36	1.43 (36.3)	1.85 (46.9)	0.46 (11.8)	19.05	2960.0	85.0	M4	23.19 (262)	0.12 (3.0)
50	11	321.50	-	2.00 (51)	2.33 (59.3)	0.41 (10.5)	20	952.0	52.0	M6	76.12 (860)	0.12 (3.0)
		-	323.50	2.00 (51)	2.44 (61.9)	0.46 (11.8)	20	3560.0	105.0	M4	23.19 (262)	0.12 (3.0)

PERFORMANCE

Size	Peak Torque lb-in. (Ncm)	Wind up Arcs/Ncm	Max misalignment compensation			Nominal Spring Rates			
			Angular Deg	Radial in. (mm)	Axial in. (mm)	Torsional (Nm/rad)	Angular (N/deg)	Radial (N/mm)	Axial (N/mm)
7	0.434 (4.9)	285	10	.007 (0.19)	.026 (0.65)	7	<0.15	6.9	3.5
12	1.15 (13)	75	15	.021 (0.54)	.068 (1.72)	27	<0.15	4.2	2.2
17	4.42 (50)	20	10	.017 (0.43)	.070 (1.78)	103	0.15	12.3	4.0
25	29.03 (328)	4.0	8	.018 (0.46)	.081 (2.07)	515	0.41	38.1	11.2
36	81.25 (918)	1.2	6	.018 (0.46)	0.13 (3.28)	1719	0.32	87.8	20.2
50	143.7 (1624)	0.6	9	.044 (1.12)	0.24 (6.1)	3438	<0.15	57.8	17.6

AVAILABLE BORES

Sizes indicated in parenthesis are metric (mm).

Size	Ø B1, B2 H8														
	(3)	1/8"	(4)	3/16"	(5)	(6)	1/4"	(8)	3/8"	(10)	(12)	1/2"	(16)	3/4"	(20)
7	•	•	•												
12	•	•	•	•	•	•	•								
17	•	•	•	•	•	•	•	S	S	S					
25						•	•	•	•	•	•	•			
36										•	•	•	•		
50											•	•	•	•	•
Bore Ref.	14	16	18	19	20	22	24	28	31	32	35	36	42	47	48

S = Setscrew only

IMPORTANT

Load capacity depends on application conditions:
see page 4 for details

Flexible Membrane Couplings - Rivetted Series

Materials & Finishes

- Hubs & spacer:** Al. Alloy 2014 T6
Clear anodised finish
- Membranes:** Spring quality stainless steel
Heat treated
- Rivet assembly:** Brass rivets flanked by formed steel washers
Steel, zinc plate & colour passivate
- Fasteners:** Alloy steel, black oiled



Temperature Range

-40°F to +248°F (-40°C to +120°C)

Set screw hubs

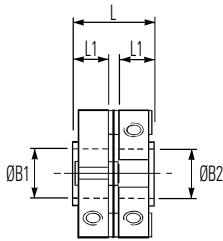

Ref. 460
for use in pairs or with floating shafts

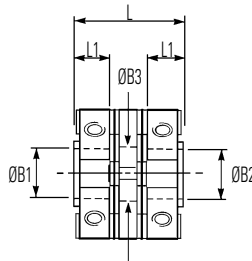

Ref. 464
for precisely aligned shafts

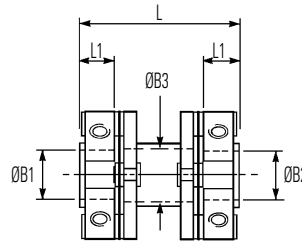

Ref. 468
for greater radial misalignment and lower bearing loads

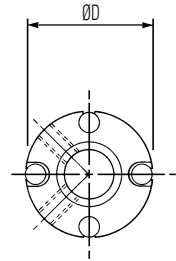

Typical

Clamp hubs

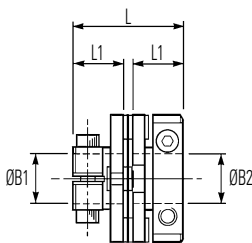

Ref. 462
for use in pairs or with floating shafts

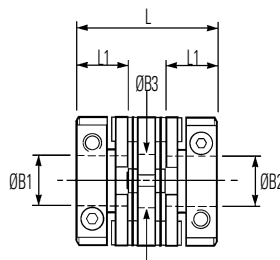

Ref. 466
for precisely aligned shafts

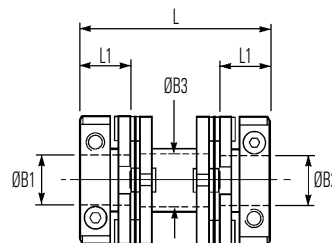

Ref. 470
for greater radial misalignment and lower bearing loads

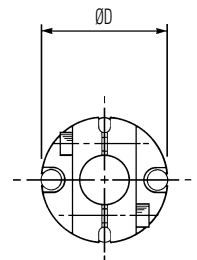

Typical

Drive shafts

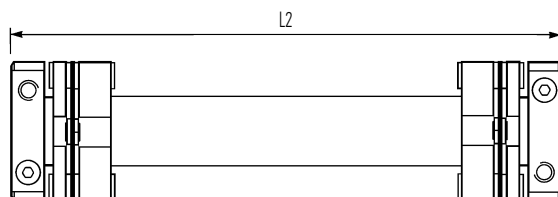

Unless specified otherwise, drive shafts are supplied with set screw hubs inboard.

Drive shafts are supplied to order.

Please specify:

- Coupling size
- Hub style and bore diameter at each end
- Keyway details
- Overall length L2
- Minimum torsional stiffness, if critical
- Quantity

Flexible Membrane Couplings - Rivetted Series

DIMENSIONS & ORDER CODES

Coupling Size	Set Screw Hubs	Clamp Hubs	ØD in. (mm)	L in. (mm)	① L1 in. (mm)	ØB1, ØB2 max in. (mm)	② ØB3 in. (mm)	Fasteners		④ Moment of inertia kgm ² x 10 ⁻⁸	④ Mass kg x 10 ⁻³	
								Screw	③ Torque lb-in. (Nm)			Wrench in. (mm)
COUPLING REF												
19	460.19	—	0.76 (19.2)	0.51 (13.0)	0.22 (5.6)	.25 (6.35)	N/A	M3	8.32 (0.94)	0.06 (1.5)	30	7
	464.19	—		0.77 (19.6)			0.29 (7.3)				50	10
	468.19	—		1.07 (27.3)			N/A				60	12
	—	462.19	0.80 (20.2)	0.29 (7.3)	40		9					
	—	466.19	1.06 (26.8)	N/A	60		13					
	—	470.19	1.36 (34.5)	0.29 (7.3)	60		14					
26	460.26	—	1.00 (25.6)	0.62 (15.8)	0.27 (6.9)	0.39 (10)	N/A	M4	20.0 (2.27)	0.08 (2)	120	15
	464.26	—		0.88 (22.4)			0.43 (11.0)				160	18
	468.26	—		1.19 (30.1)			N/A				200	23
	—	462.26	0.86 (21.8)	0.43 (11.0)	130		16					
	—	466.26	1.12 (28.4)	0.43 (11.0)	160		20					
	—	470.26	1.42 (36.1)	0.43 (11.0)	210		25					
33	460.33	—	1.32 (33.5)	0.89 (22.5)	0.40 (10.0)	0.50 (12.7)	N/A	M5	40.8 (4.62)	0.10 (2.5)	560	37
	464.33	—		1.26 (32.1)			0.56 (14.1)				800	52
	468.33	—		1.69 (42.8)			N/A				830	55
	—	462.33	1.20 (30.5)	0.56 (14.1)	520		37					
	—	466.33	1.58 (40.1)	0.56 (14.1)	730		51					
	—	470.33	2.00 (50.8)	0.56 (14.1)	760		55					
41	460.41	—	1.63 (41.5)	1.10 (27.1)	0.47 (12.0)	0.63 (16)	N/A	M6	67.4 (7.61)	0.12 (3)	1540	69
	464.41	—		1.52 (38.5)			0.69 (17.5)				2250	97
	468.41	—		1.97 (50.1)			N/A				2450	107
	—	462.41	1.46 (37.1)	0.69 (17.5)	1530		72					
	—	466.41	1.91 (48.5)	0.69 (17.5)	2220		100					
	—	470.41	2.40 (60.1)	0.69 (17.5)	2370		109					

IMPORTANT

Load capacity depends on application conditions: **see page 4** for details

- ① Length of supported thro' bore.
- ② Clearance bore thro' spacer.
- ③ Maximum recommended tightening torque.
- ④ Values apply with max bores.
- ⑤ **Peak torque.** Select a size where Peak Torque exceeds the application torque x service factor. (**see page 4**)
- ⑥ Max. compensation values are mutually exclusive.
- ⑦ Torsional stiffness values apply at 50% peak torque with no misalignment, measured shaft-to-shaft with largest standard bores.
Note that in some vendors' catalogues the given torsional stiffness applies to the membrane stack only, giving rise to a greater value.

PERFORMANCE

Coupling Size	Ref.	⑤ Peak torque lb-in. (Nm)	⑦ Max compensation			⑦ Flexural stiffness			
			Angular deg	Radial in. (mm)	Axial in. (±mm)	Torsional Nm / rad	Angular N / deg	Radial N / mm	Axial N / mm
19	460 & 462	7.97 (0.9)	2	0 (0)	.004 (0.1)	220	0.4	—	—
	464 & 466		4	.001 (0.2)	.001 (0.2)	150	0.25	14	< 7
	468 & 470		4	.016 (0.4)	.001 (0.2)	145	0.3	4	—
26	460 & 462	20.4 (2.3)	2	0 (0)	.004 (0.1)	585	0.75	—	—
	464 & 466		4	.001 (0.2)	.001 (0.2)	385	0.5	37	< 7
	468 & 470		4	.016 (0.4)	.001 (0.2)	400	0.4	7	—
33	460 & 462	49.6 (5.6)	1.5	0 (0)	.004 (0.1)	1560	2	—	—
	464 & 466		3	.001 (0.2)	.004 (0.1)	935	1	48	< 8
	468 & 470		3	.016 (0.4)	.001 (0.2)	980	1.2	13	—
41	460 & 462	100 (11.3)	1	0 (0)	.004 (0.1)	2710	4	—	—
	464 & 466		2	.001 (0.2)	.001 (0.2)	1980	2	100	< 8
	468 & 470		2	.016 (0.4)	.001 (0.2)	2020	2	25	—

STANDARD BORES

Sizes indicated in parenthesis are metric (mm).

Coupling Size	ØB1, ØB2 +0.0012/ -0 (+0.03mm/-0mm)																	
	(3)	1/8"	(4)	3/16"	(5)	(6)	1/4"	(8)	(9)	3/8"	(10)	(11)	(12)	1/2"	(14)	(15)	5/8"	(16)
19	•	•	•	•	•	•	•	•	•	•	•	•	•	•	•	•	•	•
26			•	•	•	•	•	•	•	•	•	•	•	•	•	•	•	•
33						•	•	•	•	•	•	•	•	•	•	•	•	•
41							•	•	•	•	•	•	•	•	•	•	•	•
Bore ref.	14	16	18	19	20	22	24	28	30	31	32	33	35	36	38	40	41	42
Corresponding bore adaptor					251		253	255			257			259				260

Diameters for which a bore adaptor is shown can be adapted to smaller shaft sizes. See page 58 for details of metal bore adaptors.

Flexible Membrane Couplings - Bolted Series

Materials & Finishes

- Hubs & spacer:** Al. Alloy 2014A T6
Clear anodised finish
- Membranes:** Spring quality stainless steel
Heat treated
- Bolt assembly:** Bolt, alloy steel, black oiled finish
Bush assembly, steel, zinc plate & black chromate
Safety washer, carbon steel, black/brown oiled finish
- Fasteners:** Alloy steel, black oiled



Temperature Range

-40°F to + 248°F (-40°C to +120°C)

Set screw hubs

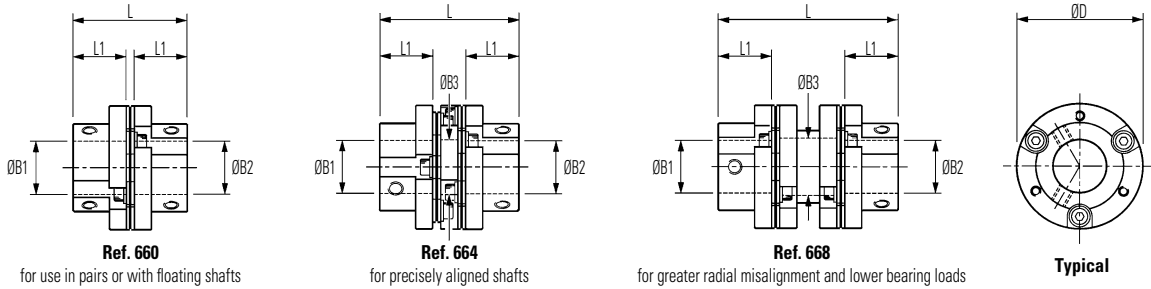

Clamp hubs

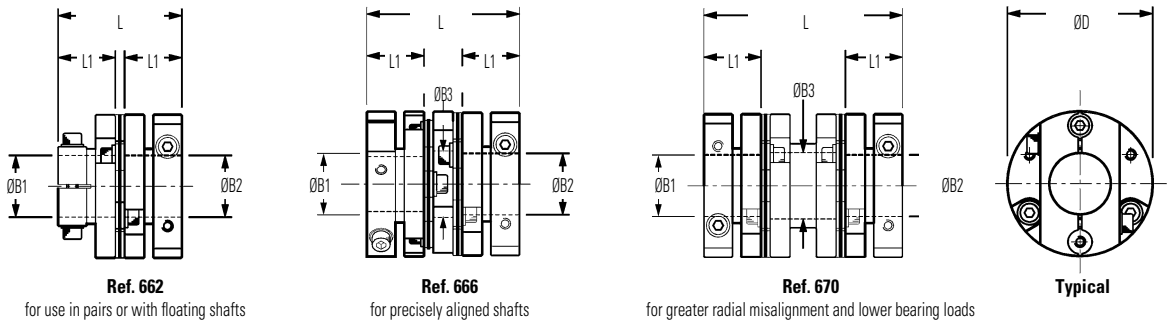

Drive shafts

Unless specified otherwise, drive shafts are supplied with set screw hubs inboard and/or bonded to link shaft.

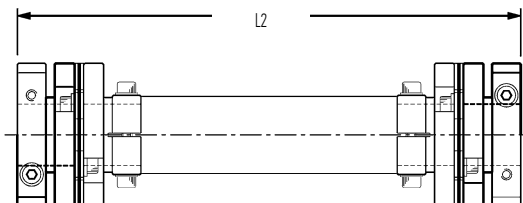

Drive shafts are supplied to order.

Please specify: • Coupling size • Hub style and bore diameter at each end • Keyway details • Overall length L2 • Minimum torsional stiffness, if critical • Quantity

Flexible Membrane Couplings - Bolted Series

DIMENSIONS & ORDER CODES

Coupling Size	Set Screw Hubs	Clamp Hubs	ØD in. (mm)	L in. (mm)	L1 ^① in. (mm)	ØB1, ØB2 max in. (mm)	ØB3 in. (mm)	Fasteners			Moment of inertia ^④ kgm ² x 10-8	Mass ^④ kg x 10-3
								Screw	Torque ^③ lb.-in. (Nm)	Wrench in. (mm)		
COUPLING REF												
41	660.41	–	1.63 (41.5)	1.45 (36.9)	0.67 (17.1)	0.63 (16)	N/A	M6	67.3 (7.60)	0.12 (3)	1160	63
	664.41	–		1.89 (47.9)			0.66 (16.8)				1680	90
	668.41	–		2.35 (59.7)			0.69 (17.5)				1790	101
	–	662.41		1.45 (36.9)			N/A	M4	50.1 (5.66)	0.12 (3)	1400	74
	–	666.41		1.89 (47.9)			0.66 (16.8)				2010	101
	–	670.41		2.35 (59.7)			0.69 (17.5)				2250	112
52	660.52	–	2.05 (52.0)	1.74 (44.2)	0.79 (20.0)	0.79 (20)	N/A	M6	0.86 (7.60)	0.12 (3)	3740	124
	664.52	–		2.17 (55.0)			0.87 (22.0)				5490	168
	668.52	–		2.85 (72.4)			N/A				M5	101 (11.4)
	–	662.52		1.97 (50.0)			N/A	5660	164			
	–	666.52		2.39 (60.8)			0.87 (22.0)	7470	208			
	–	670.52		3.07 (78.1)			0.87 (22.0)	8870	247			
66	660.66	–	2.60 (66.0)	2.38 (60.4)	1.10 (28.0)	1.10 (28)	N/A	M8	162 (18.3)	0.16 (4)	13370	272
	664.66	–		2.90 (73.6)			1.13 (28.7)				18040	360
	668.66	–		3.73 (94.7)			1.19 (30.2)				23400	447
	–	662.66		2.22 (56.4)			N/A	M5	101 (11.4)	0.16 (4)	14200	269
	–	666.66		2.74 (69.6)			1.13 (28.7)				19300	357
	–	670.66		3.57 (90.7)			1.19 (30.2)				24320	444
76	–	662.76	2.99 (76.0)	3.20 (81.2)	1.50 (38.0)	1.50 (38)	N/A	M8	354 (40.0)	0.24 (6)	45658	529
	–	670.76		4.98 (126.4)			1.54 (39)				69823	804

IMPORTANT

Load capacity depends on application conditions: **see page 4** for details

- ① Length of supported thro' bore.
 - ② Clearance bore thro' spacer.
 - ③ Maximum recommended tightening torque.
 - ④ Values apply with max bores.
 - ⑤ **Peak torque.** Select a size where Peak Torque exceeds the application torque x service factor. (**see page 4**)
 - ⑥ Max. compensation values are mutually exclusive.
 - ⑦ Torsional stiffness values apply at 50% peak torque with no misalignment, measured shaft-to-shaft with largest standard bores.
Note that in some vendors' catalogues the given torsional stiffness applies to the membrane stack only, giving rise to a greater value.
- Note that the drawings on the facing page represent Size 66 & 76 which employ 6-bolt membrane Sizes 41 & 52 employ 4-bolts*

PERFORMANCE

Coupling Size	Ref.	⑤ Peak torque lb.-in. (Nm)	⑥ Max compensation			⑦ Flexural stiffness			
			Angular deg	Radial in. (mm)	Axial in. (± mm)	Torsional Nm / rad x 10-3	Angular N / deg	Radial N / mm	Axial N / mm
41	660 & 662	100 (11.3)	1	0 (0)	.004 (0.1)	4.0	3.7	–	< 8
	664 & 666		2	.008 (0.2)	.001 (0.2)	2.8	1.6	97	
	668 & 670		2	.016 (0.4)	.001 (0.2)	2.6	1.6	23	
52	660 & 662	265 (30)	1	0 (0)	.004 (0.1)	7.5	10.0	–	< 9
	664 & 666		2	.008 (0.2)	.001 (0.2)	4.8	5.0	313	
	668 & 670		2	.016 (0.4)	.001 (0.2)	4.8	5.0	57	
66	660 & 662	531 (60)	1	0 (0)	.004 (0.1)	19.0	84.0	–	< 9
	664 & 666		2	.008 (0.2)	.001 (0.2)	12.0	23.0	379	
	668 & 670		2	.016 (0.4)	.001 (0.2)	12.0	23.0	93	
76	662	885 (100)	0.5	0 (0)	.004 (0.1)	45.7	178	–	< 9
	670		1	.016 (0.4)	.001 (0.2)	31	134	110	

STANDARD BORES⁸

Sizes indicated in parenthesis are metric (mm).

Coupling Size	ØB1, ØB2 +0.0012/-0 (+0.03mm/-0mm)																			
	1/4"	(8)	(9)	3/8"	(10)	(11)	(12)	1/2"	(14)	(15)	5/8"	(16)	(18)	(19)	3/4"	(20)	(24)	(25)	1"	(28)
41	•	•	•	•	•	•	•	•	•	•	•	•								
52		•	•	•	•	•	•	•	•	•	•	•	•	•	•	•				
66							•	•	•	•	•	•	•	•	•	•	•	•	•	•
76	----- MANUFACTURED TO ORDER ONLY. PLEASE ENQUIRE -----																			
Bore ref.	24	28	30	31	32	33	35	36	38	40	41	42	45	46	47	48	51	52	53	54
Corresponding bore adaptor	253	255			257			259					260			261				

Diameters for which a bore adaptor is shown can be adapted to smaller shaft sizes. See *page 58* for details of metal bore adaptors.



General Purpose Motion Control Couplings

- Sliding Disc (Oldham)
- Universal Lateral (Uni-Lat)
 - Backlash-free up to 10° turns
 - Can tolerate large misalignments
 - Slight damping characteristics
 - Flex-free mechanical action - non-progressive bearing loads
 - Non-magnetic (with special screws)
 - Electrically isolating
 - Low inertia

Uni-Lats are widely used for pulse generator drives while Oldhams are very popular for stepper driven positioning stages.

A unique property of Uni-Lats is resistance to axial motion. This makes them suitable for light push/pull duties and for anchoring axially unrestricted shafts.

Oldhams are 3-part couplings consisting of 2 hubs + 1 torque disc. The hubs determine the method of installation and shaft attachment, the discs determine the quality of motion.

The 4 hub styles and 2 disc materials that comprise the range are fully interchangeable within each of the 9 sizes available. To take advantage of this flexibility, hubs and discs are specified and supplied separately.

The discs are the sacrificial elements and are replaceable at low cost in the event of wear or breakage.



Lateral Offset Couplings



General Performance Criteria

Temperature Range

-20°F to +140°F (-20°C to +60°C)

Maximum Rotational Speed

3000 rev/min

- ① **Blind hubs:** Length of parallel bore ± 0.2 . Bores may terminate in 118° incl. angle or flat bottomed.
Thro' hubs: Max permissible hub penetration.

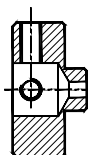

118° Included Angle

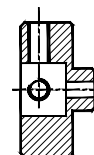

Flat Bottomed

- ② **Blind hubs:** Nominal distance between unchamfered shafts bottomed out to L1.
Thro' hubs: Nominal distance between shafts with standard (unbored) disc.
- ③ Maximum recommended tightening torque.
- ④ Values apply to complete couplings with max bores.
- ⑤ **Peak torque.** Select a size where Peak Torque exceeds the application torque x service factor.
- ⑥ Couplings can provide up to ($\text{ØD} \times 0.1$) radial compensation in extreme cases.
Observe given values for maximum backlash-free life.
Axial compensation is set on installation.
Electrical isolation between shafts > 3kV.
- ⑦ Values apply at 50% peak torque with no misalignment, measured shaft-to-shaft with largest standard bores.
- ⑧ Thro' hubs can be provided with keyways.

Blank hubs

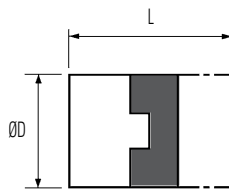

User-adaptable for special needs, e.g. fitting within tubes. Blank hubs are supplied centred with no provision for fastening. External dimensions identical with blind hubs.

Coupling size	Complete hub ref.	ØD	L
06	231.06.00	0.25 (6.4)	0.50 (12.7)
09	231.09.00	0.37 (9.5)	0.50 (12.7)
13	231.13.00	0.50 (12.7)	0.63 (15.9)
19	231.19.00	0.75 (19.1)	0.87 (22.0)
25	231.25.00	1.00 (25.4)	1.12 (28.4)
33	231.33.00	1.31 (33.3)	1.65 (42.0)
41	231.41.00	1.63 (41.3)	2.00 (50.8)

Standard discs (larger sizes are webbed)



- Acetal – High torsional stiffness, good bearing properties, long backlash-free life.
- Nylon 11 – Resilient, isolates noise & vibration. Performance approximately 25% that of acetal disc.

Thro' bored discs



Thro' bored discs allow shafts to near-butt, standard thro' hole diameter = $\text{ØD} \times 0.5$. To order, add suffix 'T' to order code, eg., **236.25T**
Other thro' hole diameters are manufactured to order. Specify the disc ref. and thro' hole diameter. This should equal the larger shaft diameter + 2 x max radial error.

Note that thro' bored discs reduce torsional stiffness.

Brass / Aluminium Blind Hubs

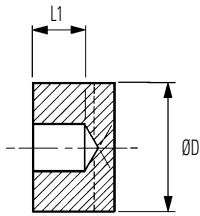

Controlled bore depth L1 provides a register when pre-assembling hubs to shafts

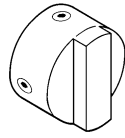

Set screw style



Clamp style

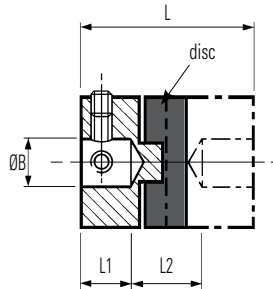

Refs. 232
Set screw style

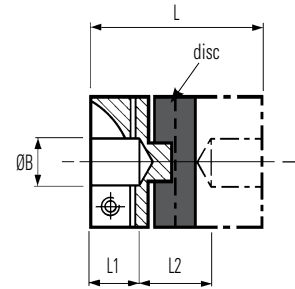

Refs. 234
Clamp style

DIMENSIONS & ORDER CODES

Coupling Type and Size	Hub Ref		Dimensions								Fasteners			Disc Ref	
	Set Screw Style	Clamp Style	ØD in. (mm)	L in. (mm)	① L1 in. (mm)	② L2 in. (mm)	ØB1 Max in. (mm)	④ Moment of Inertia kgm ² x10 ⁻⁸	④ Mass kg x10 ⁻³	Size	③ Torque lb.-in (Nm)	Wrench in. (mm)	Acetal (black) Std.	Nylon 11 (Natural)	
Blind Hubs	06	232.06	-	.25 (6.4)	0.5 (12.7)	0.15 (3.8)	0.20 (5.1)	0.13 (3.18)	6	2.5	M3	8.32 (0.94)	0.06 (1.5)	236.06	238.06
	09	232.09	-	.37 (9.50)	0.5 (12.7)	0.15 (3.8)	0.20 (5.1)	0.20 (5)	18	4	M3	8.32 (0.94)	0.06 (1.5)	236.09	238.09
	13	232.13	-	0.5 (12.7)	0.63 (15.9)	0.17 (4.3)	0.29 (7.3)	0.25 (6.35)	26	11	M3	8.32 (0.94)	0.06 (1.5)	236.13	238.13
	19	232.19	-	.75 (19.1)	0.87 (22.0)	0.25 (6.3)	0.37 (9.4)	0.31 (8)	67	12	M3	8.32 (0.94)	0.06 (1.5)	236.19	238.19
		-	234.19								M2.5	11.6 (1.32)	0.08 (2.0)		
	25	232.25	-	1.0 (25.4)	1.12 (28.4)	0.34 (8.6)	0.44 (11.2)	0.47 (12)	252	31	M4	20.1 (2.27)	0.08 (2.0)	236.25	238.25
		-	234.25								M3	21.5 (2.43)	0.10 (2.5)		
	33	232.33	-	1.31 (3.3)	1.65 (42.0)	0.51 (13.0)	0.63 (16.0)	0.63 (16)	1074	72	M5	40.9 (4.62)	0.06 (1.5)	836.33	838.33
	-	234.33								M4	20.6 (2.33)	0.08 (2.0)			
41	232.41	-	1.62 (41.3)	2.0 (50.8)	0.66 (16.7)	0.69 (17.4)	0.79 (20)	3327	148	M5	40.1 (4.62)	0.10 (2.5)	236.41	238.41	
	-	234.41								M4	50.1 (5.66)	0.12 (3.0)			

PERFORMANCE (AT 20°C WITH STANDARD ACETAL DISC)

Coupling Size	⑤ Peak torque lbs.-in. (Nm)	⑥ Max compensation @ 3000 rpm			⑦ Torsional		Static break torque lbs.-in. (Nm)
		Angular deg	Radial in. (mm)	Axial in. (± mm)	Rate deg / Nm	Stiffness Nm / rad	
06	0.53 (0.06)	0.5	.004 (0.1)	.002 (0.05)	5.7	10	6.2 (0.7)
09	1.90n (0.21)		.004 (0.1)	.002 (0.05)	1.9	30	17.8 (2)
13	4.43 (0.5)		.004 (0.1)	.002 (0.05)	0.88	65	35.4 (4)
19	15.0 (1.7)		.008 (0.2)	.004 (0.1)	0.50	115	70.1 (8)
25	35.4 (4)		.008 (0.2)	.004 (0.1)	0.28	205	115 (13)
33	79.7 (9)		.008 (0.2)	.006 (0.15)	0.093	615	469 (53)
41	151 (17)		.01 (0.25)	.006 (0.15)	0.048	1200	504 (57)

Materials & Finishes

- Hubs sizes 06 to 13 :** Brass Cu Zn 21 Si 3P (Lead Free)
- Hub sizes 19 to 41:** Al Alloy 2014 16
- Fasteners:** Alloy steel, black oiled
- Blind & black hubs:** Irridite NCP finish

IMPORTANT

Load capacity depends on application conditions:
see page 4 for details

STANDARD BORES FOR ALL TYPES

Sizes indicated in parenthesis are metric (mm).

Coupling Size	ØB1, ØB2 +0.0012/ -0 (+0.03mm/-0mm)																													
	(2)	(3)	1/8"	(4)	3/16"	(5)	(6)	1/4"	(8)	3/8"	(10)	(12)	1/2"	(14)	(15)	5/8"	(16)	(18)	(19)	3/4"	(20)	(24)	(25)	(30)						
06	•	•	•																											
09		•	•	•	•	•																								
13		•	•	•	•	•	•	•																						
19				•	•	•	•	•	•																					
25							•	•	•	•	•	•	•	•	•	•	•	•	•	•	•	•	•	•	•					
33										•	•	•	•	•	•	•	•	•	•	•	•	•	•	•	•					
41										•	•	•	•	•	•	•	•	•	•	•	•	•	•	•	•					
Bore ref.	11	14	16	18	19	20	22	24	28	31	32	35	36	38	40	41	42	45	46	47	48	51	52	56						

Aluminium Thro' Hubs

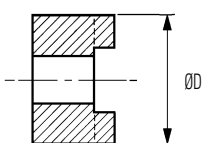

Thro' bores allow disc replacement without disturbing shaft alignment

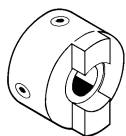

Set screw style

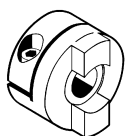

Clamp style

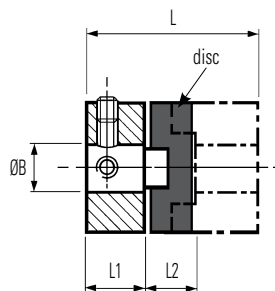

Refs. 450
Set screw style

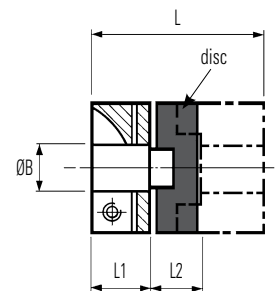

Refs. 452
Clamp style

DIMENSIONS & ORDER CODES

Coupling Type and Size	Hub Ref		Dimensions								Fasteners			Disc Ref	
	Set Screw Style	Clamp Style	ØD in. (mm)	L in. (mm)	① L1 in. (mm)	② L2 in. (mm)	ØB1 Max in. (mm)	④ Moment of Inertia kgm ² x10 ⁻⁸	④ Mass kg x10 ⁻³	Size	③ Torque lb.-in (Nm)	Wrench in. (mm)	Acetal (black) Std.	Nylon 11 (Natural)	
Thro' Hubs	13	450H13	-	0.5 (12.7)	0.63 (15.9)	0.21 (5.5)	0.08 (1.7)	0.25 (6.35)	20	10	M3	8.32 (0.94)	0.06 (1.5)	236.13	238.13
	19	450H19	-	.75 (19.1)	1.02 (26.0)	0.37 (9.4)	0.28 (7.2)	0.31 (8)	59	13	M4	20 (2.27)	0.08 (2.0)	236.19	238.19
		-	452H19								M2.5	11.6 (1.32)	0.08 (2.0)		
	25	450H25	-	1.0 (25.4)	1.28 (32.4)	0.46 (11.6)	0.36 (9.2)	0.47 (12)	252	31	M5	40.9 (4.62)	0.10 (2.5)	236.25	238.25
		-	452H25								M3	21.5 (2.43)	0.10 (2.5)		
	33	450H33	-	1.31 (33.3)	1.65 (42.0)	0.59 (15.0)	0.47 (12.0)	0.63 (16)	1080	67	M6	67.4 (7.61)	0.12 (3.0)	836.33	838.33
		-	452H33								M4	50.1 (5.66)	0.12 (3.0)		
	41	450H41	-	1.62 (41.3)	2.0 (50.8)	0.70 (17.8)	0.60 (15.3)	0.79 (20)	3177	142	M6	67.4 (7.61)	0.12 (3.0)	236.41	238.41
-		452H41	M4								50.1 (5.66)	0.12 (3.0)			
50	450H50	-	1.97 (50.0)	2.35 (59.6)	0.81 (20.6)	0.72 (18.4)	1.0 (25.4)	7550	208	M8	162 (18.36)	0.16 (4.0)	236.50	-	
	-	452H50								M5	101 (11.40)	0.16 (4.0)			
57	450H57	-	2.25 (57.1)	3.07 (78.0)	1.12 (28.4)	0.83 (21.2)	1.18 (30)	12410	361	M8	162 (18.36)	0.16 (4.0)	236.57	-	
	-	452H57								M6	171 (19.34)	0.20 (5.0)			

PERFORMANCE (AT 20°C WITH STANDARD ACETAL DISC)

Coupling Size	⑤ Peak torque lbs.-in. (Nm)	⑥ Max compensation @ 3000 rpm			⑦ Torsional		Static break torque lbs.-in. (Nm)
		Angular deg	Radial in. (mm)	Axial in. (± mm)	Rate deg / Nm	Stiffness Nm / rad	
13	4.43 (0.5)	0.5	.004 (0.1)	.002 (0.05)	0.88	65	35.4 (4)
19	15.0 (1.7)		.008 (0.2)	.004 (0.1)	0.50	115	70.1 (8)
25	35.4 (4)		.008 (0.2)	.004 (0.1)	0.28	205	115 (13)
33	79.7 (9)		.008 (0.2)	.006 (0.15)	0.093	615	469 (53)
41	151 (17)		.01 (0.25)	.006 (0.15)	0.048	1200	504 (57)
50	266 (30)		.01 (0.25)	.008 (0.2)	0.042	1375	841 (95)
57	389 (44)		.01 (0.25)	.008 (0.2)	0.022	2610	1328 (150)

Materials Finishes

Hub sizes 13 to 57 : Al Alloy 2014A 16

Fasteners: Alloy steel, black oxid

Hubs: Clear anodised finish

IMPORTANT

Load capacity depends on application conditions:
see page 4 for details

STANDARD BORES® FOR ALL TYPES

Sizes indicated in parenthesis are metric (mm).

Coupling Size	ØB1, ØB2 +0.0012/ -0 (+0.03mm/-0mm)																								
	(2)	(3)	1/8"	(4)	3/16"	(5)	(6)	1/4"	(8)	3/8"	(10)	(12)	1/2"	(14)	(15)	5/8"	(16)	(18)	(19)	3/4"	(20)	(24)	(25)	(30)	
13		•	•	•	•	•	•	•																	
19				•	•	•	•	•																	
25							•	•																	
33									•	•	•	•	•	•	•	•	•								
41										•	•	•	•	•	•	•	•	•	•	•	•	•	•	•	•
50											•	•	•	•	•	•	•	•	•	•	•	•	•	•	•
57												•	•	•	•	•	•	•	•	•	•	•	•	•	•
Bore ref.	11	14	16	18	19	20	22	24	28	31	32	35	36	38	40	41	42	45	46	47	48	51	52	56	

Stainless Steel Thro' Hubs

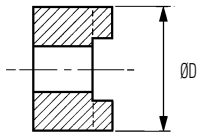

Thro' bores allow disc replacement without disturbing shaft alignment

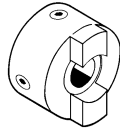

Set screw style

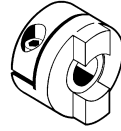

Clamp style

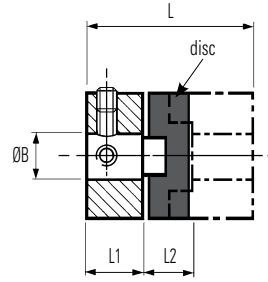

Ref. 850
Set screw style

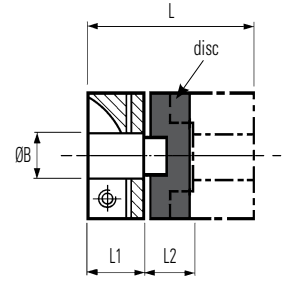

Ref. 852
Clamp style

DIMENSIONS & ORDER CODES

Size	Hub Ref		Dimensions							Moment of Inertia kgm ² x10 ⁻⁸	Mass kg x10 ⁻³	Fasteners			Disc Ref	
	Set Screw Style	Clamp Style	ØD in. (mm)	L in. (mm)	L1 in. (mm)	L2 in. (mm)	ØB1 Max in. (mm)	Size	Torque lbs.-in. (Nm)			A/F in. (mm)	Acetal (black) Std.	Nylon 11 (Nat)		
13	850.13	-	0.5 (12.7)	0.63 (15.9)	0.21 (5.5)	0.08 (1.7)	0.25 (6.35)	26	14	M3	2.83 (0.32)	0.06 (1.5)	236.13	238.13		
19	850.19	-	0.75 (19.1)	1.02 (26.0)	0.37 (9.4)	0.28 (7.2)	0.31 (8.0)	220	45	M4	9.3 (1.05)	0.08 (2.0)	236.19	238.19		
	-	852.19								M2.5	6.0 (0.68)	0.08 (2.0)				
25	850.25	-	1.0 (25.4)	1.28 (32.4)	0.46 (11.6)	0.36 (9.2)	0.47 (12.0)	587	76	M5	18.6 (2.1)	0.10 (2.5)	236.25	238.25		
	-	852.25								M3	10.6 (1.2)	0.10 (2.5)				
33	850.33	-	1.31 (33.3)	1.65 (42.0)	0.60 (15.0)	0.36 (12.0)	0.63 (16.0)	2091	165	M6	33.6 (3.8)	0.12 (3.0)	836.33	838.33		
	-	852.33								M4	25.7 (2.9)	0.12 (3.0)				
41	850.41	-	1.63 (41.3)	2.0 (50.8)	0.70 (17.8)	0.6 (15.3)	0.79 (20.0)	6822	305	M6	33.6 (3.8)	0.12 (3.0)	236.41	238.41		
	-	852.41								M5	52.2 (5.9)	0.16 (4.0)				
50	850.50	-	1.97 (50.0)	2.35 (59.6)	0.81 (20.6)	0.81 (20.6)	1.0 (25.4)	17368	510	M8	79.7 (9.0)	0.16 (4.0)	236.50	N/A		
	-	852.50								M6	86.7 (9.8)	0.20 (5.0)				

PERFORMANCE (AT 20°C WITH STANDARD ACETAL DISC)

Coupling Size	⑤ Peak torque lbs.-in. (Nm)	⑥ Max compensation @ 3000 rpm			⑦ Torsional		Static break torque lbs.-in. (Nm)
		Angular deg	Radial in. (mm)	Axial in. (± mm)	Rate deg / Nm	Stiffness Nm / rad	
13	4.43 (0.5)	0.5	.004 (0.1)	.002 (0.05)	0.88	65	35.4 (4)
19	15.0 (1.7)		.008 (0.2)	.004 (0.1)	0.50	115	70.1 (8)
25	35.4 (4)		.008 (0.2)	.004 (0.1)	0.28	205	115 (13)
33	79.7 (9)		.008 (0.2)	.006 (0.15)	0.093	615	469 (53)
41	151 (17)		.01 (0.25)	.006 (0.15)	0.048	1200	504 (57)
50	266 (30)		.01 (0.25)	.008 (0.2)	0.042	1375	841 (95)

Materials Finishes

Hubs: Stainless Steel 303 S31

- Natural Finish

Fasteners: Stainless Steel

IMPORTANT

Load capacity depends on application conditions:
see page 4 for details

STANDARD BORES® FOR ALL TYPES

Sizes indicated in parenthesis are metric (mm).

Coupling Size	ØB1, ØB2 +0.0012/ -0 (+0.03mm/-0mm)																											
	(2)	(3)	1/8"	(4)	3/16"	(5)	(6)	1/4"	(8)	3/8"	(10)	(12)	1/2"	(14)	(15)	5/8"	(16)	(18)	(19)	3/4"	(20)	(24)	(25)	(30)				
13		•	•	•	•	•	•	•																				
19				•	•	•	•	•																				
25						•	•	•	•	•	•	•																
33								•	•	•	•	•	•	•	•	•	•											
41									•	•	•	•	•	•	•	•	•	•	•	•	•	•	•	•	•			
50										•	•	•	•	•	•	•	•	•	•	•	•	•	•	•	•			
Bore ref.	11	14	16	18	19	20	22	24	28	31	32	35	36	38	40	41	42	45	46	47	48	51	52	56				

Universal / Lateral Offset Couplings



Materials & Finishes

- Hub sizes 18 & 27:** Brass BS CZ121
- Hub sizes 34, 41 & 70:** Al. Alloy 2014 T6
Irridite NCP
- Fasteners:** Alloy steel, black oiled
- Clamp rings (sizes 18 & 27):** Al. Alloy 2014 T6
Irridite NCP
- Torque rings, all sizes:** Acetal (black)

Temperature Range

-20°F to +140°F (-20°C to +60°C)

Set screw hubs

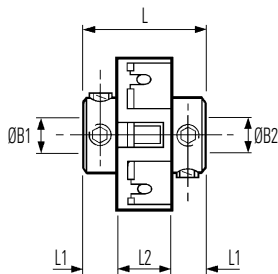

Ref. 201
Small bores

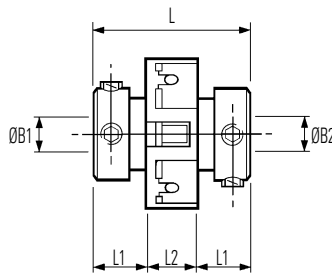

Ref. 203
Large bores

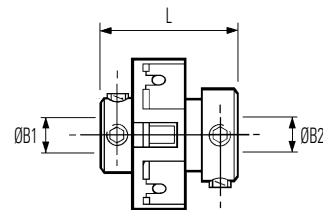

Ref. 221 (not listed in main table).
Combines large & small bores.
See explanatory note on facing page

Coupling ref. 221	
Size	L in. (mm)
18	0.66 (16.7)
27	0.88 (22.3)
34	1.10 (28.0)
41	1.31 (33.3)

Clamp hubs

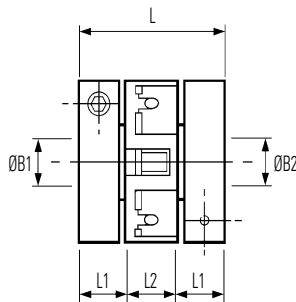

Ref. 207
Collet hub & ring clamp

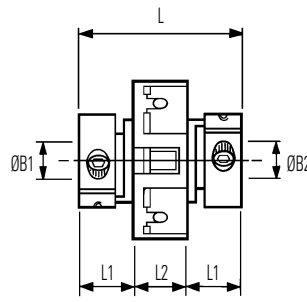

Ref. 205
Integral leaf clamp

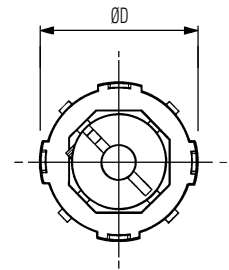

Typical

Installation

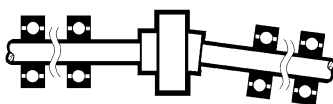

right

Up to 10° angular offset,
depending on type

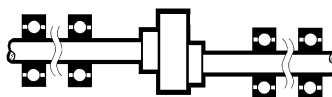

right

Up to 1mm radial offset for
extreme misalignments

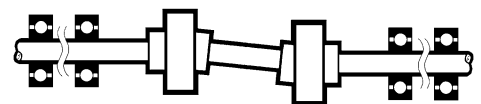

wrong

Standard Uni-Lats cannot be used in pairs.
Special versions are available for use in this mode.
Please enquire.

Universal / Lateral Offset Couplings

DIMENSIONS & ORDER CODES

Coupling Size	Set Screw Hubs	Clamp Hubs	ØD in. (mm)	L in. (mm)	① L1 in. (mm)	② L2 in. (mm)	ØB1, ØB2 max in. (mm)	Fasteners			④ Moment of inertia kgm ² x 10 ⁻⁸	④ Mass kg x 10 ⁻³
								Screw	③ Torque lb.-in. (Nm)	Wrench in. (mm)		
COUPLING REF												
18	201.18	–	.71 (18.0)	.56 (14.2)	.18 (4.6)	0.20 (5.1)	0.20 (5)	M3	8.32 (0.94)	0.06 (1.5)	20	7
	203.18	–	.75 (19.1)	.28 (7.0)	0.20 (5.1)	0.25 (6.35)	M2.5	11.6 (1.32)	0.08 (2.0)	55	11	
	–	207.18 ± 218	0.75 (19.1)	–	–	–	–	–	–	–	–	–
27	201.27	–	1.10 (28.0)	.75 (19.1)	0.24 (6.1)	0.27 (6.9)	0.31 (8)	M3	8.32 (0.94)	0.06 (1.5)	91	16
	203.27	–	1.0 (25.4)	0.37 (9.3)	0.27 (6.9)	0.39 (10)	M3	21.5 (2.43)	0.10 (2.5)	220	26	
	–	207.27 ± 218	–	–	–	–	–	–	–	–	–	–
34	201.34	–	1.33 (33.7)	.99 (25.2)	0.32 (8.1)	0.35 (8.9)	0.38 (10)	M4	20.1 (2.27)	.08 (2.0)	165	17
	203.34	–	1.21 (30.7)	0.43 (10.9)	0.35 (8.9)	0.5 (12.7)	M2.5	11.6 (1.32)	0.10 (2.5)	183	20	
	–	205.34	–	–	–	–	–	–	–	–	–	–
41	201.41	–	1.63 (41.4)	1.12 (28.4)	0.34 (8.6)	0.44 (11.2)	0.5 (12.7)	M4	20.1 (2.27)	.08 (2.0)	476	30
	203.41	–	1.5 (38.1)	0.53 (13.5)	0.44 (11.2)	0.63 (16)	M5	40.9 (4.62)	0.10 (2.5)	550	40	
	–	205.41	–	–	–	–	–	–	–	–	–	–
70	203.70	–	1.14 (69.0)	2.91 (74.0)	1.12 (28.5)	0.67 (17.0)	0.87 (22)	M6	67 (7.60)	0.12 (3.0)	7315	189
	–	205.70	–	–	–	–	0.87 (22)	M6	170 (19.3)	0.20 (5.0)	7315	189

- ① Length of supported thro' bore. Shafts must not penetrate beyond L1 when in operation.
- ② Nominal distance between shafts inserted to L1.
- ③ Maximum recommended tightening torque.
- ④ Values apply with max bores.
- ⑤ *Peak torque*. Select a size where Peak Torque exceeds the application torque x service factor. (**see page 4**)
- ⑥ Couplings can provide up to 1mm radial and 10° angular compensation (5° for ref. 207) when required. Observe given values for maximum backlash-free life. Electrical isolation between shafts > 3kV for all models when offset ≤5°.
- ⑦ Values apply at 50% peak torque with no misalignment, measured shaft-to-shaft with largest standard bores.

‡ Ref. 207 only. Insert both bore codes in place of ‡.

PERFORMANCE AT 20°C

Coupling Size	⑤ Peak torque lb.-in. (Nm)	⑥ Max compensation @ 3000 rpm		⑦ Torsional		Axial		Static break torque lb.-in. (Nm)
		Angular deg	Radial in. (mm)	Rate deg / Nm	Stiffness Nm / rad	Max loading ±N	Stiffness N / mm	
18	2.66 (0.3)	2	.008 (0.2)	2.3	25	19	155	7.97 (0.9)
27	15.1 (1.7)		.008 (0.2)	0.6	92	31	350	44.3 (5.0)
34	22.1 (2.5)		.010 (0.25)	0.4	146	34	300	66.4 (7.5)
41	31.0 (3.5)		.010 (0.25)	0.19	299	39	250	92.9 (10.5)
70	106 (12.0)		.010 (0.25)	0.19	1300	75	540	602 (68)

Coupling ref. 221

By specifying ref. 221 (not listed in tables, see diagram previous page) you can combine the bores coded for ref. 201 with those coded for ref. 203,

eg., 221.27.2432 specifies Size 27 with Ø6.35 x 10 bores.

IMPORTANT

Load capacity depends on application conditions: **see page 4** for details

STANDARD BORES

Sizes indicated in parenthesis are metric (mm).

Coupling		ØB1, ØB2 +0.0012/ -0 (+0.03mm/-0mm)																				
size	ref.	(3)	1/8"	(4)	3/16"	(5)	(6)	1/4"	5/16"	(8)	3/8"	(10)	(12)	1/2"	(14)	5/8"	(16)	(18)	(19)	3/4"	(18)	
18	201.18	•	•	•	•	•																
	203.18						•	•														
	207.18	•	•	•	•	•	•	•	•	•												
27	201.27	•	•	•	•	•	•	•	•	•												
	203.27						•	•	•	•	•	•										
	207.27					•	•	•	•	•	•	•										
34	201.34						•	•		•	•	•										
	203.34												•	•								
	205.34						•	•	•	•	•	•										
41	201.41						•	•		•	•	•										
	203.41															•	•	•				
	205.41						•	•		•	•	•										
70	203.70												•	•	•	•	•	•	•	•	•	•
	205.70												•	•	•	•	•	•	•	•	•	•
Bore ref.		14	16	18	19	20	22	24	27	28	31	32	35	36	38	41	42	45	46	47	48	
Corresponding bore adaptor						251		253		254* 255		257		259			260					261

Diameters for which a bore adaptor is shown can be adapted to smaller shaft sizes. See page 58 for details.

*Note that adaptor 254 is dedicated to coupling ref. 201.27. Use adaptor 255 for all other 8mm diameters.



Beam Couplings

- Multi-Beam
 - Single-Beam
 - Step-Beam
- **Torsionally rigid design**
 - **Zero backlash**
 - **No moving parts**
 - **Single beam simple coupling compatible with industry standard types**
 - **3-Beam single stage for increased torsional stiffness**
 - **6-Beam two stage for torsional stiffness and increased radial compliance**
 - **Step Beam for low inertia, electrical isolation, low cost**

Beam couplings will readily accommodate any combination of axial motion, angular and parallel misalignment.

The 3 start helical-cut design provides higher torque capability and reduced wind-up compared with single beam versions.

Multi-Beam is available in three standard materials: stainless steel, aluminium and acetal, for shaft diameters from 1mm to 38mm.



Multi-Beam

Stainless Steel Multi-Helix Flexible 3 Beam Couplings

Set Screw Hubs

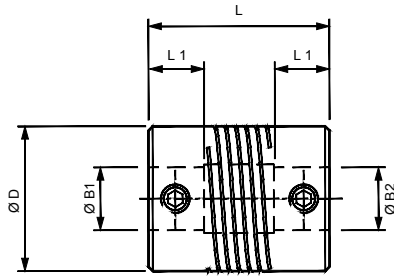

Clamp Hubs

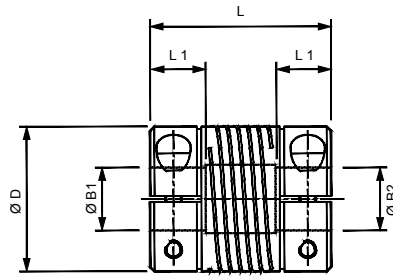

Materials & Finishes

Couplings: Stainless Steel 303 S31

Fasteners: Stainless Steel

Temperature Range

-40°F to +284°F

(-40°C to +140°C)

3-BEAM COUPLINGS: DIMENSIONS & ORDER CODES

Coupling Type & Size	Set Screw Style	Clamp Type	ØD in. (mm)	L in. (mm)	① L1 in. (mm)	Bore Diameters			Mass kgx10-3	Fasteners				② Angular Offset Deg.	② Parallel Offset mm	Torsional Stiffness Nm/rad	③ Peak Torque lb.in (Nm)	
						Min B1	Min B2	Max B1 & B2		Set Screw	Cap Screw	Torque lbs.-in. (Nm)	Wrench in. (mm)					
Relieved	6	720.06	-	.25 (6.4)	.05 (12.7)	.13 (3.2)	1.0	2.0	3.0	1.93	M2	-	0.71 (0.08)	.035 (0.9)	3	.003 (.07)	1.53	3.98 (0.45)
	9	720.09	-	.37 (9.5)	.56 (14.2)	.18 (4.5)	2.0	3.0	3.18	5.85	M2.5	-	2.04 (0.23)	.051 (1.3)	3	.004 (0.1)	16	4.43 (0.50)
		-	721.09	-	-	-	-	-	-	-	-	M1.6	1.33 (0.15)	.059 (1.5)				
	13	720.13	-	0.5 (12.7)	.75 (19.1)	.24 (6.0)	3.0	4.0	5.0	13.7	M3	-	2.83 (0.32)	.059 (1.5)	5	.005 (.127)	54	8.85 (1.0)
		-	721.13	-	-	-	-	-	-	-	-	M2	2.66 (0.30)	.059 (1.5)				
	16	720.16	-	.63 (15.9)	.80 (20.3)	.26 (6.5)	3.0	4.0	6.35	22.9	M4	-	9.29 (1.05)	.079 (2.0)	5	.005 (.127)	81	15.9 (1.80)
		-	721.16	-	-	-	-	-	-	-	-	M2.5	6.02 (0.68)	.079 (2.0)				
	19	720.19	-	.75 (19.1)	.90 (22.9)	.26 (6.5)	4.0	4.76	8.0	35.9	M4	-	9.29 (1.05)	.079 (2.0)	5	.005 (.127)	143	23.9 (2.70)
		-	721.19	-	-	-	-	-	-	-	-	M2.5	6.02 (0.68)	.079 (2.0)				
	25	720.25	-	1.0 (25.4)	1.25 (31.8)	.35 (9.0)	5.0	6.0	10	92.2	M5	-	18.6 (2.10)	.098 (2.5)	5	.005 (.127)	175	53.1 (6.0)
-		721.25	-	-	-	-	-	-	-	-	M3	10.6 (1.20)	.098 (2.5)					
32	720.32	-	1.25 (31.8)	1.75 (44.5)	.47 (12.0)	6.0	8.0	14	194	M6	-	33.2 (3.75)	0.12 (3.0)	5	.005 (.127)	378	88.5 (10.0)	
	-	721.32	-	-	-	-	-	-	-	-	M4	25.2 (2.85)	0.12 (3.0)					

① Length of supported bore.

③ **Peak torque.** Select a size where Peak Torque exceeds the application torque x service factor. (see page 4)

② Max. compensation values are mutually exclusive.

BORE SIZES 3-BEAM COUPLINGS

Sizes indicated in parenthesis are metric (mm).

Coupling Size	ØB1, ØB2 +0.0012/ -0 (+0.03mm/-0mm)														
	(1)	(2)	(3)	1/8"	(4)	3/16"	(5)	(6)	1/4"	(8)	3/8"	(10)	(12)	1/2"	(14)
6	○	●	●												
9		○	●	●											
13			○	○	●	●	●								
16			○	○	●	●	●	●	●						
19					○	●	●	●	●	●					
25						○	●	●	●	●	●	●			
32							○	○	●	●	●	●	●	●	●
Bore ref.	8	11	14	16	18	19	20	22	24	28	31	32	35	36	38

○ B1 only ● B1 & B2

Stainless Steel Multi-Helix Flexible 6 Beam Couplings Non-Relieved

Set Screw Hubs

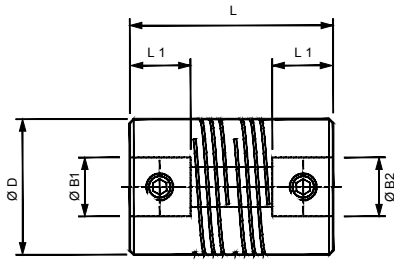

Clamp Hubs

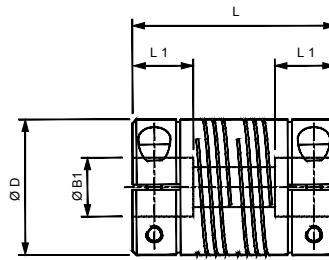

Materials & Finishes

Couplings: Stainless Steel 303 S31

Fasteners: Stainless Steel

Temperature Range

-40°F to +284°F

(-40°C to +140°C)

6-BEAM COUPLINGS: DIMENSIONS & ORDER CODES

Coupling Type & Size	Set Screw Style	Clamp Type	ØD in. (mm)	L in. (mm)	L1 in. (mm)	Bore Diameters			Mass kgx10-3	Fasteners				Angular Offset Deg.	Parallel Offset mm	Torsional Stiffness Nm/rad	Peak Torque lb.in (Nm)
						Min B1	Min B2	Max B1 & B2		Set Screw	Cap Screw	Torque lbs.-in. (Nm)	Wrench in. (mm)				
09	702.09	-	0.4 (9.5)	0.77 (19.6)	0.21 (5.3)	2.0	4.0	4.76	7.0	M2.5	-	2.04 (0.23)	0.51 (1.3)	3.0	.002 (0.12)	5.4	13.3 (1.5)
	-	703.09	-	-	-	-	-	-	-	-	M1.6	1.33 (0.15)	0.59 (1.5)				
13	702.13	-	0.5 (12.7)	1.00 (25.4)	0.26 (6.5)	3.0	5.0	6.35	17.0	M3	-	2.83 (0.32)	0.59 (1.5)	5.0	.007 (0.17)	25	26.6 (3.0)
	-	703.13	-	-	-	-	-	-	-	-	M2	2.66 (0.30)	0.59 (1.5)				
16	702.16	-	0.63 (15.9)	1.00 (25.4)	0.26 (6.5)	3.0	6.0	8.0	28.0	M4	-	9.29 (1.05)	.079 (2.0)	5.0	.008 (0.2)	45	44.2 (5.0)
	-	703.16	-	-	-	-	-	-	-	-	M2.5	6.02 (0.68)	.079 (2.0)				
19	702.19	-	0.75 (19.1)	1.10 (28.0)	0.26 (6.5)	4.76	6.35	10.0	44.0	M4	-	9.29 (1.05)	.079 (2.0)	7.0	0.01 (0.25)	72	70.8 (8.0)
	-	703.19	-	-	-	-	-	-	-	-	M2.5	6.02 (0.68)	.079 (2.0)				
25	702.25	-	1.00 (25.4)	1.50 (38.1)	0.43 (11.0)	5.0	8.0	12.7	109	M5	-	18.6 (2.10)	.098 (2.5)	7.0	.015 (0.38)	170	141.6 (16.0)
	-	703.25	-	-	-	-	-	-	-	-	M3	10.6 (1.20)	.098 (2.5)				
32	702.32	-	1.25 (31.8)	2.25 (57.2)	0.63 (16.0)	8.0	10.0	19.0	262	M6	-	33.2 (3.75)	0.12 (3.0)	7.0	0.02 (0.5)	364	221.3 (25.0)
	-	703.32	-	-	-	-	-	16.0	-	-	M4	25.2 (2.85)	0.12 (3.0)				
38	702.38	-	1.50 (38.1)	2.63 (66.7)	0.71 (18.0)	8.0	12.0	22.0	443	M6	-	33.2 (3.75)	0.12 (3.0)	7.0	.024 (0.6)	634	318.6 (36.0)
	-	703.38	-	-	-	-	-	19.0	-	-	M5	51.8 (5.85)	0.16 (4.0)				
44	702.44	-	1.75 (44.5)	3.00 (76.2)	0.79 (20.0)	9.0	14.0	25.0	687	M6	-	33.2 (3.75)	0.11 (3.0)	7.0	.031 (0.8)	945	424.8 (48.0)
	-	703.44	-	-	-	-	-	22.0	-	-	M5	51.3 (5.80)	0.16 (4.0)				
51	702.51	-	2.00 (50.8)	3.75 (95.3)	0.98 (25.0)	10.0	16.0	28.0	1116	M8	-	80.0 (9.00)	0.16 (4.0)	7.0	0.35 (0.9)	1305	646.1 (73.0)
	-	703.51	-	-	-	-	-	26.0	-	-	M6	86.3 (9.75)	0.20 (5.0)				
57	702.57	-	2.25 (57.2)	5.12 (130)	1.26 (32.0)	10.0	20.0	32.0	1944	M8	-	80.0 (9.00)	0.16 (4.0)	7.0	.037 (0.95)	1755	902.8 (102.0)
	-	703.57	-	-	-	-	-	30.0	-	-	M6	86.3 (9.75)	0.20 (5.0)				
64	702.64	-	2.5 (63.5)	5.91 (150)	1.5 (38.0)	12.0	25.0	38.0	3234	M8	-	80.0 (9.00)	0.16 (4.0)	7.0	0.39 (1.0)	2340	1,239.0 (140.0)
	-	703.64	-	-	-	-	-	36.0	-	-	M8	212 (24.0)	0.24 (6.0)				

① Length of supported bore.

③ **Peak torque.** Select a size where Peak Torque exceeds the application torque x service factor. (see page 4)

② Max. compensation values are mutually exclusive.

BORE SIZES 6-BEAM COUPLINGS, NON-RELIEVED

○ B1 only

● B1 & B2

Sizes indicated in parenthesis are metric (mm).

Coupling Size	ØB1, ØB2 +0.0012/-0 (+0.03mm/-0mm)																												
	(2)	(3)	1/8"	(4)	3/16"	(5)	(6)	1/4"	(8)	3/8"	(10)	(12)	1/2"	(14)	5/8"	(16)	(18)	(19)	3/4"	(20)	(24)	(25)	1"	(28)	(30)	1 1/4"	(32)		
9	○	○	○	●	●																								
13		○	○	○	○	●	●	●																					
16		○	○	○	○	○	●	●	●																				
19					○	○	○	○	○	●	●	●	●																
25						○	○	○	○	○	○	○	○	○	○	○	○												
32										○	○	○	○	○	○	○	○	○	○	○	○	○	○	○	○	○	○	○	○
38										○	○	○	○	○	○	○	○	○	○	○	○	○	○	○	○	○	○	○	○
44											○	○	○	○	○	○	○	○	○	○	○	○	○	○	○	○	○	○	○
51											○	○	○	○	○	○	○	○	○	○	○	○	○	○	○	○	○	○	○
57											○	○	○	○	○	○	○	○	○	○	○	○	○	○	○	○	○	○	○
64											○	○	○	○	○	○	○	○	○	○	○	○	○	○	○	○	○	○	○
Bore ref.	11	14	16	18	19	20	22	24	28	31	32	35	36	38	41	42	45	46	47	48	51	52	53	54	56	57	58		

Multi-Beam

Stainless Steel Multi-Helix Flexible 6 Beam Couplings

Set Screw Hubs

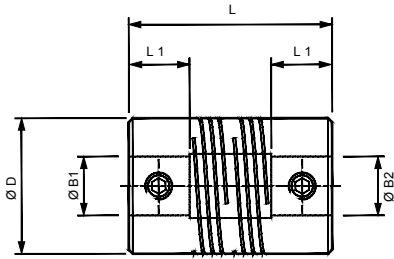

Clamp Hubs

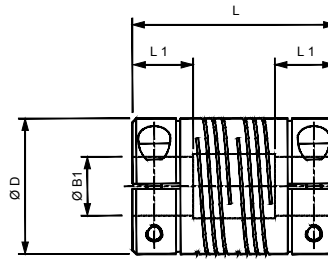

Materials & Finishes

Couplings: Stainless Steel 303 S31

Fasteners: Stainless Steel

Temperature Range

-40°F to +284°F

(-40°C to +140°C)

6-BEAM COUPLINGS: DIMENSIONS & ORDER CODES

Coupling Type & Size	Set Screw Style	Clamp Type	ØD in. (mm)	L in. (mm)	① L1 in. (mm)	Bore Diameters			Mass kgx10-3	Fasteners				② Angular Offset Deg.	② Parallel Offset mm	④ Torsional Stiffness Nm/rad	③ Peak Torque lb.in (Nm)
						Min B1	Min B2	Max B1 & B2		Set Screw	Cap Screw	Torque lbs.-in. (Nm)	Wrench in. (mm)				
Relieved	09	722.09 - 723.09	0.4 (9.5)	0.77 (19.6)	0.21 (5.3)	2.0	3.0	4.76	6.5	M2.5	-	1.77 (0.2)	0.51 (1.3)	3.0	.002 (0.12)	3.2	797 (0.9)
	13	722.13 - 723.13	0.5 (12.7)	1.00 (25.4)	0.26 (6.5)	3.0	4.0	6.35	15.0	M3	-	2.83 (0.32)	0.59 (1.5)	5.0	.007 (0.17)	15.0	16.82 (1.9)
		722.16 - 723.16	0.63 (15.9)	1.00 (25.4)	0.26 (6.5)	3.0	4.0	8	24.0	M4	-	9.29 (1.05)	.079 (2.0)	5.0	.008 (0.2)	27.0	30.09 (3.4)
	19	722.19 - 723.19	0.75 (19.1)	1.10 (28.0)	0.26 (6.5)	4.76	5.0	10	37.0	M4	-	9.29 (1.05)	.079 (2.0)	7.0	0.01 (0.25)	43.0	42.48 (4.8)
		722.25 - 723.25	1.00 (25.4)	1.50 (38.1)	0.43 (11.0)	5.0	6.0	12.7	99.0	M5	-	18.59 (2.10)	.098 (2.5)	7.0	.015 (0.38)	102	88.5 (10.0)
	32	722.32 - 723.32	1.25 (31.8)	2.25 (57.2)	0.63 (16.0)	8.0	9.53	19.0	236	M6	-	33.2 (3.75)	0.12 (3.0)	7.0	0.02 (0.5)	218	115.1 (13.0)
		722.38 - 723.38	1.50 (38.1)	2.63 (66.7)	0.71 (18.0)	8.0	12.0	22.0	400	M6	-	51.8 (5.85)	0.12 (3.0)	7.0	.024 (0.6)	380	117.0 (20.0)
	44	722.44 - 723.44	1.75 (44.5)	3.00 (76.2)	0.79 (20.0)	9.0	14.0	25.0	523	M6	-	33.2 (3.75)	0.11 (3.0)	7.0	.031 (0.8)	567	239.0 (27.0)
		722.51 - 723.51	2.00 (50.8)	3.75 (95.3)	0.98 (25.0)	10.0	16.0	28.0	996	M8	-	80.0 (9.00)	0.16 (4.0)	7.0	0.35 (0.9)	783	327.5 (37.0)
	57	722.57 - 723.57	2.25 (57.2)	5.12 (130)	1.26 (32.0)	10.0	20.0	32.0	1708	M8	-	80.0 (9.00)	0.16 (4.0)	7.0	.037 (0.95)	1053	442.5 (50.0)
		722.64 - 723.64	2.5 (63.5)	5.91 (150)	1.5 (38.0)	12.0	25.0	38.0	2300	M8	-	80.0 (9.00)	0.16 (4.0)	7.0	0.39 (1.0)	1400	757.3 (65.0)

① Length of supported bore.

③ **Peak torque.** Select a size where Peak Torque exceeds the application torque x service factor. (see page 4)

② Max. compensation values are mutually exclusive. ④ Torsional Stiffness values based on maximum bores, for smaller bore combinations the values are nearer the non-relieved type.

BORE SIZES 6-BEAM COUPLINGS, RELIEVED

○ B1 only

● B1 & B2

Sizes indicated in parenthesis are metric (mm).

Coupling Size	ØB1, ØB2 +0.0012/-0 (+0.03mm/-0mm)																															
	(2)	(3)	1/8"	(4)	3/16"	(5)	(6)	1/4"	(8)	3/8"	(10)	(12)	1/2"	(14)	5/8"	(16)	(18)	(19)	3/4"	(20)	(24)	(25)	1"	(28)	(30)	1 1/4"	(32)					
9	○	●	●	●	●																											
13		○	○	●	●	●	●	●																								
16		○	○	●	●	●	●	●	●																							
19					○	●	●	●	●	●																						
25						○	●	●	●	●	●	●	●																			
32									○	●	●	●	●	●	●	●																
38									○	●	●	●	●	●	●	●	●	●	●	●	●											
44										○	○	○	○	○	●	●	●	●	●	●	●	●	●	●	●	●	●	●	●			
51											○	○	○	○	○	○	○	○	○	○	○	○	○	○	○	○	○	○	○			
57												○	○	○	○	○	○	○	○	○	○	○	○	○	○	○	○	○	○			
64													○	○	○	○	○	○	○	○	○	○	○	○	○	○	○	○	○			
Bore ref.	11	14	16	18	19	20	22	24	28	31	32	35	36	38	41	42	45	46	47	48	51	52	53	54	56	57	58					

Aluminium Multi-Helix Flexible 3 Beam Couplings

Set Screw Hubs

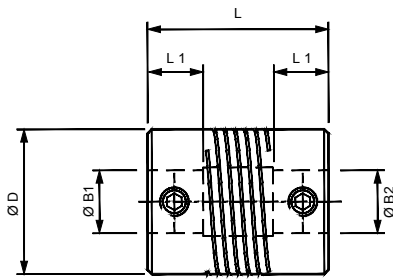

Clamp Hubs

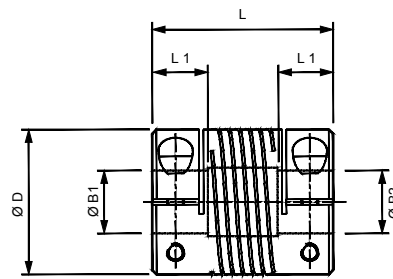

Materials & Finishes

Couplings: Aluminium L168 or better

Fasteners: Alloy steel, black oiled

Temperature Range

-40°F to +284°F

(-40°C to +120°C)

3-BEAM COUPLINGS: DIMENSIONS & ORDER CODES

Coupling Type & Size	Set Screw Style	Clamp Type	ØD in. (mm)	L in. (mm)	① L1 in. (mm)	Bore Diameters			Mass kgx10-3	Fasteners				② Angular Offset Deg.	② Parallel Offset mm	Torsional Stiffness Nm/rad	③ Peak Torque lb.in (Nm)	
						Min B1	Min B2	Max B1 & B2		Set Screw	Cap Screw	Torque lbs.-in. (Nm)	Wrench in. (mm)					
Relieved	6	724.06	-	.25 (6.4)	.05 (12.7)	.13 (3.2)	1.0	2.0	3.0	0.7	M2	-	1.77 (0.2)	.035 (0.9)	3.0	.003 (.07)	1.53	354 (0.40)
	9	724.09	-	.37 (9.5)	.56 (14.2)	.18 (4.5)	2.0	3.0	3.18	2.2	M2.5	-	4.87 (0.55)	.051 (1.3)	3.0	.004 (0.1)	5.4	354.02 (0.40)
		-	725.09	-	.05 (12.7)	.75 (19.1)	.24 (6.0)	3.0	4.0	5.0	5.0	M3	-	8.0 (0.90)				
	13	724.13	-	.63 (15.9)	.80 (20.3)	.26 (6.5)	3.0	4.0	6.35	8.2	M4	-	19.5 (2.2)	.079 (2.0)	5.0	.005 (.127)	38.0	796.57 (0.90)
		-	725.13	-	.75 (19.1)	.90 (22.9)	.26 (6.5)	4.0	4.76	8.0	12.8	-	M2.5	.079 (2.0)				
	16	724.16	-	1.0 (25.4)	1.25 (31.8)	.35 (9.0)	5.0	6.0	10	32.6	M5	-	40.7 (4.6)	.098 (2.5)	5.0	.005 (.127)	121	35.4 (4.0)
		-	725.16	-	1.25 (31.8)	1.75 (44.5)	.47 (12.0)	6.0	8.0	14	70	-	M3	.098 (2.5)				
	19	724.19	-	1.25 (31.8)	1.75 (44.5)	.47 (12.0)	6.0	8.0	14	70	M6	-	67.3 (7.6)	0.12 (3.0)	5.0	.005 (.127)	238	53.1 (8.0)
		-	725.19	-	1.75 (44.5)	2.25 (57.1)	.57 (14.5)	7.0	10.0	18	100	-	M4	0.12 (3.0)				
	25	724.25	-	1.75 (44.5)	2.25 (57.1)	.57 (14.5)	7.0	10.0	18	100	M6	-	67.3 (7.6)	0.12 (3.0)	5.0	.005 (.127)	238	53.1 (8.0)
-		725.25	-	2.25 (57.1)	2.75 (70.1)	.67 (17.0)	8.0	12.0	22	140	-	M4	0.12 (3.0)					
32	724.32	-	2.75 (70.1)	3.25 (82.8)	.77 (19.5)	8.0	12.0	22	140	M6	-	67.3 (7.6)	0.12 (3.0)	5.0	.005 (.127)	238	53.1 (8.0)	
	-	725.32	-	3.25 (82.8)	3.75 (95.3)	.87 (22.1)	9.0	14.0	28	180	-	M4	0.12 (3.0)					

① Length of supported bore.

③ **Peak torque.** Select a size where Peak Torque exceeds the application torque x service factor. (see page 4)

② Max. compensation values are mutually exclusive.

BORE SIZES 3-BEAM COUPLINGS

Sizes indicated in parenthesis are metric (mm).

Coupling Size	ØB1, ØB2 +0.0012/ -0 (+0.03mm/-0mm)														
	(1)	(2)	(3)	1/8"	(4)	3/16"	(5)	(6)	1/4"	(8)	3/8"	(10)	(12)	1/2"	(14)
6	○	●	●												
9		○	●	●											
13			○	○	●	●	●								
16			○	○	●	●	●	●	●						
19					○	●	●	●	●	●					
25						○	●	●	●	●	●	●			
32							○	○	●	●	●	●	●	●	●
Bore ref.	8	11	14	16	18	19	20	22	24	28	31	32	35	36	38

○ B1 only ● B1 & B2

Multi-Beam

Aluminium Multi-Helix Flexible 6 Beam Couplings Non-Relieved

Set Screw Hubs

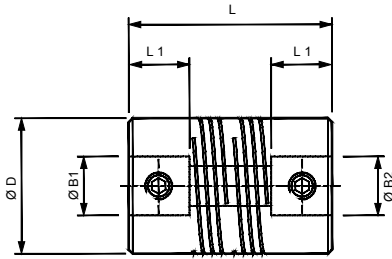

Clamp Hubs

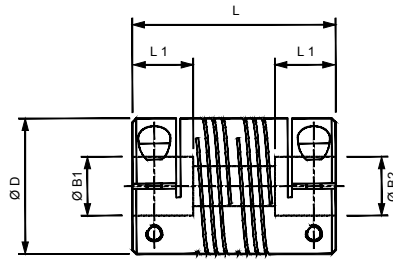

Materials & Finishes

Couplings: Aluminium L168 or better

Fasteners: Alloy steel, black oiled

Temperature Range

-40°F to +284°F

(-40°C to +120°C)

6-BEAM COUPLINGS: DIMENSIONS & ORDER CODES

Coupling Type & Size	Set Screw Style	Clamp Type	ØD in. (mm)	L in. (mm)	① L1 in. (mm)	Bore Diameters			Mass kgx10-3	Fasteners				② Angular Offset Deg.	② Parallel Offset mm	Torsional Stiffness Nm/rad	③ Peak Torque lb.in (Nm)	
						Min B1	Min B2	Max B1 & B2		Set Screw	Cap Screw	Torque lbs.-in. (Nm)	Wrench in. (mm)					
Non-Relieved	09	706.09	-	0.4 (9.5)	0.77 (19.6)	0.21 (5.3)	2.0	4.0	4.76	2.85	M2.5	-	4.87 (0.55)	0.51 (1.3)	3.0	.002 (0.12)	1.8	8.85 (1.0)
		-	707.09								-	M1.6	2.60 (0.29)	0.59 (1.5)				
	13	706.13	-	0.5 (12.7)	.09 (22.9)	0.26 (6.5)	3.0	5.0	6.35	5.5	M3	-	8.0 (0.90)	0.59 (1.5)	5.0	.007 (0.17)	14.0	17.7 (2.0)
		-	707.13								-	M2	5.84 (0.66)	0.59 (1.5)				
	16	706.16	-	0.63 (15.9)	1.00 (25.4)	0.26 (6.5)	3.0	6.0	8	9.8	M4	-	22.1 (2.5)	.098 (2.5)	5.0	.008 (0.2)	27.0	30.09 (3.4)
		-	707.16								-	M2.5	11.5 (1.3)	.079 (2.0)				
	19	706.19	-	0.75 (19.1)	1.04 (26.5)	0.26 (6.5)	4.76	6.35	10	14.0	M4	-	22.1 (2.5)	.098 (2.5)	7.0	0.01 (0.25)	46.0	46.9 (5.3)
		-	707.19								-	M2.5	11.5 (1.3)	.079 (2.0)				
	25	706.25	-	1.00 (25.4)	1.50 (38.1)	0.43 (11.0)	5.0	8.0	12.7	38.0	M5	-	40.7 (4.6)	.098 (2.5)	7.0	.015 (0.38)	108	88.5 (10.0)
		-	707.25								-	M3	21.2 (2.4)	.098 (2.5)				
	32	706.32	-	1.25 (31.8)	2.25 (57.2)	0.63 (16.0)	8.0	9.53	19.0	92.0	M6	-	67.3 (7.6)	0.12 (3.0)	7.0	0.02 (0.5)	225	132.8 (15.0)
		-	707.32						16.0		-	M4	49.6 (5.6)	0.12 (3.0)				
	38	706.38	-	1.50 (38.1)	2.63 (66.7)	0.71 (18.0)	8.0	12.0	22.0	154	M6	-	67.3 (7.6)	0.12 (3.0)	7.0	.024 (0.6)	315	194.7 (22.0)
		-	707.38						19.0		-	M5	97.4 (11.0)	0.16 (4.0)				
	44	706.44	-	1.75 (44.5)	3.00 (76.2)	0.79 (20.0)	9.0	14.0	25.0	239	M6	-	67.3 (7.6)	0.11 (3.0)	7.0	.031 (0.8)	459	265.5 (30.0)
		-	707.44						22.0		-	M5	97.4 (11.0)	0.16 (4.0)				
51	706.51	-	2.00 (50.8)	3.75 (95.3)	0.98 (25.0)	10.0	16.0	28.0	389	M8	-	159 (18)	0.16 (4.0)	7.0	0.35 (0.9)	666	354 (40.0)	
	-	707.51						26.0		-	M6	168 (19)	0.20 (5.0)					
57	706.57	-	2.25 (57.2)	5.12 (130)	1.26 (32.0)	10.0	20.0	32.0	674	M8	-	159 (18)	0.16 (4.0)	7.0	.037 (0.95)	918	486.8 (55.0)	
	-	707.57						30.0		-	M6	168 (19)	0.20 (5.0)					
64	706.64	-	2.5 (63.5)	5.91 (150)	1.5 (38.0)	12.0	25.0	38.0	1118	M8	-	159 (18)	0.16 (4.0)	7.0	0.39 (1.0)	1125	663.8 (75.0)	
	-	707.64						36.0		-	M8	407 (46)	0.24 (6.0)					

① Length of supported bore.

③ **Peak torque.** Select a size where Peak Torque exceeds the application torque x service factor. (see page 4)

② Max. compensation values are mutually exclusive.

BORE SIZES 6-BEAM COUPLINGS, NON-RELIEVED

○ B1 only

● B1 & B2

Sizes indicated in parenthesis are metric (mm).

Coupling Size	ØB1, ØB2 +0.0012/-0 (+0.03mm/-0mm)																															
	(2)	(3)	1/8"	(4)	3/16"	(5)	(6)	1/4"	(8)	3/8"	(10)	(12)	1/2"	(14)	5/8"	(16)	(18)	(19)	3/4"	(20)	(24)	(25)	1"	(28)	(30)	1 1/4"	(32)					
9	○	○	○	●	●																											
13		○	○	○	○	●	●	●																								
16		○	○	○	○	○	●	●	●																							
19				○	○	○	○	●	●	●																						
25					○	○	○	○	●	●	●	●	●																			
32						○	○	○	○	○	○	○	○	○	○	○	○	○	○	○	○	○	○	○	○	○	○	○	○			
38							○	○	○	○	○	○	○	○	○	○	○	○	○	○	○	○	○	○	○	○	○	○	○			
44								○	○	○	○	○	○	○	○	○	○	○	○	○	○	○	○	○	○	○	○	○	○			
51									○	○	○	○	○	○	○	○	○	○	○	○	○	○	○	○	○	○	○	○	○			
57										○	○	○	○	○	○	○	○	○	○	○	○	○	○	○	○	○	○	○	○			
64											○	○	○	○	○	○	○	○	○	○	○	○	○	○	○	○	○	○	○			
Bore ref.	11	14	16	18	19	20	22	24	28	31	32	35	36	38	41	42	45	46	47	48	51	52	53	54	56	57	58					

Aluminium Multi-Helix Flexible 6 Beam Couplings

Set Screw Hubs

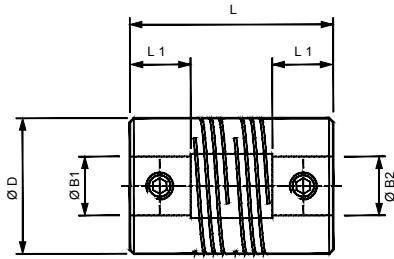

Clamp Hubs

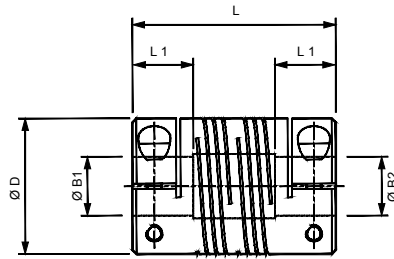

Materials & Finishes

Couplings: Aluminium L168 or better

Fasteners: Alloy steel, black oiled

Temperature Range

-40°F to +284°F

(-40°C to +120°C)

6-BEAM COUPLINGS: DIMENSIONS & ORDER CODES

Coupling Type & Size	Set Screw Style	Clamp Type	ØD in. (mm)	L in. (mm)	① L1 in. (mm)	Bore Diameters			Mass kgx10-3	Fasteners				② Angular Offset Deg.	② Parallel Offset mm	④ Torsional Stiffness Nm/rad	③ Peak Torque lb.in (Nm)
						Min B1	Min B2	Max B1 & B2		Set Screw	Cap Screw	Torque lbs.-in. (Nm)	Wrench in. (mm)				
Relieved	09	726.09 -	0.4 (9.5)	0.77 (19.6)	0.21 (5.3)	2.0	3.0	4.76	2.5	M2.5	-	4.87 (0.55)	0.51 (1.3)	3.0	.002 (0.12)	0.9	5.31 (0.6)
		-	727.09							-	M1.6	2.60 (0.29)	0.59 (1.50)				
	13	726.13 -	0.5 (12.7)	.09 (22.9)	0.26 (6.5)	3.0	4.0	6.35	5.0	M3	-	8.0 (0.90)	0.59 (1.5)	5.0	.007 (0.17)	7.0	11.5 (1.3)
		-	727.13							-	M2	5.84 (0.66)	0.59 (1.5)				
	16	726.16 -	0.63 (15.9)	1.00 (25.4)	0.26 (6.5)	3.0	4.0	8	8.6	M4	-	19.5 (2.2)	0.59 (1.5)	5.0	.008 (0.2)	13.5	17.7 (2.0)
		-	727.16							-	M2.5	11.5 (1.3)	.079 (2.0)				
	19	726.19 -	0.75 (19.1)	1.04 (26.5)	0.26 (6.5)	4.76	5.0	10	12.4	M4	-	19.5 (2.2)	.098 (2.5)	7.0	0.01 (0.25)	23.0	26.6 (3.0)
		-	727.19							-	M2.5	11.5 (1.3)	.079 (2.0)				
	25	726.25 -	1.00 (25.4)	1.50 (38.1)	0.43 (11.0)	5.0	6.0	12.7	35.0	M5	-	40.7 (4.6)	.098 (2.5)	7.0	.015 (0.38)	54	44.25 (5.0)
		-	727.25							-	M3	21.2 (2.4)	.098 (2.5)				
	32	726.32 -	1.25 (31.8)	2.25 (57.2)	0.63 (16.0)	8.0	9.53	19.0	84.0	M6	-	67.3 (7.6)	0.12 (3.0)	7.0	0.02 (0.5)	112	61.96 (7.0)
		-	727.32					16.0		-	M4	49.6 (5.6)	0.12 (3.0)				
	38	726.38 -	1.50 (38.1)	2.63 (66.7)	0.71 (18.0)	8.0	12.0	22.0	140	M6	-	67.3 (7.6)	0.12 (3.0)	7.0	.024 (0.6)	157	97.36 (11.0)
		-	727.38					19.0		-	M5	97.4 (11.0)	0.16 (4.0)				
	44	726.44 -	1.75 (44.5)	3.00 (76.2)	0.79 (20.0)	9.0	14.0	25.0	218	M6	-	67.3 (7.6)	0.11 (3.0)	7.0	.031 (0.8)	229	132.7 (15.0)
		-	727.44					22.0		-	M5	97.4 (11.0)	0.16 (4.0)				
51	726.51 -	2.00 (50.8)	3.75 (95.3)	0.98 (25.0)	10.0	16.0	28.0	348	M8	-	159 (18)	0.16 (4.0)	7.0	0.35 (0.9)	333	177.0 (20.0)	
	-	727.51					26.0		-	M6	168 (19)	0.20 (5.0)					
57	726.57 -	2.25 (57.2)	5.12 (130)	1.26 (32.0)	10.0	20.0	32.0	593	M8	-	159 (18)	0.16 (4.0)	7.0	.037 (0.95)	459	247.8 (28.0)	
	-	727.57					30.0		-	M6	168 (19)	0.20 (5.0)					
64	726.64 -	2.5 (63.5)	5.91 (150)	1.5 (38.0)	12.0	25.0	38.0	1198	M8	-	159 (18)	0.16 (4.0)	7.0	0.39 (1.0)	560	336.6 (38.0)	
	-	727.64					36.0		-	M8	407 (46)	0.24 (6.0)					

① Length of supported bore.

③ **Peak torque.** Select a size where Peak Torque exceeds the application torque x service factor. (see page 4)

② Max. compensation values are mutually exclusive. ④ Torsional Stiffness values based on maximum bores, for smaller bore combinations the values are nearer the non-relieved type.

BORE SIZES 6-BEAM COUPLINGS, RELIEVED

○ B1 only ● B1 & B2 Sizes indicated in parenthesis are metric (mm).

Coupling Size	ØB1, ØB2 +0.0012/-0 (+0.03mm/-0mm)																															
	(2)	(3)	1/8"	(4)	3/16"	(5)	(6)	1/4"	(8)	3/8"	(10)	(12)	1/2"	(14)	5/8"	(16)	(18)	(19)	3/4"	(20)	(24)	(25)	1"	(28)	(30)	1 1/4"	(32)					
9	○	●	●	●																												
13		○	○	●	●	●	●	●																								
16		○	○	●	●	●	●	●	●																							
19				○	●	●	●	●	●	●																						
25					○	●	●	●	●	●	●																					
32									○	●	●	●	●	●	●	●																
38									○	●	●	●	●	●	●	●	●	●														
44										○	○	○	○	○	○	○	○	○	○	○	○	○	○	○	○	○	○	○	○			
51											○	○	○	○	○	○	○	○	○	○	○	○	○	○	○	○	○	○	○			
57												○	○	○	○	○	○	○	○	○	○	○	○	○	○	○	○	○	○			
64													○	○	○	○	○	○	○	○	○	○	○	○	○	○	○	○	○			
Bore ref.	11	14	16	18	19	20	22	24	28	31	32	35	36	38	41	42	45	46	47	48	51	52	53	54	56	57	58					

Multi-Beam

Acetal Multi-Helix Flexible 3 Beam Couplings

Set Screw Hubs

Clamp Hubs

Materials & Finishes

Couplings: Acetal (natural)

Fasteners: Stainless Steel

Temperature Range

-20°F to +140°F

(-20°C to +60°C)

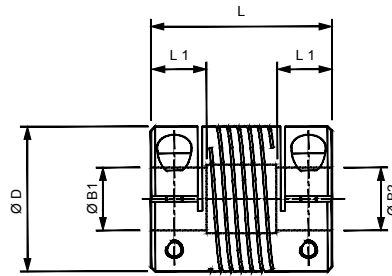
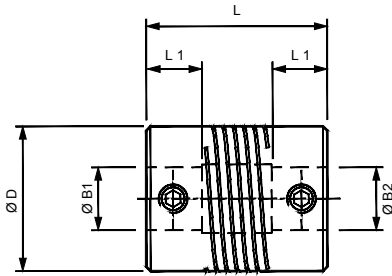

3-BEAM COUPLINGS: DIMENSIONS & ORDER CODES

Coupling Type & Size	Set Screw Style	Clamp Type	ØD in. (mm)	L in. (mm)	① L1 in. (mm)	Bore Diameters			Mass kgx10-3	Fasteners				② Angular Offset Deg.	② Parallel Offset mm	Torsional Stiffness Nm/rad	③ Peak Torque lb.in (Nm)	
						Min B1	Min B2	Max B1 & B2		Set Screw	Cap Screw	Torque lbs.-in. (Nm)	Wrench in. (mm)					
Relieved	13	728.13	-	0.50 (12.7)	.750 (19.1)	0.24 (6.0)	3.0	4.0	5.0	2.9	M3	-	2.83 (0.32)	.059 (1.5)	5.0	.005 (.127)	1.9	2.12 (0.24)
		-	729.13									-	M2	2.04 (0.23)				
	16	728.16	-	0.63 (15.9)	0.80 (20.3)	0.26 (6.5)	3.0	4.0	6.0	4.9	M4	-	9.29 (1.05)	.079 (2.0)	5.0	.005 (.127)	2.7	3.10 (0.35)
		-	729.16									-	M2.5	4.51 (0.51)				
	19	728.19	-	0.75 (19.1)	0.90 (22.9)	0.26 (6.5)	4.0	4.76	8.0	7.5	M4	-	9.29 (1.05)	.079 (2.0)	5.0	.005 (.127)	4.0	5.66 (0.64)
		-	729.19									-	M2.5	4.51 (0.51)				
25	728.25	-	1.0 (25.4)	1.25 (31.8)	0.35 (9.0)	5.0	6.0	10.0	19.0	M5	-	18.6 (2.10)	.098 (2.5)	5.0	.005 (.127)	11	12.39 (1.40)	
	-	729.25									-	M3	8.0 (0.90)					.098 (2.5)
32	728.32	-	1.25 (31.8)	1.75 (44.5)	0.47 (12.0)	6.0	8.0	14.0	44.0	M6	-	33 (3.75)	0.12 (3.0)	5.0	.005 (.127)	21	22.13 (2.50)	
	-	729.32									-	M4	18.9 (2.14)					0.12 (3.0)

① Length of supported bore.

③ **Peak torque.** Select a size where Peak Torque exceeds the application torque x service factor. (see page 4)

② Max. compensation values are mutually exclusive.

BORE SIZES 3-BEAM COUPLINGS

Sizes indicated in parenthesis are metric (mm).

Coupling Size	ØB1, ØB2 +0.0012/-0 (+0.03mm/-0mm)												
	(1)	(2)	(3)	1/8"	(4)	3/16"	(5)	(6)	1/4"	(8)	3/8"	(10)	(12)
13			○	○	●	●	●						
16			○	○	●	●	●						
19					○	●	●	●	●	●			
25							○	●	●	●	●	●	
32								○	○	●	●	●	●
Bore ref.	8	11	14	16	18	19	20	22	24	28	31	32	35

○ B1 only

● B1 & B2

Acetal Multi-Helix Flexible 6 Beam Couplings Non-Relieved

Set Screw Hubs

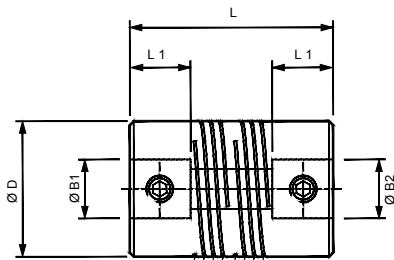

Clamp Hubs

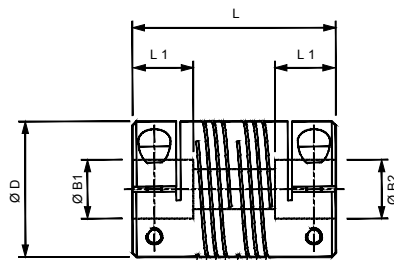

Materials & Finishes

Couplings: Acetal (natural)
Fasteners: Stainless Steel

Temperature Range

-20°F to +140°F
 (-40°C to +60°C)

6-BEAM COUPLINGS: DIMENSIONS & ORDER CODES

Coupling Type & Size	Set Screw Style	Clamp Type	ØD in. (mm)	L in. (mm)	① L1 in. (mm)	Bore Diameters			Mass kgx10-3	Fasteners				② Angular Offset Deg.	② Parallel Offset mm	④ Torsional Stiffness Nm/rad	③ Peak Torque lb.in (Nm)	
						Min B1	Min B2	Max B1 & B2		Set Screw	Cap Screw	Torque lbs.-in. (Nm)	Wrench in. (mm)					
Non-Relieved	13	710.13 -	-	0.50 (12.7)	0.9 (22.9)	0.26 (6.5)	3.0	5.0	6.0	3.2	M3	-	2.83 (0.32)	.059 (1.5)	5.0	.007 (0.17)	1.3	4.51 (0.51)
		-	711.13								-	M2	2.04 (0.23)	.059 (1.5)				
	16	710.16 -	-	0.63 (15.9)	1.00 (25.4)	0.26 (6.5)	3.0	6.0	8.0	5.4	M4	-	9.29 (1.05)	.079 (2.0)	5.0	.008 (0.2)	1.8	8.05 (0.91)
		-	711.16								-	M2.5	4.51 (0.51)	.079 (2.0)				
	19	710.19 -	-	0.75 (19.1)	1.04 (26.5)	0.26 (6.5)	4.0	6.35	9.53	8.0	M4	-	9.29 (1.05)	.079 (2.0)	7.0	0.01 (0.25)	2.7	11.5 (1.3)
		-	711.19								-	M2.5	4.51 (0.51)	.079 (2.0)				
	25	710.25 -	-	1.0 (25.4)	1.5 (38.1)	0.43 (11.0)	5.0	8.0	12.0	21.0	M5	-	18.6 (2.10)	.098 (2.5)	7.0	0.15 (0.38)	8.0	22.13 (2.5)
		-	711.25								-	M3	8.0 (0.90)	.098 (2.5)				
	32	710.32 -	-	1.25 (31.8)	2.25 (57.2)	0.63 (16.0)	6.0	10.0	16.0	51.0	M6	-	33 (3.75)	0.12 (3.0)	7.0	0.02 (0.5)	14.0	35.4 (4.0)
		-	711.32								-	M4	18.9 (2.14)	0.12 (3.0)				

- ① Length of supported bore. ③ **Peak torque.** Select a size where Peak Torque exceeds the application torque x service factor. (see page 4)
 ② Max. compensation values are mutually exclusive. ④ Torsional Stiffness values based on maximum bores, for smaller bore combinations the values are nearer the non-relieved type.

BORE SIZES 6-BEAM COUPLINGS, NON-RELIEVED

Sizes indicated in parenthesis are metric (mm).

Coupling Size	ØB1, ØB2 +0.0012/ -0 (+0.03mm/-0mm)															
	(2)	(3)	1/8"	(4)	3/16"	(5)	(6)	1/4"	(8)	3/8"	(10)	(12)	1/2"	(14)	5/8"	(16)
13		○	○	○	○	●	●									
16		○	○	○	○	○	●	●								
19					○	○	○	●	●	●						
25						○	○	○	●	●	●	●				
32									○	○	●	●	●	●	●	●
Bore ref.	11	14	16	18	19	20	22	24	28	31	32	35	36	38	41	42

○ B1 only ● B1 & B2

Multi-Beam

Acetal Multi-Helix Flexible 6 Beam Couplings

Set Screw Hubs

Clamp Hubs

Materials & Finishes

Couplings: Acetal (natural)

Fasteners: Stainless Steel

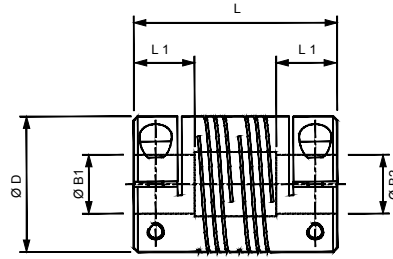
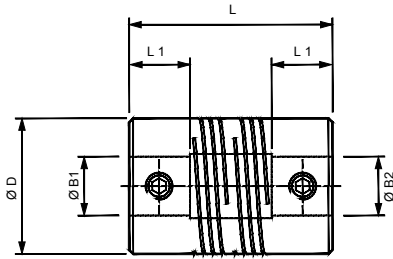

Temperature Range

-20°F to +140°F

(-20°C to +60°C)

6-BEAM COUPLINGS: DIMENSIONS & ORDER CODES

Coupling Type & Size	Set Screw Style	Clamp Type	ØD in. (mm)	L in. (mm)	L1 in. (mm)	Bore Diameters			Mass kgx10-3	Fasteners				Angular Offset Deg.	Parallel Offset mm	Torsional Stiffness Nm/rad	Peak Torque lb.in (Nm)	
						Min B1	Min B2	Max B1 & B2		Set Screw	Cap Screw	Torque lbs.-in. (Nm)	Wrench in. (mm)					
Relieved	13	730.13	-	0.50 (12.7)	0.9 (22.9)	0.26 (6.5)	3.0	4.0	5.0	3.2	M3	-	2.83 (0.32)	.059 (1.5)	5.0	.007 (0.17)	0.5	2.83 (.32)
		-	731.13								-	M2	2.04 (0.23)	.059 (1.5)				
	16	730.16	-	0.63 (15.9)	1.00 (25.4)	0.26 (6.5)	3.0	4.0	6.35	5.4	M4	-	9.29 (1.05)	.079 (2.0)	5.0	.008 (0.2)	0.7	5.40 (.61)
		-	731.16								-	M2.5	4.51 (0.51)	.079 (2.0)				
	19	730.19	-	0.75 (19.1)	1.04 (26.5)	0.26 (6.5)	4.0	5.0	8.0	7.8	M4	-	9.29 (1.05)	.079 (2.0)	7.0	0.01 (0.25)	1.0	7.70 (.87)
		-	731.19								-	M2.5	4.51 (0.51)	.079 (2.0)				
	25	730.25	-	1.0 (25.4)	1.5 (38.1)	0.43 (11.0)	5.0	6.0	10.0	21.0	M5	-	18.6 (2.10)	.098 (2.5)	7.0	.015 (0.38)	3.2	14.80 (1.67)
		-	731.25								-	M3	8.0 (0.90)	.098 (2.5)				
	32	730.32	-	1.25 (31.8)	1.25 (31.8)	2.25 (57.2)	8.0	9.53	12.7	52.0	M6	-	33 (3.75)	0.12 (3.0)	7.0	0.02 (0.5)	5.6	21.1 (2.4)
		-	731.32								-	M4	18.9 (2.14)	0.12 (3.0)				

① Length of supported bore.

③ **Peak torque.** Select a size where Peak Torque exceeds the application torque x service factor. (see page 4)

② Max. compensation values are mutually exclusive.

BORE SIZES 6-BEAM COUPLINGS, RELIEVED

Sizes indicated in parenthesis are metric (mm).

Coupling Size	ØB1, ØB2 +0.0012/ -0 (+0.03mm/-0mm)												
	(2)	(3)	1/8"	(4)	3/16"	(5)	(6)	1/4"	(8)	3/8"	(10)	(12)	1/2"
13		○	○	●	●	●							
16		○	○	●	●	●	●	●					
19					○	●	●	●	●				
25						○	●	●	●	●	●		
32									○	●	●	●	●
Bore ref.	11	14	16	18	19	20	22	24	28	31	32	35	36

○ B1 only ● B1 & B2

Step Beam Couplings - Nylon



Materials & Finishes

Couplings: Nylon type engineering polymer

Fasteners: Stainless Steel

Temperature Range

-20°F to +302°F
(-20°C to +150°C)

Set Screw Hubs

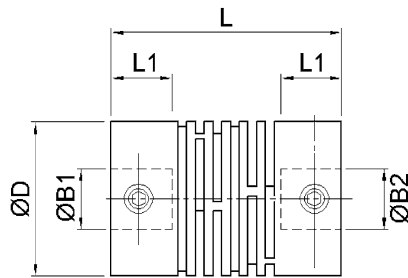

Clamp Hubs

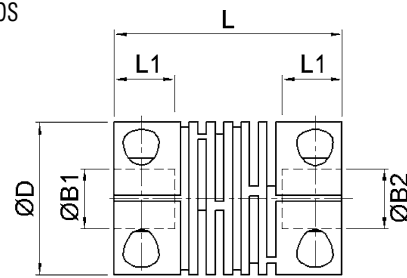

DIMENSIONS & ORDER CODES

Size	Set Screw Style	Clamp Style	Dimensions						Fasteners			
	Order Code		O.D. in. (mm)	O/A Length L in. (mm)	Max Shaft Depth L1 in. (mm)	Min Bore	Max Bore	Mass kg x 10-3	Set Screw	Cap Screw	Torque lb.-in. (Ncm)	A/F in. (mm)
25	636.25	-	0.98 (25)	1.42 (36)	0.39 (10.0)	6	12.7	17.4	M4	-	0.09 (1.05)	.079 (2.0)
	-	637.25							-	M3	0.08 (0.90)	.098 (2.5)

PERFORMANCE

Size	Peak Torque in. (Nm)	Torsional Stiffness (Nm/rad)	Max misalignment / displacement		
			Angular deg	Radial in. (mm)	Axial in. (mm)
25	0.98 (2.5)	18.0	5	.012 (0.3)	.012 (0.3)

AVAILABLE BORES

Sizes indicated in parenthesis are metric (mm).

Size	Available Bore Sizes							
	(6)	1/4"	5/16"	(8)	3/8"	(10)	(12)	1/2"
25	●	●	●	●	●	●	●	●
Bore Ref	22	24	27	28	31	32	35	36

S-Beam

Single Helix Beam Couplings - Stainless Steel

Set Screw Hubs

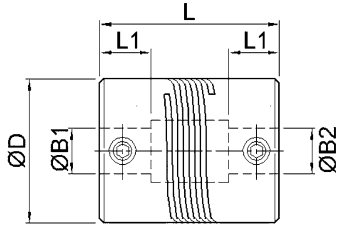

Clamp Hubs

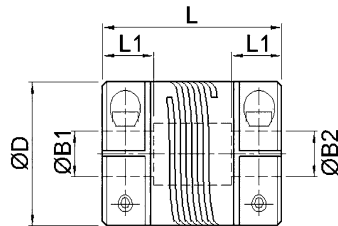

DIMENSIONS & ORDER CODES

Size	Set Screw Style	Clamp Style	Dimensions							Fasteners			
	Order Code		O.D. in. (mm)	O/A Length L in. (mm)	Bore Depth L1 in. (mm)	Min B1	Min B2	Max B1 & B2	Mass kg x 10-3	Set Screw	Cap Screw	Torque lb.-in. (Nm)	A/F in. (mm)
16	820.16	-	0.63 (15.9)	0.79 (20)	0.25 (6.0)	3	4	6.35	25.6	M4	-	9.29 (1.05)	0.08 (2.0)
	-	821.16		0.87 (22)	0.26 (6.5)				26.0	-	M2.5	6.02 (0.68)	0.08 (2.0)
19	820.19	-	0.75 (19.1)	0.79 (20)	0.25 (6.0)	4	4.76	8	35.8	M4	-	9.29 (1.05)	0.08 (2.0)
	-	821.19		1.1 (28)	0.31 (8.0)				47.7	-	M2.5	6.02 (0.68)	0.08 (2.0)
25	820.25	-	1.0 (25.4)	0.94 (24)	0.3 (7.5)	5	6	10	78	M5	-	18.59 (2.10)	0.1 (2.5)
	-	821.25		1.18 (30)	0.39 (10.0)				91	-	M3	10.62 (1.20)	0.1 (2.5)
32	820.32	-	1.25 (31.8)	1.18 (30)	0.39 (10.0)	6	8	16	152	M6	-	33.19 (3.75)	0.12 (3.0)
	-	821.32		1.5 (38)	0.47 (12.0)				186	-	M4	25.22 (2.85)	0.12 (3.0)
38	820.38	-	1.5 (38.1)	1.97 (50)	0.63 (16.0)	8	12	19	365	M6	-	33.19 (3.75)	0.12 (3.0)
	-	821.38		1.97 (50)	0.63 (16.0)				350	-	M5	51.78 (5.85)	0.16 (4.0)
50	820.50	-	2.0 (50.8)	2.13 (54)	0.71 (18.0)	10	16	26	680	M8	-	79.66 (9.00)	0.16 (4.0)
	-	821.50		2.13 (54)	0.71 (18.0)				660	-	M6	86.29 (9.75)	0.2 (5.0)

PERFORMANCE

Size	Peak Torque lb.-in. (Nm)	Max misalignment compensation			Nominal stiffness at std. bore size	
		Angular deg	Radial in. (mm)	Axial in. (mm)	Bore	Torsional Nm/rad
16	10.62 (1.2)	5	0.01 (0.25)	0.01 (0.25)	5	16
19	20.36 (2.3)	5	0.01 (0.25)	0.01 (0.25)	6	33
25	38.06 (4.3)	5	0.01 (0.25)	0.01 (0.25)	10	45
32	69.04 (7.8)	5	0.01 (0.25)	0.01 (0.25)	12	84
38	177 (20)	5	0.01 (0.25)	0.01 (0.25)	16	195
50	265 (30)	5	0.01 (0.25)	0.01 (0.25)	20	320

Materials & Finishes

Couplings: Stainless Steel 303 S31

Fasteners: Stainless Steel

Temperature Range

-40°F to +284°F
(-40°C to +140°C)

AVAILABLE BORES

Sizes indicated in parenthesis are metric (mm).

Size	ØB1, ØB2 +0.0012/-0 (+0.03mm/-0mm)																						
	(3)	1/8"	(4)	3/16"	(5)	(6)	1/4"	5/16"	(8)	(9)	3/8"	(10)	(12)	1/2"	(14)	(15)	5/8"	(16)	3/4"	(20)	(25)	1"	
16	○	○	●	●	●	●	●																
19			○	●	●	●	●		●														
25					○	●	●	●	●	●	●	●											
32						○	○	●	●	●	●	●	●	●	●	●	●	●					
38											○	○	●	●	●	●	●	●	●				
50														○	○	○	○	●	●	●	●	●	●
Bore Ref	14	16	18	19	20	22	24	27	28	30	31	32	35	36	38	40	41	42	47	48	52	53	

○ B1 only ● B1 & B2

Single Helix Beam Couplings - Aluminium

Set Screw Hubs

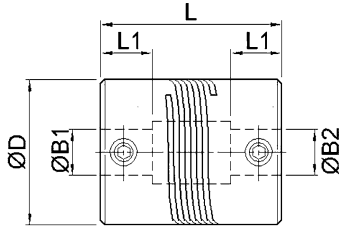

Clamp Hubs

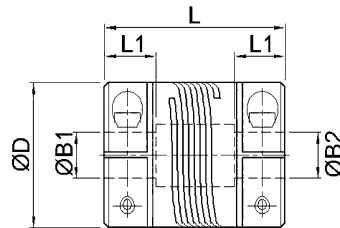

DIMENSIONS & ORDER CODES

Size	Set Screw Style	Clamp Style	Dimensions							Fasteners			
			Order Code	O.D. in. (mm)	O/A Length L in. (mm)	Bore Depth L1 in. (mm)	Min B1	Min B2	Max B1 & B2	Mass kg x 10-3	Set Screw	Cap Screw	Torque lb.-in. (Nm)
16	826.16	-	0.63 (15.9)	0.79 (20)	0.25 (6.0)	3	4	6.35	8.8	M4	-	20.09 (2.27)	0.08 (2.0)
	-	827.16		0.87 (22)	0.26 (6.5)				9.8	-	M2.5	11.68 (1.32)	0.08 (2.0)
19	826.19	-	0.75 (19.1)	0.79 (20)	0.25 (6.0)	4	4.76	8	13.1	M4	-	20.09 (2.27)	0.08 (2.0)
	-	827.19		1.1 (28)	0.31 (8.0)				17.3	-	M2.5	11.68 (1.32)	0.08 (2.0)
25	826.25	-	1.0 (25.4)	0.94 (24)	0.3 (7.5)	5	6	10	28	M5	-	40.89 (4.62)	0.1 (2.5)
	-	827.25		1.18 (30)	0.39 (10.0)				33	-	M3	21.5 (2.43)	0.1 (2.5)
32	826.32	-	1.25 (31.8)	1.18 (30)	0.39 (10.0)	6	8	16	55	M6	-	67.35 (6.1)	0.12 (3.0)
	-	827.32		1.5 (38)	0.47 (12.0)				67	-	M4	50.09 (5.66)	0.12 (3.0)
38	826.38	-	1.25 (38.1)	1.97 (50)	0.63 (16.0)	8	12	19	127	M6	-	67.35 (7.61)	0.12 (3.0)
	-	827.38		1.97 (50)	0.63 (16.0)				130	-	M5	100.9 (11.4)	0.16 (4.0)
50	826.50	-	2.0 (50.8)	2.13 (54)	0.71 (18.0)	10	16	26	241	M8	-	164.6 (18.36)	0.16 (4.0)
	-	827.50		2.13 (54)	0.71 (18.0)				237	-	M6	171.1 (19.34)	0.2 (5.0)

PERFORMANCE

Size	Peak Torque in. (Nm)	Max misalignment compensation			Nominal stiffness at std. bore size	
		Angular deg	Radial in. (mm)	Axial in. (mm)	Bore	Torsional Nm/rad
16	0.02 (0.6)	5	0.01 (0.25)	0.01 (0.25)	5	6
19	0.04 (1.1)	5	0.01 (0.25)	0.01 (0.25)	6	12
25	0.09 (2.2)	5	0.01 (0.25)	0.001 (0.25)	10	17
32	0.16 (4.1)	5	0.01 (0.25)	0.01 (0.25)	12	32
38	0.39 (10)	5	0.01 (0.25)	0.01 (0.25)	16	70
50	0.59 (15)	5	0.01 (0.25)	0.01 (0.25)	20	119

Materials & Finishes

Couplings: Aluminium L 168 or better

Fasteners: Alloy steel, black oiled

Temperature Range

-40°F to +248°F
(-40°C to +120°C)

AVAILABLE BORES

Sizes indicated in parenthesis are metric (mm).

Size	ØB1, ØB2 +0.0012/ -0 (+0.03mm/-0mm)																						
	(3)	1/8"	(4)	3/16"	(5)	(6)	1/4"	5/16"	(8)	(9)	3/8"	(10)	(12)	1/2"	(14)	(15)	5/8"	(16)	3/4"	(20)	(25)	1"	
16	○	○	●	●	●	●	●																
19			○	●	●	●	●		●														
25					○	●	●	●	●	●	●	●											
32						○	○	●	●	●	●	●	●	●	●	●	●	●					
38											○	○	●	●	●	●	●	●	●				
50														○	○	○	○	●	●	●	●	●	●
Bore Ref	14	16	18	19	20	22	24	27	28	30	31	32	35	36	38	40	41	42	47	48	52	53	

○ B1 only ● B1 & B2



Drive Couplings

- Flexible Double Loop
- Flexible Jaw (Spider)

General purpose couplings for light power drives.



Flex-G

Flexible Jaw Coupling

Huco Flexible Jaw Couplings utilize the flexibility and resilience of a polyurethane element between aluminium hubs. This combination allows high torque to be transmitted with little or no backlash, even where there is significant angular and/or parallel misalignment.

- Zero / Low backlash
- Rated up to 17Nm Torque
- Choice of 3 polyurethane elements



Set Screw Hubs

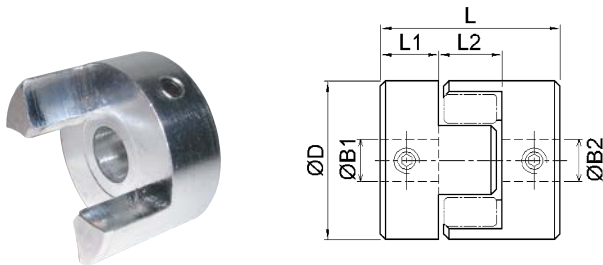

Thro' Clamp Hubs

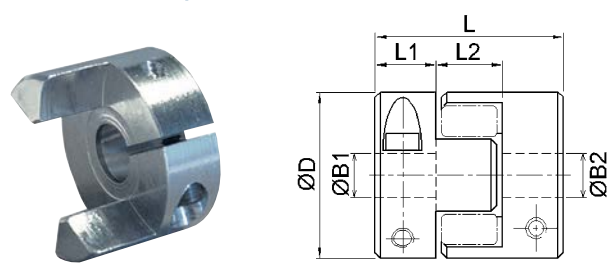

Pilot Hubs

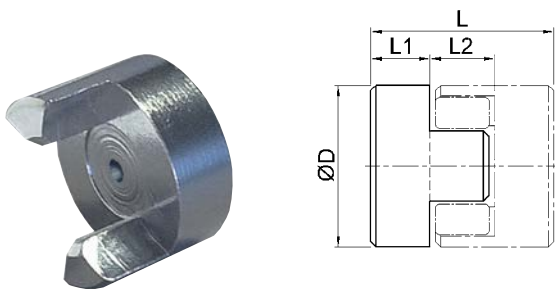

User-adaptable for special needs e.g. fitting within tubes. Blank hubs are supplied centered with no provision for fastening. External dimensions identical with blind hubs. Except size 40 which has 6.35mm pilot hole.

Elements

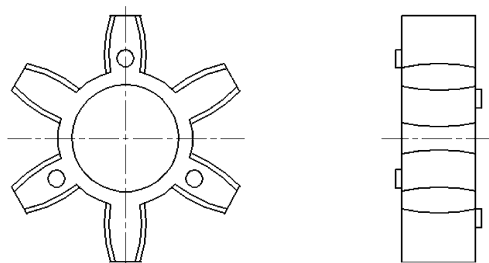

Polyurethane elements are available with three hardness levels; hard, standard and soft which exhibit different operating characteristics. Other features of polyurethane are:

- Resistance to oils, grease and many solvents
- Good atmospheric and chemical resistance
- Excellent shock and vibration damping

Flexible Jaw Coupling

DIMENSIONS & ORDER CODES

Coupling Size	Set Screw Style	Clamping Style	Pilot Hub	ØD in. (mm)	L in. (mm)	L1 in. (mm) ①	L2 in. (mm)	ØB1 max in. (mm) ⑥	Fasteners			Moment of inertia kgm ² x 10 ⁻⁸ ③	Mass kg x 10 ⁻³ ③	Soft (Blue)	Med (White)	Hard (Red)
									Screw	Torque lb.-in. (Nm)	Wrench in. (mm)					
14	802.14	-	-	0.55 (14.0)	0.87 (22.0)	0.28 (7.0)	0.31 (8.0)	0.25 (6.35)	M3	0.94	1.5	18.4	7.0	804.14	805.14	806.14
	-	803.14	-						M2.5	1.32	2.5					
	-	-	800.14						-	-	-					
20	802.20	-	-	0.79 (20.0)	1.18 (30.0)	0.39 (10.0)	0.39 (10.0)	0.35 (9.0)	M3	0.94	1.5	106.0	17.0	804.20	805.20	806.20
	-	803.20	-						M3	2.43	2.5					
	-	-	800.20						-	-	-					
30	802.30	-	-	1.18 (30.0)	1.38 (35.0)	0.43 (11.0)	0.51 (13.0)	0.55 (14.0)	M4	2.27	2.0	606.0	51.0	804.30	805.30	806.30
	-	803.30	-						M3	2.43	2.5					
	-	-	800.30						-	-	-					
40	802.40	-	-	1.57 (40.0)	2.60 (66.0)	0.98 (25.0)	0.63 (16.0)	0.63 (16.0)	M5	4.62	2.5	4230.0	108.0	804.40	805.40	806.40
	-	803.40	-						M4	5.66	3.0					
	-	-	800.40						-	-	-					

PERFORMANCE (AT 20°C)

Coupling Size	Spider Rigidity Duro ⑦	Misalignment		Speed R.P.M max	Torsional ⑤		Backlash Free Torque lb.-in. (Nm)	Torque Nominal lb.-in. (Nm) ④	Torque Max lb.-in. (Nm)
		Angular deg	Radial in. (mm)		Rate deg/Nm	Stiffness Nm/rad			
14	80 Blue	2	.003 (0.10)	40000	6.7	8.5	1.95 (0.22)	5.93 (0.67)	11.9 (1.34)
	92 White				3.9	14.7		9.91 (1.12)	19.8 (2.24)
	98 Red				2.29	25.0		16.8 (1.90)	33.6 (3.80)
20	80 Blue	2	.006 (0.15)	28000	3.37	17	3.98 (0.45)	15.9 (1.80)	31.9 (3.60)
	92 White				2.05	28		25.9 (2.93)	53.1 (6.00)
	98 Red				1.22	47		42.9 (4.85)	85.9 (9.70)
30	80 Blue	2	.008 (0.20)	19000	1.24	71	8.85 (1.00)	35.0 (3.95)	69.9 (7.90)
	92 White				0.40	143		64.9 (7.33)	129.2 (14.60)
	98 Red				0.25	228		109.8 (12.40)	219.5 (24.80)
40	80 Blue	2	0.38	14000	0.34	170	21.2 (2.40)	42.9 (4.85)	85.9 (9.70)
	92 White				0.17	344		86.7 (9.80)	173.5 (19.60)
	98 Red				0.10	573		147.8 (16.70)	295.6 (33.40)

- ① Maximum permissible hub penetration
- ② Maximum recommended tightening torque
- ③ Values apply to complete couplings with max. bores
- ④ Nominal Torque. Select a size where Nominal Torque exceeds application torque x service factor (**see page 4**)
- ⑤ Values apply at 50% nominal torque, measured shaft to shaft with largest standard bores
- ⑥ Hubs can be provided with keyways or 'D' bores
- ⑦ Spider Durometer is shore 'A' hardness

STANDARD BORES

Sizes indicated in parenthesis are metric (mm).

ØB1, ØB2 +0.0012/ -0 (+0.03mm/-0mm)																
Coupling Size	(3)	1/8"	(4)	3/16"	(5)	(6)	1/4"	(8)	3/8"	(10)	(12)	1/2"	(14)	(15)	5/8"	(16)
14	●	●	●	●	●	●	●									
20			●	●	●	●	●									
30						●	●	●	●	●	●	●	●			
40								●	●	●	●	●	●	●	●	●
Bore ref.	14	16	18	19	20	22	24	28	31	32	35	36	38	40	41	42

Materials & Finishes

Hub sizes 14 - 30: Al. Alloy 2024
Hub size 40: Cast Aluminium LM9
Membranes: Polyurethane
Fastener: Alloy steel, black oiled

Temperature Range

-40°F to +176°F (-40°C to +80°C)
 For short durations up to 202°F (100°C)

Note: Larger sizes available. Please ask for details.

Double Loop Flexible Coupling

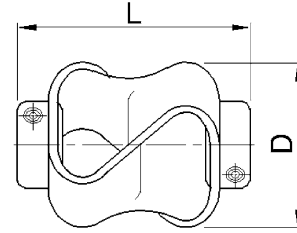
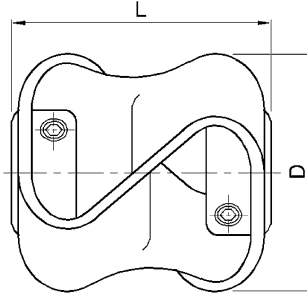

DIMENSIONS & ORDER CODES

Size	Steel zinc plated hubs	Stainless steel hubs	Dimensions					Fasteners		
	Order Code		Max Diameter in. (mm)	Length L in. (+/- 1.0 mm)	Bore length in. (mm)	Max Bores	Mass kg x 10-3	Size	Torque lb.-in. (Nm)	A/F in. (mm)
10	047.10	-	1.06 (27)	1.06 (27)	0.31 (7.9)	9.53	25	M3	8.32 (0.94)	0.17 (1.5)
	-	049.10							.036 (0.32)	
20	047.20	-	1.89 (48)	1.89 (48)	0.50 (12.7)	12.7	92	M4	0.26 (2.27)	0.23 (2.0)
	-	049.20							0.23 (2.0)	
30	047.30	-	2.13 (54)	2.17 (55)	0.63 (16.0)	16.0	124	M5	0.52 (4.62)	0.28 (2.5)
	-	049.30							0.24 (2.1)	
40	047.40	-	2.20 (56)	2.20 (56)	0.63 (16.0)	16.0	136	M6	0.86 (7.61)	0.34 (3.0)
	-	049.40							0.43 (3.75)	

PERFORMANCE

Size	Max Torque 1 lb.-in. (Nm)	Max Torque 2 lb.-in. (Nm)	max misalignment/displacement		
			Angular deg	Radial in. (mm)	Axial in. (+/- mm)
10	4.43 (0.5)	7.08 (0.8)	10	0.10 (2.6)	0.18 (4.5)
20	15.9 (1.8)	26.6 (3)	15	0.13 (3.2)	0.30 (7.5)
30	44.3 (5)	70.8 (8)	15	0.13 (3.2)	0.33 (8.5)
40	88.5 (10)	159.3 (18)	15	0.13 (3.2)	0.43 (11)

Torque 1 = torque at maximum displacement

Torque 2 = torque at 1 deg. angular, 2mm axial and 0.5mm radial displacement

Materials & Finishes

- Hubs:** Steel 230M07 pb Zn plated + clear passivate or
Stainless Steel 303 S31 natural finish
- Flexing Element:** Hytrel
- Fastener:** Steel Hub: Alloy steel, black oiled
Stainless Steel Hub: stainless steel

Temperature Range

-40°F to +212°F (-40°C to +100°C)

Maximum Rotational Speed

3000 rev/min

STANDARD BORES*

Sizes indicated in parenthesis are metric (mm).

Size	ØB1, ØB2 +0.002/ -0 (+0.05mm/-0mm)																
	(3)	1/8"	(4)	3/16"	(5)	(6)	1/4"	5/16"	(8)	3/8"	(10)	(12)	1/2"	(14)	(15)	5/8"	(16)
10	●	●	●	●	●	●	●	●	●	●							
20						●	●	●	●	●	●	●	●				
30										●	●	●	●	●	●	●	●
40										●	●	●	●	●	●	●	●
Bore Ref	14	16	18	19	20	22	24	27	28	31	32	35	36	38	40	41	42

* Couplings with dissimilar bores are non-standard



Plastic Universal Joints and Teleshaf

- Backlash-free up to 10° turns
- Low mass
- Low inertia
- Corrosion resistant
- Electrically isolating
- No maintenance

Huco-Pol is a range of light duty, backlash-free universal joints and teleshafts manufactured of acetal and non-ferrous metals.

They are suitable for intermittent applications where low mass, corrosion resistance and electrical isolation are desirable.

Huco-Pol joints and teleshafts have only a fraction of the torque capability of steel joints and are not intended to substitute for these in the normal way.

Huco-Pols are used in business machines, food processing plants, laboratory equipment and electro-medical apparatus among others.

Alternative polymers are available for high temperature operation.



Plastic Universal Joints

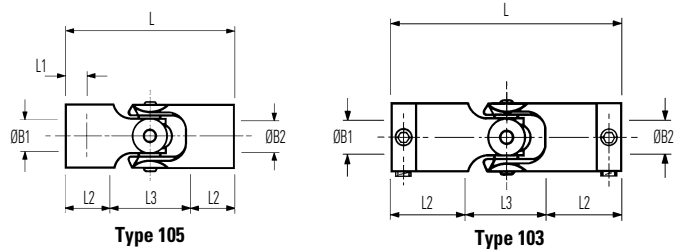

SINGLE JOINTS - DIMENSIONS & ORDER CODES

Size	Order Code	Dimensions								Fasteners		
		OD in. (mm)	L in. (mm)	L1 in. (mm)	L2 in. (mm)	L3 in. (mm)	B1, B2 Max in. (mm)	Moment of inertia kgm ² x 10 ⁻⁸	Mass kg x 10 ⁻³	Size	Torque lb.-in. (Nm)	A/F in. (mm)
06	103.06	0.28 (7.1)	1.07 (27.2)	-	0.37 (9.3)	0.34 (8.6)	0.13 (3.18)	1.1	3.1	M3	8.32 (0.94)	0.06 (1.5)
09	103.09	0.44 (11.1)	1.48 (37.6)	-	0.52 (13.1)	0.45 (11.4)	0.20 (5.0)	13.5	9.3	M3	8.32 (0.94)	0.06 (1.5)
13	103.13	0.56 (14.3)	1.82 (46.2)	-	0.62 (15.7)	0.58 (14.8)	0.25 (6.35)	44.6	17.7	M3	8.32 (0.94)	0.06 (1.5)
16	103.16	0.69 (17.5)	2.66 (67.6)	-	0.88 (22.3)	0.91 (23.0)	0.39 (10.0)	136	35	M4	20.1 (2.27)	0.08 (2.0)
20	105.20	0.90 (23.0)	2.44 (62.0)	0.31 (8.0)	0.67 (17.0)	1.10 (28.0)	0.50 (12.7)	147	25.7	-	-	-
25	105.25	1.12 (28.5)	2.91 (74.0)	0.39 (10.0)	0.79 (20.0)	1.34 (34.0)	0.55 (14)	463	56	-	-	-
32	105.32	1.44 (36.5)	3.39 (86.0)	0.39 (10.0)	0.83 (21.0)	1.73 (44.0)	0.79 (20)	1339	103	-	-	-

SINGLE JOINTS - PERFORMANCE at 68°F (20°C)

Size	Peak Torque lb.-in. (Nm)	Static Break Torque lb.-in. (Nm)	Torsional Rate deg/Nm	Torsional Stiffness Nm/Rad	Max angular compensation @ 1000 rev/min	Max axial loading N
06	0.97 (0.11)	3.98 (0.45)	19.7	2.9	45	18
09	3.19 (0.36)	16.8 (1.9)	6.8	8.4	45	38
13	7.52 (0.85)	39.8 (4.5)	3.2	18	45	67
16	14.2 (1.6)	60.2 (6.8)	1.7	34	45	98
20	24.8 (2.8)	151 (17)	0.94	61	40	138
25	49.6 (5.6)	301 (34)	0.51	112	40	222
32	94.7 (10.7)	637 (72)	0.25	229	40	334

FOR STANDARD BORES SEE FACING PAGE

Materials & Finishes

Bodies:	Acetal
Cross-pieces:	Brass BS CZ121/122 (103, 111)
Bore Inserts:	Brass BS CZ121/122 (103, 111) Al. Alloy 2014A T6 (105)
Fasteners:	Alloy steel, black oiled

Operating Temperature Range

-20°F to +140°F (- 20°C to +60°C)

Maximum Rotational Speed

1000 rev/min

Plastic Universal Joints

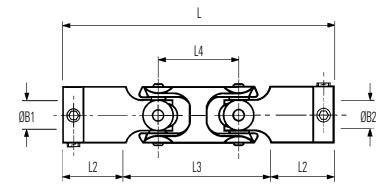

Type 111

DOUBLE JOINTS - DIMENSIONS & ORDER CODES

Size	Order Code	Dimensions									Fasteners		
		OD in. (mm)	L in. (mm)	L1 in. (mm)	L2 in. (mm)	L3 in. (mm)	L4 in. (mm)	B1, B2 Max	Moment of inertia kgm ² x 10 ⁻⁸	Mass kg x 10 ⁻³	Size	Torque lb.-in. (Nm)	A/F in. (mm)
06	111.06	0.28 (7.1)	1.39 (35.3)	-	0.37 (9.3)	0.66 (16.7)	8.1	3.18	1.3	3.5	M3	8.32 (0.94)	0.06 (1.5)
09	111.09	0.44 (11.1)	2.00 (50.8)	-	0.52 (13.1)	0.97 (24.6)	13.2	5.0	15.3	11.1	M3	8.32 (0.94)	0.06 (1.5)
13	111.13	0.56 (14.3)	2.44 (62.1)	-	0.62 (15.7)	1.21 (30.7)	15.9	6.35	50.4	21.6	M3	8.32 (0.94)	0.06 (1.5)
16	111.16	0.69 (17.5)	3.53 (89.8)	-	0.88 (22.3)	1.78 (45.2)	22.2	10.0	178.0	42.4	M4	20.1 (2.27)	0.08 (2.0)

DOUBLE JOINTS - PERFORMANCE at 68°F (20°C)

Size	Peak Torque lb.-in. (Nm)	Static Break Torque lb.-in. (Nm)	Torsional Rate deg/Nm	Torsional Stiffness Nm/Rad	Max angular compensation @ 1000 rev/min	Max radial compensation in. (mm)
06	0.71 (0.08)	3.00 (0.34)	81.9	0.7	90	49.6 (5.6)
09	1.42 (0.16)	16.82 (1.9)	13.3	4.3	90	80.5 (9.1)
13	5.22 (0.59)	30.1 (3.4)	8.1	7.1	90	96.5 (10.9)
16	11.5 (1.3)	60.2 (6.8)	4.5	12.6	90	137 (15.5)

STANDARD BORES

Size	Bore tolerances • 103, 111 = +0.0012/ -0 (+0.03mm/-0mm)																			
	(3)	1/8"	(4)	3/16"	(5)	(6)	1/4"	(8)	3/8"	(10)	(12)	1/2"	(14)	5/8"	(16)	(18)	(19)	3/4"	(20)	
06	●	●																		
09	●	●	●	●	●															
13			●	●	●	●	●													
16						●	●	●												
20								●	●	●	●	●								
25										●	●	●								
32													●	●	●	●	●	●	●	●
Bore Ref	14	16	18	19	20	22	24	28	31	32	35	36	38	41	42	45	46	47	48	

Plastic Universal Joints

Constant velocity

The velocity ratio of single universal joints is not constant when the working angle is greater than zero. Their geometry gives rise to sinusoidal fluctuations at the output that increase with the working angle and which vary between:

$$\omega \cos \beta \text{ and } \omega \sec \beta$$

where ω = angular velocity
and β = operating angle

For example, when the operating angle is 5° , the maximum error is $\pm 0.4\%$; at 7° it is $\pm 0.8\%$, and at 10° it is $\pm 1.5\%$. A motor shaft turning at a constant 1000 rpm, driving through a single universal joint set at an operating angle of 5° , produces an output that fluctuates between 996 rpm and 1004 rpm twice each revolution.

The fluctuations are cancelled out when using a double joint or two single joints connected back to back.

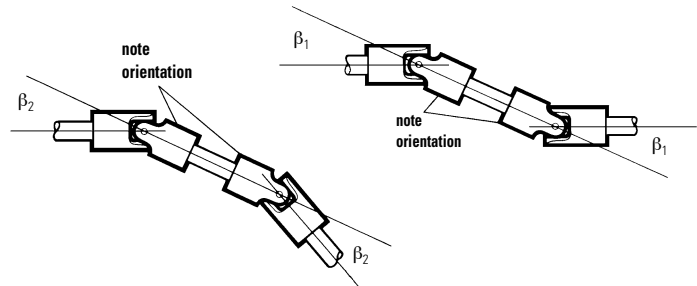

To maintain constant velocity ratio, ensure that:

- The orientation of two single joints is correct; the inboard forks should align as in double joints.
- The working angle of both joints, or both halves of a double joint, is the same.

ADJUSTED TORQUE

Peak torque values apply when the working angle is zero. Adjusted torque takes account of dynamic loading at the bearings. To find adjusted torque, determine application speed, torque and operating angle,

Then:

- multiply speed x working angle
- subtract the result from 10000
- divide the answer into 10000
- apply the result to the application torque.
 - eg. speed = 400 rpm
 - application torque = 0.1Nm
 - working angle = 20°

Accordingly:

- $400 \text{ rpm} \times 20^\circ = 8000$
- $10000 - 8000 = 2000$
- $10000 / 2000 = 5$
- $5 \times 0.1 \text{ Nm} = 0.5 \text{ Nm}$

Select a joint where Peak Torque exceeds 0.5Nm, i.e., size 13 or larger.

Note: To remain within the capacity of the joint, the result of speed x working angle must be less than 10000.

Plastic Universal Joints Brass Cross Pieces and Tubes

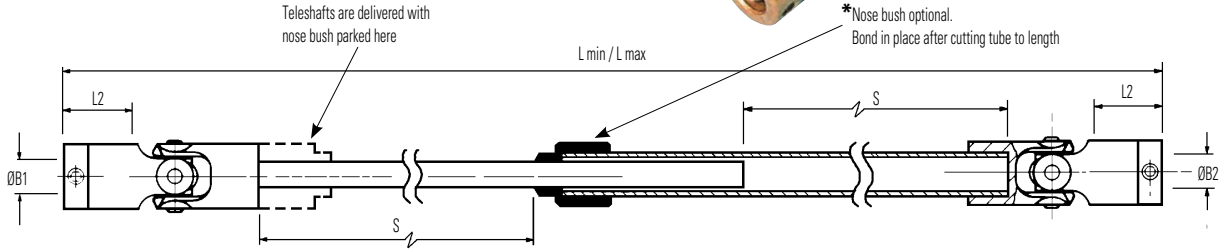
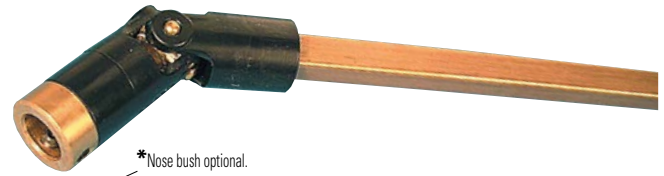

Refs. 128

Joints sleeved with headed brass inserts fitted 2 screws per end

End A
(inner tube)

End B
(outer tube)

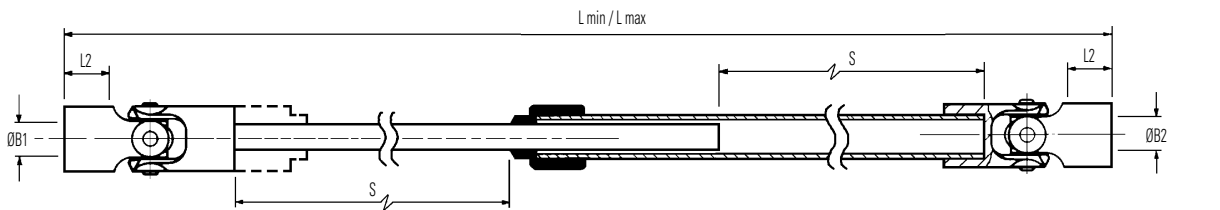

Refs. 130

Joints sleeved with metal inserts. Attach to shafts by cross-pinning or bonding

Typical

DIMENSIONS & ORDER CODES

Teleshafte size	Teleshafte options	ØD in. (mm)	L in. (mm ±1.0)	L in. (mm)	Stroke in. (mm)	L2 in. (mm)	ØB1, ØB2 max	Mass kg x 10-3	Corresponding joints. For dimensions see
	Standard tubes self-colour brass								
	teleshafte REF								
09	128.09.240	.43 (11.1)	9.45 (240)	15.3 (389)	5.87 (149)	.52 (13.1)	5	36	103.09
13	128.13.300	.56 (14.3)	11.8 (300)	19.0 (484)	7.24 (184)	.62 (15.7)	6.35	58	103.13
16	128.16.450	.69 (17.5)	17.7 (450)	28.7 (730)	11.02 (280)	.88 (22.3)	10	168	103.16
20	130.20.464	.91 (23.0)	18.3 (464)	29.3 (745)	11.06 (281)	.67 (17.0)	12.70	241	105.20
25	130.25.500	1.12 (28.5)	19.7 (500)	30.9 (784)	11.18 (284)	.79 (20.0)	14	457	105.25
32	130.32.564	1.44 (36.5)	22.2 (564)	34.2 (868)	11.97 (304)	.83 (21.0)	20	827	105.32

- ② Max shaft penetration
- ③ Values apply with max bores.

- A range of standard telescopes is available which can be shortened to achieve an infinite number of length/stroke requirements. The lengths L min shown in the table above are the longest of the standard range in each size. Specific lengths are produced by cutting an equal amount from both ends of the nearest standard size. See next page for recommended procedure.
- Custom Teleshafte assemblies can be factory made subject to minimum order quantities.
- *The nose bush eliminates any torsional free play that may be apparent in the tubes due to working clearances.
- Full details of the standard range and product order codes are available on request. Please ask for a Huco Teleshafte data sheet.

STANDARD BORES

Sizes indicated in parenthesis are metric (mm).

Teleshafte size	ØB1, ØB2 +0.0012/ -0 (+0.03mm/-0mm)															
	1/8"	(4)	3/16"	(5)	(6)	1/4"	(8)	3/8"	(10)	(12)	1/2"	5/8"	(16)	3/4"	(20)	
09	•	•	•	•												
13		•	•	•	•	•										
16					•	•	•	•	•							
20								•	•							
25										•	•					
32												•	•	•	•	
Bore ref.	16	18	19	20	22	24	28	31	32	35	36	41	42	47	48	
Corresponding bore adaptor				251		253	255		257		259		260		261	

Diameters for which a bore adaptor is shown can be adapted to smaller shaft sizes. See page 58 for details.

Huco Teleshafes

Plastic Universal Joints Brass Cross Pieces and Tubes

Extensible drive shafts (teleshafes), are useful when the distance between actuator and load varies during operation, or needs to accommodate component variances, or when a quick disconnect facility is needed in the drive line.

Huco teleshafes are in keeping with the light duty capabilities of plastics universal joints and employ precision drawn square brass tubes as the telescoping medium. These can easily be cut by the user to provide an extensible drive shaft with customised dimensions.

There are 2 ways to arrive at a customized teleshaf: empirically (shown below), or with tables that provide all necessary data on stroke and tube lengths for teleshafes with and without nose bushes up to 520mm retracted length.

Empirical method (based on the retracted length).

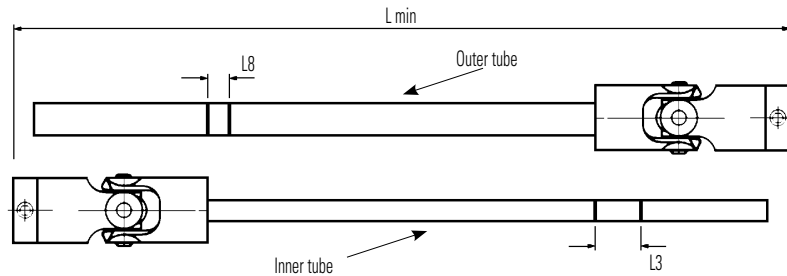

Size	L3	L8
09	0.34 (8.6)	0.13 (3.2)
13	0.41 (10.4)	0.17 (4.3)
16	0.60 (15.2)	0.24 (6.1)
20	0.67 (17.0)	0.32 (8.2)
25	0.79 (20.0)	0.41 (10.3)
32	0.83 (21.0)	0.71 (18.0)

- Disengage the teleshaf, remove the nose bush parked on the inner tube and keep it in case you need to use it later. Then lay the 2 halves of the teleshaf side by side.
- Slide one half alongside the other so that overall length L_{min} matches the intended length of the teleshaf when *fully retracted*. With a felt tip pen, draw a line across the outer tube at the point where this is level with the inboard end of the universal joint.
- If you are sure that the teleshaf will satisfactorily extend the required amount, cut the tube at the line.
- Mark the inner tube in the same way, then add an amount equivalent to dimension L3 for your teleshaf size and draw a second line. Cut the tube at this second line.

- Now re-engage the tubes, taking care to orientate them correctly so that the inboard forks of the joints are in the same plane, and retract the teleshaf. The overall length should be as intended, and both tubes should bottom out simultaneously.
- If required, the nose bush can now be fitted by bonding it to the outer tube with an instant adhesive, (factory fitted bushes are retained by a barbing technique). The bush will add an amount equivalent to dimension L8 to the retracted length. Cutting this amount from the outer tube will reinstate the intended retracted length.
- The purpose of the nose bush is to eliminate any torsional free play that may be apparent in the tubes due to working clearances.

How to order customized teleshafes

Please specify your teleshaf by completing the questionnaire.

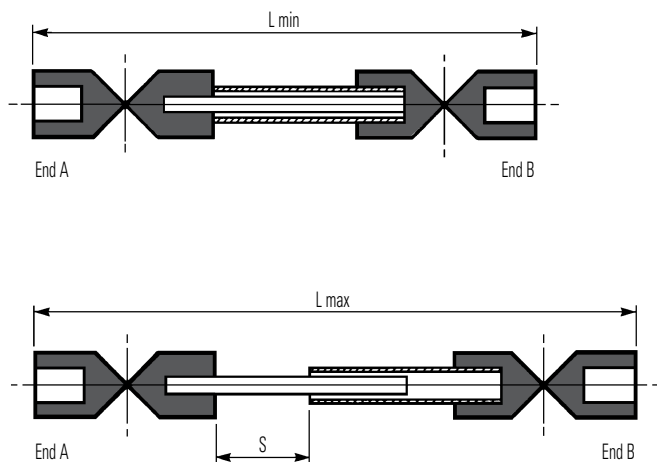

Teleshaf size

Teleshaf ref.

Bore diameter End A

Bore diameter End B

Fitted nose bush (end B only)

Speed of rotation rpm

Please specify:

L min and/or

L max and/or

Stroke S

If more than one parameter is specified, which one is critical?

Please quote pcs

Projected annual qty's pcs



Adjustable Friction Clutches

Huco Vari-Tork are rotary friction devices with adjustable drag or slip torque. Controlled slip takes place between the hub and housing whenever the load exceeds the set torque.

- **Three sizes - up to 3Nm torque capacity**
- **4 interface styles**
- **Set screw or clamp connection**
- **Compact proportions**
- **Use as a torque limiter, tensioning, or overrun device**

The construction is simple and robust and comprises a series of steel clutch plates engaging a hub and a series of friction rings engaging a housing. Pressure is brought to bear on the plates and friction rings by an adjuster acting through a spring and pressure plate. The load can be connected to either the steel inner hub or the aluminium alloy housing.

As a torque limiter, Vari-Tork interrupts continuity between power source and load when this reaches a pre-determined level.

As a tensioning device, Vari-Tork typically maintains tension in a filament or tape winding operation by exerting drag on the feed spool.

As an overrun device, Vari-Tork absorbs residual inertia of a motor when the load is braked or reaches a terminal stop.



Adjustable Friction Clutches



Size 16 Set Screw
Shaft Fixing

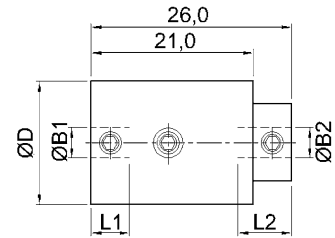

Size 25 Set Screw Shaft Fixing

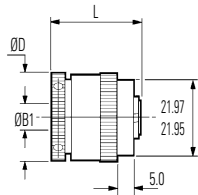

Ref. 271 (2 plate)
279 (6 plate)
Basic clutch (thro' bore)

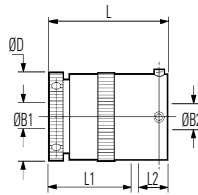

Ref. 273 (2 plate)
281 (6 plate)
Basic clutch + sleeve adaptor

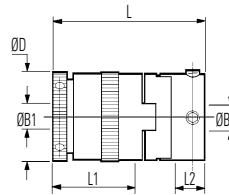

Ref. 277 (2 plate)
285 (6 plate)
Basic clutch + Oldham (set screw) coupling

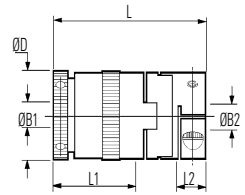

Ref. 267 (2 plate)
269 (6 plate)
Basic clutch + Oldham (clamp) coupling

Size 25 Clamp Shaft Fixing

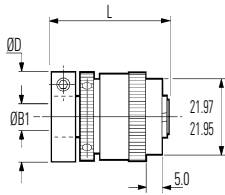

Ref. 401 (2 plate)
409 (6 plate)
Basic clutch (thro' bore)

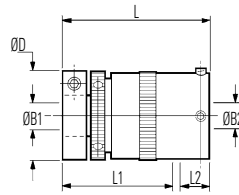

Ref. 403 (2 plate)
411 (6 plate)
Basic clutch + sleeve adaptor

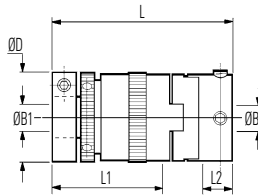

Ref. 407 (2 plate)
415 (6 plate)
Basic clutch + Oldham (set screw) coupling

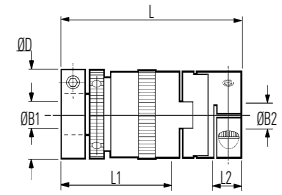

Ref. 397 (2 plate)
399 (6 plate)
Basic clutch + Oldham (clamp) coupling

Size 48 Set Screw Shaft Fixing

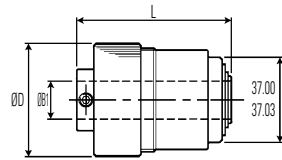

Ref. 279
Basic Clutch (thro' bore)

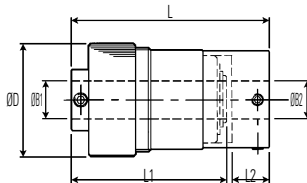

Ref. 281
Basic Clutch + sleeve adaptor

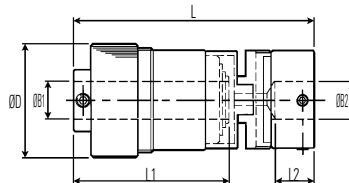

Ref. 285
Basic Clutch + Oldham (set screw) coupling

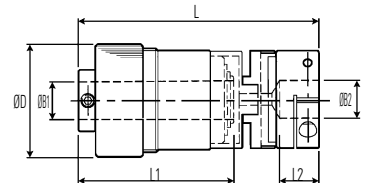

Ref. 269
Basic Clutch + Oldham (clamp) coupling

Materials & Finishes

Housing, adjuster ring, adaptors: Al. Alloy 2014 T6
Irridite NCP finish

Hub: Steel, heat treated

Clutch plates: Size 25 Steel, heat treated
Size 48 Brass

Bearings: Sintered bronze

Fasteners: Alloy steel, black oiled

Adjustable Friction Clutches

DIMENSIONS & ORDER CODES

Size & Model	Set Screw Hub	Clamp Hub	ØD in. (mm)	L in. (mm)	L1 in. (mm)	L2 in. (mm)	ØB1 max in. (mm)	Fasteners at B1 end			ØB2 max in. (mm)	Fasteners at B2 end			Max drag torque lb.-in (Ncm)	Moment of inertia kgm2 x 10-8	Mass kg x 10-3	
								Screw	Torque lb.-in. (Nm)	Wrench in. (mm)		Screw	Torque lb.-in. (Nm)	Wrench in. (mm)				
																		CLUTCH REF
16	311.16	-	0.63 (16.0)	1.89 (26.0)	0.2 (5.0)	0.28 (7.0)	0.16 (4)	M3	0.94	0.06 (1.5)	0.16 (4)	M3	8.32 (0.94)	0.06 (1.5)	0.04 (0.5)	30	14	
	267.25	-		1.83 (46.5)	0.98 (25.0)	0.34 (8.6)						M3	21.5 (2.43)	0.1 (2.5)				416
	271.25	-	1.02 (25.8)	1.04 (26.4)	thro'	-	0.31 (8)	M3	0.94	0.06 (1.5)	-	-	-	-	4.7 (53)	242	37	
	273.25	-		1.42 (36.0)	0.98 (25.0)	0.35 (9.0)					M4	20.09 (2.27)	0.08 (2)	382				50
	25 2-PLATE	277.25	-	1.02 (25.8)	1.83 (46.5)	0.98 (25.0)	0.34 (8.6)	0.31 (8)	M3	2.43	0.1 (2.5)	0.47 (12)	M4	20.09 (2.27)	0.08 (2)	4.7 (53)	317	47
		-	397.25		2.15 (54.5)	3.27 (33.0)	0.34 (8.6)						M3	21.5 (2.43)	0.1 (2.5)			
		-	401.25	1.35 (34.4)	thro'	-	0.31 (8)	M3	2.43	0.1 (2.5)	-	-	-	-	4.7 (53)	441	60	
		-	403.25	1.73 (44.0)	3.27 (33.0)	0.35 (9.0)					M4	20.09 (2.27)	0.08 (2)	511				69
-		407.25	2.15 (54.5)	3.27 (33.0)	0.34 (8.6)	0.31 (8)	M3	2.43	0.1 (2.5)	0.47 (12)	M4	20.09 (2.27)	0.08 (2)	11.6 (132)	529	68		
-		415.25	2.15 (53.4)	1.22 (31.0)	thro'					-	M3	0.94	0.06 (1.5)				-	-
25 6-PLATE	269.25	-	1.02 (25.8)	1.28 (32.4)	thro'	-	0.31 (8)	M3	0.94	0.06 (1.5)	0.47 (12)	M4	20.09 (2.27)	0.08 (2)	11.6 (132)	451	60	
	279.25	-		1.67 (42.5)	1.22 (31.0)	0.35 (9.0)						M4	20.09 (2.27)	0.08 (2)				516
	281.25	-	1.02 (25.8)	2.1 (53.4)	1.22 (31.0)	0.34 (8.6)	0.31 (8)	M3	2.43	0.1 (2.5)	0.47 (12)	M3	21.5 (2.43)	0.1 (2.5)	11.6 (132)	617	79	
	285.25	-		2.39 (60.8)	1.22 (31.0)	0.34 (8.6)						M4	20.09 (2.27)	0.08 (2)				590
	-	399.25	1.6 (40.7)	thro'	-	0.31 (8)	M3	2.43	0.1 (2.5)	-	-	-	-	11.6 (132)	381	58		
	-	409.25	1.98 (50.3)	1.54 (39.0)	0.35 (9.0)					M4	20.09 (2.27)	0.08 (2)	530				71	
	-	411.25	2.39 (60.8)	1.54 (39.0)	0.34 (8.6)	0.31 (8)	M3	2.43	0.1 (2.5)	0.47 (12)	M4	20.09 (2.27)	0.08 (2)	11.6 (132)	590	80		
	-	415.25	2.39 (60.8)	1.54 (39.0)	0.34 (8.6)					M4	20.09 (2.27)	0.08 (2)	590				80	
48 6-PLATE	269.48	-	1.89 (48.0)	4.02 (102.0)	2.56 (65.0)	0.66 (16.7)	0.63 (16)	M6	7.60	0.12 (3.0)	0.79 (20)	M4	50.1 (5.66)	0.12 (3)	26.5 (300)	8037	390	
	279.48	-		2.56 (65.0)	thro'	-						M5	40.89 (4.62)	0.1 (2.5)				7135
	281.48	-	1.89 (48.0)	3.27 (33.0)	2.56 (65.0)	0.63 (16.0)	0.63 (16)	M6	7.60	0.12 (3.0)	0.79 (20)	M5	40.89 (4.62)	0.1 (2.5)	26.5 (300)	8037	390	
	285.48	-		4.02 (102.0)	2.56 (65.0)	0.66 (16.7)						M5	40.89 (4.62)	0.1 (2.5)				8037

PERFORMANCE DATA

Size	Size 16	Size 25	Size 48
Power dissipation at 20°C 2-PLATE 6-PLATE	0.5 watt	7 watts 8.6 watts	18 watts
Backlash	0° max	2° max	zero
Max surface temperature	80° C	80° C	80° C
Max speed continuous slip	1000 rpm	1000 rpm	600 rpm

STANDARD BORES

Sizes indicated in parenthesis are metric (mm).

		ØB1, ØB2 +0.0012/ -0 (+0.03mm/-0mm)															
		(4)	(6)	1/4"	5/16"	(8)	3/8"	(10)	(12)	1/2"	(14)	5/8"	(16)	(18)	(19)	3/4"	(20)
Size 16	At B1 end	●															
	At B2 end	●															
Size 25	At B1 end		●	●	●	●											
	At B2 end		●	●	●	●	●	●	●								
Size 48	At B1 end					●	●	●	●	●	●	●	●	●			
	At B2 end						●	●	●	●	●	●	●	●	●	●	●
Bore ref.		18	22	24	27	28	31	32	35	36	38	41	42	45	46	47	48
Corresponding bore adaptor				253		255		257		259			260				261

Diameters for which a bore adaptor is shown can be adapted to smaller shaft sizes. See page 58 for details

Adjustable Friction Clutches

How to install Vari-Tork

BASIC CLUTCH – REFS. 271, 279, 401 & 409
Controlled slip occurs between pulley and shaft.

Pulley (or gear, etc.) bonded to register. Press fits not permissible.

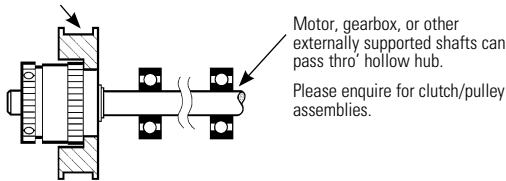

BASIC CLUTCH + SLEEVE ADAPTOR – REFS. 273, 281, 403 & 411
Controlled slip occurs between LH & RH shafts. Clutch orientation not important, supported shaft may be entered either end.

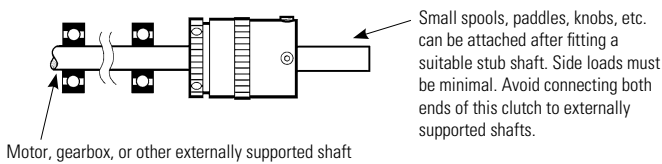

BASIC CLUTCH + FLEXIBLE COUPLING - REFS. 267, 269, 277, 285, 397, 399, 407 & 415 Controlled slip occurs between LH & RH shafts.

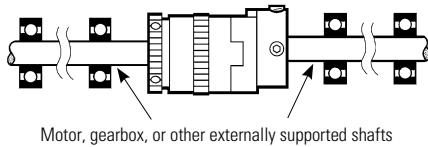

Locking ring

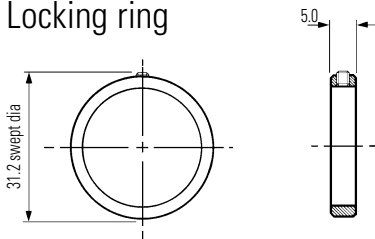

order ref.

294.25

size 25 only

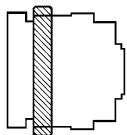

Fit locking ring flush with end of housing as shown. Lightly tension locking screw to secure the adjuster.
Wrench size 1.5

Vari-Tork characteristics

The characteristics of dry plate clutches favour those applications which can tolerate relatively imprecise drag torques. Three tendencies should be noted:

BREAKAWAY TORQUE

After a period during which no slipping has taken place, the breakaway torque can be up to 2^{1/2} times the set value.

TORQUE DECAY

There is an inverse relationship between clutch temperature and slipping torque. The slipping torque reduces from the set value as the power being dissipated causes the clutch temperature to rise. When slipping continuously, torque settles at approximately 70% of the value set on a new clutch and at approximately 80% of the value set on a used clutch. This characteristic is not speed-dependent.

SPEED RELATED TORQUE FLUCTUATIONS

Variations in slipping speed cause a momentary increase in the prevailing output torque. The clutches behave more consistently at high speed/low torque than at low speed/high torque. High speed in this instance starts at approximately 500 rpm.

Where applications call for sustained slipping, the housing temperature should be maintained below 80°C. Clutches mounted concentrically within pulleys, gear wheels, etc. will be more effective at dissipating heat generated during slipping.

CALCULATING FOR POWER DISSIPATION

Given the slipping speed in rpm and the drag torque in Nm, the following equation can be used for calculating the power dissipation in watts (W).

$$W = \frac{Nm \cdot rpm}{9.55}$$

Locking ring

In some circumstances it is possible for the adjuster ring to unscrew during operation. The adjuster ring can be secured by fitting locking ring ref. **294.25**.

Removing the adjuster ring

- 1) If this should be necessary, be sure to replace the pressure plate first, then the spring washers. Ensure that the topmost friction ring is fully engaged with the splines. *A disengaged friction ring will cause the clutch to malfunction.*
- 2) To remove the adjuster ring, first remove the clamp. With set screw hubs the adjuster ring cannot be removed if the set screws protrude above the hub diameter. Flattening or dimpling of shafts is recommended and may be necessary with shafts larger than Ø6.35 to avoid the screws fouling the adjuster ring.

Waved washers

Two waved washers are fitted to these clutches. In some instances, better torque control may result from removing one of them, particularly when working in the lower torque ranges.

Construction - Size 25 Vari-Tork

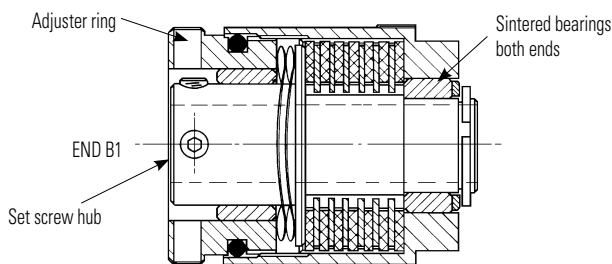

Sectional view of 6-plate Vari-Tork Ref. 279.25 Shafts are secured by set screws accessed through radial holes in the adjuster ring.

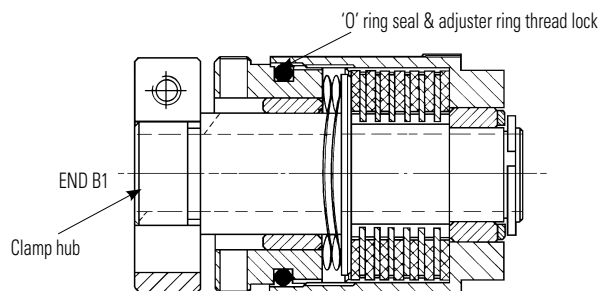

Sectional view of 6-plate Vari-Tork Ref. 409.25 Shafts are secured by a split hub and ring clamp method which does not score the shafts.



Bore Adaptors

Bore adaptors offer a convenient way of adapting a coupling to a variety of shaft diameters, typically at the R & D stage. A range of motor options, for example, can be accommodated with one coupling and a selection of Huco-Loks.

When fitted to set screw hubs, adaptors prevent the screws from scoring the shafts and permit repeated re-positioning and easy removal of the coupling.

The adaptors feature a feathered head which sits in the chamfer at the bore entry and prevents over-insertion.

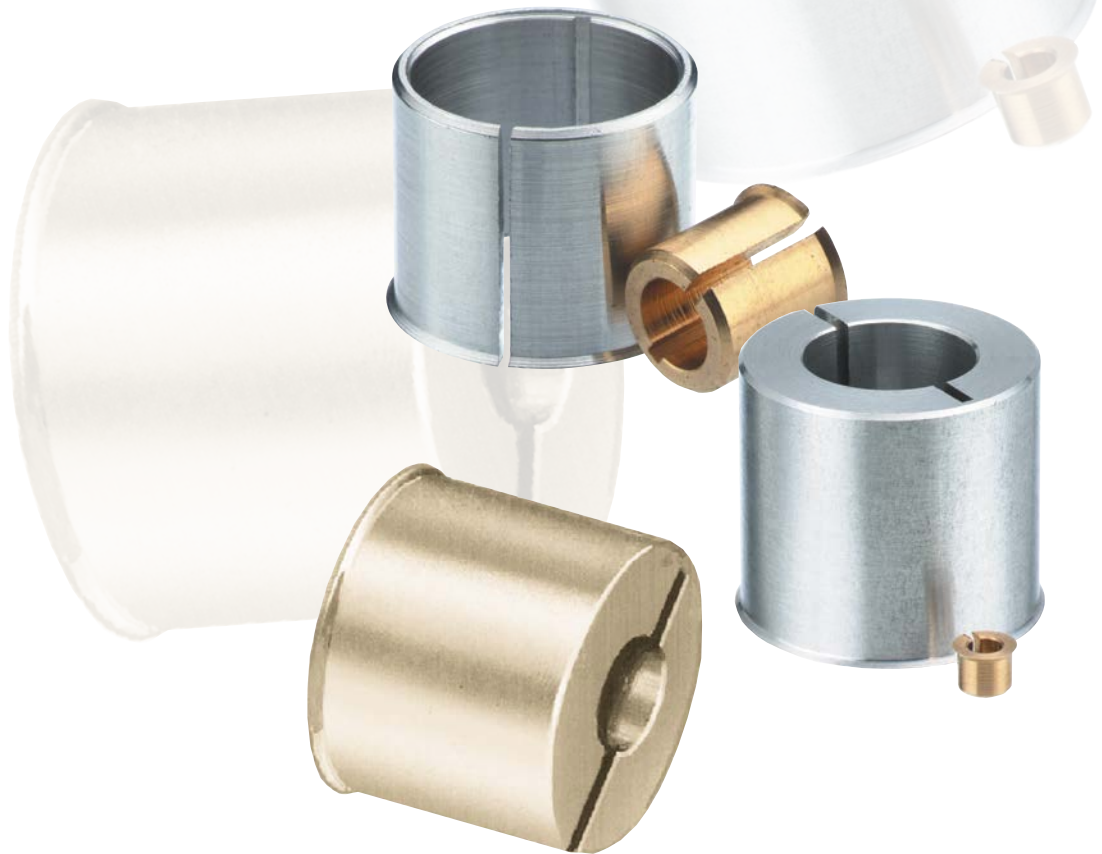

Metal (non insulating) bore adaptors

Sizes indicated in parenthesis are metric (mm).

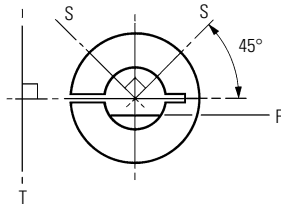
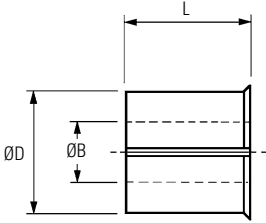

Bore For optimum fastening, install HUCO-LOK bore adaptors as shown.

'S' represents screws in set screw hub.

'T' represents tangential screw in clamp hub.

'F' shows recommended orientation of flattened shaft in set screw hub.

Note that both traction and concentricity may be affected when using an adaptor. For best results shafts with h6 tolerance or better, are recommended. Undersized shafts become progressively less effective. For similar reasons, flattened shafts with more than 1/4 of their diameter removed are not recommended.

Cat ref.	251	253	*254	255	257	259	260	261
ØD in.	(5)	1/4"	(8)	(8)	(10)	1/2"	(16)	(20)
L in.	0.17 (4.3)	0.26 (6.6)	0.23 (5.8)	0.32 (8.1)	0.32 (8.1)	0.42 (10.7)	0.52 (13.2)	0.79 (20)
to fit bores coded	20	24	28	28	32	36	42	48
minor ØB	Adaptor ref.							
(2)	251.11	253.11						
(3)	251.14	253.14	254.14	255.14				
.120"	251.15	253.15	254.15	255.15				
1/8"	251.16	253.16	254.16	255.16				
(4)	251.18	253.18	254.18	255.18				
3/16"		253.19	254.19	255.19				
(5)		253.20	254.20	255.20				
(6)			254.22	255.22	257.22			
1/4"					257.24	259.24	260.24	
(7)					257.25	259.25	260.25	
(8)					257.28	259.28	260.28	261.28
(9)						259.30	260.30	261.30
(10)						259.32	260.32	261.32
(11)							260.33	261.33
(12)							260.35	261.35
(14)							260.38	261.38
(15)								261.40
(16)								261.42
(18)								261.45
material	brass				aluminium alloy			



Formula and Conversion Factors for Motion Transfer

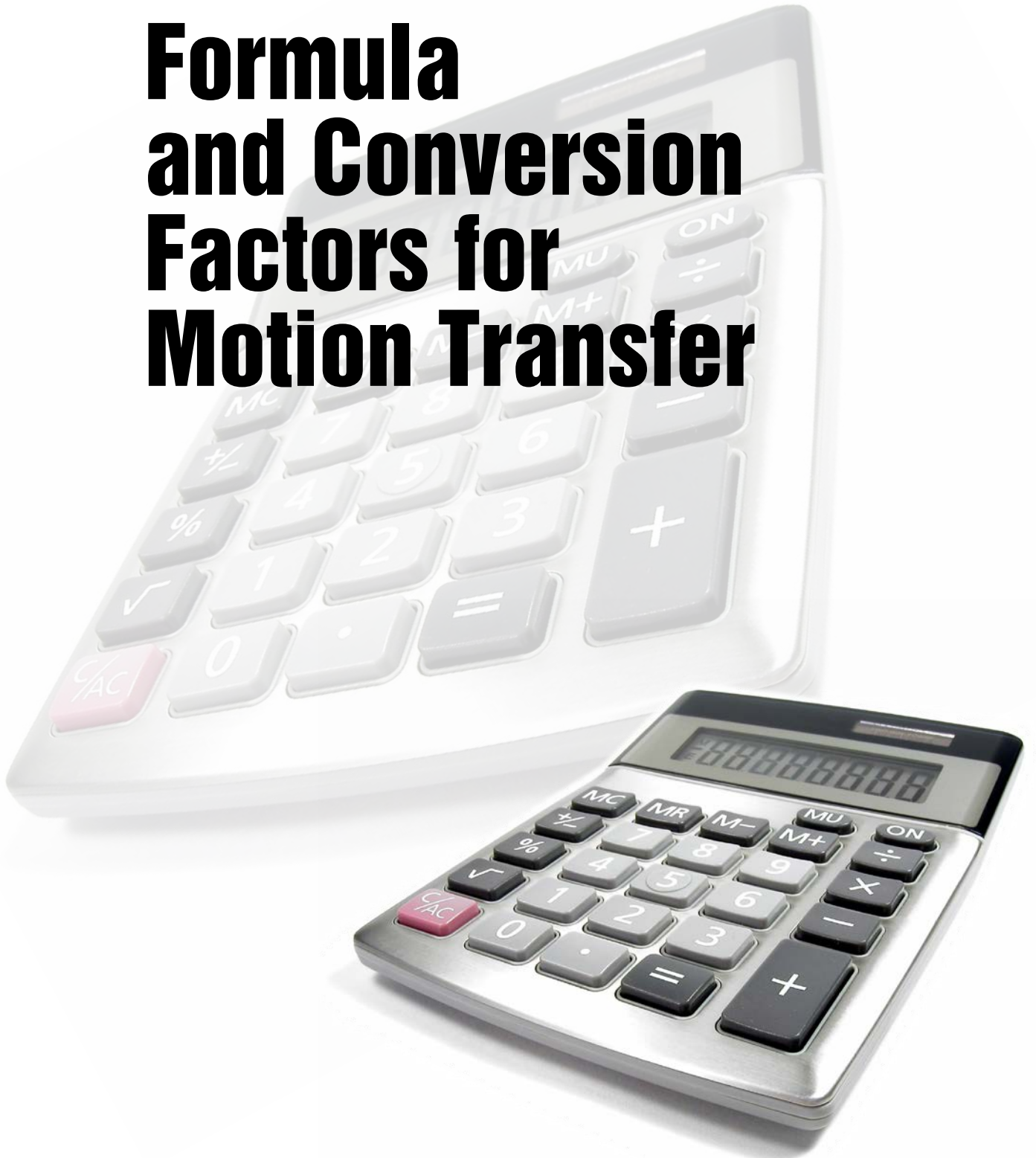

Formula and Conversion Factors

SI BASE UNITS

Quantity	Unit Symbol	Name
length	m	meter
mass	kg	kilogram
time	s	second
electric current	A	ampere
Thermodynamic temperature	K	kelvin
luminous intensity	cd	candela

LETTER SYMBOLS & SI UNITS IN POWER TRANSMISSION ENGINEERING

Symbol	Quantity	SI Unit Symbol	Name
Mechanics			
E	modulus of elasticity (Young's modulus)	Pa	pascal
F	force	N	Newton
G (W)	weight	N	Newton
J	moment of inertia	kgm ²	kilogram meter squared
M (T)	torque	Nm	Newton meter
m	mass	kg	kilogram
P	power	W	watt
p	pressure	Pa	pascal
ρ	density (mass density)	kg/m ³	-
σ	stress	Pa	pascal
W (E)	work (energy)	J	joule
η	efficiency	1	-
μ	coefficient of friction	1	-

FORMULAE

International System(SI)

Imperial System (FPS)

POWER

Lifting motion
$P = \frac{m \cdot g \cdot v}{\eta \cdot 1000}$
Linear motion
$P = \frac{F_r \cdot v}{1000}$
$F_r = \mu \cdot m \cdot g$
Rotary motion
$P = \frac{M \cdot n}{9550}$
P - Power in kW
F _r - Frictional resistance in N
m - Mass in kg
g - Acceleration of free fall (9.81) in m/s ²
v - Velocity in m/s
η - Efficiency in decimals
μ - Coefficient of friction
M - Torque in Nm
n - Rotational speed in 1/min or r/min

Lifting motion
$P = \frac{W \cdot v}{\eta \cdot 33000}$
Linear motion
$P = \frac{F_r \cdot v}{33000}$
$F_r = \mu \cdot W$
Rotary motion
$P = \frac{M \cdot n}{5250}$
P - Power in hp
F _r - Frictional resistance in lbf
W - Weight in lb
v - Velocity in ft/min
η - Efficiency in decimals
μ - Coefficient of friction
M - Torque in lbf . ft
n - Rotational speed in rpm

International System(SI)

Imperial System (FPS)

TORQUE

M - F . r
$P = \frac{9550 \cdot P}{n}$
M - Torque in Nm
F - Force in N
r - Radius of lever in m
P - Power in kW
n - Rotational speed in 1/min or r/min

M - F . r
$P = \frac{5250 \cdot P}{n}$
M - Torque in lbf . ft
F - Force in lbf
r - Radius of lever in ft
P - Power in hp
n - Rotational speed in rpm

WORK

W - F . s = m . g . s
$W = \frac{j \cdot n^2}{182.5}$
W - Work (energy) in Nm = Ws = J
F - Force in N
s - Length of path in m
m - Mass in kg
g - Acceleration of free fall (9.81) in m/s ²
J - Moment of inertia in kgm ²
n - Rotational speed in 1/min or r/min

W - F . s
$W = \frac{WK^2 \cdot n^2}{5880}$
W - Work (energy) in lb . ft
F - Force in lbf
s - Length of path in ft
m - Mass in kg
g - Acceleration of free fall (9.81) in m/s ²
WK- Flywheel effect lb . ft ²
n - Rotational speed in rpm

ACCELERATION OR BRAKING TIME

$t_a = \frac{j \cdot n}{9.55 M_a}$
t _a - Acceleration or braking time in s
J - Moment of inertia in kgm ²
n - Rotational speed in 1/min or r/min
M _a - Acceleration or braking torque in Nm

$t_a = \frac{WK^2 \cdot n}{308 M_a}$
t _a - Acceleration or braking time in s
WK- Flywheel effect in kgm ²
n - Rotational speed in rpm
M _a - Acceleration or braking torque in lb . ft

MOMENT OF INERTIA

Solid Cylinder
$J = \frac{1}{2} \cdot m \cdot r_{ext}^2$
$= \frac{1}{32} \cdot 1000 \cdot \pi \cdot \rho \cdot l \cdot d_{ext}^4$
$= 98 \rho \cdot l \cdot d_{ext}^4$
Hollow Cylinder
$J = \frac{1}{2} \cdot m \cdot (r_{ext}^2 + r_{int}^2)$
$= \frac{1}{32} \cdot 1000 \cdot \pi \cdot \rho \cdot l \cdot (d_{ext}^4 - d_{int}^4)$
$= 98 \cdot \rho \cdot l \cdot (d_{ext}^4 - d_{int}^4)$

Solid Cylinder
$WK^2 = \frac{1}{2} \cdot W \cdot r_{ext}^2$
$= \frac{\pi}{32} \cdot \rho \cdot l \cdot d_{ext}^4$
$= 0.1 \rho \cdot l \cdot d_{ext}^4$
Hollow Cylinder
$WK^2 = \frac{1}{2} \cdot W \cdot (r_{ext}^2 + r_{int}^2)$
$= \frac{\pi}{32} \cdot \rho \cdot l \cdot (d_{ext}^4 - d_{int}^4)$
$= 0.1 \cdot \rho \cdot l \cdot (d_{ext}^4 - d_{int}^4)$

torsional stiffness and resonant frequency

$$C_T \leq \frac{(F_R \times 2 \pi)^2}{\left(\frac{1}{J_M} + \frac{1}{J_L} \right)} \quad FR \leq \frac{1}{2 \pi} \times \sqrt{\left(\frac{1}{J_M} + \frac{1}{J_L} \right)} \times C_T$$

Where
C_T = torsional stiffness (Nm/rad);
J_M = motor inertia (kgm²)
F_R = resonant frequency (Hz)
J_L = load inertia (kgm²)

Formula and Conversion Factors

FORCE

		N	kp	p	tonf (UK)	lbf	ozf
1N	=	1	0.1020	102.0	100.4×10^{-6}	0.2248	3.597
1kp	=	9.807	1	1000	0.984×10^{-3}	2.205	35.27
1p	=	9.81×10^{-3}	1×10^{-3}	1	0.984×10^{-6}	2.2×10^{-3}	35.3×10^{-3}
1tonf (UK)	=	9964	1016	1.02×10^6	1	2240	35.8×10^3
1lbf	=	4.448	0.4536	453.6	0.5×10^{-9}	1	16
1ozf	=	-	28.4×10^{-3}	28.35	27.9×10^{-6}	62.5×10^{-3}	1

VELOCITY

		km/h	m/min	m/s	mile/h	ft/min	ft/s	in/s
1km/h	=	1	16.667	0.2778	0.6214	54.68	0.9113	10.936
m/min	=	0.06	1	16.7×10^{-3}	37.3×10^{-3}	3.281	54.7×10^{-3}	0.656
1m/s	=	3.6	60	1	2.237	196.85	3.281	39.37
1mile/h	=	1.609	26.82	0.4470	1	88	1.467	17.6
1ft/min	=	18.3×10^{-3}	0.3048	5.08×10^{-3}	11.4×10^{-3}	1	16.7×10^{-3}	0.2
1ft/s	=	1.097	18.288	0.3048	0.6818	60	1	12
1in/s	=	91×10^{-3}	1.524	25.4×10^{-3}	56.8×10^{-3}	5	83.3×10^{-3}	1

TORQUE

		Nm	Ncm	kgfm	lbf.ft	lbf.in	ozf.in
1Nm	=	1	100	0.10197	0.73756	8.8507	141.61
Ncm	=	0.01	1	1.02×10^{-3}	7.376×10^{-3}	88.5×10^{-3}	1.4161
1kgfm	=	9.8067	980.67	1	7.233	86.796	1389
1lbf.ft	=	1.356	135.6	0.1383	1	12	192
1lbf.in	=	0.1129	11.29	11.5×10^{-3}	83.3×10^{-3}	1	16
1ozf.in	=	7.062×10^{-3}	0.7062	0.72×10^{-3}	5.21×10^{-3}	62.5×10^{-3}	1

POWER

		kW	PS	hp	kgfm/s	ft.lbf/s
1kW	=	1	1.360	1.341	102.0	737.6
1PS	=	0.7355	1	0.9863	75	542.5
1hp	=	0.7457	1.014	1	76.04	550
1kgfm/s	=	9.81×10^{-3}	13.33×10^{-3}	13.15×10^{-3}	1	7.233
1ft.lbf/s	=	1.36×10^{-3}	1.84×10^{-3}	1.82×10^{-3}	0.1383	1

MOMENT OF INERTIA AND OTHER FLYWHEEL EFFECTS

		kgm ² (<i>mr</i> ²)	kgfm ² (<i>GD</i> ²)	lb.ft ² (<i>WK</i> ²)	kpms ²	ft lbf s ²
1kgm ² (<i>mr</i> ²)	=	1	4	23.73	0.102	0.7376
1kgfm ² (<i>GD</i> ²)	=	0.25	1	5.933	25×10^{-3}	0.1844
1lb.ft ² (<i>WK</i> ²)	=	42.1×10^{-3}	0.1686	1	4.30×10^{-3}	31.1×10^{-3}
1kpms ²	=	9.807	39.23	232.7	1	7.233
1ft lbf s ²	=	1.356	5.423	32.17	0.1383	1

LENGTH

	mm	m	in	ft	yds	km	miles
1mm	1	0.001	0.3937	0.0033	0.00109	-	-
1m	1000	1	39.370	3.2808	1.0936	0.001	0.0006215
1in	25.4	0.0254	1	0.0833	0.0277	0.0000254	0.0000158
1ft	304.8	0.3048	12	1	0.3333	0.000304	0.0001894
1yd	914.4	0.9144	36	3	1	0.000914	0.000568
1km	-	1000	39,370.07	3,280.83	1,093.613	1	0.6215
1mile	-	1,609	63,346.45	5,278.87	1,759.623	1.609	1

All Customer Service phone numbers shown in bold

Belted Drives and Sheaves

TB Wood's

Belted Drives
Chambersburg, PA - USA
1-888-829-6637 – Press #5
For application assistance:
1-888-829-6637 – Press #7

Couplings

Ameridrives Couplings

Mill Spindles, Ameriflex, Ameridisc
Erie, PA - USA
1-814-480-5000

Gear Couplings
San Marcos, TX - USA
1-800-458-0887

Ameridrives Power Transmission

Universal Joints, Drive Shafts, Mill Gear Couplings
Green Bay, WI - USA
1-920-593-2444

Bibby Turboflex

Disc, Gear, Grid Couplings, Overload Clutches
Dewsbury, England
+44 (0) 1924 460801
Boksburg, South Africa
+27(0) 11 918 4270

Guardian Couplings

Engineered Flywheel Couplings, Engine Housings and Pump Mounts, Flexible Shaft Couplings
Michigan City, IN - USA
1-219-874-5248

Huco Dynatork

Precision Couplings and Air Motors
Hertford, England
+44 (0) 1992 501900
Chambersburg, PA - USA
1-888-829-6637

Couplings Cont.

Lamiflex Couplings

Flexible Couplings, Bearing Isolators, and Coupling Guards
Cotia, SP - Brasil
+55 (11) 4615-6300

TB Wood's

Elastomeric Couplings
Chambersburg, PA - USA
1-888-829-6637 – Press #5
For application assistance:
1-888-829-6637 – Press #7
General Purpose Disc Couplings
San Marcos, TX - USA
1-888-449-9439

Electromagnetic Clutches and Brakes

Inertia Dynamics

Spring Set Brakes; Power On and Wrap Spring Clutch/Brakes
New Hartford, CT - USA
1-800-800-6445

Matrix International

Electromagnetic Clutches and Brakes, Pressure Operated Clutches and Brakes
Brechin, Scotland
+44 (0) 1356 602000
New Hartford, CT - USA
1-800-825-6544

Warner Electric

Electromagnetic Clutches and Brakes
New Hartford, CT - USA
1-800-825-6544
For application assistance:
1-800-825-9050
Saint Barthélemy d'Anjou, France
+33 (0)2 41 21 24 24
Precision Electric Coils and Electromagnetic Clutches and Brakes
Columbia City, IN - USA
1-260-244-6183

Engineered Bearing Assemblies

Kilian Manufacturing

Engineered Bearing Assemblies
Syracuse, NY - USA
1-315-432-0700

Gearing

Bauer Gear Motor

Geared Motors
Esslingen, Germany
+49 (711) 3518-0
Somerset, NJ - USA
1-732-469-8770

Boston Gear

Enclosed and Open Gearing, Electrical and Mechanical P.T. Components
Charlotte, NC - USA
1-800-825-6544
For application assistance:
1-800-816-5608

Nuttall Gear and Delroyd Worm Gear

Worm Gear and Helical Speed Reducers
Niagara Falls, NY - USA
1-716-298-4100

Heavy Duty Clutches and Brakes

Industrial Clutch

Pneumatic and Oil Immersed Clutches and Brakes
Waukesha, WI - USA
1-262-547-3357

Svendborg Brakes

Industrial Brakes and Brake Systems
Vejstrup, Denmark
+45 63 255 255

Twiflex Limited

Caliper Brakes and Thrusters
Wichita Falls, TX - USA
1-844-723-3483
Twickenham, England
+44 (0) 20 8894 1161

Heavy Duty Clutches and Brakes Cont.

Wichita Clutch

Pneumatic Clutches and Brakes
Wichita Falls, TX - USA
1-800-964-3262
Bedford, England
+44 (0) 1234 350311

Linear Products

Warner Linear

Linear Actuators
Belvidere, IL - USA
1-800-825-6544
For application assistance:
1-800-825-9050
Saint Barthélemy d'Anjou, France
+33 (0)2 41 21 24 24

Overrunning Clutches

Formsprag Clutch

Overrunning Clutches and Holdbacks
Warren, MI - USA
1-800-348-0881 – Press #1
For application assistance:
1-800-348-0881 – Press #2

Marland Clutch

Roller Ramp and Sprag Type Overrunning Clutches and Backstops
South Beloit, IL - USA
1-800-216-3515

Stieber Clutch

Overrunning Clutches and Holdbacks
Heidelberg, Germany
+49 (0) 6221-30470

For information concerning our sales offices in Asia Pacific check our website www.altramotion.com.cn



www.huco.com

440 North Fifth Avenue
Chambersburg, PA 17201 - USA
888-829-6637
Fax: 717-264-6420

Merchant Drive, Hertford
Hertfordshire, SG13 7BL - England
+44 (0)1992 501900
Fax: +44 (0)1992 509890