

99189

Dimensions

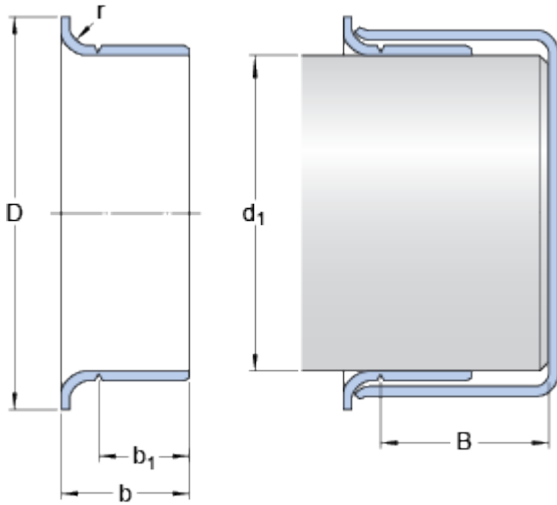

Nominal dimensions

d_1		48	mm
D		56.007	mm
Tolerance outside diameter D	\pm	1.6	mm
b		16.967	mm
Tolerance width b	\pm	0.8	mm
b_1		13.995	mm
Tolerance width b_1	\pm	0.8	mm
B	max.	24.994	mm
r	max.	3.18	mm

Shaft diameter range

d_1	min.	47.93	mm
d_1	max.	48.082	mm