

Bracket

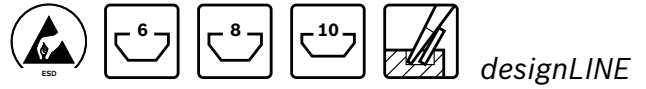

- ▶ Bracket with centering lugs for quick, precise and twist-resistant installation
- ▶ The centering lugs can simply be broken off for assembly on plates or at an angle to the slot
- ▶ *DesignLINE* version with special silver paint (RAL 9006) for an especially high-quality design
- ▶ Adapter for positioning brackets in the next largest slot
- ▶ Sliding block offset for off-center positioning of the 45/45 bracket
- ▶ Cover cap to protect from dirt, available in signal grey (RAL 7004) and black ESD (RAL 9005)
- ▶ Profile machining: not required



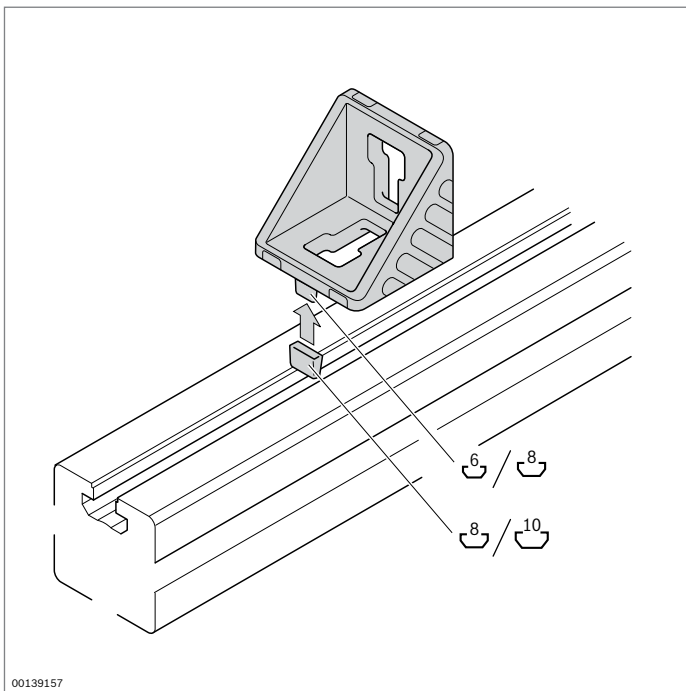

Technical data (p. 19-9)

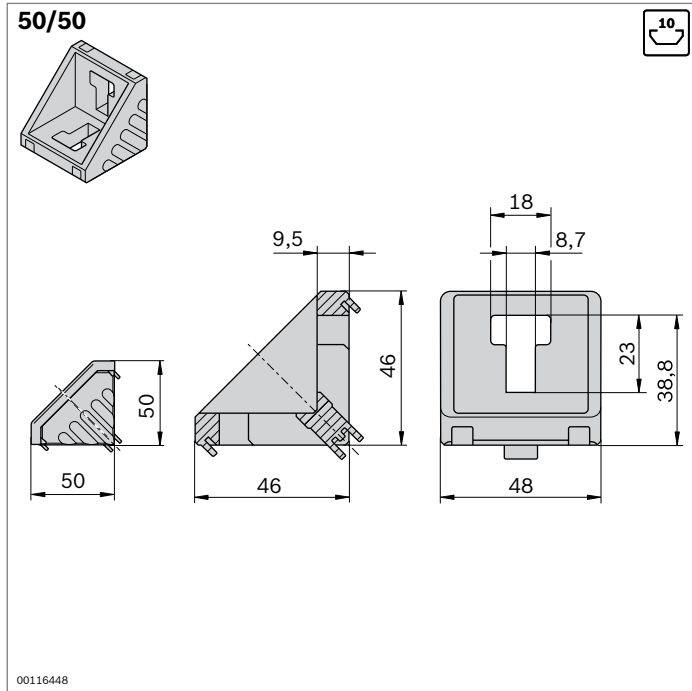
Notice: The collar screws enable the brackets to be assembled really quickly and easily (p. 3-5)

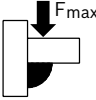
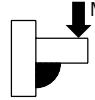
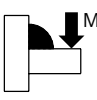
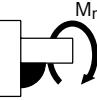



Model				
50/50	4000 N	125 Nm	250 Nm	38 Nm

50/50	Slot	ESD		No.	FS
Set (standard)	10 / 10		1	3 842 530 259	2xFS7
Bracket (standard)	10		20	3 842 530 381	
Cover cap, signal grey			20	3 842 548 870	
Cover cap, black			20	3 842 548 871	

Material: Bracket: diecast aluminum, vibratory ground

Cover cap: PP



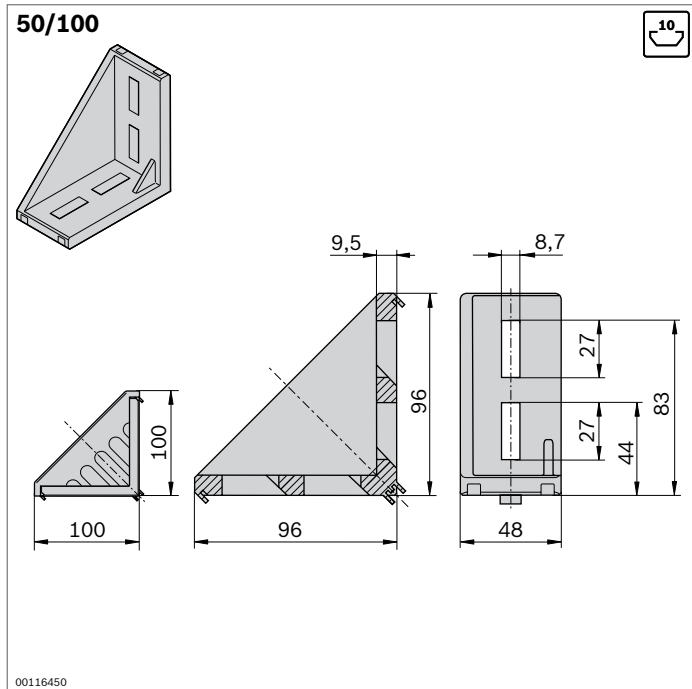
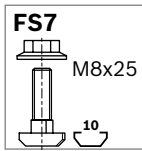

Fastening material: Steel, galvanized

Scope of delivery:

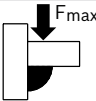
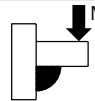
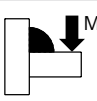
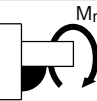
Set Incl. fastening material (FS)



Model				
50/100	7500 N	300 Nm	600 Nm	73 Nm

50/100	Slot	ESD		No.	FS
Set (standard)	10 / 10		1	3 842 530 260	4xFS7
Bracket (standard)	10		20	3 842 530 382	
Cover cap, signal grey			20	3 842 548 872	
Cover cap, black			20	3 842 548 873	

Material: Bracket: diecast aluminum, vibratory ground

Cover cap: PP

Fastening material: Steel, galvanized

Scope of delivery:

Set Incl. fastening material (FS)

