

NEW

ARCA Cabinet



Protection in demanding environments

IP 66

+80 °C

-40 °C





FIBOX ARCA cabinets

Fibox is a brand name synonymous with the manufacture and global supply of the highest quality enclosure solutions for use in harsh and demanding environments since 1966.

A testament to the fact that our enclosures are built to withstand the rigours of the global climate is examples of our EK range, the first produced by Fibox back in the 60's, can still be seen today doing exactly what they were designed to do..... protect!

The bedrock to Fibox' continuing success is a two-fold philosophy. Firstly, a sound knowledge of the demands of the markets in which we operate, and secondly, injection moulding and engineering innovation unrivalled in the enclosure industry.

The word "partner" is taken very seriously in Fibox. Our aim is to become a partner to you, our customer. But to do that we must offer you more than just an enclosure. That is why our sales teams will work alongside you to produce an enclosure solution which is tailored exactly to your requirement. Whether it is a simple gland entry or extremely complex customising involving special components or assembly, Fibox has the capability to deliver a solution which is sympathetic to the many and varied links in your value chain. We fully understand it is not all about the product and other factors are equally as important.

This catalogue is dedicated to Fibox ARCA IEC, a brand new range of robust Polycarbonate wall mounting cabinets which typifies the innovation and market driven approach to new product development highlighted earlier. Over 2 years in the making, ARCA is a first, and the market now has what it has demanded.....a viable and cost effective alternative to the many sheet steel cabinets which are being installed in totally unsuitable environments. In a nutshell, all the features of steel but the benefits of high grade thermoplastic.

Just take a look below at a few of the many features you will see in more detail further into the catalogue;

- Non corrosive
- IP66 ingress protection
- IK10 Impact resistance
- A multitude of locking options
- Aesthetic design
- UV stabilised
- Can be safely machined without conductive swarf residue, in situ or in the workshop
- Smooth surface for graphics and components

The Fibox ARCA IEC range in this catalogue carries on the tradition set by the ARCA JIC product family introduced in North America in 2007. This has in a short period of time become the product being seen as the benchmark in this very discerning market. We are confident this innovative new range will have a similar impact.

We trust you will find the basis of your wall mounting cabinet requirement in this catalogue. We then look forward to your invitation to assist you in making it your exact requirement.

Fibox operates globally, so wherever in the world you are, a Fibox representative is close by!

The Fibox team

FIBOX web services

Always up-to-date

Please visit www.fibox.com regularly to find out the latest developments from the Fibox team. Fibox is continuously launching new products and improving services in the pursuit of helping its customers to succeed. Fibox prides itself in supplying high quality products with excellent service. Besides orders shipped correctly and on time, excellent service also means providing an extensive package of design aids and technical information about Fibox products and services.

Engineering assistance

Selecting the right enclosure for your application is made easier with clear, easily accessible technical and engineering data.

At www.fibox.com you can obtain detailed technical information about enclosures including photos, raw material specifications, dimensional drawings and CAD files. Additionally, Fibox also offers copies of regulatory agency approvals and certificates in pdf format.

CAD drawings

Fibox supports engineers, designers and buyers with full CAD drawings either in 2D or 3D formats. Engineering time and costs can significantly be reduced by using easily accessible Fibox 3D models, which are widely used globally. All CAD files can be downloaded at www.fibox.com.

Download catalogues and leaflets

At www.fibox.com you find a variety of brochures and catalogues in pdf format. Please visit our web site at www.fibox.com to download the latest catalogues and leaflets.

Around the world

As a global company Fibox has currently full web services in Chinese, Danish, Dutch, English, Finnish, French, German, Japanese, Korean, Polish, Russian and Swedish.

Let us know how we can improve

Please give us feedback. Contact us via www.fibox.com or email at info@fibox.fi. We are committed to improve our service to you. Please help us by sharing your opinions to make Fibox World even better.

www.fibox.com

FIBOX customizing services

FIBOX machining services

To increase the range and flexibility of our enclosure solutions, Fibox has developed a comprehensive range of services, permitting cost effective customization for specific applications. The two most important of these are machining services and customized tooling.

Our sophisticated CNC machinery can supply enclosures with holes, cutouts and openings to your specification. This solution is best suited for small to medium volumes of enclosures. Fibox knowledge of enclosure materials ensures that the machining method is compatible with the chosen enclosure material.

Prior to machining a production run, product specification and drawings need to be prepared. Either the customer or Fibox can create these drawings. Enclosure specifications and technical data are available at www.fibox.com. CAD support 2D-drawings are available in IGES, DWG and DXF formats and 3D-models in IGES and Parasolid formats adaptable to your design system requirements.

Assembly services

Many enclosure solutions utilize Fibox accessories to improve the functionality of the enclosure system. Fibox can provide assembly services and install accessories specified by the end user, allowing delivery of "ready to use" mechanical packaging assemblies, saving labour costs and speeding up the manufacturing process. The Fibox accessory program includes a large number of items ranging from hinges and latches, cable glands and wiring accessories, to inspection windows and ventilators.

Customized tooling

For large volume OEM requirements, it is often possible to customize the moulding of a standard product to meet the OEM's specific needs. Provided the mould is a sophisticated multiple slide mould, any enclosure side may be customized without requiring an entirely new mould. It is important that the OEM consult with Fibox early in their design process to determine what, if any, mould change restrictions exist.

Altering an existing Fibox mould can be a very cost effective alternative to creating a custom mould. In essence, you lease a high volume, standard product mould with minimal initial tooling cost. This can shorten product development times and permit customizing even those products with projected short life cycles. Your new product reaches the market sooner.

Coloured plastic enclosures

Fibox offers custom moulding of standard enclosures in customer specified colours. Standard colour specifications are based upon RAL system, however custom colour matching is possible. The type of plastic has significant impact on colour match, colour consistency and cost. Please consult your Fibox representative for guidance. Custom colour moulding becomes economical in volumes over 1000 pieces, but lower volumes are also possible. Cost adders are based upon increased raw material costs, plus the cost to prepare moulds prior to production and then clean the moulds and injection machines after production. These mould preparation costs are highly volume dependent.

Painted enclosures

Painting enclosures is recommended for plastic enclosures when volumes do not justify custom moulding. Critical colour matching, if required, is also easier to accomplish with paint. Paint type is dependent upon the choice of enclosure material. Please consult your Fibox representative for guidance.

EMC - plastic enclosures

Plastic enclosures can be prepared to provide EMC shielding. Various methods are available, but painting the internal surface with Cu paint is the preferred method. This coating, combined with a conductive gasket material such as CHO-SEAL 1350, can provide significant shielding levels. Proper selection of materials is very application specific. Please consult your Fibox representative for guidance.























Printed enclosures

Silk screen printing is recommended for enclosure batches of less than 1000 pieces. This method is mainly suitable for flat surfaces, and can be used for large areas. Tampo printing is the best solution for volumes greater than 1000 pieces. It is suitable for printing on both flat and curved surfaces of limited size. Tampo printing is also ideal for tight spots like the inside surface of the enclosure.

The IP and IK classifications

Ingress protection class of enclosures is given in the form of IP classification, a two digit coding which is shown below. Fibox has tested the enclosures according to EN 60529. The standard requires the second digit to be tested from class 6 upwards separately to each level of class, thus the double marking IP 66 / IP 67 indicates that the actual tests have been made for both levels.

The new European standard for empty enclosures, EN 62208 includes the IK impact test too. This test is described in EN 62262, and as Fibox enclosures are tested to EN 62208, the data for impact resistance will be available as well.

FIRST DIGIT Protection against solid objects			SECOND DIGIT Protection against liquids			IK CODE Protection against mechanical impacts		
IP	TEST		IP	TEST		IK	TEST	
0		no protection	0		no protection	00		no protection
1		protected against solid objects up to 50 mm e.g. to 50 mm e.g. hands	1		protected against vertically falling drops of water	01-05		impact < 1 joule
2		protected against solid objects up to 12 mm e.g. fingers	2		protected against direct sprays of water up to 15° from the vertical	06		impact 1 joule
3		protected against solid objects over 2,5 mm (tools+ small wires)	3		protected against water sprayed from all directions - limited ingress permitted	07		impact 2 joule
4		protected against solid objects over 1 mm (tools+ small wires)	4		protected against water sprayed from all directions - limited ingress permitted	08		impact 5 joule
5		protected against dust - limited ingress permitted (no harmful deposit)	5		protected against low pressure jets of water from all directions - limited ingress permitted	09		impact 10 joule
6		totally protected against dust	6		protected against strong jets of water e.g. for use on shipdecks - limited ingress permitted	10		impact 20 joule
			7		protected against the effects of immersion between 15 cm and 1 m			
			8		protected against long periods of immersion under pressure			

ARCA cabinets

Long-lasting solution for harsh and demanding environments

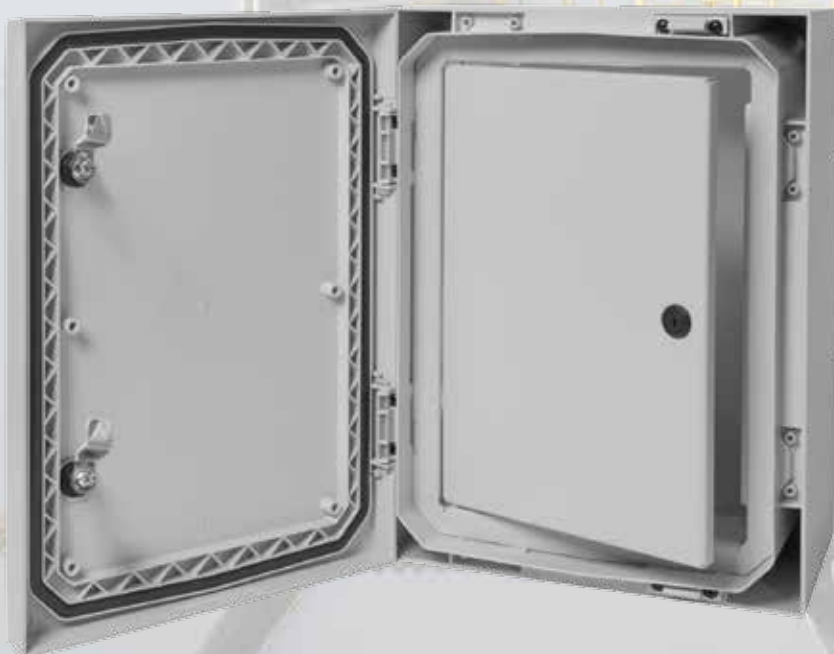

Door

- Door opening angle 120°
- Both horizontal and vertical option
- Pre-formed fixing studs inside
- Easy access to the contents
- Door stop available



Patent pending hinge design

- Easy assembly and refined appearance



Declined design on base

- Better waterproof

Locking

- Double-bit
- Changeable lock inserts



Mounting pods

- On the base, cover and four base sides



Gasket

- Wide and secured gasket with PUR material for high quality sealing.

Special molded rib design

- For making the cabinet extra stabile and solid



Corner design

- Double corner to secure fixing without destroying the IP
- Robust and rigid cabinet

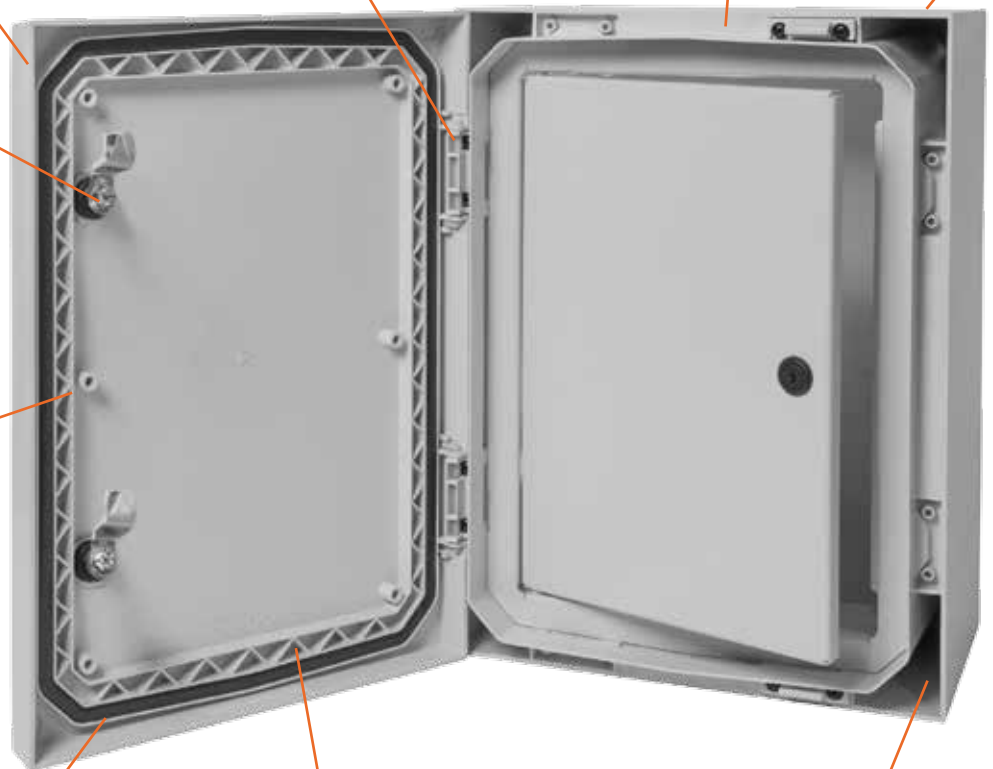

Base

The main body of the Fibox ARCA cabinet is made from rugged polycarbonate which offers many benefits;

- Non corrosive
- High impact resistance
- Low maintenance
- UV resistant
- Aesthetically pleasing

Mounting plate

- Galvanized steel as standard
- Pertinax and perforated galvanized steel on request



DIN rail frame set *

- Including DIN rail frame, front plate, corner brackets and screws for installation
- Easy and quick installation
- Patent pending



Adjustable mounting plate *

- Easy to assemble the mounting plate to desired depth with special corner brackets.

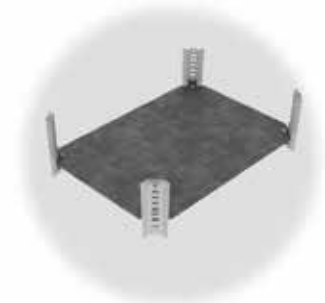

Inner door *

- No tools needed for installation
- Lockable
- Patent pending



Window cover *



Wall mounting lugs *

- 2 depths (10 and 40 mm) in stainless 316 steel



Swing handle *

- Secure 3-point closing with swing handle
- Changeable lock inserts



Flanges *

- Membrane, thread and smooth flange plates
- Multiple cable entry features



Door guide *

- Secure closing for bigger cabinet sizes



*Accessory. Sold separately.

ARCA IEC ARCA 2030

200 x 300

PC: IP66, IK 10



Including: Cabinet base, door with PUR gasket, mounting plate, screws for mounting plate. 3 mm double bit lock(s) with key. S versions with swinghandle 3-point locking system. F versions with flange opening. Door guide included.

Cabinets

Order Symbol	Code	Dimensions	Description
ARCA 203015	8120020	200 x 300 x 150	Cabinet, PC ▪ Grey cover, 1-point locking, hinges on the short side
ARCA 203015S	8120100	200 x 300 x 150	Cabinet, PC ▪ Grey cover, swinghandle, hinges on the short side
ARCA 203015W	8120140	200 x 300 x 150	Cabinet, PC ▪ Grey cover with window, 1-point locking, hinges on the short side
ARCA 203015SW	8120220	200 x 300 x 150	Cabinet, PC ▪ Grey cover with window, swinghandle, hinges on the short side
ARCA 203015F	8120260	200 x 300 x 150	Cabinet, PC, flange ▪ Grey cover, 1-point locking, hinges on the short side
ARCA 203015SF	8120340	200 x 300 x 150	Cabinet, PC, flange ▪ Grey cover with window, swinghandle, hinges on the short side
ARCA 203015WF	8120380	200 x 300 x 150	Cabinet, PC, flange ▪ Grey cover with window, 1-point locking, hinges on the short side
ARCA 203015SWF	8120460	200 x 300 x 150	Cabinet, PC, flange ▪ Grey cover with window, swinghandle, hinges on the short side

Accessories

Order Symbol	Code	Dimensions	Description
MPS ARCA 3020	8120731	250 x 150	Mounting plate ▪ Galvanized steel, for size 300x200x150
MPP ARCA 3020	8120751	250 x 150	Mounting plate perforated ▪ Galvanized steel, for size 300x200x150
MPX ARCA 3020	8120741	250 x 150	Mounting plate ▪ Pertinax, for size 300x200x150
DRS ARCA 203015	8120791		DIN rail frame set ▪ 1 row x 11 modules, for size 200x300x150
PMK ARCA 30	8120840		Pole mounting kit ▪ For size 200x300x150, 400x300x150/210

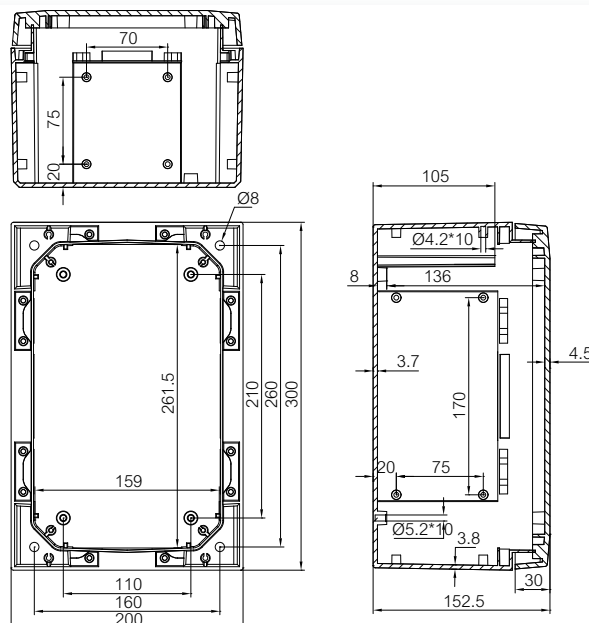



ARCA IEC ARCA 3020

300 x 200

PC: IP66, IK 10

Including: Cabinet base, door with PUR gasket, mounting plate, screws for mounting plate. 3 mm double bit lock(s) with key. S versions with swinghandle 3-point locking system. F versions with flange opening. Door guide included.

Cabinets

Order Symbol	Code	Dimensions	Description
ARCA 302015	8120002	300 x 200 x 150	Cabinet, PC ▪ Grey cover, 1-point locking, hinges on the long side
ARCA 302015S	8120082	300 x 200 x 150	Cabinet, PC ▪ Grey cover, swinghandle, hinges on the long side
ARCA 302015W	8120122	300 x 200 x 150	Cabinet, PC ▪ Grey cover with window, 1-point locking, hinges on the long side
ARCA 302015SW	8120202	300 x 200 x 150	Cabinet, PC ▪ Grey cover with window, swinghandle, hinges on the long side
ARCA 302015F	8120242	300 x 200 x 150	Cabinet, PC, flange ▪ Grey cover, 1-point locking, hinges on the long side
ARCA 302015SF	8120322	300 x 200 x 150	Cabinet, PC, flange ▪ Grey cover with window, swinghandle, hinges on the long side
ARCA 302015WF	8120362	300 x 200 x 150	Cabinet, PC, flange ▪ Grey cover with window, 1-point locking, hinges on the long side
ARCA 302015SWF	8120442	300 x 200 x 150	Cabinet, PC, flange ▪ Grey cover with window, swinghandle, hinges on the long side

Accessories

Order Symbol	Code	Dimensions	Description
MPS ARCA 3020	8120731	250 x 150	Mounting plate ▪ Galvanized steel, for size 300x200x150
MPP ARCA 3020	8120751	250 x 150	Mounting plate perforated ▪ Galvanized steel, for size 300x200x150
MPX ARCA 3020	8120741	250 x 150	Mounting plate ▪ Pertinax, for size 300x200x150
DRS ARCA 302015	8120760		DIN rail frame set ▪ 1 row x 5 modules, for size 300x200x150
IDS ARCA 3020	8120711		Inner door set ▪ Galvanized steel, for size 300x200x150
PMK ARCA 20	8120841		Pole mounting kit ▪ For sizes 300x200x150

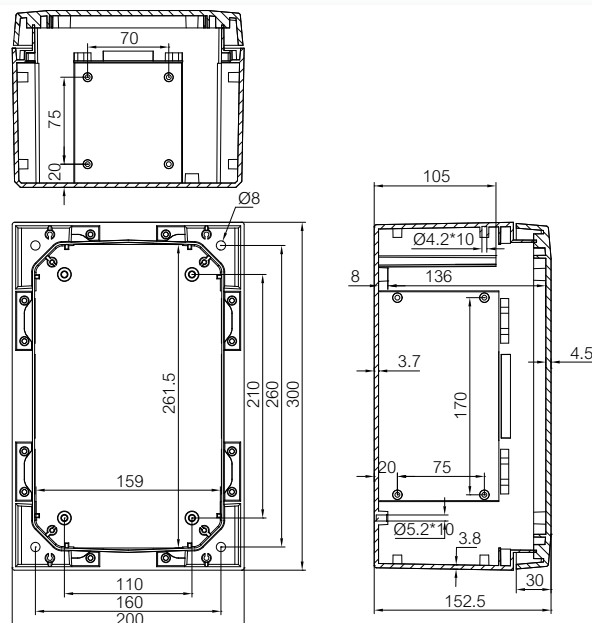

ARCA IEC ARCA 3040

300 x 400

PC: IP66, IK 10



Including: Cabinet base, door with PUR gasket, mounting plate, screws for mounting plate. 3 mm double bit lock(s) with key. S versions with swinghandle 3-point locking system. F versions with flange opening. Door guide included.

Cabinets

Order Symbol	Code	Dimensions	Description
ARCA 304015	8120022	300 x 400 x 150	Cabinet, PC ▪ Grey cover, 2-point locking, hinges on the short side
ARCA 304021	8120023	300 x 400 x 210	Cabinet, PC ▪ Grey cover, 2-point locking, hinges on the short side
ARCA 304015S	8120102	300 x 400 x 150	Cabinet, PC ▪ Grey cover, swinghandle, hinges on the short side
ARCA 304021S	8120103	300 x 400 x 210	Cabinet, PC ▪ Grey cover, swinghandle, hinges on the short side
ARCA 304015W	8120142	300 x 400 x 150	Cabinet, PC ▪ Grey cover with window, 2-point locking, hinges on the short side
ARCA 304021W	8120143	300 x 400 x 210	Cabinet, PC ▪ Grey cover with window, 2-point locking, hinges on the short side
ARCA 304015SW	8120222	300 x 400 x 150	Cabinet, PC ▪ Grey cover with window, swinghandle, hinges on the short side
ARCA 304021SW	8120223	300 x 400 x 210	Cabinet, PC ▪ Grey cover with window, swinghandle, hinges on the short side
ARCA 304015F	8120262	300 x 400 x 150	Cabinet, PC, flange ▪ Grey cover, 2-point locking, hinges on the short side
ARCA 304021F	8120263	300 x 400 x 210	Cabinet, PC, flange ▪ Grey cover, 2-point locking, hinges on the short side
ARCA 304015SF	8120342	300 x 400 x 150	Cabinet, PC, flange ▪ Grey cover with window, swinghandle, hinges on the short side
ARCA 304021SF	8120343	300 x 400 x 210	Cabinet, PC, flange ▪ Grey cover with window, swinghandle, hinges on the short side
ARCA 304015WF	8120382	300 x 400 x 150	Cabinet, PC, flange ▪ Grey cover with window, 2-point locking, hinges on the short side
ARCA 304021WF	8120383	300 x 400 x 210	Cabinet, PC, flange ▪ Grey cover with window, 2-point locking, hinges on the short side
ARCA 304015SWF	8120462	300 x 400 x 150	Cabinet, PC, flange ▪ Grey cover with window, swinghandle, hinges on the short side
ARCA 304021SWF	8120463	300 x 400 x 210	Cabinet, PC, flange ▪ Grey cover with window, swinghandle, hinges on the short side

Accessories

Order Symbol	Code	Dimensions	Description
MPS ARCA 4030	8120733	350 x 250	Mounting plate ▪ Galvanized steel, for sizes 400x300x150/210
MPP ARCA 4030	8120753	350 x 250	Mounting plate perforated ▪ Galvanized steel, for sizes 400x300x150/210
MPX ARCA 4030	8120743	350 x 250	Mounting plate ▪ Pertinax, for sizes 400x300x150/210
DRS ARCA 304015	8120793		DIN rail frame set ▪ 1 row x 16 modules, for size 300x400x150
DRS ARCA 304021	8120794		DIN rail frame set ▪ 1 row x 16 modules, for size 300x400x210
PMK ARCA 40	8120841		Pole mounting kit ▪ For sizes 300x400x150/210, 500x400x210

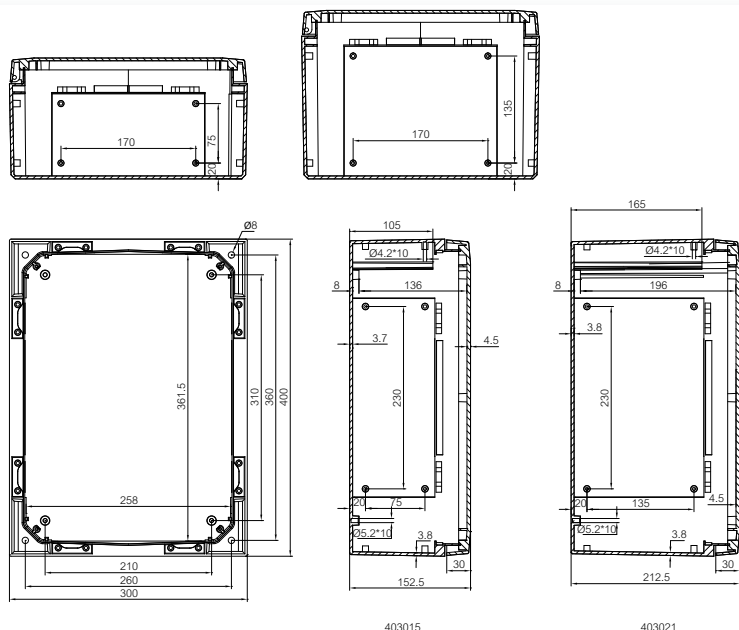



ARCA IEC ARCA 4030

400 x 300

PC: IP66, IK 10

Including: Cabinet base, door with PUR gasket, mounting plate, screws for mounting plate. 3 mm double bit lock(s) with key. S versions with swinghandle 3-point locking system. F versions with flange opening. Door guide included.

Cabinets

Order Symbol	Code	Dimensions	Description
ARCA 403015	8120006	400 x 300 x 150	Cabinet, PC ▪ Grey cover, 2-point locking, hinges on the long side
ARCA 403015S	8120086	400 x 300 x 150	Cabinet, PC ▪ Grey cover, swinghandle, hinges on the long side
ARCA 403015W	8120126	400 x 300 x 150	Cabinet, PC ▪ Grey cover with window, 2-point locking, hinges on the long side
ARCA 403015SW	8120206	400 x 300 x 150	Cabinet, PC ▪ Grey cover with window, swinghandle, hinges on the long side
ARCA 403015F	8120246	400 x 300 x 150	Cabinet, PC, flange ▪ Grey cover, 2-point locking, hinges on the long side
ARCA 403015SF	8120326	400 x 300 x 150	Cabinet, PC, flange ▪ Grey cover with window, swinghandle, hinges on the long side
ARCA 403015WF	8120366	400 x 300 x 150	Cabinet, PC, flange ▪ Grey cover with window, 2-point locking, hinges on the long side
ARCA 403015SWF	8120446	400 x 300 x 150	Cabinet, PC, flange ▪ Grey cover with window, swinghandle, hinges on the long side
ARCA 403021	8120007	400 x 300 x 210	Cabinet, PC ▪ Grey cover, 2-point locking, hinges on the long side
ARCA 403021S	8120087	400 x 300 x 210	Cabinet, PC ▪ Grey cover, swinghandle, hinges on the long side
ARCA 403021W	8120127	400 x 300 x 210	Cabinet, PC ▪ Grey cover with window, 2-point locking, hinges on the long side
ARCA 403021SW	8120207	400 x 300 x 210	Cabinet, PC ▪ Grey cover with window, swinghandle, hinges on the long side
ARCA 403021F	8120247	400 x 300 x 210	Cabinet, PC, flange ▪ Grey cover, 2-point locking, hinges on the long side
ARCA 403021SF	8120327	400 x 300 x 210	Cabinet, PC, flange ▪ Grey cover with window, swinghandle, hinges on the long side
ARCA 403021WF	8120367	400 x 300 x 210	Cabinet, PC, flange ▪ Grey cover with window, 2-point locking, hinges on the long side
ARCA 403021SWF	8120447	400 x 300 x 210	Cabinet, PC, flange ▪ Grey cover with window, swinghandle, hinges on the long side

Accessories

Order Symbol	Code	Dimensions	Description
MPS ARCA 4030	8120733	350 x 250	Mounting plate ▪ Galvanized steel, for sizes 400x300x150/210
MPP ARCA 4030	8120753	350 x 250	Mounting plate perforated ▪ Galvanized steel, for sizes 400x300x150/210
MPX ARCA 4030	8120743	350 x 250	Mounting plate ▪ Pertinax, for sizes 400x300x150/210
DRS ARCA 403015	8120764		DIN rail frame set ▪ 2 rows x 11 modules, for size 400x300x150
DRS ARCA 403021	8120765		DIN rail frame set ▪ 2 rows x 11 modules, for size 400x300x210
IDS ARCA 4030	8120713		Inner door set ▪ Galvanized steel, for sizes 400x300x150/210
PMK ARCA 30	8120842		Pole mounting kit ▪ For sizes 200x300x150, 400x300x150/210

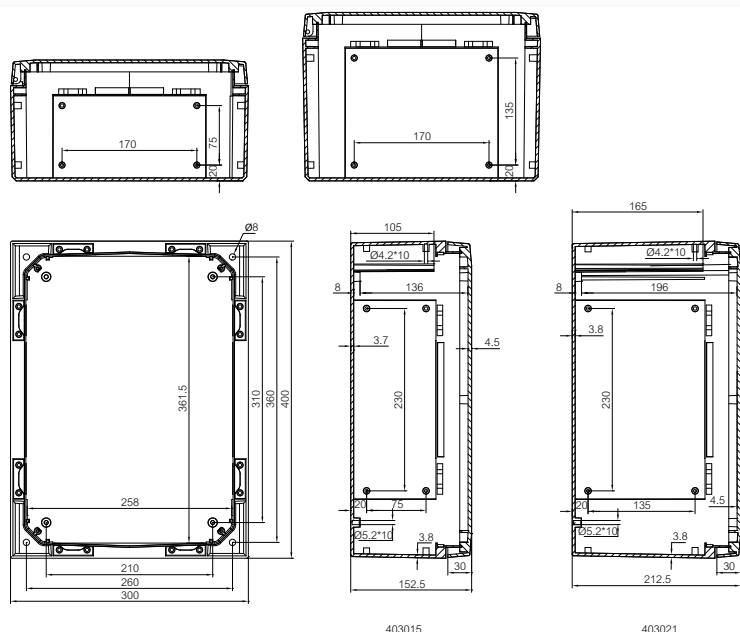

ARCA IEC ARCA 4050

400 x 500

PC: IP66, IK 10



Including: Cabinet base, door with PUR gasket, mounting plate, screws for mounting plate. 3 mm double bit lock(s) with key. S versions with swinghandle 3-point locking system. F versions with flange opening. Door guide included.

Cabinets

Order Symbol	Code	Dimensions	Description
ARCA 405021	8120025	400 x 500 x 210	Cabinet, PC ▪ Grey cover, 2-point locking, hinges on the short side
ARCA 405021S	8120105	400 x 500 x 210	Cabinet, PC ▪ Grey cover, swinghandle, hinges on the short side
ARCA 405021W	8120145	400 x 500 x 210	Cabinet, PC ▪ Grey cover with window, 2-point locking, hinges on the short side
ARCA 405021SW	8120225	400 x 500 x 210	Cabinet, PC ▪ Grey cover with window, swinghandle, hinges on the short side
ARCA 405021F	8120265	400 x 500 x 210	Cabinet, PC, flange ▪ Grey cover, 2-point locking, hinges on the short side
ARCA 405021SF	8120345	400 x 500 x 210	Cabinet, PC, flange ▪ Grey cover with window, swinghandle, hinges on the short side
ARCA 405021WF	8120385	400 x 500 x 210	Cabinet, PC, flange ▪ Grey cover with window, 2-point locking, hinges on the short side
ARCA 405021SWF	8120465	400 x 500 x 210	Cabinet, PC, flange ▪ Grey cover with window, swinghandle, hinges on the short side

Accessories

Order Symbol	Code	Dimensions	Description
MPS ARCA 5040	8120735	450 x 350	Mounting plate ▪ Galvanized steel, for size 500x400x210
MPP ARCA 5040	8120755	450 x 350	Mounting plate perforated ▪ Galvanized steel, for size 500x400x210
MPX ARCA 5040	8120745	450 x 350	Mounting plate ▪ Pertinax, for size 500x400x210
DRS ARCA 405021	8120796		DIN rail frame set ▪ 2 rows x 22 modules, for size 400x500x210
PMK ARCA 50	8120842		Pole mounting kit ▪ For sizes 400x500x210, 700x500x300

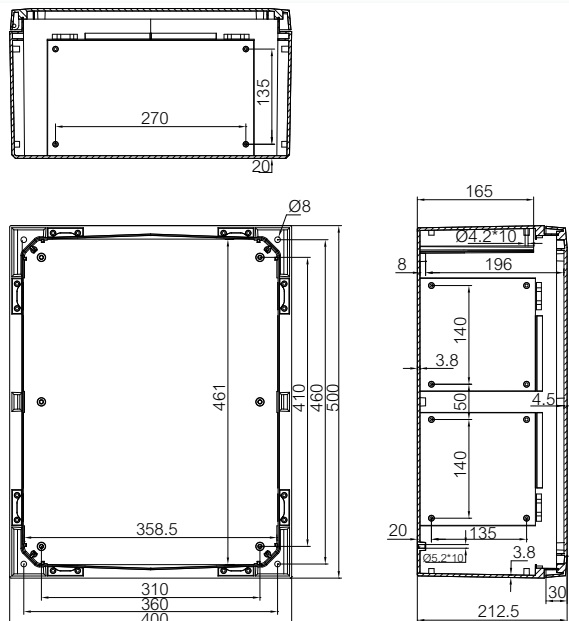



ARCA IEC ARCA 5040

500 x 400

PC: IP66, IK 10

Including: Cabinet base, door with PUR gasket, mounting plate, screws for mounting plate. 3 mm double bit lock(s) with key. S versions with swinghandle 3-point locking system. F versions with flange opening. Door guide included.

Cabinets

Order Symbol	Code	Dimensions	Description
ARCA 504021	8120011	500 x 400 x 210	Cabinet, PC ▪ Grey cover, 2-point locking, hinges on the long side
ARCA 504021S	8120091	500 x 400 x 210	Cabinet, PC ▪ Grey cover, swinghandle, hinges on the long side
ARCA 504021W	8120131	500 x 400 x 210	Cabinet, PC ▪ Grey cover with window, 2-point locking, hinges on the long side
ARCA 504021SW	8120211	500 x 400 x 210	Cabinet, PC ▪ Grey cover with window, swinghandle, hinges on the long side
ARCA 504021F	8120251	500 x 400 x 210	Cabinet, PC, flange ▪ Grey cover, 2-point locking, hinges on the long side
ARCA 504021SF	8120331	500 x 400 x 210	Cabinet, PC, flange ▪ Grey cover with window, swinghandle, hinges on the long side
ARCA 504021WF	8120371	500 x 400 x 210	Cabinet, PC, flange ▪ Grey cover with window, 2-point locking, hinges on the long side
ARCA 504021SWF	8120451	500 x 400 x 210	Cabinet, PC, flange ▪ Grey cover with window, swinghandle, hinges on the long side

Accessories

Order Symbol	Code	Dimensions	Description
MPS ARCA 5040	8120735	450 x 350	Mounting plate ▪ Galvanized steel, for size 500x400x210
MPP ARCA 5040	8120755	450 x 350	Mounting plate perforated ▪ Galvanized steel, for size 500x400x210
MPX ARCA 5040	8120745	450 x 350	Mounting plate ▪ Pertinax, for size 500x400x210
DRS ARCA 504021	8120769		DIN rail frame set ▪ 3 rows x 16 modules, for size 500x400x210
IDS ARCA 5040	8120715		Inner door set ▪ Galvanized steel, for size 500x400x210
PMK ARCA 40	8120843		Pole mounting kit ▪ For sizes 300x400x150/210, 500x400x210

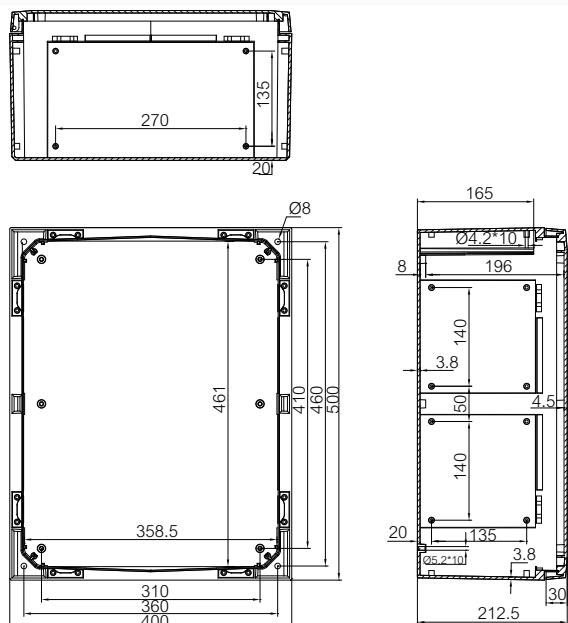

ARCA IEC ARCA 4060

400 x 600

PC: IP66, IK 10



Including: Cabinet base, door with PUR gasket, mounting plate, screws for mounting plate. 3 mm double bit lock(s) with key. S versions with swinghandle 3-point locking system. F versions with flange opening. Door guide included.

Cabinets

Order Symbol	Code	Dimensions	Description
ARCA 406021	8120026	400 x 600 x 210	Cabinet, PC ▪ Grey cover, 2-point locking, hinges on the short side
ARCA 406021S	8120106	400 x 600 x 210	Cabinet, PC ▪ Grey cover, swinghandle, hinges on the short side
ARCA 406021W	8120146	400 x 600 x 210	Cabinet, PC ▪ Grey cover with window, 2-point locking, hinges on the short side
ARCA 406021SW	8120226	400 x 600 x 210	Cabinet, PC ▪ Grey cover with window, swinghandle, hinges on the short side
ARCA 406021F	8120266	400 x 600 x 210	Cabinet, PC, flange ▪ Grey cover, 2-point locking, hinges on the short side
ARCA 406021SF	8120346	400 x 600 x 210	Cabinet, PC, flange ▪ Grey cover with window, swinghandle, hinges on the short side
ARCA 406021WF	8120386	400 x 600 x 210	Cabinet, PC, flange ▪ Grey cover with window, 2-point locking, hinges on the short side
ARCA 406021SWF	8120466	400 x 600 x 210	Cabinet, PC, flange ▪ Grey cover with window, swinghandle, hinges on the short side

Accessories

Order Symbol	Code	Dimensions	Description
MPS ARCA 6040	8120736	550 x 350	Mounting plate ▪ Galvanized steel, for size 600x400x210
MPP ARCA 6040	8120756	550 x 350	Mounting plate perforated ▪ Galvanized steel, for size 600x400x210
MPX ARCA 6040	8120746	550 x 350	Mounting plate ▪ Pertinax, for size 600x400x210
DRS ARCA 406021	8120797		DIN rail frame set ▪ 2 rows x 27 modules, for size 400x600x210
PMK ARCA 60	8120842		Pole mounting kit ▪ For sizes 400x600x210, 800x600x300

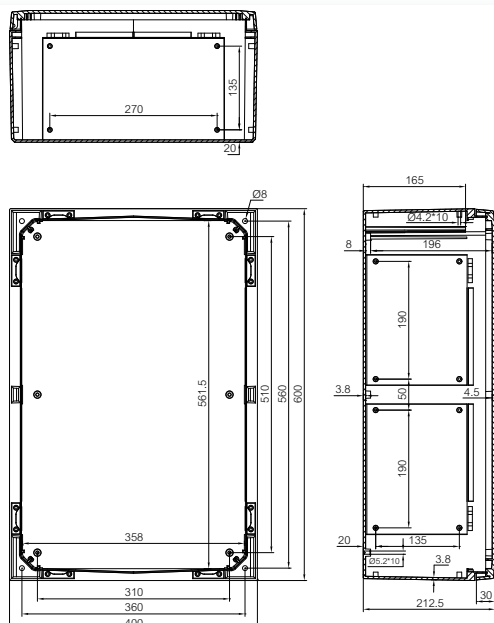



ARCA IEC ARCA 6040

600 x 400

PC: IP66, IK 10

Including: Cabinet base, door with PUR gasket, mounting plate, screws for mounting plate. 3 mm double bit lock(s) with key. S versions with swinghandle 3-point locking system. F versions with flange opening. Door guide included.

Cabinets

Order Symbol	Code	Dimensions	Description
ARCA 604021	8120012	600 x 400 x 210	Cabinet, PC ▪ Grey cover, 2-point locking, hinges on the long side
ARCA 604021S	8120092	600 x 400 x 210	Cabinet, PC ▪ Grey cover, swinghandle, hinges on the long side
ARCA 604021W	8120132	600 x 400 x 210	Cabinet, PC ▪ Grey cover with window, 2-point locking, hinges on the long side
ARCA 604021SW	8120212	600 x 400 x 210	Cabinet, PC ▪ Grey cover with window, swinghandle, hinges on the long side
ARCA 604021F	8120252	600 x 400 x 210	Cabinet, PC, flange ▪ Grey cover, 2-point locking, hinges on the long side
ARCA 604021SF	8120332	600 x 400 x 210	Cabinet, PC, flange ▪ Grey cover with window, swinghandle, hinges on the long side
ARCA 604021WF	8120372	600 x 400 x 210	Cabinet, PC, flange ▪ Grey cover with window, 2-point locking, hinges on the long side
ARCA 604021SWF	8120452	600 x 400 x 210	Cabinet, PC, flange ▪ Grey cover with window, swinghandle, hinges on the long side

Accessories

Order Symbol	Code	Dimensions	Description
MPS ARCA 6040	8120736	550 x 350	Mounting plate ▪ Galvanized steel, for size 600x400x210
MPP ARCA 6040	8120756	550 x 350	Mounting plate perforated ▪ Galvanized steel, for size 600x400x210
MPX ARCA 6040	8120746	550 x 350	Mounting plate ▪ Pertinax, for size 600x400x210
DRS ARCA 604021	8120770		DIN rail frame set ▪ 3 rows x 16 modules, for size 600x400x210
IDS ARCA 6040	8120716		Inner door set ▪ Galvanized steel, for size 600x400x210
PMK ARCA 40	8120844		Pole mounting kit ▪ For sizes 300x400x150/210, 500x400x210

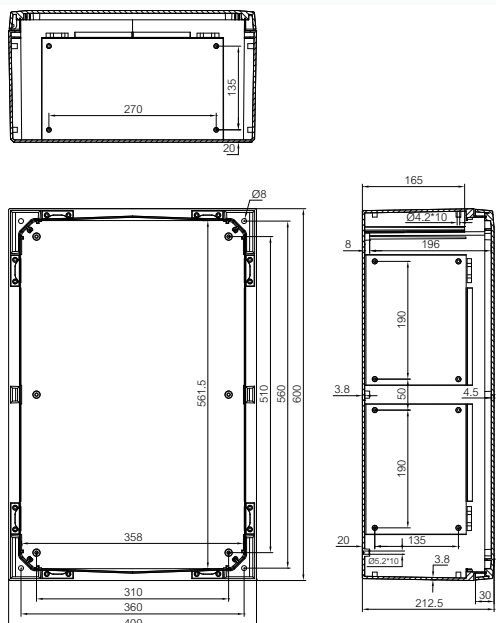

ARCA IEC ARCA 5070

500 x 700

PC: IP66, IK 10



Including: Cabinet base, door with PUR gasket, mounting plate, screws for mounting plate. 3 mm double bit lock(s) with key. S versions with swinghandle 3-point locking system. F versions with flange opening. Door guide included.

Cabinets

Order Symbol	Code	Dimensions	Description
ARCA 507030	8120031	500 x 700 x 300	Cabinet, PC ▪ Grey cover, 2-point locking, hinges on the short side
ARCA 507030S	8120111	500 x 700 x 300	Cabinet, PC ▪ Grey cover, swinghandle, hinges on the short side
ARCA 507030W	8120151	500 x 700 x 300	Cabinet, PC ▪ Grey cover with window, 2-point locking, hinges on the short side
ARCA 507030SW	8120231	500 x 700 x 300	Cabinet, PC ▪ Grey cover with window, swinghandle, hinges on the short side
ARCA 507030F	8120271	500 x 700 x 300	Cabinet, PC, flange ▪ Grey cover, 2-point locking, hinges on the short side
ARCA 507030SF	8120351	500 x 700 x 300	Cabinet, PC, flange ▪ Grey cover with window, swinghandle, hinges on the short side
ARCA 507030WF	8120391	500 x 700 x 300	Cabinet, PC, flange ▪ Grey cover with window, 2-point locking, hinges on the short side
ARCA 507030SWF	8120471	500 x 700 x 300	Cabinet, PC, flange ▪ Grey cover with window, swinghandle, hinges on the short side

Accessories

Order Symbol	Code	Dimensions	Description
MPS ARCA 7050	8120738	650 x 450	Mounting plate ▪ Galvanized steel, for size 700x500x300
MPP ARCA 7050	8120758	650 x 450	Mounting plate perforated ▪ Galvanized steel, for size 700x500x300
MPX ARCA 7050	8120748	650 x 450	Mounting plate ▪ Pertinax, for size 700x500x300
DRS ARCA 507030	8120790		DIN rail frame set ▪ 3 rows x 32 modules, for size 500x700x300
PMK ARCA 70	8120843		Pole mounting kit ▪ For sizes 500x700x300

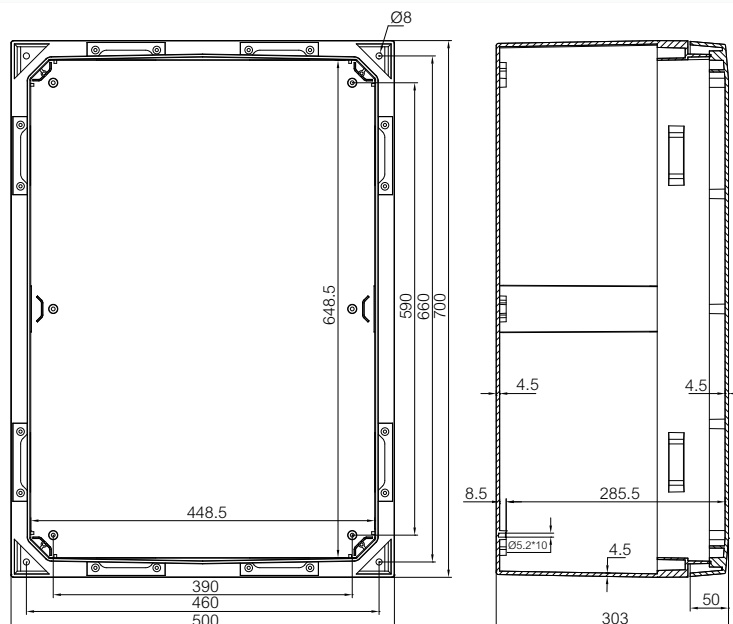



ARCA IEC ARCA 7050

700 x 500

PC: IP66, IK 10

Including: Cabinet base, door with PUR gasket, mounting plate, screws for mounting plate. 3 mm double bit lock(s) with key. S versions with swinghandle 3-point locking system. F versions with flange opening. Door guide included.

Cabinets

Order Symbol	Code	Dimensions	Description
ARCA 705030	8120017	700 x 500 x 300	Cabinet, PC ▪ Grey cover, 2-point locking, hinges on the long side
ARCA 705030S	8120097	700 x 500 x 300	Cabinet, PC ▪ Grey cover, swinghandle, hinges on the long side
ARCA 705030W	8120137	700 x 500 x 300	Cabinet, PC ▪ Grey cover with window, 2-point locking, hinges on the long side
ARCA 705030SW	8120217	700 x 500 x 300	Cabinet, PC ▪ Grey cover with window, swinghandle, hinges on the long side
ARCA 705030F	8120257	700 x 500 x 300	Cabinet, PC, flange ▪ Grey cover, 2-point locking, hinges on the long side
ARCA 705030SF	8120337	700 x 500 x 300	Cabinet, PC, flange ▪ Grey cover with window, swinghandle, hinges on the long side
ARCA 705030WF	8120377	700 x 500 x 300	Cabinet, PC, flange ▪ Grey cover with window, 2-point locking, hinges on the long side
ARCA 705030SWF	8120457	700 x 500 x 300	Cabinet, PC, flange ▪ Grey cover with window, swinghandle, hinges on the long side

Accessories

Order Symbol	Code	Dimensions	Description
MPS ARCA 7050	8120738	650 x 450	Mounting plate ▪ Galvanized steel, for size 700x500x300
MPP ARCA 7050	8120758	650 x 450	Mounting plate perforated ▪ Galvanized steel, for size 700x500x300
MPX ARCA 7050	8120748	650 x 450	Mounting plate ▪ Pertinax, for size 700x500x300
DRS ARCA 705030	8120775		DIN rail frame set ▪ 4 rows x 21 modules, for size 700x500x300
IDS ARCA 7050	8120718		Inner door set ▪ Galvanized steel, for size 700x500x300
PMK ARCA 50	8120845		Pole mounting kit ▪ For size 400x500x210, 700x500x300

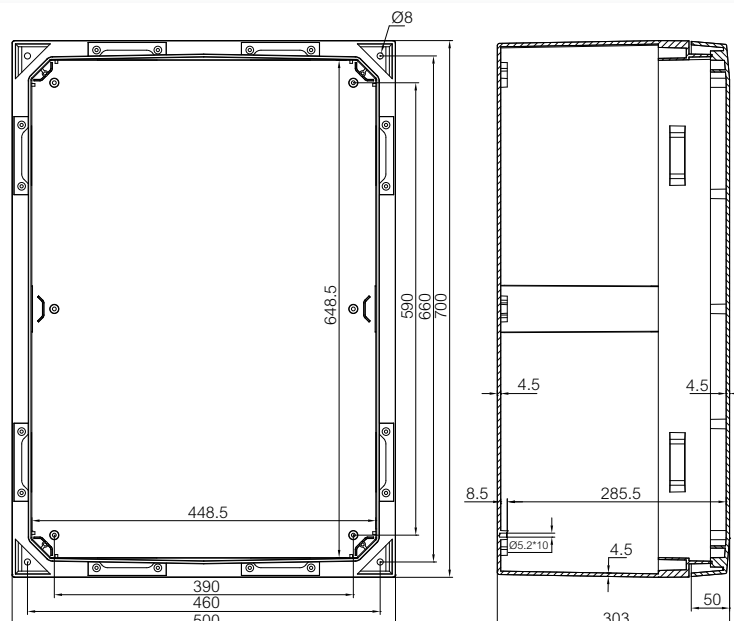

ARCA IEC ARCA 6080

600 x 800

PC: IP66, IK 10



Including: Cabinet base, door with PUR gasket, mounting plate, screws for mounting plate. 3 mm double bit lock(s) with key. S versions with swinghandle 3-point locking system. F versions with flange opening. Door guide included.

Cabinets

Order Symbol	Code	Dimensions	Description
ARCA 608030	8120029	600 x 800 x 300	Cabinet, PC ▪ Grey cover, 2-point locking, hinges on the short side
ARCA 608030S	8120109	600 x 800 x 300	Cabinet, PC ▪ Grey cover, swinghandle, hinges on the short side
ARCA 608030W	8120149	600 x 800 x 300	Cabinet, PC ▪ Grey cover with window, 2-point locking, hinges on the short side
ARCA 608030SW	8120229	600 x 800 x 300	Cabinet, PC ▪ Grey cover with window, swinghandle, hinges on the short side
ARCA 608030SWF	8120469	600 x 800 x 300	Cabinet, PC, flange ▪ Grey cover with window, swinghandle, hinges on the short side
ARCA 608030WF	8120389	600 x 800 x 300	Cabinet, PC, flange ▪ Grey cover with window, 2-point locking, hinges on the short side
ARCA 608030SF	8120349	600 x 800 x 300	Cabinet, PC, flange ▪ Grey cover with window, swinghandle, hinges on the short side
ARCA 608030F	8120269	600 x 800 x 300	Cabinet, PC, flange ▪ Grey cover, 2-point locking, hinges on the short side

Accessories

Order Symbol	Code	Dimensions	Description
MPP ARCA 8060	8120759	750 x 550	Mounting plate perforated ▪ Galvanized steel, for size 800x600x300
MPS ARCA 8060	8120739	750 x 550	Mounting plate ▪ Galvanized steel, for size 800x600x300
MPX ARCA 8060	8120749	750 x 550	Mounting plate ▪ Pertinax, for size 800x600x300
DRS ARCA 608030	8120800		DIN rail frame set ▪ 3 rows x 37 modules, for size 600x800x300
PMK ARCA 80	8120844		Pole mounting kit ▪ For sizes 600x800x300

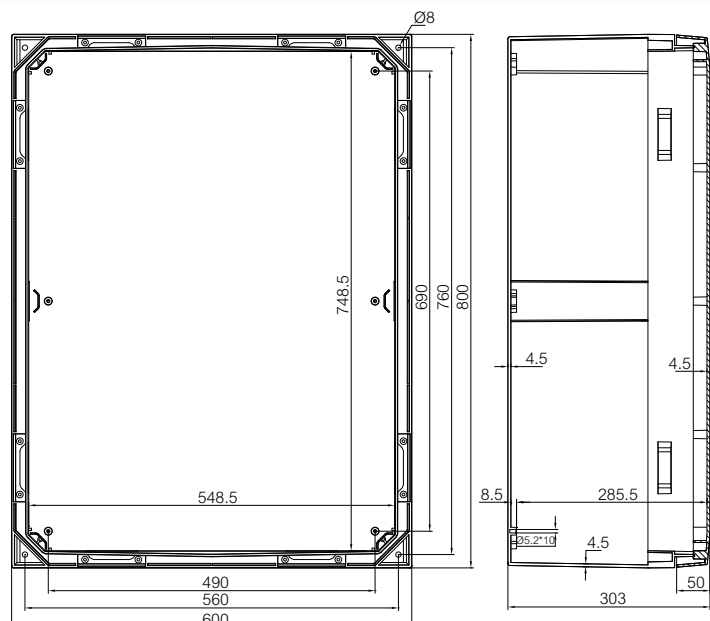



ARCA IEC ARCA 8060

800 x 600

PC: IP66, IK 10

Including: Cabinet base, door with PUR gasket, mounting plate, screws for mounting plate. 3 mm double bit lock(s) with key. S versions with swinghandle 3-point locking system. F versions with flange opening. Door guide included.

Cabinets

Order Symbol	Code	Dimensions	Description
ARCA 806030	8120019	800 x 600 x 300	Cabinet, PC ▪ Grey cover, 2-point locking, hinges on the long side
ARCA 806030S	8120099	800 x 600 x 300	Cabinet, PC ▪ Grey cover, swinghandle, hinges on the long side
ARCA 806030W	8120139	800 x 600 x 300	Cabinet, PC ▪ Grey cover with window, 2-point locking, hinges on the long side
ARCA 806030SW	8120219	800 x 600 x 300	Cabinet, PC ▪ Grey cover with window, swinghandle, hinges on the long side
ARCA 806030F	8120259	800 x 600 x 300	Cabinet, PC, flange ▪ Grey cover, 2-point locking, hinges on the long side
ARCA 806030SF	8120339	800 x 600 x 300	Cabinet, PC, flange ▪ Grey cover with window, swinghandle, hinges on the long side
ARCA 806030WF	8120379	800 x 600 x 300	Cabinet, PC, flange ▪ Grey cover with window, 2-point locking, hinges on the long side
ARCA 806030SWF	8120459	800 x 600 x 300	Cabinet, PC, flange ▪ Grey cover with window, swinghandle, hinges on the long side

Accessories

Order Symbol	Code	Dimensions	Description
MPS ARCA 8060	8120739	750 x 550	Mounting plate ▪ Galvanized steel, for size 800x600x300
MPX ARCA 8060	8120749	750 x 550	Mounting plate ▪ Pertinax, for size 800x600x300
MPP ARCA 8060	8120759	750 x 550	Mounting plate perforated ▪ Galvanized steel, for size 800x600x300
DRS ARCA 806030	8120777		DIN rail frame set ▪ 4 rows x 26 modules, for size 800x600x300
IDS ARCA 8060	8120719		Inner door set ▪ Galvanized steel, for size 800x600x300
PMK ARCA 60	8120846		Pole mounting kit ▪ For size 400x600x210, 800x600x300

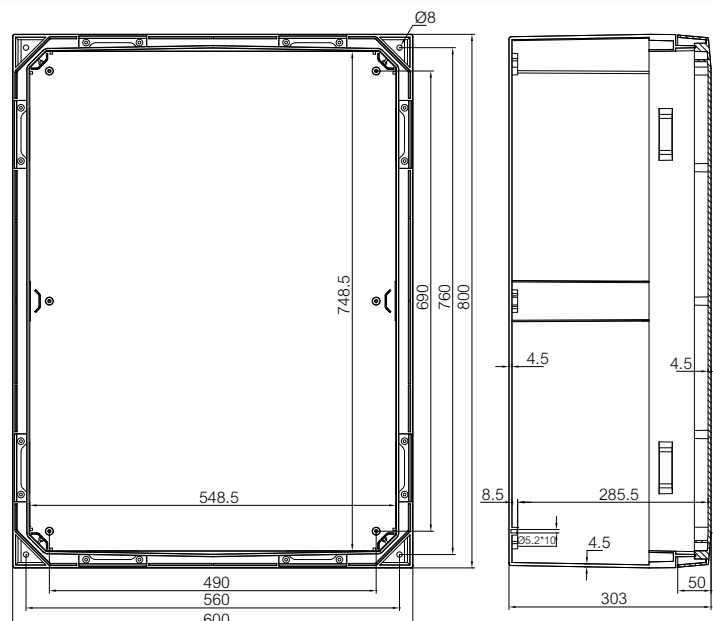

ACCESSORIES

Order symbol	Code	Description
--------------	------	-------------

Mounting plates (Galvanized steel, thickness 2 mm)

MPS ARCA 3020	8120731	Mounting plate ▪ Galvanized steel, for size 300x200x150
MPS ARCA 4030	8120733	Mounting plate ▪ Galvanized steel, for sizes 400x300x150/210
MPS ARCA 5040	8120735	Mounting plate ▪ Galvanized steel, for size 500x400x210
MPS ARCA 6040	8120736	Mounting plate ▪ Galvanized steel, for size 600x400x210
MPS ARCA 7050	8120738	Mounting plate ▪ Galvanized steel, for size 700x500x300
MPS ARCA 8060	8120739	Mounting plate ▪ Galvanized steel, for size 800x600x300



Mounting plates (Perforated galvanized steel, thickness 2 mm)

MPP ARCA 3020	8120751	Mounting plate perforated ▪ Galvanized steel, for size 300x200x150
MPP ARCA 4030	8120753	Mounting plate perforated ▪ Galvanized steel, for sizes 400x300x150/210
MPP ARCA 5040	8120755	Mounting plate perforated ▪ Galvanized steel, for size 500x400x210
MPP ARCA 6040	8120756	Mounting plate perforated ▪ Galvanized steel, for size 600x400x210
MPP ARCA 7050	8120758	Mounting plate perforated ▪ Galvanized steel, for size 700x500x300
MPP ARCA 8060	8120759	Mounting plate perforated ▪ Galvanized steel, for size 800x600x300



Mounting plates (Pertinax, thickness 5 mm)

MPX ARCA 3020	8120741	Mounting plate ▪ Pertinax, for size 300x200x150
MPX ARCA 4030	8120743	Mounting plate ▪ Pertinax, for sizes 400x300x150/210
MPX ARCA 5040	8120745	Mounting plate ▪ Pertinax, for size 500x400x210
MPX ARCA 6040	8120746	Mounting plate ▪ Pertinax, for size 600x400x210
MPX ARCA 7050	8120748	Mounting plate ▪ Pertinax, for size 700x500x300
MPX ARCA 8060	8120749	Mounting plate ▪ Pertinax, for size 800x600x300



DIN rail frame sets

DRS ARCA 203015	8120791	DIN rail frame set ▪ 1 row x 11 modules, for size 200x300x150
DRS ARCA 302015	8120760	DIN rail frame set ▪ 1 row x 5 modules, for size 300x200x150
DRS ARCA 304015	8120793	DIN rail frame set ▪ 1 row x 16 modules, for size 300x400x150
DRS ARCA 304021	8120794	DIN rail frame set ▪ 1 row x 16 modules, for size 300x400x210
DRS ARCA 403015	8120764	DIN rail frame set ▪ 2 rows x 11 modules, for size 400x300x150
DRS ARCA 403021	8120765	DIN rail frame set ▪ 2 rows x 11 modules, for size 400x300x210
DRS ARCA 405021	8120796	DIN rail frame set ▪ 2 rows x 22 modules, for size 400x500x210
DRS ARCA 504021	8120769	DIN rail frame set ▪ 3 rows x 16 modules, for size 500x400x210
DRS ARCA 406021	8120797	DIN rail frame set ▪ 2 rows x 27 modules, for size 400x600x210
DRS ARCA 604021	8120770	DIN rail frame set ▪ 3 rows x 16 modules, for size 600x400x210
DRS ARCA 507030	8120790	DIN rail frame set ▪ 3 rows x 32 modules, for size 500x700x300
DRS ARCA 705030	8120775	DIN rail frame set ▪ 4 rows x 21 modules, for size 700x500x300
DRS ARCA 608030	8120800	DIN rail frame set ▪ 3 rows x 37 modules, for size 600x800x300
DRS ARCA 806030	8120777	DIN rail frame set ▪ 4 rows x 26 modules, for size 800x600x300



ACCESSORIES

Order symbol	Code	Description
Inner door sets (Galvanized steel)		
IDS ARCA 3020	8120711	Inner door set ▪ Galvanized steel, for size 300x200x150
IDS ARCA 4030	8120713	Inner door set ▪ Galvanized steel, for sizes 400x300x150/210
IDS ARCA 5040	8120715	Inner door set ▪ Galvanized steel, for size 500x400x210
IDS ARCA 6040	8120716	Inner door set ▪ Galvanized steel, for size 600x400x210
IDS ARCA 7050	8120718	Inner door set ▪ Galvanized steel, for size 700x500x300
IDS ARCA 8060	8120719	Inner door set ▪ Galvanized steel, for size 800x600x300
Support bar kits		
SBK ARCA 20	8120801	Support bar kit ▪ Length 200 mm
SBK ARCA 30	8120802	Support bar kit ▪ Length 300 mm
SBK ARCA 40	8120803	Support bar kit ▪ Length 400 mm
SBK ARCA 50	8120804	Support bar kit ▪ Length 500 mm
SBK ARCA 60	8120805	Support bar kit ▪ Length 600 mm
SBK ARCA 70	8120806	Support bar kit ▪ Length 700 mm
SBK ARCA 80	8120807	Support bar kit ▪ Length 800 mm
Corner adjustment sets		
CBS ARCA 15	8120810	Corner adjustment set ▪ For sizes with depth 150
CBS ARCA 21	8120811	Corner adjustment set ▪ For sizes with depth 210
CBS ARCA 30	8120812	Corner adjustment set ▪ For sizes with depth 300
Coupling flange		
CFS ARCA	8120820	Coupling Flange ▪ For connecting cabinets
Wall mounting lugs set		
WMK ARCA 10	8120830	Wall mounting lugs set ▪ Adds 10 mm between wall and cabinet
WMK ARCA 40	8120831	Wall mounting lugs set ▪ Adds 40 mm between wall and cabinet
Pole mounting kits		
PMK ARCA 20	8120840	Pole mounting kit ▪ For size 300x200x150
PMK ARCA 30	8120841	Pole mounting kit ▪ For sizes 200x300x150, 400x300x150/210
PMK ARCA 40	8120842	Pole mounting kit ▪ For sizes 300x400x150/210, 500x400x210, 600x400x210
PMK ARCA 50	8120843	Pole mounting kit ▪ For sizes 400x500x210, 700x500x300
PMK ARCA 60	8120844	Pole mounting kit ▪ For sizes 400x600x210, 800x600x300
PMK ARCA 70	8120845	Pole mounting kit ▪ For size 500x700x300
PMK ARCA 80	8120846	Pole mounting kit ▪ For size 600x800x300
Padlocking set		
PLS ARCA	8120850	Padlocking set



ACCESSORIES

Order symbol	Code	Description
--------------	------	-------------

Lock inserts

LIS ARCA DB3	8120860	Locking insert Double-bit 3 mm
LIS ARCA S7	8120861	Locking insert Square 7 mm
LIS ARCA S8	8120862	Locking insert Square 8 mm
LIS ARCA T8	8120863	Locking insert Triangular 8 mm
LIS ARCA 1242E	8120865	Locking 1242E system
LIS ARCA V2432E	8120866	Locking V2432E system
LIS ARCA 455E	8120867	Locking 455E system
LIS ARCA 405E	8120868	Locking 405E system

Half cylinder locks for swinghandle

CLI ARCA DB3	8120870	Half cylinder locking Double-bit 3 mm
CLI ARCA S6	8120871	Half cylinder locking Square 6 mm
CLI ARCA S8	8120872	Half cylinder locking Square 8 mm
CLI ARCA T8	8120873	Half cylinder locking Triangular 8 mm
CLI ARCA 1242E	8120875	Half cylinder locking 1242E system
CLI ARCA V2432E	8120876	Half cylinder locking V2432E system
CLI ARCA 455E	8120877	Half cylinder locking 455E system
CLI ARCA 405E	8120878	Half cylinder locking 405E system

Hinge sets

FHS S ARCA	8120891	Hinge set small • For sizes 300x200-600x400
FHS M ARCA	8120892	Hinge set medium • For sizes 700x500-800x600



ARCA technical information

Property	Polycarbonate (PC)
Material	Glass fibre reinforced polycarbonate
Ingress Protection (EN 60529)	IP 66
Impact Resistance (EN 62262)	IK 10 +35 °C/ IK 09 -25 °C
Temperature Range Celsius (continuous)	-40° . . . +80 °C
Fahrenheit	-40° . . . +175 °F
Temperature Range Celsius (short term)	-40° . . . +120 °C
Fahrenheit	-40° . . . +245 °F
Electrical Insulation	Totally insulated ☐
Light Grey Parts Colour	RAL 7035 (Industry grey)
Glow Wire Test (IEC 695-2-1)	960°
Flammability rating (material)	UL 94-5VA
Non-toxicity	Halogen Free (DIN/VDE 0472, Part 815)
UV resistance	UL 508; 720 hours in "Weatherometer"
Gasket	PUR
Chemical Resistance	Good

Confirmity to standards/directives

EN/IEC 62208, EN/IEC 61439-1-4

RoHS directive 2011/65/EU

Low Voltage Directive 2006/95/EC (up to 1500 VCD)

Data subject to change without notice.

FIBOX PRODUCT CATALOGUE

1 DISCLAIMER

The information included in this Product Catalogue ("Catalogue") is intended to be generic and the related illustrations are intended for illustration purposes. Any and all information is being provided for information purposes only and without responsibility, and Fibox Oy Ab or its affiliates makes no representations or warranties, either expressed or implied, as to the accuracy or completeness of the information, usability of a product or fitness of a product for a particular purpose.

Any and all information included in this Catalogue is subject to change without notice. While Fibox Oy Ab and its affiliates has endeavored to ensure the accuracy of the information contained in the Catalogue, it does not accept liability or responsibility for any inaccuracies.

2 SELLER'S TERMS AND CONDITIONS

The following terms and conditions cover all sales of products and rendering of services by Fibox Oy Ab and by any of its affiliates ("Seller") to Customer. These terms and conditions will supersede all previous communications, agreements or contracts, written or verbal, and no understanding, agreement, term, condition or trade custom at variance herewith will be binding on Seller. No waiver, amendment or modification of the terms and conditions hereof will be effective unless in writing and signed by an officer of Seller.

2.1 INTELLECTUAL PROPERTY

All process information, drawings, specifications, instruction manuals, catalogs and other documents furnished by Seller to Customer for the products sold hereunder shall remain the property of Seller, or its affiliates, as the case may be, and are furnished subject to the condition that Customer use the same only for operation, maintenance and repair of the products and that Customer shall not at any time copy, duplicate, disclose or publish such information. The purchase or use of Seller's products by Customer will not be construed to grant Customer any right, license, sublicense, title or interest in or to any of Seller's or its affiliates' patents, trade names, trademarks, trade secrets, copyrights and other proprietary rights and information or other intellectual, proprietary or industrial property pertaining to the Seller or its products or affiliates, all of which are acknowledged by Customer to be the sole and exclusive property of the Seller or its affiliates, as the case may be.

2.2 FIBOX LIMITED WARRANTY

Seller warrants to Customer that all products and services provided hereunder will be in accordance with specifications and substantially free from defects in material and workmanship under normal use and service for a period of 2 years from date of shipment. This warranty will not, however, apply to any product to the extent the same is, after delivery: (a) repaired or altered outside of Seller's or manufacturer's factory; or (b) subject to misuse, neglect, accident or improper storage, installation, assembly, repair or handling; (c) put to other than normal use or service; or (d) used, maintained, installed, assembled, stored, handled or repaired under conditions which exceed the designed capabilities or in a manner which is not in compliance with Seller's recommendations or with applicable laws, regulations or codes. Seller makes no representation or warranty as to the suitability or compatibility of any product or service with Customer's own equipment, materials, components, products or purpose; and Seller will in no event have any responsibility for the design, performance, use, defect or malfunction of Customer's own equipment, materials, components or products. Seller's sole obligation, and Customer's sole remedy, under the foregoing warranty will be the repair or, at Seller's sole option the replacement, of any product which may be determined by Seller to be

defective, provided that Customer shall notify Seller in writing of such defects within the 2 year warranty period set forth above; and, provided further that Customer will ship such products to Seller's office for repair or replacement, if necessary. THIS PARAGRAPH SETS FOR THE EXCLUSIVE REMEDIES FOR CLAIMS BASED ON DEFECT IN OR FAILURE OF PRODUCTS OR SERVICES, WHETHER THE CLAIM IS IN CONTRACT, INDEMNITY, WARRANTY, TORT (INCLUDING SELLER'S NEGLIGENCE), STRICT LIABILITY OR OTHERWISE AND HOWEVER INSTITUTED. THE FOREGOING WARRANTIES ARE THE SOLE AND EXCLUSIVE WARRANTIES BY SELLER TO CUSTOMER, AND ARE MADE IN LIEU OF ALL OTHER WARRANTIES. THERE ARE NO OTHER WARRANTIES, EXPRESS OR IMPLIED, BY OPERATION OF LAW OR OTHERWISE, FOR ANY PRODUCT OR SERVICE SOLD OR FURNISHED HEREUNDER, AND SELLER DISCLAIMS ALL IMPLIED WARRANTIES OF MERCHANTABILITY AND FITNESS FOR A PARTICULAR PURPOSE. ANY CATALOGUE, SAMPLE OR MODEL IS FOR ILLUSTRATIVE PURPOSES ONLY AND SHALL NOT BE DEEMED TO CREATE AN EXPRESS WARRANTY, AND NO AFFIRMATION OR PROMISE OR DESCRIPTION, OR CATALOGUE, SAMPLE OR MODEL SHALL BE DEEMED PART OF THE BASIS OF THE BARGAIN.

2.3 LIMITATION OF LIABILITY

In no event, whether as a result of breach of contract, indemnity, warranty, tort (including Seller's negligence), strict liability or otherwise, shall Seller's liability to Customer for any loss or damage arising out of, or resulting from the products or services furnished hereunder, exceed the price of the specific product or service which gives rise to the claim, and any such liability shall terminate upon the expiration of the warranty specified in Section 2.2 entitled "Warranties." Any such claim of liability must be timely commenced in a court of competent jurisdiction in accordance with the applicable statute of limitations, but in no event later than one year from the termination of the said warranty. IN NO EVENT SELLER, ITS AFFILIATES, OFFICERS, AGENTS OR EMPLOYEES BE LIABLE FOR ANY INCIDENTAL, INDIRECT, SPECIAL OR CONSEQUENTIAL DAMAGES IN CONNECTION WITH OR ARISING FROM THE PRODUCTS OR SERVICES PROVIDED HEREUNDER, INCLUDING (WITHOUT LIMITATION) LOSS OF PROFITS OR REVENUES, INTERRUPTION OF BUSINESS, LOSS OF USE OF THE PRODUCTS OR ANY ASSOCIATED EQUIPMENT, MATERIALS, COMPONENTS OR PRODUCTS, DAMAGE TO ASSOCIATED EQUIPMENT, MATERIALS, COMPONENTS OR PRODUCTS, COST OF SUBSTITUTE PARTS, OR CLAIMS OF CUSTOMER'S CUSTOMERS FOR SUCH DAMAGES. CUSTOMER'S SOLE REMEDY FOR ANY LIABILITY OF SELLER OF ANY KIND IS LIMITED TO THE REPAIR OR REPLACEMENT OF DEFECTIVE PRODUCTS OR SERVICES AS PROVIDED IN THE IMMEDIATELY PRECEDING PARAGRAPH. CUSTOMER'S SOLE RECOURSE FOR DAMAGES IN CONNECTION WITH OR ARISING FROM THE PRODUCTS OR SERVICES PROVIDED HEREUNDER, WHETHER AS A RESULT OF BREACH OF CONTRACT, INDEMNITY, WARRANTY, TORT (INCLUDING SELLER'S NEGLIGENCE), STRICT LIABILITY OR OTHERWISE, SHALL BE AGAINST SELLER, AND CUSTOMER AGREES THAT NEITHER THE MANUFACTURER NOR SELLER'S AFFILIATES, OFFICERS, EMPLOYEES, STOCKHOLDERS OR AGENTS SHALL HAVE ANY LIABILITY THEREFOR.

2.4 FIBOX GENERAL TERMS

The Seller shall deliver the products and render the services to Customer in accordance with Fibox General Terms. However, in case of any discrepancy between Fibox General Terms and the Seller's Terms and Conditions as provided for in this Catalogue, the Seller's Terms and Conditions shall prevail.

Fibox customer service

Fibox Oy Ab

Keilaranta 19, 02150 Espoo, FINLAND
Tel: +358 207 785 700, Fax: +358 207 785 702
E-mail: info@fibox.fi

Fibox AB

Enhagslingan 3, S-187 40 Täby, SWEDEN
Tel: +46 8 792 2670, Fax: +46 8 792 0164
E-mail: info@fibox.se

Fibox A/S

Kuldysen 13, DK-2630 Tåstrup, DENMARK
Tel: +45 4371 8055, Fax: +45 4371 8035
E-mail: fibox@fibox.dk

Fibox Limited

Suite 25, Durham Tees Valley Business Centre,
Primrose Hill Industrial Estate, Orde Wingate Way,
Stockton on Tees, TS19 0GD, ENGLAND
Tel: +44 1642 604 400, Fax: +44 1642 604 600
E-mail: sales@fibox.co.uk

Fibox France Sarl

Neptune II
35 bis, av. Saint Germain des Noyers
F-77400 Saint Thibault des Vignes
Tel: (+33) 1 60 21 17 17, Fax: (+33) 1 60 21 17 18
E-mail service.client@fibox.fr

Fibox GmbH

Rehwinkel 30, D-32457 Porta Westfalica, GERMANY
Tel: +49 (0)5731 86946 0, Fax: +49 (0)5731 86946 50
E-mail: info@fibox.de

Fibox LLC

Office B 21,
54 B Shpalernaya st.
St. Petersburg
191015 Russia
Tel: +7 911-02-02-102

Fibox New Delhi Office

A-26/4, Mohan Co-operative Industrial Estate, Mathura Road, New Delhi
110044, INDIA
Tel: (+91) 11 40528297, 40528298
Fax: (+91) 11 40512481, Mobile: (+91) 9899911574
E-mail: tyronne.cubbins@fibox.co.in

FIBOX Japan Office

Zip# 542-0081 303, Daiwa building, 2-4-19, Minamisenba, Chuo-Ku,
Osaka, JAPAN
Tel: (+81) 6 4963 3752, Fax: (+81) 6 4963 3762
Mobile: (+81) 90 2705 6742
E-mail: m.takeda@fibox.co.jp

Fibox Benelux

Postbus 350, NL-7570 AJ OLDENZAAL, THE NETHERLANDS
Tel: +31 (0) 541 539039, Fax: +31 (0) 541 533399
E-mail: info@fibox.nl

Fibox Schweiz GmbH

Wissenschwändli 6
6314 Unterägeri, SWITZERLAND
Tel: 055 617 20 80, Fax: 055 617 20 89
E-mail: info@fibox.ch

Fibox Sp. z o.o.

ul. Dzięcioła 19, 04-988 Warszawa, POLAND
Tel: +48 22 256 57 99, Fax: +48 22 256 57 90
E-mail: info@fibox.pl

Fibox Inc.

810 Cromwell Park Drive Suite R, Glen Burnie, MD 21061 USA
Tel: +1 410 760 9696, Fax: +1 410 760 8686
E-mail: sales@fiboxusa.com

Fibox Shanghai Ltd

Room 401 - 402 , Building 3,
NO. 188 xinjunhuan Rd,
Pujiang high-tech Park Caohejing
Development Zone,
Shanghai 201114, China
Tel: (+86) 21 6495 9922, Fax: (+86) 21 6495 9667
E-mail: info@fibox.cn

Fibox (Guangzhou) Engineering Plastic Co., Ltd

No.36 Dong-Peng-Da-Dao, Fibox Road
Guangzhou Economic & Technological Development District, 510530
Guangzhou, Guangdong, P.R.CHINA
Tel: +86 20 3206 7660, Fax: +86 20 3206 7661

Fibox Ltd (Korea)

11-25, Songdo-dong
Yeonsu-gu, Incheon,
Republic of Korea
Tel: +82 32 814 6742, Fax: +82 32 814 6077
E-mail: sales@fibox.co.kr

Fibox Ltd (Korea)

Pusan Office, 562-54, Gwai-Bup, Sa-Sang
Pusan, REPUBLIC OF KOREA
Tel: +82 51 317 8500, Fax: +82 51 314 5533

Fibox production

Fibox Oy Ab

Rajasilta 6, FI-33880 Lempäälä, FINLAND
Tel: +358 207 785 700 number, Fax: +358 207 785 801

Fibox Tested Systems Oy

Hovinpelto 2, FI-74700 Kiuruvesi, FINLAND
Tel: +358 207 785 700, Fax: +358 207 785 851

Fibox Sp. z o.o.

ul. Dzięcioła 19, 04-988 Warszawa, POLAND
Tel: +48 22 256 57 99, Fax: +48 22 872 96 98
E-mail: info@fibox.pl

Fibox India Private Limited

Gat no-147, A II & III, Chakan Talegaon Road
Near Rinder Automation, A/p- Mahalunge,
Tal-Khed, Dist- Pune, Maharashtra, India.- 410501
Tel: +91 02135 - 666777, Fax: +91 02135 - 666789
Email- info@fibox.co.in

Fibox Inc.

810 Cromwell Park Drive Suite R, Glen Burnie, MD 21061 USA
Tel: +1 410 760 9696, Fax: +1 410 760 8686
E-mail: sales@fiboxusa.com

Fibox Shanghai Ltd

Room 401 - 402 , Building 3,
NO. 188 xinjunhuan Rd,
Pujiang high-tech Park Caohejing
Development Zone,
Shanghai 201114, China
Tel: (+86) 21 6495 9922, Fax: (+86) 21 6495 9667
E-mail: info@fibox.cn

Fibox Ltd (Korea)

11-25, Songdo-dong
Yeonsu-gu, Incheon,
Republic of Korea
Tel: +82 32 814 6742, Fax: +82 32 814 6077
E-mail: sales@fibox.co.kr

Fibox (Guangzhou) Engineering Plastic Co., Ltd

No.36 Dong-Peng-Da-Dao, Fibox Road
Guangzhou Economic & Technological Development District,
510530 Guangzhou, Guangdong, P.R.CHINA
Tel: +86 20 3206 7660, Fax: +86 20 3206 7661

Fibox GmbH

Rehwinkel 30, D-32457 Porta Westfalica, GERMANY
Tel: +49 (0)5731 86946 0, Fax: +49 (0)5731 86946 50
E-Mail: info@fibox.de

www.fibox.com

Fibox Oy Ab
Keilaranta 19 D
02150 Espoo
Finland

Tel. +358 207 785 700
Fax +358 207 857 702
E-mail: info@fibox.fi

FIBOX Ltd
Suite 25,
Durham Tees Valley Business Centre,
Primrose Hill Industrial Estate,
Orde Wingate Way,
Stockton on Tees,
TS19 0GD
ENGLAND

TEL. (+44) 1642 604 400
Fax (+44) 1642 604 600
E-mail: sales@fibox.co.uk

Code 9637184

