

Section 11: Ergonomic Workplace Equipment

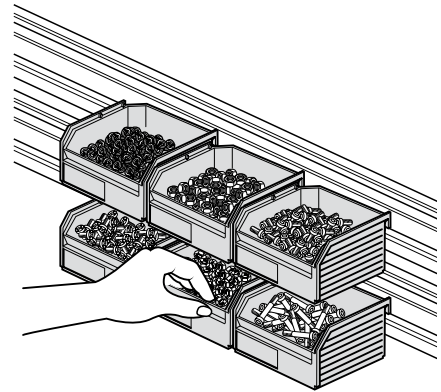

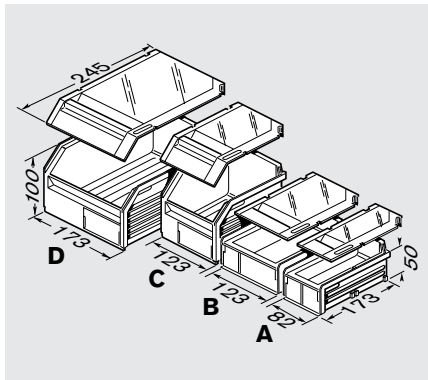





**Plastic Grab Containers** 



**Features:**

- Hold small parts at the workstation to allow easy access
- Can be stacked with other grab trays, grab containers, and grab ledges to optimize space usage
- Ergonomic bottom contours and front edge make it easy to pick up individual parts, even small, flat parts
- Three standard widths available: 82mm, 123mm, and 173mm
- Available in standard and ESD-safe versions

Grab Container HxW (mm)	Volume (cm <sup>3</sup> )	Ref.	Color	ESD
50x82	370	A	Gray	No
50x82	370	A	Black	Yes
50x123	600	B	Gray	No
50x123	600	B	Black	Yes
100x123	1370	C	Gray	No
100x123	1370	C	Black	Yes
100x173	3050	D	Gray	No
100x173	3050	D	Black	Yes

Description	Lot Size	Part Number
<b>A</b> Grab container, 50x82, standard	1	<b>3 842 344 750</b>
<b>A</b> Grab container, 50x82, ESD 	1	<b>3 842 346 280</b>
Cover for <b>A</b> , clear, standard	1	<b>3 842 344 756</b>
Cover for <b>A</b> , black, ESD 	1	<b>3 842 346 286</b>
<b>B</b> Grab container, 50x123, standard	1	<b>3 842 344 751</b>
<b>B</b> Grab container, 50x123, ESD 	1	<b>3 842 346 281</b>
Cover for <b>B</b> , clear, standard	1	<b>3 842 344 757</b>
Cover for <b>B</b> , black, ESD 	1	<b>3 842 346 287</b>
<b>C</b> Grab container, 100x123, standard	1	<b>3 842 344 752</b>
<b>C</b> Grab container, 100x123, ESD 	1	<b>3 842 346 282</b>
Cover for <b>C</b> , clear, standard	1	<b>3 842 344 758</b>
Cover for <b>C</b> , black, ESD 	1	<b>3 842 346 288</b>
<b>D</b> Grab container, 100x173, standard	1	<b>3 842 344 753</b>
<b>D</b> Grab container, 100x173, ESD 	1	<b>3 842 346 283</b>
Cover for <b>D</b> , clear, standard	1	<b>3 842 344 759</b>
Cover for <b>D</b> , black, ESD 	1	<b>3 842 346 289</b>

**Labels and Label Clips**

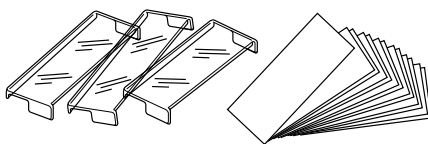

**Features:**

- Transparent label clips attach easily to the front of grab containers
- White labels slide easily into clip
- Allow clear identification of parts and components

**Material:**

- Label clip: clear plastic

Description	Lot Size*	Part Number
Label clips with labels	10	<b>3 842 536 127</b>

\* For smaller quantities, please contact your local distributor.