

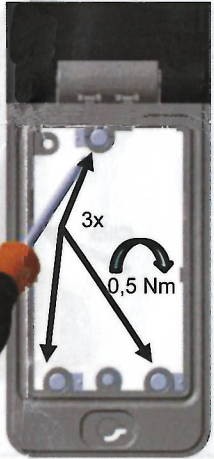

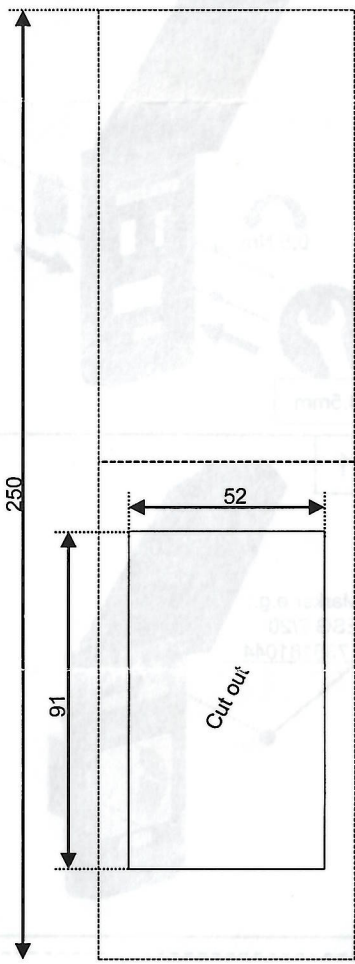



**FrontCom® Vario / IE-FC-XXX**

**Montagehinweis / Mounting information / Référence de montage / Indicaciones de montaje / Informazioni per il montaggio**

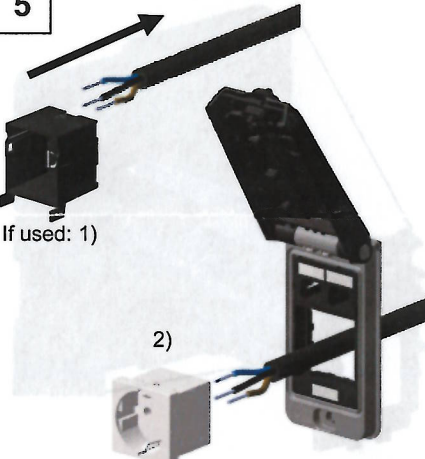
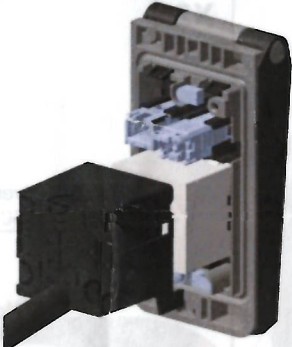
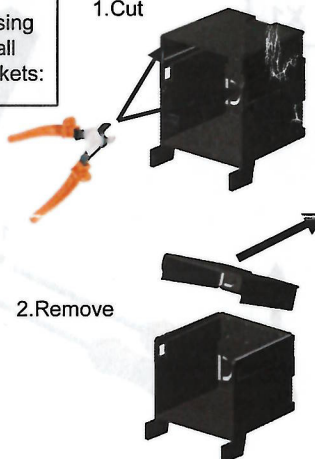
<p><b>1</b></p> 	<p><b>2</b></p>  <p>Screwdriver PZ1: 9008530000</p> <p>3x</p> <p>0,5 Nm</p>	 <p>250</p> <p>91</p> <p>52</p> <p>Cut out</p>
<p><b>3</b></p> 	<p><b>4</b></p>  <p>„Click“</p>	
<p><b>5</b></p>  <p>If used: 1)</p> <p>2)</p>	<p><b>6</b></p>  <p><b>!</b> For power socket the protection cap is recommended, for US power it is mandatory!</p>	
<p><b>6a</b></p> <p>If using small sockets:</p>  <p>1. Cut</p> <p>2. Remove</p>		

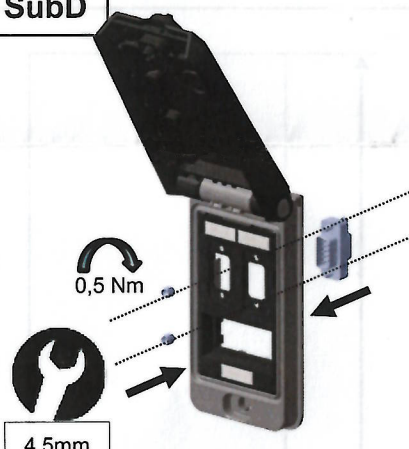
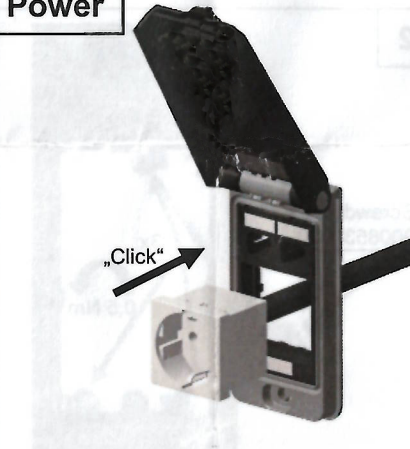
WM-1471650000-00

**Montagehinweis / Mounting information / Référence de montage / Indicaciones de montaje / Informazioni per il montaggio**

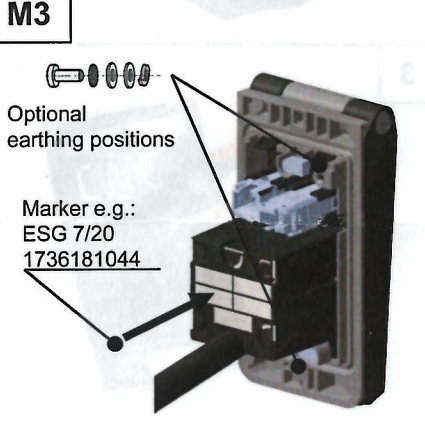
<p><b>SubD</b></p>  <p>0,5 Nm</p> <p>4,5mm</p>	<p><b>Power</b></p>  <p>„Click“</p>	<p><b>Data</b></p>  <p>„Click“</p>
<p><b>M1</b></p>  <p>Marker e.g.: ESG 7/20 1736181044</p>	<p><b>M2</b></p>  <p>Marker e.g.: SM 27/18 1707270000</p>	<p><b>M3</b></p>  <p>Optional earthing positions</p> <p>Marker e.g.: ESG 7/20 1736181044</p>

**Demontage / Dismounting / Démonteur / Desmontar / Smontare**

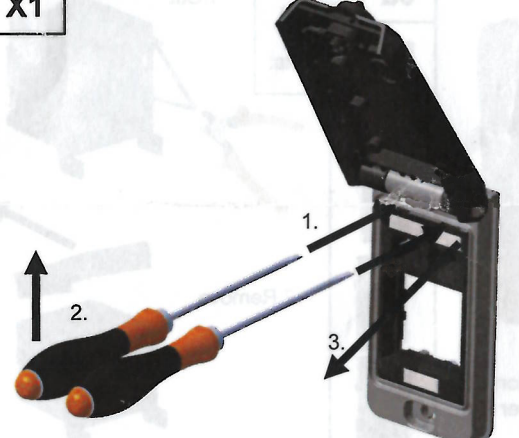
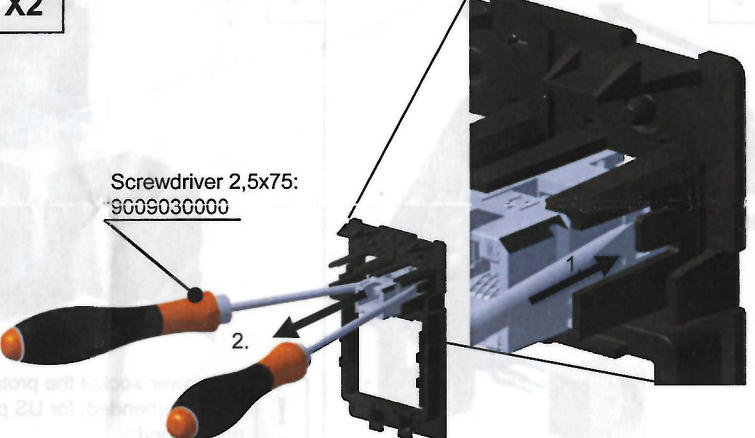
<p><b>X1</b></p>  <p>1.</p> <p>2.</p> <p>3.</p>	<p><b>X2</b></p>  <p>Screwdriver 2,5x75: 9009030000</p> <p>2.</p>
--	---

WM-1471650000-00