

## Grid Plus Modular Switch System

1:6

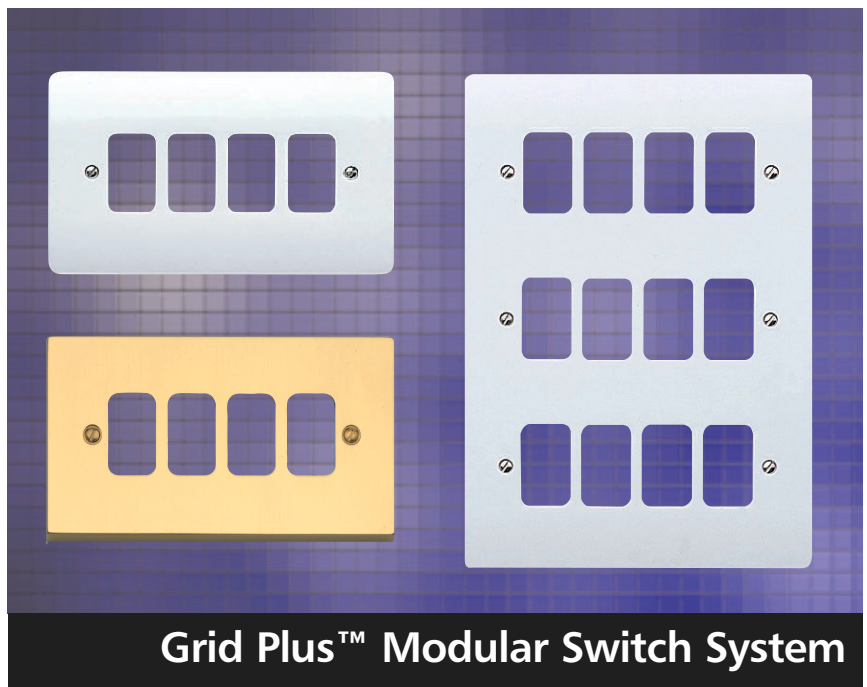

**PRODUCT RANGE**  
For full product range, please refer to tables on pages 2:6, 3.6 and listing on page 4:6

### Description

Grid Plus is a comprehensive modular switching and monitoring system ideal for a variety of applications within the commercial, public and domestic sectors.

Grid Plus cover plates have the advantageous design features of the Logic Plus range and the interchangeable modules also feature many of the wiring and installation benefits common to the Logic Plus range.

The system is extremely easy to assemble (see illustration) and modules can be individually changed without re-wiring of complete assembly by removal of frontplate and simply clipping in or out as required. For further installation details see 'Installation' overleaf.

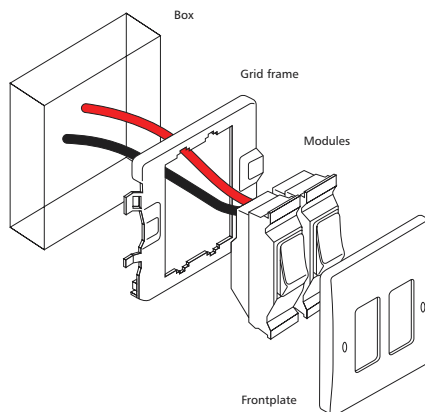

### Universal Socket

The Universal Socket does not incorporate an earth contact. Therefore appliances needing earth connection, (class 1 equipment), must NOT be used with the socket.

The socket is intended for use with BS,VSA & CEE standard plugs.

### Standards and approvals

#### Switch modules

BS 3676: Part 1: 1989

#### Indicator units

BS 5733: 1995

#### Dimmer switches

Dimmers comply with IEC 669-2-1, BSEN 50082-1

#### Accessory modules

Single non-isolated, TV/FM socket outlet, BS 3041: Part 2: 1977

### Features

- Grid modules clip fit to frame without special tools
- Modules can be removed/replaced when grid frame is fixed in position
- Grid Plus styling matches Logic Plus plate switch range
- All products are 100% tested before delivery
- Options of neon/filament indicators label in rocker or printed rockers
- Wide variety of switch modules rated at 10 or 20 amps
- Single or double dimmer modules available
- Vast range of grid plates and modules from one source
- High quality passivated grid frame
- Grid frame earth terminal has 16mm<sup>2</sup> cable capacity
- Backed out and captive terminal screws
- Plated grid frame prevents corrosion
- Up to 12 gang Logic Plus grid frontplates and up to 24 gang in decorative metal finish frontplates
- Top access terminal screws





**Grid Plus**  
Modular Switching System

2:6









**SELECTION CHART**

|   | 1                  | 2                  | 3                  | 4                  | 6                      |
|---|---|---|---|---|---|
|   | <b>COVER PLATES</b>   |   |   |   |   |
| <b>LOGIC PLUS</b>                                   | <b>K3631 WHI</b>  | <b>K3632 WHI</b>  | <b>K3633 WHI</b>  | <b>K3634 WHI</b>  | <b>K3636 WHI</b>  |
| <b>METALCLAD PLUS</b>                               | <b>K3491 ALM</b>  | <b>K3492 ALM</b>  | <b>K3493 ALM</b>  | <b>K3494 ALM</b>  | <b>K3496 ALM</b>  |
| <b>ALBANY PLUS</b>                                  |   |   |   |   |   |
| <b>MCO matt chrome</b>                              | <b>K3431 MCO</b>  | <b>K3432 MCO</b>  | <b>K3433 MCO</b>  | <b>K3434 MCO</b>  | <b>K3436 MCO</b>  |
| <b>SAB satin brass</b>                              | <b>K3431 SAB</b>  | <b>K3432 SAB</b>  | <b>K3433 SAB</b>  | <b>K3434 SAB</b>  | <b>K3436 SAB</b>  |
| <b>CHROMA PLUS</b>                                  | <b>K3431 PCR</b>  | <b>K3432 PCR</b>  | <b>K3433 PCR</b>  | <b>K3434 PCR</b>  | <b>K3436 PCR</b>  |
| <b>GROSVENOR PLUS</b>                               | <b>K4331 POB</b>  | <b>K4332 POB</b>  | <b>K4333 POB*</b><br>*will not take K4500 WHI   | <b>K4334 POB</b>  | <b>K4346 POB</b>  |
| <b>SAVOY PLUS</b>                                   | <b>K5331 PBS</b>  | <b>K5332 PBS</b>  | <b>K5333 PBS</b>  | <b>K5334 PBS</b>  | <b>K5346 PBS</b>  |
| <b>EDGE</b>   | <b>K14331</b>   | <b>K14332</b>   | <b>K14333</b>   | <b>K14334</b>   | <b>K14346</b>   |
| <b>INSIGNIA (non UK)</b>                            | See colour key page 3:6   | See colour key page 3:6   | See colour key page 3:6   | See colour key page 3:6   | See colour key page 3:6   |
|   | <b>BOXES</b>  |   |   |   |   |
| <b>LOGIC PLUS flush</b>                             | <b>891 ALM</b><br>2 x 20mm knockouts<br>Dim: 73 x 73 x 40mm   | <b>891 ALM</b><br>2 x 20mm knockouts<br>Dim: 73 x 73 x 40mm   | <b>892 ALM</b><br>4 x 20, 4 x 25mm knockouts<br>Dim: 73 x 133 x 40mm                                | <b>892 ALM</b><br>4 x 20, 4 x 25mm knockouts<br>Dim: 73 x 133 x 40mm                                  | <b>893 ALM</b><br>4 x 20, 4 x 25mm knockouts<br>Dim: 73 x 133 x 40mm                                      |
|   | <b>821 ALM</b><br>without knockouts<br>Dim: 73 x 73 x 40mm  | <b>821 ALM</b><br>without knockouts<br>Dim: 73 x 73 x 40mm  | <b>822 ALM</b><br>without knockouts<br>Dim: 73 x 133 x 40mm   | <b>822 ALM</b><br>without knockouts<br>Dim: 73 x 133 x 40mm   | <b>823 ALM</b><br>without knockouts<br>Dim: 73 x 133 x 40mm   |
| <b>LOGIC PLUS surface metal</b>                     | <b>K2213 ALM</b><br>5 x 20mm knockouts  | <b>K2213 ALM</b><br>5 x 20mm knockouts  | <b>K2214 ALM</b><br>7 x 20mm knockouts  | <b>K2214 ALM</b><br>7 x 20mm knockouts  |   |
|   | <b>K2211 ALM</b><br>without knockouts   | <b>K2211 ALM</b><br>without knockouts   | <b>K2212 ALM</b><br>without knockouts   | <b>K2212 ALM</b><br>without knockouts   |   |
| <b>LOGIC PLUS surface moulded</b>                   | <b>K2140 WHI</b><br>with knockouts  | <b>K2140 WHI</b><br>with knockouts  | <b>K2142 WHI</b><br>with knockouts  | <b>K2142 WHI</b><br>with knockouts  |   |
| <b>LOGIC PLUS surface pvc</b>                       | <b>K2181 WHI</b><br>with knockouts  | <b>K2181 WHI</b><br>with knockouts  | <b>K2183 WHI</b><br>with knockouts  | <b>K2183 WHI</b><br>with knockouts  |   |
| <b>METALCLAD PLUS &amp; ALBANY PLUS surface</b>     | <b>K8891 ALM</b><br>5 x 20mm knockouts  | <b>K8891 ALM</b><br>5 x 20mm knockouts  | <b>K8892 ALM</b><br>7 x 20mm knockouts  | <b>K8892 ALM</b><br>7 x 20mm knockouts  | <b>K8893 ALM</b><br>4 x 20mm, 4 x 25mm knockouts  |
|   | <b>K8821 ALM</b><br>without knockouts   | <b>K8821 ALM</b><br>without knockouts   | <b>K8822 ALM</b><br>without knockouts   | <b>K8822 ALM</b><br>without knockouts   | <b>K8823 ALM</b><br>without knockouts   |
|   | <b>K8901 ALM</b><br>deep box<br>5 x 20mm knockouts  | <b>K8901 ALM</b><br>deep box<br>5 x 20mm knockouts  | <b>K8902 ALM</b><br>deep box<br>4 x 20mm, 4 x 25mm knockouts  | <b>K8902 ALM</b><br>deep box<br>4 x 20mm, 4 x 25mm knockouts  |   |
| <b>ALBANY PLUS CHROMA PLUS &amp; EDGE flush</b>     | <b>891 ALM</b><br>2 x 20mm knockouts<br>Dim: 73 x 73 x 40mm   | <b>891 ALM</b><br>2 x 20mm knockouts<br>Dim: 73 x 73 x 40mm   | <b>892 ALM</b><br>4 x 20, 4 x 25mm knockouts<br>Dim: 73 x 133 x 40mm                                | <b>892 ALM</b><br>4 x 20, 4 x 25mm knockouts<br>Dim: 73 x 133 x 40mm                                  | <b>893 ALM</b><br>4 x 20, 4 x 25mm knockouts<br>Dim: 73 x 133 x 40mm                                      |
|   | <b>821 ALM</b><br>without knockouts<br>Dim: 73 x 73 x 40mm  | <b>821 ALM</b><br>without knockouts<br>Dim: 73 x 73 x 40mm  | <b>822 ALM</b><br>without knockouts<br>Dim: 73 x 133 x 40mm   | <b>822 ALM</b><br>without knockouts<br>Dim: 73 x 133 x 40mm   | <b>823 ALM</b><br>without knockouts<br>Dim: 73 x 133 x 40mm   |
| <b>GROSVENOR PLUS &amp; SAVOY PLUS flush</b>        | <b>891 ALM</b><br>2 x 20mm knockouts<br>Dim: 73 x 73 x 40mm   | <b>891 ALM</b><br>2 x 20mm knockouts<br>Dim: 73 x 73 x 40mm   | <b>892 ALM</b><br>4 x 20, 4 x 25mm knockouts<br>Dim: 73 x 133 x 40mm                                | <b>892 ALM</b><br>4 x 20, 4 x 25mm knockouts<br>Dim: 73 x 133 x 40mm                                  | <b>893 ALM</b><br>4 x 20, 4 x 25mm knockouts<br>Dim: 73 x 133 x 40mm                                      |
|   | <b>821 ALM</b><br>without knockouts<br>Dim: 73 x 73 x 40mm  | <b>821 ALM</b><br>without knockouts<br>Dim: 73 x 73 x 40mm  | <b>822 ALM</b><br>without knockouts<br>Dim: 73 x 133 x 40mm   | <b>822 ALM</b><br>without knockouts<br>Dim: 73 x 133 x 40mm   | <b>823 ALM</b><br>without knockouts<br>Dim: 73 x 133 x 40mm   |
|   | <b>GRIDS</b>  |   |   |   |   |
| Edge/Insignia cover plates include an integral grid | <b>K3701</b><br> | <b>K3702</b><br> | <b>K3703</b><br> | <b>K3704</b><br> | <b>K3703 X 2</b><br> |



**Grid Plus**  
Modular Switching System

3:6

| <b>SELECTION CHART</b>                              | <b>8</b>               | <b>9</b>               | <b>12</b>              | <b>18</b>    | <b>24</b>              |
|---|---|---|---|---|---|
| <b>LOGIC PLUS</b>                                   | <b>K3638 WHI</b>  |   | <b>K3639 WHI</b>  |   |   |
| <b>METALCLAD PLUS</b>                               | <b>K3498 ALM</b>  | <b>K3499 ALM</b>  | <b>K3502 ALM</b>  | <b>K3508 ALM</b>  | <b>K3514 ALM</b>  |
| <b>ALBANY PLUS</b>                                  |   |   |   |   |   |
| <b>MCO matt chrome</b>                              | <b>K3438 MCO</b>  | <b>K3439 MCO</b>  | <b>K3442 MCO</b>  | <b>K3448 MCO</b>  | <b>K3454 MCO</b>  |
| <b>SAB satin brass</b>                              | <b>K3438 SAB</b>  | <b>K3439 SAB</b>  | <b>K3442 SAB</b>  | <b>K3448 SAB</b>  | <b>K3454 SAB</b>  |
| <b>CHROMA PLUS</b>                                  | <b>K3438 PCR</b>  | <b>K3439 PCR</b>  | <b>K3442 PCR</b>  | <b>K3448 PCR</b>  | <b>K3454 PCR</b>  |
| <b>GROSVENOR PLUS</b>                               | <b>K4348 POB</b>  |   | <b>K4352 POB</b>  |   |   |
| <b>SAVOY PLUS</b>                                   | <b>K5348 PBS</b>  |   | <b>K5352 PBS</b>  |   |   |
| <b>EDGE</b><br><b>INSIGNIA (non UK)</b>             | <b>K14348</b><br>See colour key   | <b>K14349</b><br>See colour key   | <b>K14352</b><br>See colour key   | <b>K14358</b><br>See colour key   | <b>K14354</b><br>See colour key   |
|   |   |   |   |   |   |
| <b>LOGIC PLUS flush</b>                             | <b>893 ALM</b><br>4 x 20, 4 x 25mm knockouts<br>Dim: 73 x 133 x 40mm                                    |   | <b>895 ALM</b><br>5 x 20, 5 x 25mm knockouts<br>Dim: 194 x 133 x 40mm                                   | <b>COLOUR KEY</b><br>All Edge frontplates (Insignia range in non UK markets) are supplied with grid module mounting frame. Add the appropriate colour suffix to the list no. eg K14331 BSS.<br><br><b>BSS</b> Brushed Stainless Steel<br><b>PBR</b> Polished Brass<br><b>SAA</b> Silver Anodised Aluminium<br><b>POC</b> Polished Chrome<br><b>WHI</b> White<br><b>BLA</b> Black Anodised Aluminium<br><b>PBZ</b> Polished Bronze<br><b>ABR</b> Antique Bronze<br><b>BBR</b> Brushed Brass<br><b>GLD</b> Gold Plate |   |
| <b>LOGIC PLUS surface metal</b>                     | <b>823 ALM</b><br>without knockouts<br>Dim: 73 x 133 x 40mm   |   | <b>825 ALM</b><br>without knockouts<br>Dim: 194 x 133 x 40mm  |   |   |
| <b>LOGIC PLUS surface moulded</b>                   |   |   |   |   |   |
| <b>LOGIC PLUS surface pvc</b>                       |   |   |   |   |   |
| <b>METALCLAD PLUS &amp; ALBANY PLUS surface</b>     | <b>K8893 ALM</b><br>4 x 20mm, 4 x 25mm knockouts  | <b>K8895 ALM</b><br>5 x 20mm, 5 x 25mm knockouts  | <b>K8895 ALM</b><br>5 x 20mm, 5 x 25mm knockouts  |   |   |
|   | <b>K8823 ALM</b><br>without knockouts   | <b>K8825 ALM</b><br>without knockouts   | <b>K8825 ALM</b><br>without knockouts   | <b>K8826 ALM</b><br>without knockouts   | <b>K8827 ALM</b><br>without knockouts   |
| <b>ALBANY PLUS CHROMA PLUS &amp; EDGE flush</b>     | <b>893 ALM</b><br>4 x 20, 4 x 25mm knockouts<br>Dim: 73 x 133 x 40mm                                    | <b>895 ALM</b><br>5 x 20, 5 x 25mm knockouts<br>Dim: 194 x 133 x 40mm                                   | <b>895 ALM</b><br>5 x 20, 5 x 25mm knockouts<br>Dim: 194 x 133 x 40mm                                   | <b>898 ALM</b><br>6 x 32mm knockouts  | <b>900 ALM</b><br>6 x 32mm knockouts  |
|   | <b>823 ALM</b><br>without knockouts<br>Dim: 73 x 133 x 40mm   | <b>825 ALM</b><br>without knockouts<br>Dim: 194 x 133 x 40mm  | <b>825 ALM</b><br>without knockouts<br>Dim: 194 x 133 x 40mm  |   |   |
| <b>GROSVENOR PLUS &amp; SAVOY PLUS flush</b>        | <b>893 ALM</b><br>4 x 20, 4 x 25mm knockouts<br>Dim: 73 x 133 x 40mm                                    | <b>895 ALM</b><br>5 x 20, 5 x 25mm knockouts<br>Dim: 194 x 133 x 40mm                                   | <b>895 ALM</b><br>5 x 20, 5 x 25mm knockouts<br>Dim: 194 x 133 x 40mm                                   | <b>898 ALM</b><br>6 x 32mm knockouts  | <b>900 ALM</b><br>6 x 32mm knockouts  |
|   | <b>823 ALM</b><br>without knockouts<br>Dim: 73 x 133 x 40mm   | <b>825 ALM</b><br>without knockouts<br>Dim: 194 x 133 x 40mm  | <b>825 ALM</b><br>without knockouts<br>Dim: 194 x 133 x 40mm  |   |   |
|   |   |   |   |   |   |
| Edge/Insignia cover plates include an integral grid | <b>K3704 X 2</b><br> | <b>K3703 X 3</b><br> | <b>K3704 X 3</b><br> | <b>K3706 X 3</b><br>   | <b>K3706 X 4</b><br> |

**Grid Plus™**

**Modular Switching System**

4:6



| PRODUCT RANGE                         |            | PRODUCT RANGE                   |             | PRODUCT RANGE                                       |   |
|---------------------------------------|------------|---------------------------------|-------------|---|---|
| <b>10A switch modules</b>             |            | 20A DP 1 way red push to break  | K4915 RED   | 1 module blank insert                               | K4880 WHI   |
| 10A SP 1 Way                          | K4881 WHI  | 20A DP 1 way secret key         | K4917 WHI   | 240V buzzer unit                                    | K4000 WHI   |
| 10A SP 2 Way                          | K4882 WHI  | 20A DP 1 way switch/neon        | K4896 NWHI  | 24V buzzer unit                                     | K4001 WHI   |
| 10A retractive                        | K4900 WHI  | 20A SP 1 way switch with window | K4891 WWHI  | 16A 2 pin universal socket                          | K4901 WHI   |
| 10A DP 1 way                          | K4981 WHI  | 20A SP 2 way switch with window | K4892 WWHI  | <b>Architrave frontplates</b>                       |   |
| 10A SP 2 way + "press"                | K4885P WHI | 20A DP 1 way switch with window | K4893 WWHI  | ALBANY PLUS   |   |
| 10A SP 2 way push                     | K4885 WHI  | <b>Indicator units</b>          |             | MCO matt chrome                                     | K3401 MCO   |
| 10A SP 2 way red push                 | K4885 RED  | 240V red neon                   | K4889 RED   | SAB satin brass                                     | K3401 SAB   |
| 10A SP 2 way push + "bell"            | K4885B WHI | 240V amber neon                 | K4889 AMB   | CHROMA PLUS   | K3401 PCR   |
| <b>20A switch modules</b>             |            | 240V red neon                   | K4889 RED   | EDGE  | K14401  |
| 20A SP 1 way                          | K4891 WHI  | 240V green neon                 | K4889 GRN   | INSIGMIA (non UK)                                   | See colour key page 3:6                                     |
| 20A SP 2 way                          | K4892 WHI  | 24V red filament                | K4836 RED   | <b>Architrave boxes</b>                             |   |
| 20A intermediate                      | K4893 WHI  | 24V amber filament              | K4836 AMB   | ALBANY PLUS, CHROMA PLUS & EDGE                     | 3895 ZIC<br>3 x 20mm knockouts<br>(for flush mounting only) |
| 20A SP way & off                      | K4899 WHI  | 24V green filament              | K4836 GRN   | flush   | 3891 ZIC 3892 ZIC<br>1 gang 2 gang<br>Architrave boxes      |
| 20A SP 2 way secret key biased switch | K4918 WHI  | <b>Dimmer switch</b>            |             | <b>Architrave grid</b>                              | K3708   |
| 20A intermediate secret key           | K4894 WHI  | 1 gang 220W/180VA               | K4501 WHILV | Edge/Insignia cover plates include an integral grid |   |
| 20A SP 2 way secret key               | K4898 WHI  | 1 gang 400W/320VA               | K4500 WHILV |   |   |
| 20A DP 1 way                          | K4896 WHI  | <b>Accessory modules</b>        |             |   |   |
| 20A DP 1 way push to make             | K4910 WHI  | Co-ax socket TV/FM 1 module     | K4520 WHI   |   |   |
| 20A DP 1 way push to make             | K4910 RED  | Cord outlet 10mm diameter       | K4886 WHI   |   |   |
| 20A DP 1 way push to break            | K4915 WHI  | 13A fuse unit                   | K4890 WHI   |   |   |

**Multiple dimmer installation load ratings**

To avoid overheating when using more than one dimmer in the same Grid Plus Enclosure it is recommended that the dimmers are preferentially mounted on the bottom row on 6, 8, 9, 12, 18 and 24 gang enclosures, before mounting on any other row(s). Also, each dimmer MUST be de-rated and its load adjusted in accordance with the information provided in Table 3.

The maximum Power/Load figures given in table 3 should not be exceeded, taking due care with different figures for normal GLS tungsten filament lamps compared with Mains Tungsten Halogen Lamps and Low Voltage Transformers. Use of the latter is not recommended.

**Load adjustment table for Grid Plus Dimmers**

| Frontplate Size, Number of Gangs   | 2   | 3   | 4   | 6   | 8   | 9   | 12  | 18   | 24   |
|--|-----|-----|-----|-----|-----|-----|-----|------|------|
| Max Power/Load <u>per Row</u> – Tungsten GLS Lamps – W   | 400 | 480 | 480 | 480 | 480 | 480 | 480 | 720  | 720  |
| Max Power/Load <u>per Row</u> – Mains Tungsten Halogen Lamps or Low Voltage Transformers – W or VA         | 320 | 380 | 380 | 380 | 380 | 380 | 380 | 580  | 580  |
| Max Power/Load for <u>Total Plate</u> – Tungsten GLS Lamps – W   | 400 | 480 | 480 | 740 | 740 | 940 | 940 | 1440 | 1800 |
| Max Power/Load for <u>Total Plate</u> – Mains Tungsten Halogen Lamps or Low Voltage Transformers – W or VA | 320 | 380 | 380 | 600 | 600 | 750 | 750 | 1155 | 1440 |

# Grid Plus™

## Modular Switching System

5:6

### TECHNICAL SPECIFICATION

#### Electrical

##### Switches

Voltage rating:  
250V a.c., 50 Hz

Current rating:  
10 or 20 amps – no derating when used on  
fluorescent or inductive loads.

Load type:  
No restriction

Terminal capacity:  
4 x 1mm<sup>2</sup>, 4 x 1.5mm<sup>2</sup>, 4 x 1mm<sup>2</sup>, 3 x 2.5mm<sup>2</sup>,  
2 x 4mm<sup>2</sup>, 1 x 6mm<sup>2</sup>

##### Indicator Units

Voltage rating:  
24V indicators - min. 21V, max. 36V  
240V indicators - min. 200V, max 250V

Terminal capacity:  
as switches

##### Buzzer Unit

Voltage rating:  
240V  
24V

Terminal capacity:  
as switches

##### Fuse Unit

Voltage rating:  
250V

Current rating:  
13 amps

Terminal capacity:  
2 x 4mm<sup>2</sup>

##### Cord Outlet

Voltage rating:  
250V

Current rating:  
16 amps

Terminal capacity  
Supply: 2 x 4mm<sup>2</sup>  
Load: 1 x 1.5mm<sup>2</sup> multi-strand

##### Dimmers

Voltage rating:  
230V a.c., 50Hz

Load rating:  
For single dimmer installations:  
K4500 min. 40W/VA, max. 400W/320 VA  
K4501 min. 40W/VA, max. 220W/180 VA  
K4510 min. 40VA, max. 400W  
K4511 min. 40VA, max. 220W  
For multiple dimmer installation see Load Adjustment  
table.

Load types:  
K4500, K4501 tungsten filament (GLS) lamps  
Low voltage lighting electronic or wire-wound  
transformers

Soft start:  
Raises from low to control knob setting in 1-3 secs,  
(increases lamp life significantly)

Terminal capacity  
1 x 2.5mm<sup>2</sup> 2 x 1.5mm<sup>2</sup>

##### Universal Socket

Voltage rating  
125/250V

Current rating:  
16 amps

Terminal capacity  
2 x 6mm<sup>2</sup> (stranded)  
3 x 4mm<sup>2</sup> 3 x 2.5mm<sup>2</sup>

### Dimensions (mm)

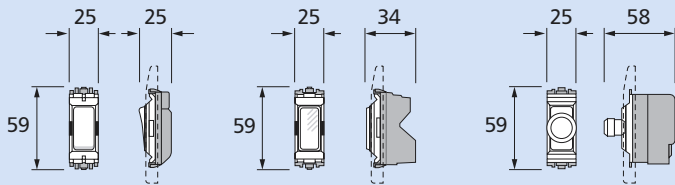

All switch and  
indicator modules

24/240V  
buzzer units

Single dimmer  
module

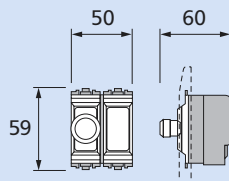

Double dimmer  
module

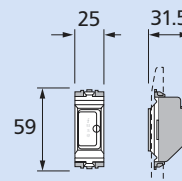

Fuse unit

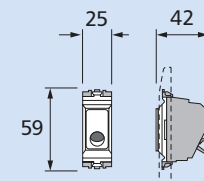

Cord unit

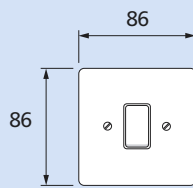

1 gang

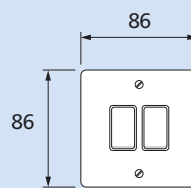

2 gang

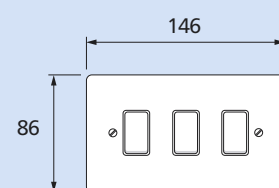

3 gang

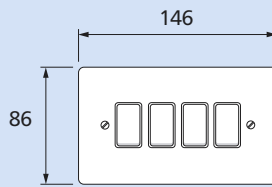

4 gang

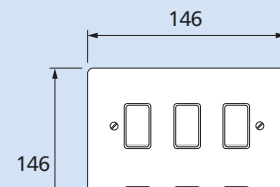

6 gang

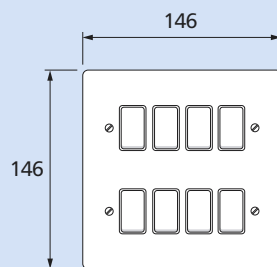

8 gang

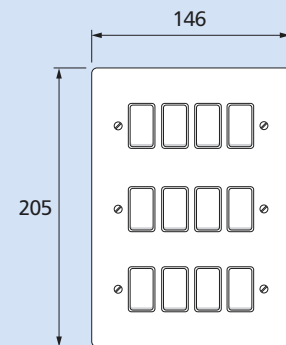

12 gang

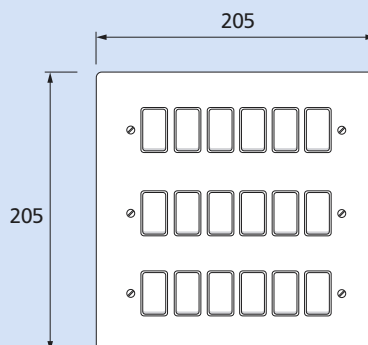

18 gang

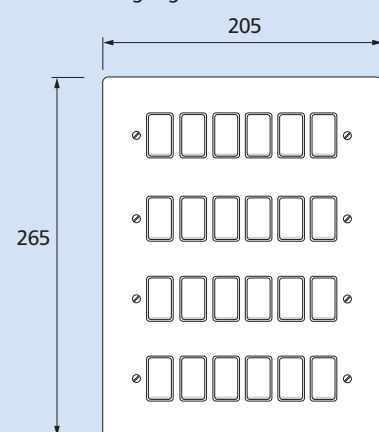

24 gang

# Grid Plus™ Modular Switching System

6:6

## TECHNICAL SPECIFICATION

### Physical (all products)

Operating temperature:  
-5°C to +40°C

IP rating:  
IP4-

Max. installation altitude:  
2000 metres



## Installation

### General

Cut cables to length and make earth connections to grid. Earth: bond Grid Frame to metal mounting box. Grid frames are screwed to back box, modules wired as appropriate and simply clipped into grid frame by hand. No tools are necessary. The front plate is screw fixed to the grid frame to finish the assembly.

To remove or change modules, simply remove front plate. Individual modules fit perfectly into the frontplate in flush fitting installations.

### Grid mounting

An integral design feature automatically ensures that the modules fit perfectly into the frontplate in flush fitting installations.

Some manual adjustment may be required for surface mounted applications.

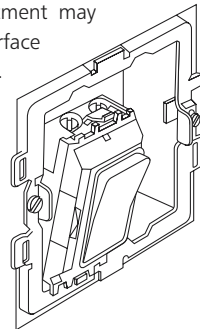

- 1 Locate bottom tab of module in base of grid.
- 2 Module pushes into place at top with a 'click'.
- 3 To remove module, press tab at top and lever forward.

### Dimmers

The two module dimmers can only be fitted into two, or four module wide Grid Mounting Frames, and therefore can only be used with 2, 4, 8 and 12 Gang Frontplates.

To avoid overheating when using more than one dimmer in the same Grid Plus Enclosure it is recommended that the dimmers are preferentially mounted on the bottom row on 6, 8, 9, 12, 18 and 24 Gang Enclosures, before mounting on any other rows and its load adjusted in accordance with the information provided in the Load adjustment table on page 3:4.

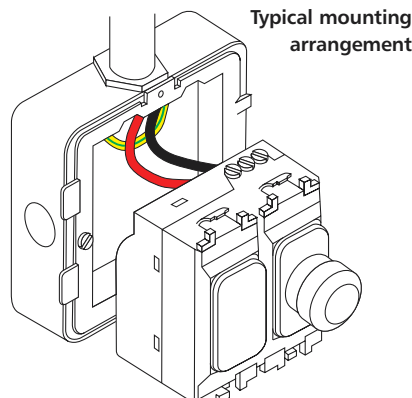

## Dimmer wiring diagram

### One-way switching

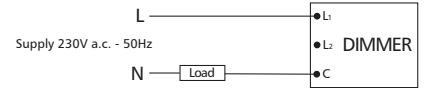

### Two-way switching (only one dimmer can be used)

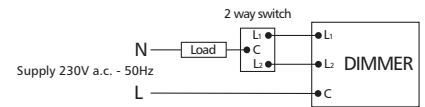

Wires must be connected to the correct Dimmer terminals.  
DO NOT connect earth to Dimmer

## Rocker window labels

The following labels are available for insertion into window rockers.

|                 |              |             |                 |
|-----------------|--------------|-------------|-----------------|
| air conditioner | water heater | dish washer | store           |
| bedroom         | dining area  | kitchen     | lounge          |
| pool            | lights       | bar         | conference room |
| office          | reception    | bell        | push            |
| front           | middle       | bottom      | rear            |
| back            | top          | landing     | hall            |
| porch           | toilets      | ladies      | gents           |
| exterior        |              |             |                 |

The simple installation process is shown below.

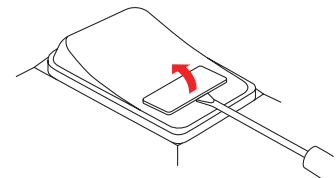

Pry out window on rocker

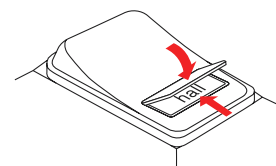

Peel off and insert label. Replace window

Spare labels and windows are available.

## TV/FM socket outlets

The TV outlet must not be mounted in the same enclosure as mains exceeding 50V.

