

Short form catalogue

Fusegear

BS and DIN type HRC-fuse links
OFFN_, OFAF_H, OFAA_GG

Fusegear HRC fuses links

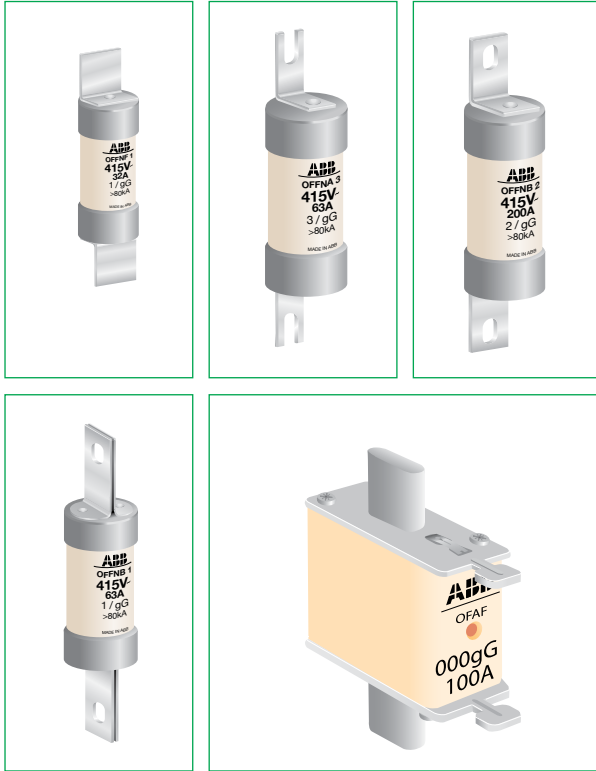

Contents

Fuse range	4
Fuse & switch overview	6
Fuse features	8
BS Type fuses	9
DIN Type fuses	10
Time current curves	14
Cut off currents	16
I ² t charecteristics	18
Dimensions	20

OF

Fuse protection - safe and reliable
2A...1250 A

BS-type HRC fuse links (bolted-type), OFFN_ 2A...800 A, 415 V



BS-size	F1	A1	A2	A3	A4	B1	B2
In [A]	2...32	2...32	6...32	40...63	50...200	50...100 Centred (50 & 63A) Offset (80 & 100A)	125...200
Tag type	Offset	Offset	Offset	Offset	Offset	Offset (80 & 100A)	Offset

DIN-type HRC fuse links, gG OFAF_H_, OFAA_GG_ 2A...1250 A

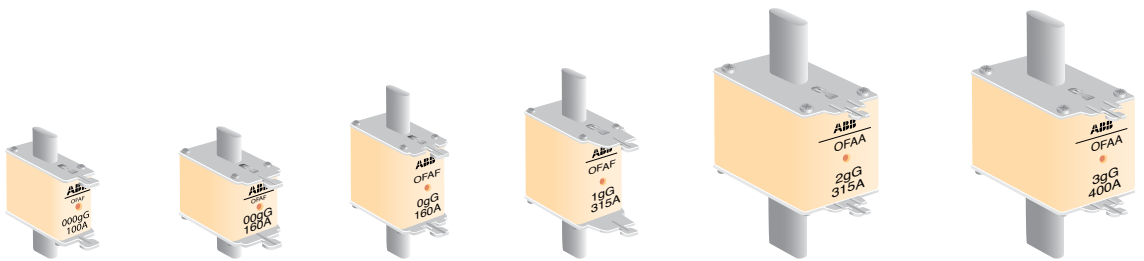

DIN-size	000	00	0	1	2	3
OFAF_H_ / In[A] / 500 V	2...100	125...160	6...250	16...355	25...500	250...800
OFAA_GG_ / In[A] / 690 V	2...63	80...125	6...160	16...250	32...355	250...500



B3
250...315
Centre



B4
400
Centre



C1
400
Centre



C2
500...630
Centre



C3
800
Centre

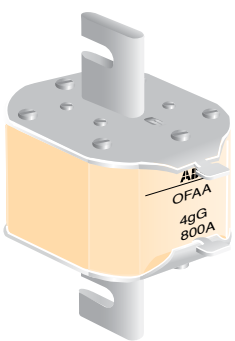

4
400...1250
500...1000

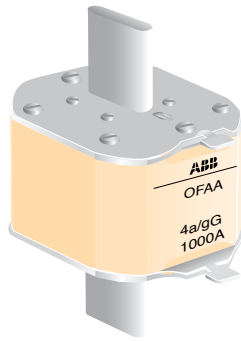







4a
500...1250
500...1000

Fuse and switch overview

2A...1250 A

For optimum performance ABB recommends using ABB fuses along side ABB OS switch fuses

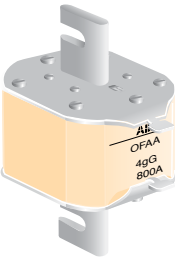
											
Switch Size [A]	16	20	32	32	40	32	63	100	125	160	200
AC23/400V [kW]	7.5	-	15	15	18.5	15	30	-	55	75	75
AC23/415V [kW]	-	7.5	15	15	-	15	30	55	55	75	75
BS Switch Fuses	OS20FB_A1_		OS32FB_A2_		OS32GB_		OS100GB_				
	OS32FB_A1_		-		OS63GB_		OS125GB_				
	-		-		-		OS160GB_				
	-		-		-		OS200GB_				
DIN Switch Fuses	-		OS40FD_		OS32GD_		OS125GD_				
	-		-		OS63GD_		OS160GD_				
BS Fuses		OFFNA1GG2	OFFNA2GG6	OFFNA2GG6	OFFNA4GG50						
		OFFNA1GG4	OFFNA2GG10	OFFNA2GG10	OFFNA4GG63						
		OFFNA1GG6	OFFNA2GG16	OFFNA2GG16	OFFNA4GG80						
		OFFNA1GG10	OFFNA2GG20	OFFNA2GG20	OFFNA4GG100						
		OFFNA1GG16	OFFNA2GG25	OFFNA2GG25	OFFNA4GG125						
		OFFNA1GG20	OFFNA2GG32	OFFNA2GG32	OFFNA4GG160						
		OFFNA1GG25	-	OFFNA3GG40	OFFNA4GG200						
		OFFNA1GG32	-	OFFNA3GG50	-						
	-	-	OFFNA3GG63	-							
DIN 500V Fuses		-	OFAF000H6	OFAF000H6	OFAF000H32						
		-	OFAF000H10	OFAF000H10	OFAF000H35						
		-	OFAF000H16	OFAF000H16	OFAF000H40						
		-	OFAF000H20	OFAF000H20	OFAF000H50						
		-	OFAF000H25	OFAF000H25	OFAF000H63						
		-	OFAF000H32	OFAF000H32	OFAF000H80						
		-	OFAF000H35	OFAF000H35	OFAF000H100						
		-	OFAF000H40	OFAF000H40	OFAF000H125						
		-	-	OFAF000H50	OFAF000H160						
		-	-	OFAF000H63	-						
DIN 690V Fuses		-	OFAA000GG6	OFAA000GG6	OFAA000GG32						
		-	OFAA000GG10	OFAA000GG10	OFAA000GG35						
		-	OFAA000GG16	OFAA000GG16	OFAA000GG40						
		-	OFAA000GG20	OFAA000GG20	OFAA000GG50						
		-	OFAA000GG25	OFAA000GG25	OFAA000GG63						
		-	OFAA000GG32	OFAA000GG32	OFAA000GG80						
		-	OFAA000GG35	OFAA000GG35	OFAA000GG100						
		-	OFAA000GG40	OFAA000GG40	OFAA000GG125						
		-	-	OFAA000GG50	-						
		-	-	OFAA000GG63	-						



200		250		315		400		630		800		1250			
110		140		-		230		355		450		560			
110		145		180		230		355		450		560			
OS200B_				OS315B_				OS630B_				OS1250B_			
OS250B_				OS400B_				OS800B_				-			
-				-				-				-			
-				-				-				-			
OS200D_				OS400D_				OS630D_				OS1250D_			
OS250D_				-				OS800D_				-			
OFFNB1GG50				OFFNB1GG100				OFFNC1GG400				On request			
OFFNB1GG63				OFFNB2GG125				OFFNC2GG500				-			
OFFNB1GG80				OFFNB2GG160				OFFNC2GG630				-			
OFFNB1GG100				OFFNB2GG200				OFFNC3GG800				-			
OFFNB2GG125				OFFNB3GG250				-				-			
OFFNB2GG160				OFFNB3GG315				-				-			
OFFNB2GG200				OFFNB4GG400				-				-			
OFFNB3GG250				-				-				-			
-				-				-				-			
OFAF0H32				OFAF0H100				OFAF3H315				OFAF4H630			
OFAF0H40				OFAF0H125				OFAF3H355				OFAF4H800			
OFAF0H50				OFAF0H160				OFAF3H400				OFAF4H630			
OFAF0H63				OFAF0H200				OFAF3H450				OFAF4H630			
OFAF0H80				OFAF1H200				OFAF3H500				-			
OFAF0H100				OFAF1H250				OFAF3H630				-			
OFAF0H125				OFAF2H315				OFAF3H800				-			
OFAF0H160				OFAF2H400				-				-			
OFAF0H200				-				-				-			
OFAF0H250				-				-				-			
OFAA0GG50				OFAA0GG100				-				-			
OFAA0GG63				OFAA0GG125				OFAA3GG315				OFAA4GG500			
OFAA0GG80				OFAA0GG160				OFAA3GG400				OFAA4GG630			
OFAA0GG100				OFAA1GG200				OFAA3GG425				OFAA4GG800			
OFAA0GG125				OFAA1GG250				OFAA3GG500				OFAA4GG1000			
OFAA0GG160				OFAA2GG315				-				-			
OFAA1GG200				OFAA2GG400				-				-			
OFAA1GG250				-				-				-			
-				-				-				-			
-				-				-				-			

Fuse protection - safe and reliable

Features

- ▶ Total safety for your cables, motors and electronics protection.
- ▶ Wide current ratings for optimal dimensioning of other circuit components.
- ▶ Low let through energy, low cut off characteristics, reduced electro magnetic stress.
- ▶ Energy saving through low power losses.
- ▶ High breaking capacity 80 kA at 415 V (AC).
- ▶ Fault indication on the top of the fuse link for DIN fuses.
- ▶ Conforms to standard IEC 60269.

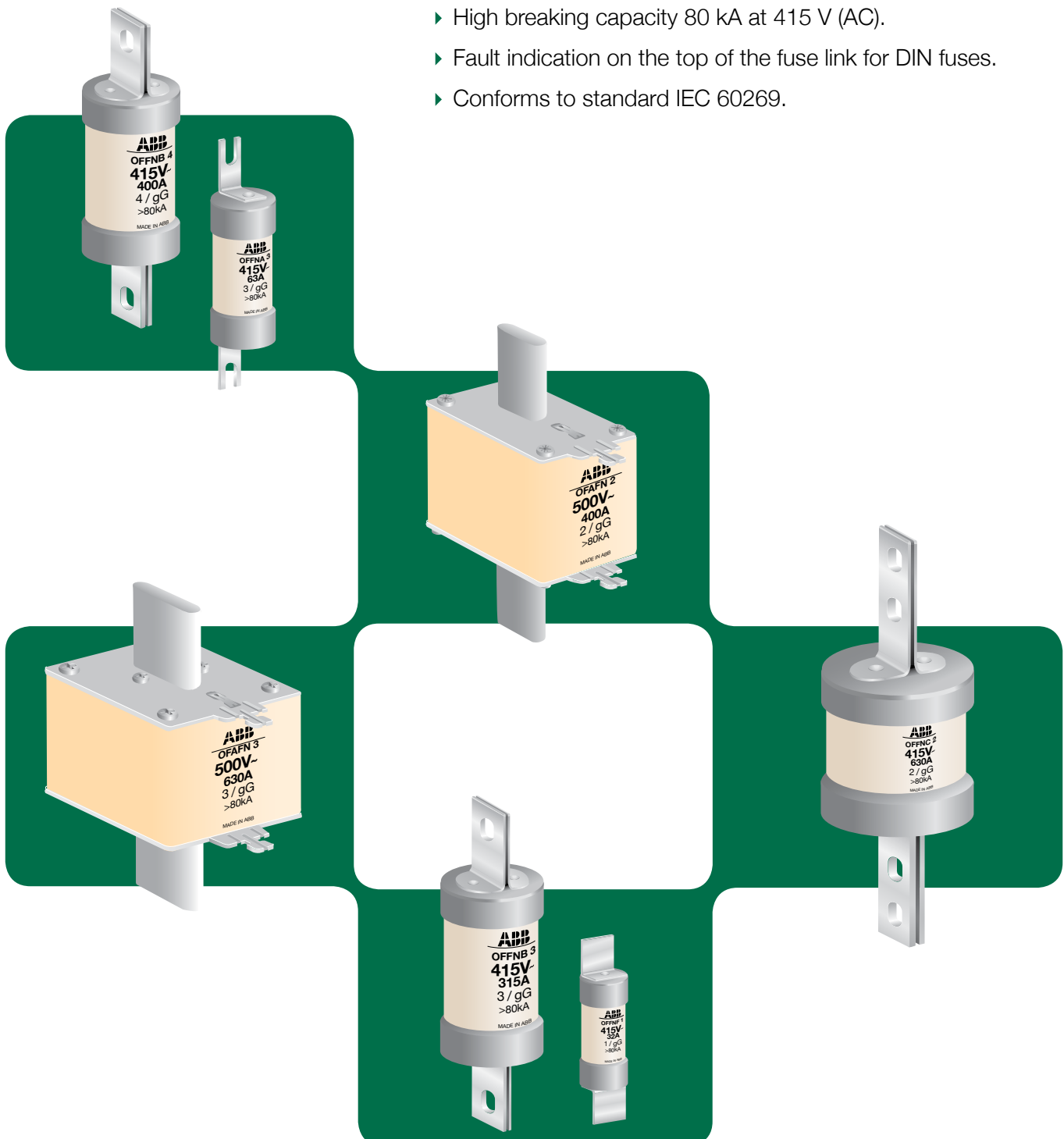

Fusegear HRC fuse links, BS-type

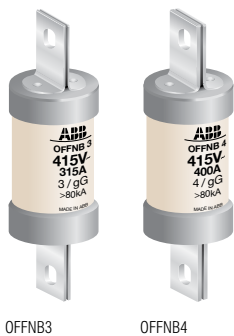
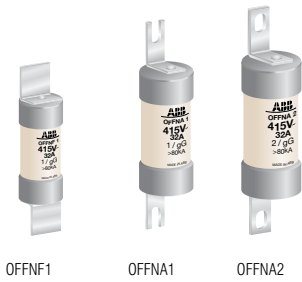

BS-fuse type	In [A]	Ph [W]	Part Number	Product Hierarchy 0002100007 Order Code
Tag type: Offset				
F1	2	0.9	OFFNF1GG2	1SCA107786R1001
	4	1.5	OFFNF1GG4	1SCA107787R1001
	6	1.5	OFFNF1GG6	1SCA107788R1001
	10	1.2	OFFNF1GG10	1SCA107789R1001
	16	1.6	OFFNF1GG16	1SCA107790R1001
	20	1.7	OFFNF1GG20	1SCA107791R1001
	25	2.0	OFFNF1GG25	1SCA107792R1001
	32	2.9	OFFNF1GG32	1SCA107793R1001

Tag type: Offset, two holes fixing 20 (except 50A and 63A B1 fuses)				
A1	2	0.9	OFFNA1GG2	1SCN833065R2012
	4	1.5	OFFNA1GG4	1SCN833066R2012
	6	1.5	OFFNA1GG6	1SCN833067R2012
	10	1.2	OFFNA1GG10	1SCN833068R2012
	16	1.6	OFFNA1GG16	1SCN833069R2012
	20	1.7	OFFNA1GG20	1SCN833061R2012
	25	2.0	OFFNA1GG25	1SCN833070R2012
	32	2.9	OFFNA1GG32	1SCN833062R2012
A2	6	1.5	OFFNA2GG6	1SCA107795R1001
	10	1.2	OFFNA2GG10	1SCA107796R1001
	16	1.6	OFFNA2GG16	1SCA107798R1001
	20	1.7	OFFNA2GG20	1SCA107827R1001
	25	2.0	OFFNA2GG25	1SCA107800R1001
A3	32	2.9	OFFNA2GG32	1SCA107801R1001
	40	3.0	OFFNA3GG40	1SCA107803R1001
	50	3.6	OFFNA3GG50	1SCA107804R1001
A4	63	4.7	OFFNA3GG63	1SCA107805R1001
	50	3.6	OFFNA4GG50	1SCA107806R1001
	63	4.7	OFFNA4GG63	1SCA107807R1001
	80	6.5	OFFNA4GG80	1SCA107808R1001
	100	7.5	OFFNA4GG100	1SCA107809R1001
B1	125	11.5	OFFNA4GG125	1SCA107810R1001
	160	14.5	OFFNA4GG160	1SCN833063R2012
	200	16.2	OFFNA4GG200	1SCN833064R2012
	50	4.8	OFFNB1GG50	1SCA107811R1001
B2	63	5.9	OFFNB1GG63	1SCA107812R1001
	80	6.5	OFFNB1GG80	1SCA107813R1001
	100	7.5	OFFNB1GG100	1SCA107814R1001
B3	125	11.5	OFFNB2GG125	1SCA107816R1001
	160	14.5	OFFNB2GG160	1SCA107817R1001
	200	16.2	OFFNB2GG200	1SCA107818R1001

Tag type: Central, two holes fixing 10				
B3	250	24.0	OFFNB3GG250	1SCA107819R1001
	315	31.0	OFFNB3GG315	1SCA107820R1001
	400	38.0	OFFNB4GG400	1SCA107822R1001

Tag type: Central, four holes fixing				
C1	400	38.0	OFFNC1GG400	1SCA107823R1001
C2	500	48.0	OFFNC2GG500	1SCA107824R1001
	630	54.0	OFFNC2GG630	1SCA107825R1001
C3	800	68.0	OFFNC3GG800	1SCA107826R1001

Fusegear

HRC fuse links, DIN-type, gG

HRC fuse links, gG, universal fuses OFAF_H_, ≤ 500 V

The type code includes one fuse link.
Dual indication.

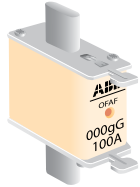

OFAF000H_

000

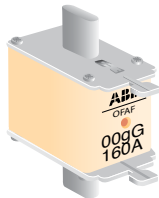

OFAF00H_

00



OFAF0H_

0

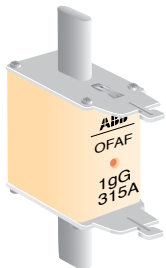

OFAF1H_

1

IEC Size	In [A]	Ph [W]	Part Number	Product Hierarchy 0002000002 Order Code
000	2	3.9	OFAF000H2	1SCA022627R0230
	4	1.5	OFAF000H4	1SCA022627R0310
	6	1.6	OFAF000H6	1SCA022627R0400
	10	1.1	OFAF000H10	1SCA022627R0580
	16	1.8	OFAF000H16	1SCA022627R0660
	20	2.4	OFAF000H20	1SCA022627R0740
	25	2.4	OFAF000H25	1SCA022627R0820
	32	2.7	OFAF000H32	1SCA022627R0910
	35	3	OFAF000H35	1SCA022627R1040
	40	3.4	OFAF000H40	1SCA022627R1120
	50	3.9	OFAF000H50	1SCA022627R1210
	63	4.7	OFAF000H63	1SCA022627R1390
	80	5.7	OFAF000H80	1SCA022627R1470
100	6.7	OFAF000H100	1SCA022627R1550	
00	125	8.4	OFAF00H125	1SCA022627R1630
	160	10.6	OFAF00H160	1SCA022627R1710
0	6	1.8	OFAF0H6	1SCA022627R1800
	10	1.5	OFAF0H10	1SCA022627R1980
	16	2.5	OFAF0H16	1SCA022627R2010
	20	3.5	OFAF0H20	1SCA022627R2100
	25	3.5	OFAF0H25	1SCA022627R2280
	32	3.2	OFAF0H32	1SCA022627R2360
	35	3.5	OFAF0H35	1SCA022627R2440
	40	4.2	OFAF0H40	1SCA022627R2520
	50	5.1	OFAF0H50	1SCA022627R2610
	63	6.2	OFAF0H63	1SCA022627R2790
	80	7.1	OFAF0H80	1SCA022627R2870
	100	8.7	OFAF0H100	1SCA022627R2950
	125	11	OFAF0H125	1SCA022627R3090
	160	11.7	OFAF0H160	1SCA022627R3170
	200	15	OFAF0H200	1SCA022629R5140
250	17.8	OFAF0H250	1SCA022629R5310	
1	16	2.5	OFAF1H16	1SCA022627R3250
	20	3.5	OFAF1H20	1SCA022627R3330
	25	3.3	OFAF1H25	1SCA022627R3410
	32	3.2	OFAF1H32	1SCA022627R3500
	35	3.5	OFAF1H35	1SCA022627R3680
	40	4.2	OFAF1H40	1SCA022627R3760
	50	5.1	OFAF1H50	1SCA022627R3840
	63	6.2	OFAF1H63	1SCA022627R3920
	80	7.1	OFAF1H80	1SCA022627R4060
	100	8.7	OFAF1H100	1SCA022627R4140
	125	11	OFAF1H125	1SCA022627R4220
	160	11.7	OFAF1H160	1SCA022627R4310
	200	14.5	OFAF1H200	1SCA022627R4490
	250	19.7	OFAF1H250	1SCA022627R4650
	315	26	OFAF1H315	1SCA022627R4730
355	26.4	OFAF1H355	1SCA022701R4520	

Fusegear

HRC fuse links, DIN-type, gG

HRC fuse links, gG, universal fuses OFAF_H_, ≤ 500 V

The type code includes one fuse link.

Dual indication on fuse link sizes 2 and 3 up to 630 A.

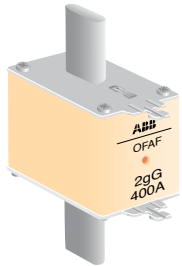

OFAF2H_

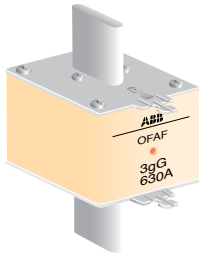

OFAF3H_

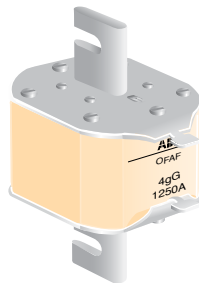

OFAF4H_

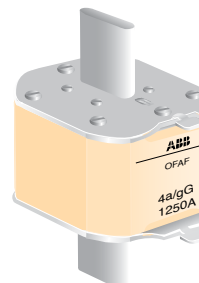

OFAF4AH_

IEC Size	In [A]	Ph [W]	Part Number	Product Hierarchy 0002000002 Order Code
2	25	3.3	OFAF2H25	1SCA115948R1001
	35	3.5	OFAF2H35	1SCA022627R4810
	40	5.1	OFAF2H40	1SCA022627R4900
	50	6	OFAF2H50	1SCA022627R5030
	63	7.1	OFAF2H63	1SCA022627R5110
	80	8.6	OFAF2H80	1SCA022627R5200
	100	10.6	OFAF2H100	1SCA022627R5380
	125	11.9	OFAF2H125	1SCA022627R5460
	160	14	OFAF2H160	1SCA022627R5540
	200	15.4	OFAF2H200	1SCA022627R5620
	250	22.5	OFAF2H250	1SCA022627R5890
	300	24	OFAF2H300	1SCA022627R5970
	315	26.2	OFAF2H315	1SCA022627R6010
	355	27.5	OFAF2H355	1SCA022627R6190
	400	30.2	OFAF2H400	1SCA022627R6270
425	33	OFAF2H425	1SCA022706R3900	
500	44	OFAF2H500	1SCA022701R4610	
3	250	17.9	OFAF3H250	1SCA022627R6350
	300	20	OFAF3H300	1SCA022627R6430
	315	22.4	OFAF3H315	1SCA022627R6510
	355	23.5	OFAF3H355	1SCA022627R6600
	400	30.1	OFAF3H400	1SCA022627R6780
	425	33	OFAF3H425	1SCA022627R6860
	450	36	OFAF3H450	1SCA022627R6940
	500	44	OFAF3H500	1SCA022627R7080
	630	47.5	OFAF3H630	1SCA022627R7160
	800	56.9	OFAF3H800	1SCA022627R7240
4	400	31	OFAF4H400	1SCA022627R7320
	500	35	OFAF4H500	1SCA022627R7410
	630	44	OFAF4H630	1SCA022627R7590
	800	70	OFAF4H800	1SCA022627R7670
	1000	85	OFAF4H1000	1SCA022627R7750
	1250	93	OFAF4H1250	1SCA022627R7830
4a	500	33	OFAF4AH500	1SCA022637R3980
	630	43	OFAF4AH630	1SCA022637R4010
	800	58	OFAF4AH800	1SCA022637R4100
	1000	71	OFAF4AH1000	1SCA022637R4280
	1250	85	OFAF4AH1250	1SCA022637R4360

Fusegear

HRC fuse links, DIN-type, gG

HRC fuse links, gG, universal fuses OFAA_GG_, ≤ 690V

The type code includes one fuse link.
Dual indication.

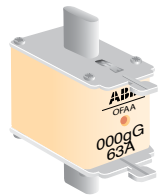

OFAA000GG_



OFAA00GG_



OFAA0GG_

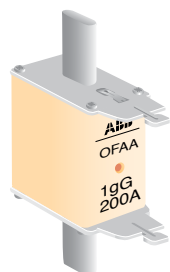

OFAA1GG_

IEC Size	In [A]	Ph [W]	Part Number	Product Hierarchy 0002000002 Order Code
000	2	3.9	OFAA000GG2	1SCA022661R8250
	4	1.5	OFAA000GG4	1SCA022661R8330
	6	1.6	OFAA000GG6	1SCA022661R8410
	10	1.1	OFAA000GG10	1SCA022661R8500
	16	1.8	OFAA000GG16	1SCA022661R8680
	20	2.4	OFAA000GG20	1SCA022661R8760
	25	2.4	OFAA000GG25	1SCA022661R8840
	32	2.7	OFAA000GG32	1SCA022661R8920
	35	3	OFAA000GG35	1SCA022661R9060
	40	3.4	OFAA000GG40	1SCA022661R9140
	50	3.9	OFAA000GG50	1SCA022661R9220
	63	4.7	OFAA000GG63	1SCA022661R9310
	00	80	5.7	OFAA00GG80
100		6.7	OFAA00GG100	1SCA022700R9520
125		8.4	OFAA00GG125	1SCA022724R0610
0	6	1.8	OFAA0GG6	1SCA022703R1290
	10	1.5	OFAA0GG10	1SCA022703R1370
	16	2.5	OFAA0GG16	1SCA022703R1450
	20	3.5	OFAA0GG20	1SCA022703R1530
	25	3.5	OFAA0GG25	1SCA022703R1610
	32	3.2	OFAA0GG32	1SCA022703R1700
	35	3.5	OFAA0GG35	1SCA022703R1880
	40	4.2	OFAA0GG40	1SCA022703R1960
	50	5.1	OFAA0GG50	1SCA022703R2000
	63	6.2	OFAA0GG63	1SCA022703R2180
	80	7.1	OFAA0GG80	1SCA022703R2260
	100	8.7	OFAA0GG100	1SCA022703R2340
	125	11	OFAA0GG125	1SCA022703R2420
160	11.7	OFAA0GG160	1SCA022703R2510	
1	16	2.5	OFAA1GG16	1SCA022703R2690
	20	3.5	OFAA1GG20	1SCA022703R2770
	25	3.3	OFAA1GG25	1SCA022703R2850
	32	3.2	OFAA1GG32	1SCA022703R2930
	35	3.5	OFAA1GG35	1SCA022703R3070
	40	4.2	OFAA1GG40	1SCA022703R3150
	50	5.1	OFAA1GG50	1SCA022700R9610
	63	6.2	OFAA1GG63	1SCA022700R9790
	80	7.1	OFAA1GG80	1SCA022700R9870
	100	8.7	OFAA1GG100	1SCA022700R9950
	125	11	OFAA1GG125	1SCA022701R0020
	160	11.7	OFAA1GG160	1SCA022701R0110
	200	14.5	OFAA1GG200	1SCA022701R0290
250	17.8	OFAA1GG250	1SCA022701R0370	

Fusegear

HRC fuse links, DIN-type, gG

HRC fuse links, gG, universal fuses OFAA_GG_, ≤ 690V

The type code includes one fuse link.
Dual indication on fuse link sizes 2 and 3.

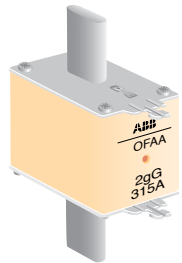

OFAA2GG_

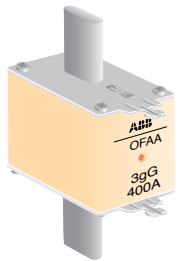

OFAA3GG_

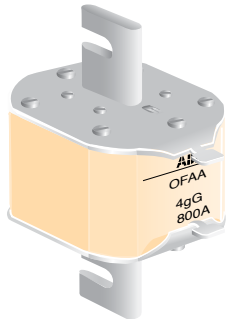

OFAA4GG_

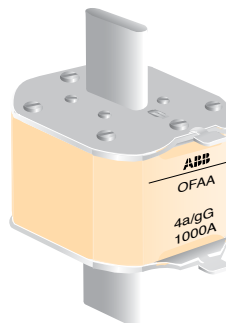

OFAA4AGG_

IEC Size	In [A]	Ph [W]	Part Number	Product Hierarchy 0002000002 Order Code
2	32	3.2	OFAA2GG32	1SCA022703R3230
	35	3.5	OFAA2GG35	1SCA022703R3310
	40	5.1	OFAA2GG40	1SCA022703R3400
	50	6	OFAA2GG50	1SCA022703R3580
	63	7.1	OFAA2GG63	1SCA022703R3660
	80	8.6	OFAA2GG80	1SCA022703R3740
	100	10.6	OFAA2GG100	1SCA022703R3820
	125	11.9	OFAA2GG125	1SCA022701R0450
	160	14	OFAA2GG160	1SCA022701R0530
	200	15.4	OFAA2GG200	1SCA022701R0610
	250	22.5	OFAA2GG250	1SCA022701R0700
	300	24	OFAA2GG300	1SCA022703R4040
	315	26.2	OFAA2GG315	1SCA022701R0880
	355	27	OFAA2GG355	1SCA022701R0960
3	250	17.9	OFAA3GG250	1SCA022703R4120
	300	21	OFAA3GG300	1SCA022703R4210
	315	22.4	OFAA3GG315	1SCA022701R1000
	355	23.5	OFAA3GG355	1SCA022701R1180
	400	30.1	OFAA3GG400	1SCA022701R1260
	425	33	OFAA3GG425	1SCA022706R4030
	500	44	OFAA3GG500	1SCA022701R1340
4	500	35	OFAA4GG500	1SCA022701R1420
	630	44	OFAA4GG630	1SCA022701R1510
	800	70	OFAA4GG800	1SCA022701R1690
	1000	85	OFAA4GG1000	1SCA112679R1001
4a	500	33	OFAA4AGG500	1SCA022660R9770
	630	43	OFAA4AGG630	1SCA022660R9850
	800	58	OFAA4AGG800	1SCA022660R9930
	1000	71	OFAA4AGG1000	1SCA022699R6360

Fusegear

Time current characteristics

BS Type

Time-current characteristics, OFFN_ fuse links, type gG, 415 V

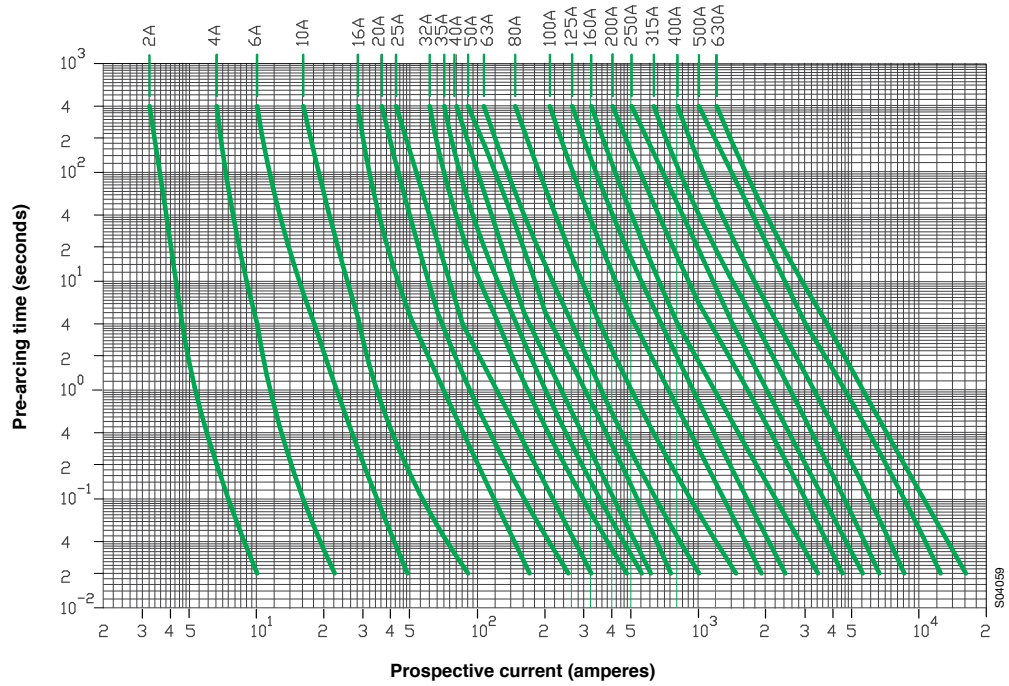

Fusegear

Time current characteristics

DIN Type

Time-current characteristics, 500 V, gG- fuse links OFAF_H_, sizes 000...4/4a

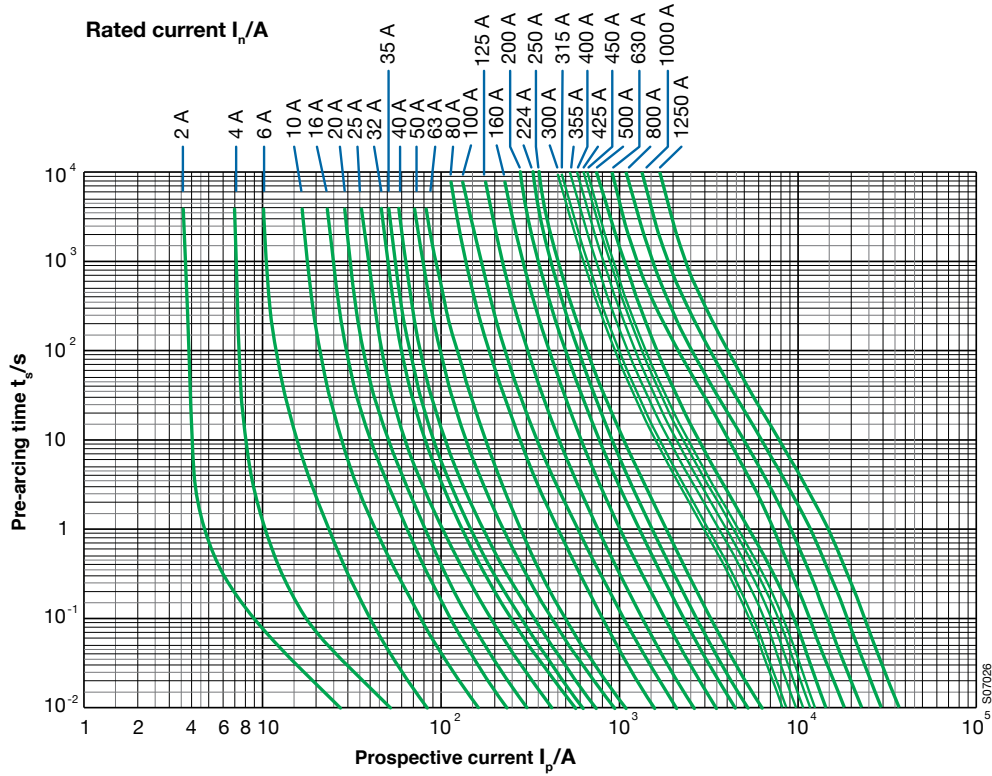

Time-current characteristics, 690 V, gG- fuse links OFAA_GG_ series sizes 000...4a

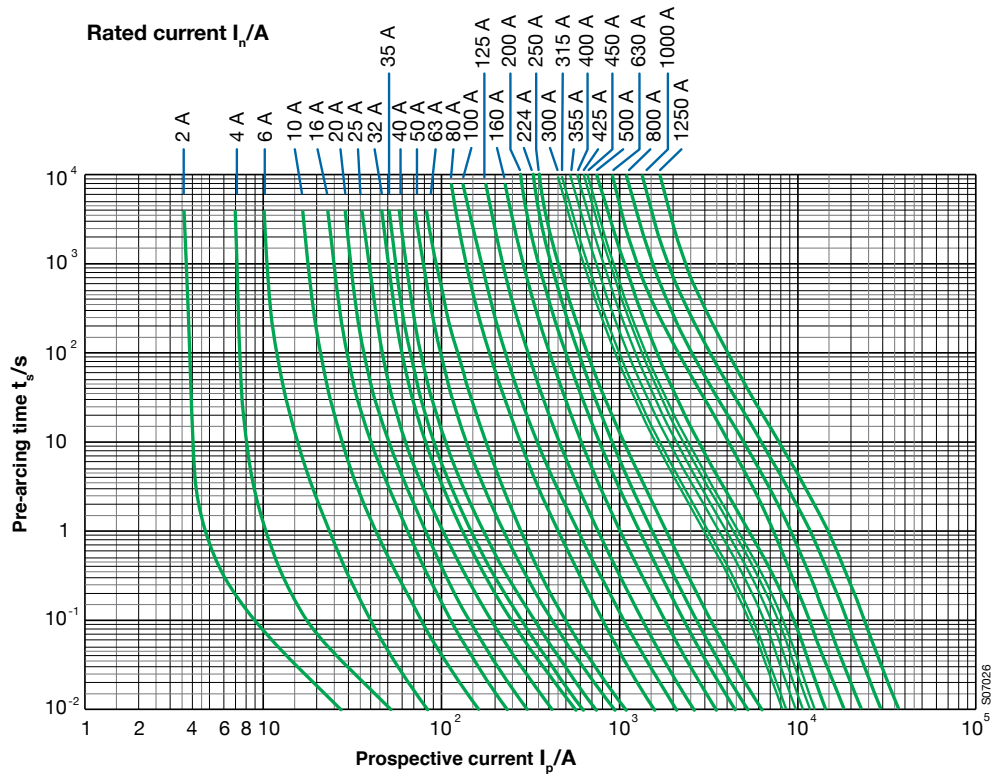

Fusegear

Cut off current characteristics

BS Type

Current limitation, type OFFN_ type gG, 415 V

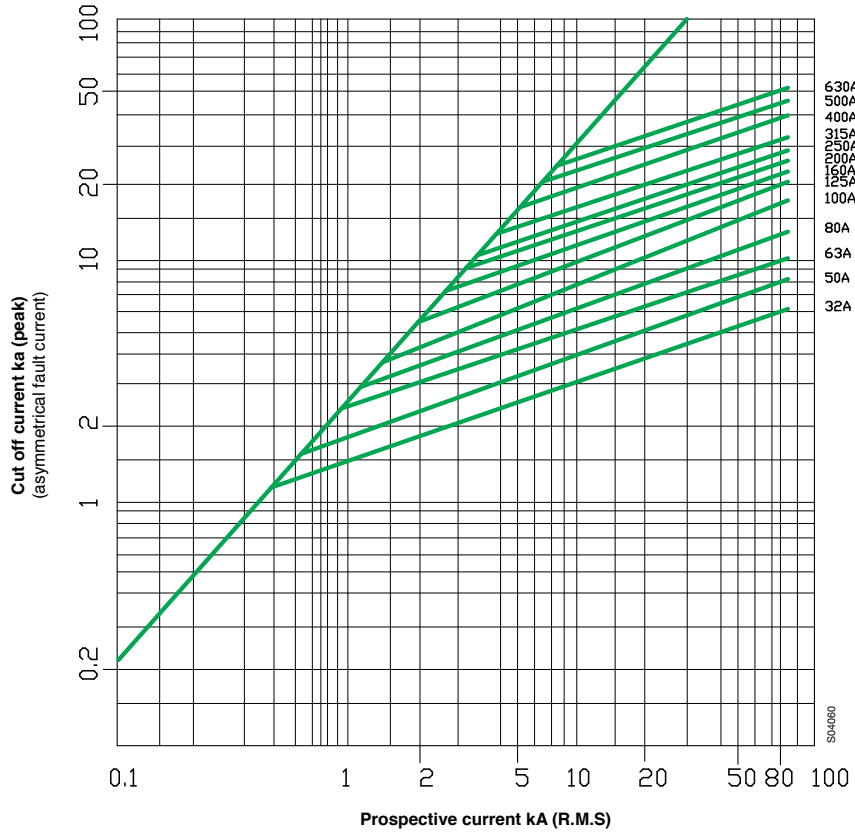

Fusegear

Cut off current characteristics

DIN Type

Current limitation, 500 V, gG- fuse links OFAF_H_, sizes 000...4/4a

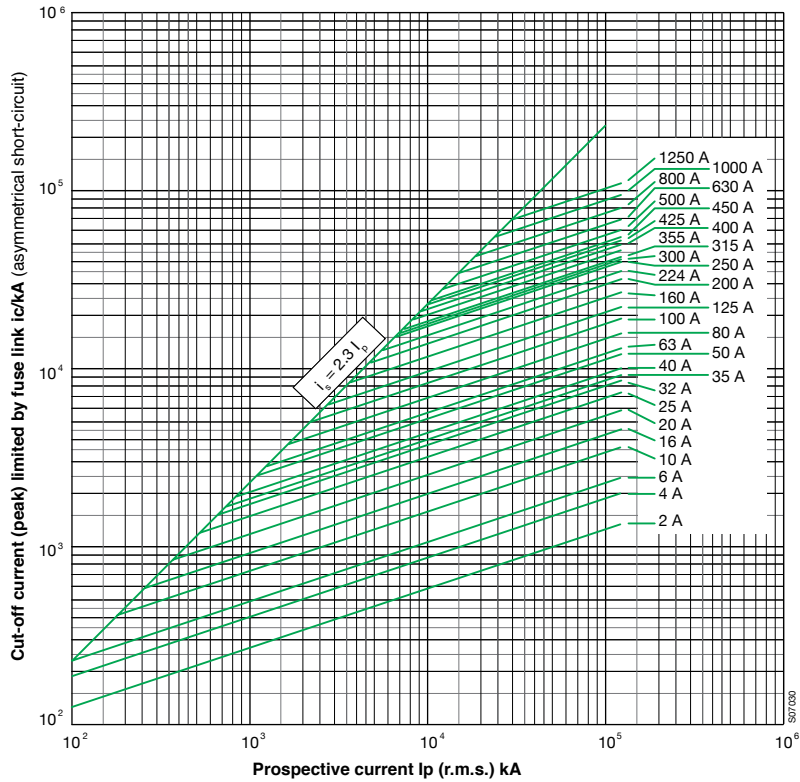

Current limitation, 690 V, gG- fuse links OFAA_GG_, sizes 000...4/4a

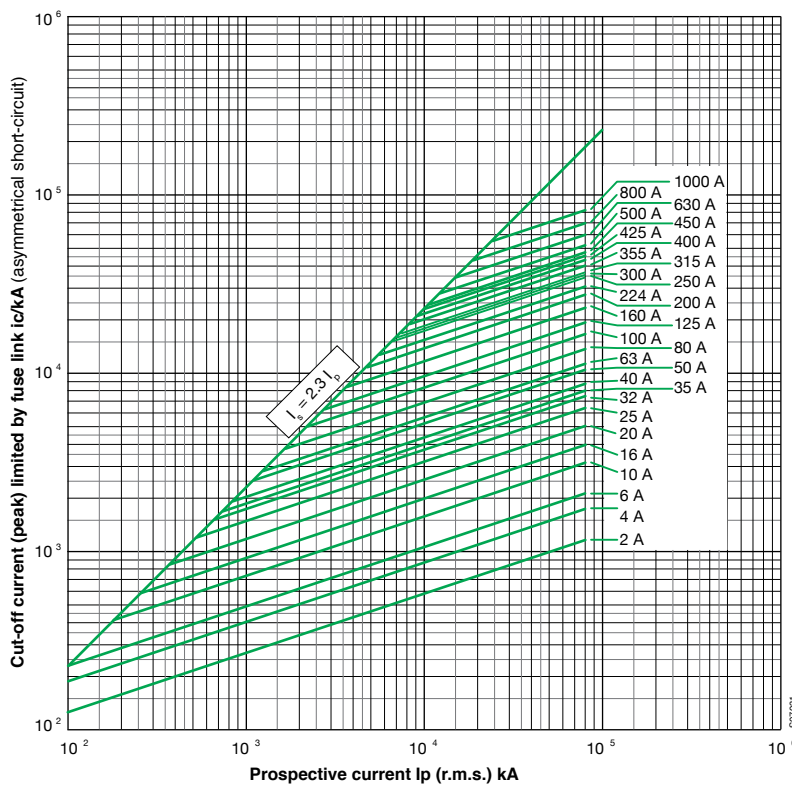

Fusegear

I²t characteristics

BS Type

I²t -values, OFFN_fuse links, type gG, 415 V
 - with prospective current > 80 kA at 415 V

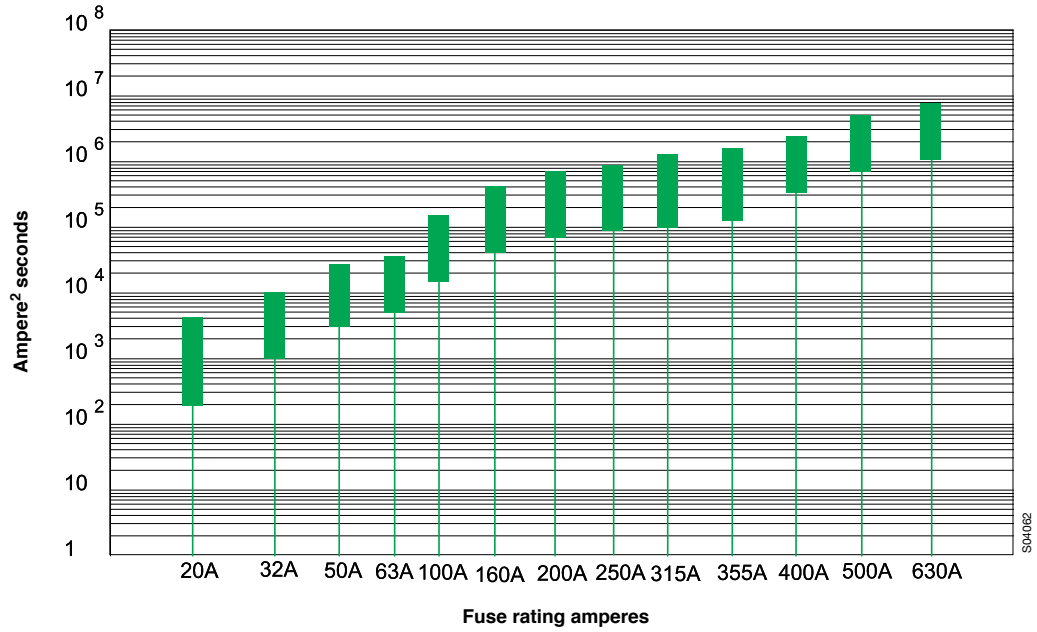

DIN Type

I²t characteristics, 500 V, gG- fuse links OFAF_H_, sizes 000...4/4a

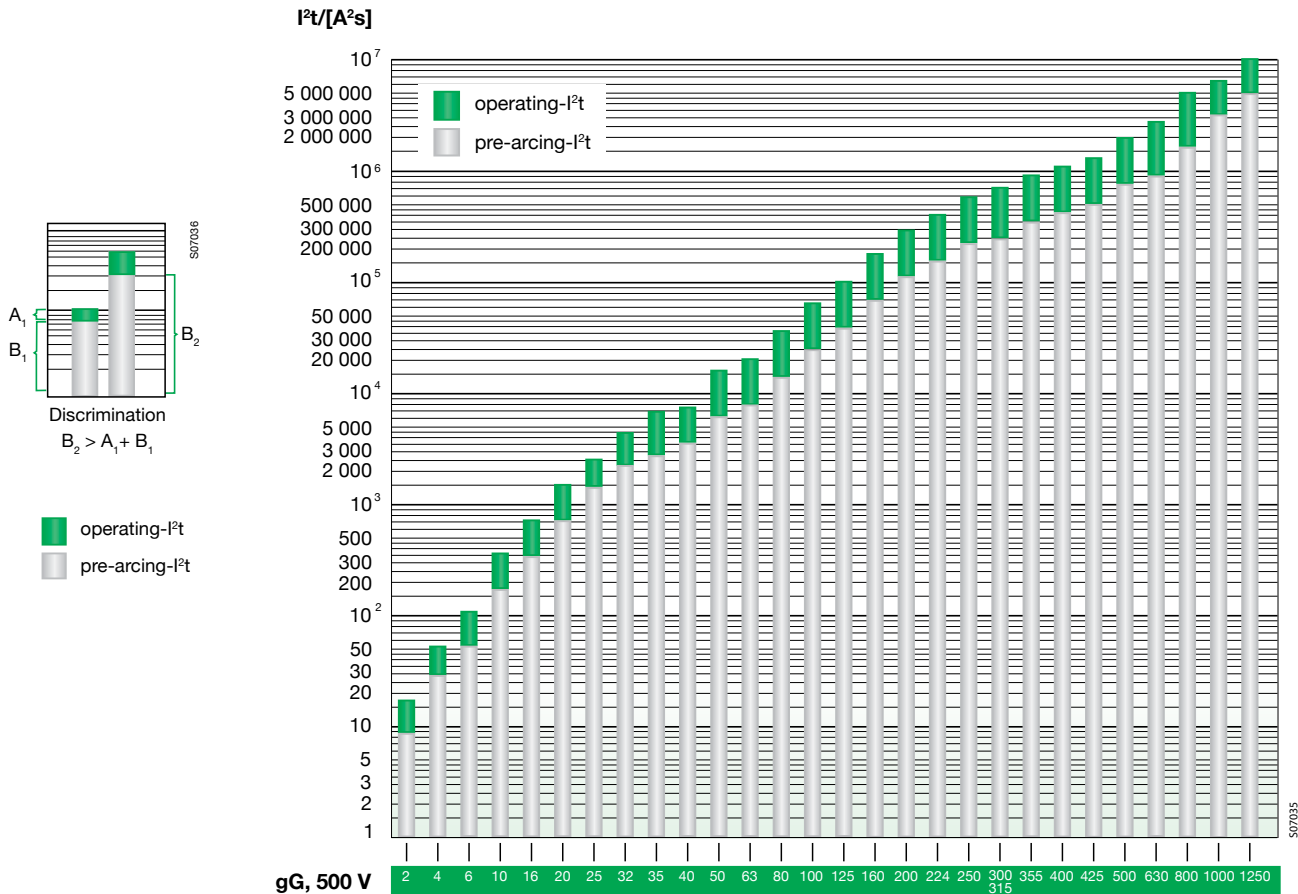

Fusegear

I²t characteristics

DIN Type

I²t characteristics, 690 V, gG- fuse links OFAA_GG_, sizes 000...5

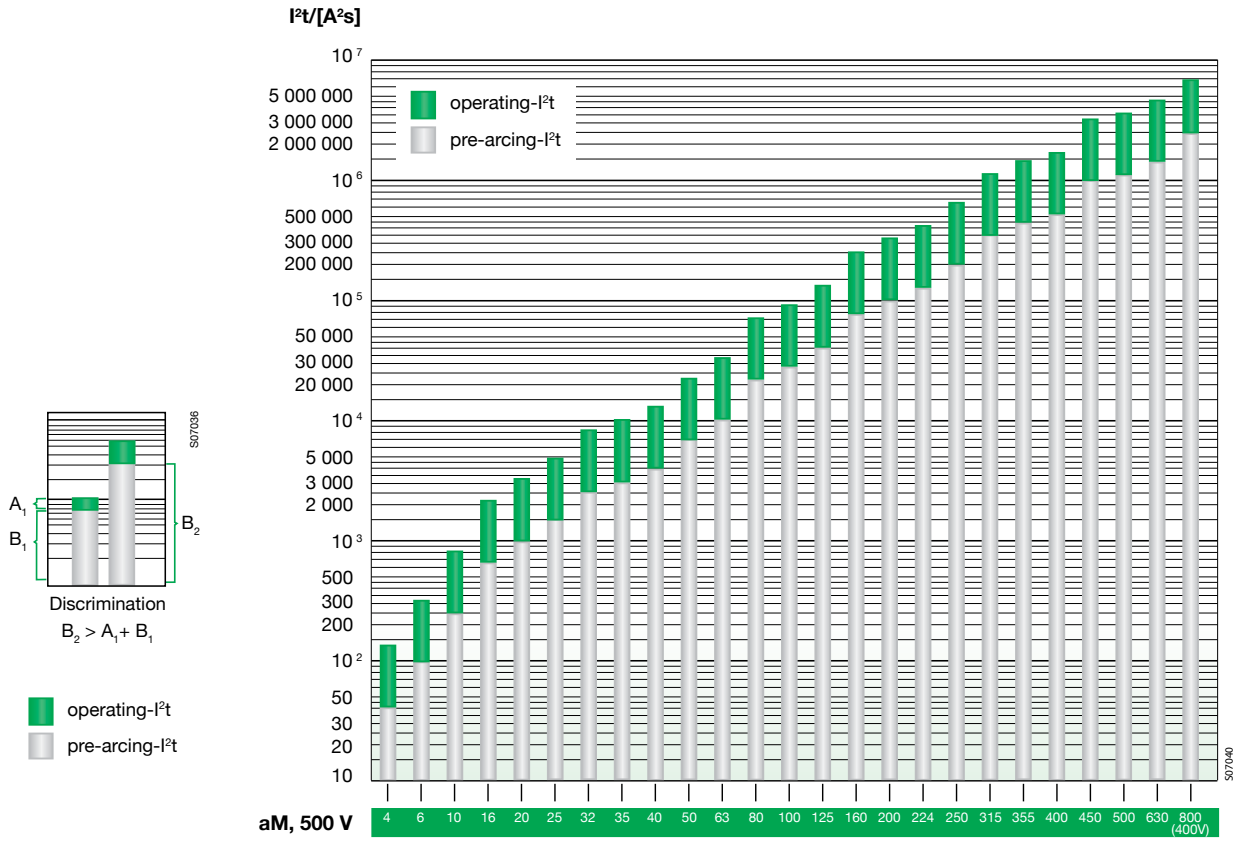

Fusegear Dimensions

BS Type

OFFN_fuse links

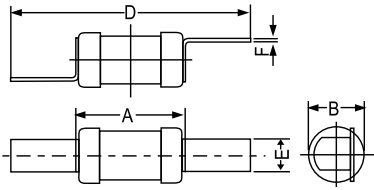

BS-Fuse size	A	B	D	E	F
F1	34.5	13.5	60	12.5	0.8

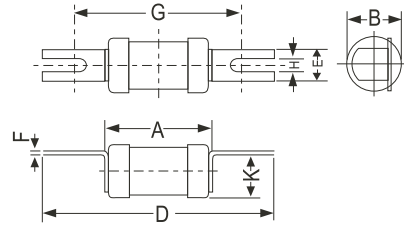

BS Fuse size	A	B	D	E	F	G	H	K
A1	35.5	13.5	56	11.2	0.8	44.5	4.8	13.7

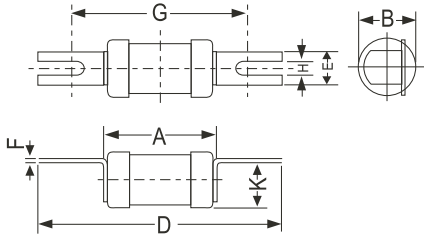

BS Fuse Size	A	B	D	E	F	G	H	K
A3	54.5	21.8	86.5	12.7	1.2	73	5.5	22.05

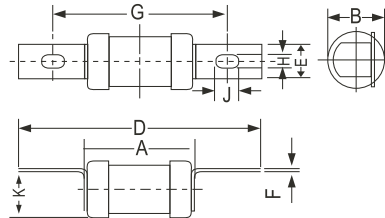

BS Fuse Size	A	B	D	E	F	G	H	J	K
A2	34.5	13.5	84.5	9	1	73	5.5	8	13.25
A4	57.5	26.9	109	19	2.4	94	8.7	11.5	25.85
-	58.5	21	110	14.3	3.2	94	8.7	11	21.3
B1 (80 & 100A)	56	21	125	14.3	3.2	111	8.7	11	13.35
B2	47	31	136	19	3.2	111	9	12.5	22.45

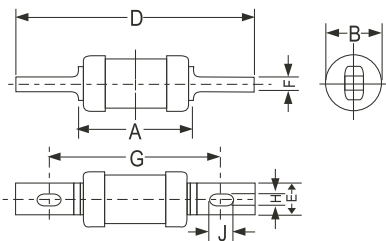

BS Fuse Size	A	B	D	E	F	G	H	J
B1 (50-63A)	56	26.9	135	19	3.2	111	8.7	14
B3	71.5	41.9	135	19	3.2	111	8.7	14
B4	73	59.1	135	25.6	4.8	111	8.7	14

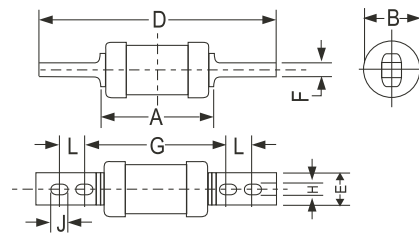

BS Fuse Size	A	B	D	E	F	G	H	J	L
C1	73	59.1	210	25.6	4.8	133	10.6	16	25.4
C2	81	74.3	210	25.6	6.3	133	10.6	16	25.4
C3	84	82.9	210	25.6	9.6	133	10.6	16	25.4

Fusegear Dimensions

DIN Type

gG- and aM- fuse links
OFAF_H_, OFAA_GG_

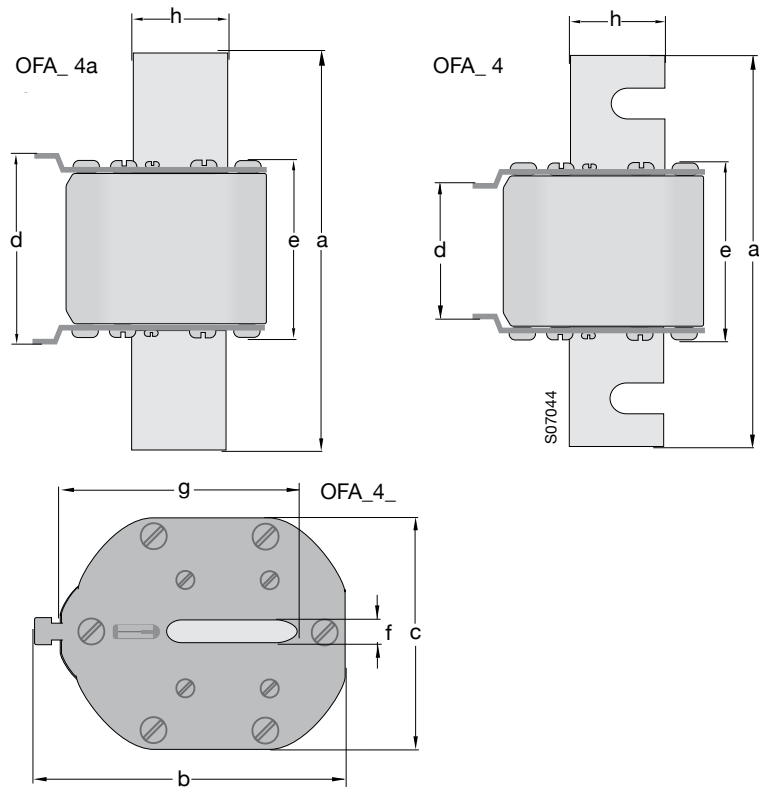
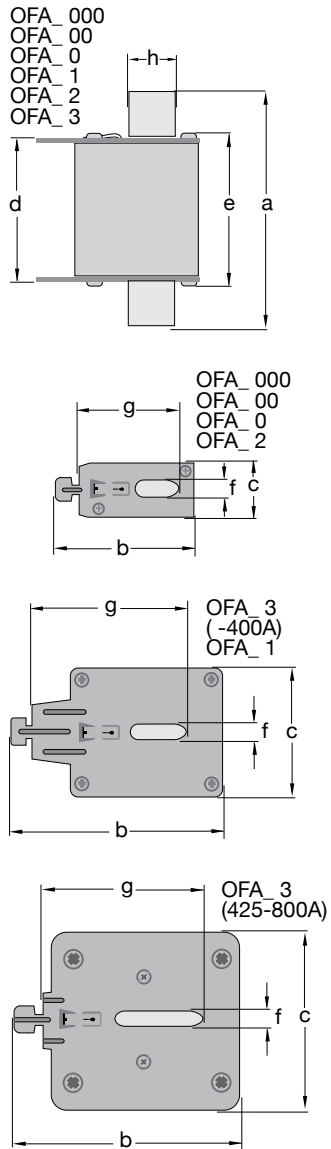

Fuse link	IEC-size	a	b	c	d	e	f	g	h
OFA_000_	000	79	52,5	20,8	49,5	52	6	35	15
OFA_00	00	79	59,5	29,5	50	52,8	6	35	15
OFA_0_6-160	0	125	59,5	29,5	66	66,8	6	35	15
OFA_0_200-250	0	125	59,5	39,5	66	66,8	6	35	20
OFA_1_16-100	1	135	64,5	29,5	68	70,8	6	40	15
OFA_1_125-315	1	135	66	39,5	68	70,8	6	40	20
OFA_2_35-250	2	150	72	39,5	68	72,3	6	48	20
OFA_2_300-500	2	150	72	51	68	72,3	6	48	26
OFA_3_250-400	3	150	83,5	51	68	72,3	6	60	26
OFA_3_425-800	3	150	86	70	68	72,3	6	60	33
OFA_4_	4	200	119	89	68	85	8	85	49
OFA_4A_	4a	200	119	89	88	85	8	85	49

Contact us

ABB Ltd

Tower Court
Foleshill Enterprise Park
Courtaulds Way
Coventry CV6 5NX

Tel: 0333 999 9900

Fax: 0333 999 9901

Email: LV.Enquiries@gb.abb.com

Twitter: @ABBUKLV

www.abb.co.uk/lowvoltage

Note: We reserve the right to make technical changes or modify the contents of this document without prior notice. With regard to purchase orders, the agreed particulars shall prevail. ABB Ltd does not accept any responsibility whatsoever for potential errors or possible lack of information in this document.

We reserve all rights in this document and in the subject matter and illustrations contained therein. Any reproduction, disclosure to third parties or utilization of its contents – in whole or in parts – is forbidden without prior written consent of ABB Ltd.

Copyright © 2015 ABB Ltd
All rights reserved