



# Mureva, Thalassa

Surface mounted boxes for rough  
and damp environments



Catalogue | 01/2016

[schneider-electric.com](http://schneider-electric.com)

Life Is On

**Schneider**  
Electric™







---

<b>Presentation.....</b>	<b>4</b>
<b>Mureva boxes.....</b>	<b>10</b>
Selection guide .....	10
Characteristics.....	12
Junction boxes - IP55.....	14
Accessories .....	17
Dimensions.....	21
<b>Thalassa boxes.....</b>	<b>24</b>
Selection guide .....	24
TBS - TBP characteristics .....	26
Common accessories .....	27
Specific accessories .....	28
Dimensions.....	33
<b>Properties of the plastic materials.....</b>	<b>37</b>
Mechanical, electrical, physical and fire-resistance properties.....	37
Resistance to chemical agents .....	38
<b>Index.....</b>	<b>40</b>



# Mureva & Thalassa boxes: easy to choose, easy to install

Sometimes you need electricity where it is quite difficult to install it, like in wet or dusty places, or where electricity has not been planned at all. The Mureva & Thalassa boxes satisfy any high safety requirement that the business might have, all surface mounted installations can be made irrespective of environment or safety needs. The boxes can be installed in residential, tertiary or industrial environments. They are easy to install, they are stable, they are halogen-free and self extinguishing. You can equip them according to your specific needs or buy them as complete junction boxes. With Mureva & Thalassa at hand, no job will be too demanding!



## Wide

choice of sizes and uses, wide range of accessories, Eco-designed,



► Wherever security and tightness are required



Safety  
Class II  
**double  
isolation**



Watertightness  
**IP55 - IP66**



Robustness  
**IK07 - IK08**



Environment  
**"Eco-designed"**

Check the Product Environmental Profile (PEP) on  
[www.schneider-electric.com](http://www.schneider-electric.com)





# IP55/66 - for rough and damp environments

Every rough environment presents an obvious risk that electric installations become exposed to water or dust. The Mureva & Thalassa ranges of Schneider Electric offer a wide range of possibilities to provide safe installations in rough environments. The ease and fast time of installation bring to these ranges their most important advantage.



## Where to install

All the environments, indoors as well as outdoors, exposed to water and dust like industry, farms, parking facilities home and professional laundries...



**+** If you want to continue saving time in your installation you must use the Mureva GT conduits

All our Mureva GT conduits are equipped with longitudinal grooves which offer much less frictional resistance than conventional conduits. Studies have shown that the cable installation time can be reduced by up to **55%** and installation efforts by up to **60%**. Try it out – you can really feel the difference!

**Mureva & Thalassa, easy to choose, easy to use**

► There are inevitably a size that suits you

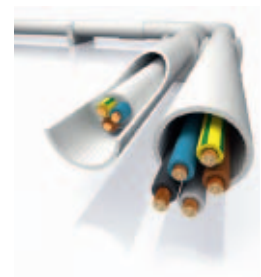
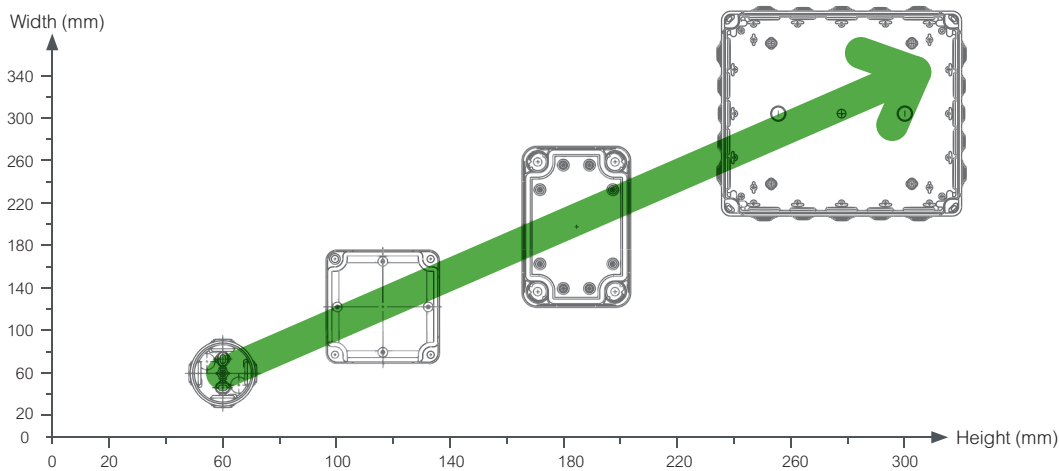



# Mureva boxes: easy to choose, easy to Install

The Mureva range of surface-mounted boxes is wide and feature-rich. Specifically designed for components requiring sturdiness and watertightness, they are best installed in the tertiary and residential sectors.

The various ways in which they can be mounted and connected make them indispensable for exposed installations. Sealed entries, oblong holes, junction boxes (terminal blocks), reinforced fire-resistant models... a wide variety of possibilities and facilities await you.

These boxes are part of an even wider range of reinforced IP and IK wiring equipment: flush-mounted boxes, switches and power sockets, conduits, enclosures, etc.



## Wide

choice of sizes and uses, wide range of accessories, Eco-designed,

### ► Your choice of dimensions



### ► Your choice of waterproof junction boxes



Boxes with grommets for direct entry



Boxes without entries



Boxes with knock-outs

### ► Specific applications



Security boxes 960°C

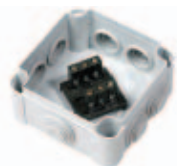

Boxes pre-equipped with terminal blocks



Safety  
Glow wire test:  
**650 to  
960°C**



Safety  
Class II:  
**double  
isolation**



Watertightness  
**IP55**





# IP55 protection – for rough and damp environments

Mureva boxes have been developed in a spirit of safety and respect for the planet. Halogen-free, they give off far fewer dangerous combustion gases. And by their very nature, they are less polluting.



## Where to install

All the environments, indoors as well as outdoors, exposed to water and dust like Industry, farms, parking facilities ...



### An easy installation



With a threaded plug

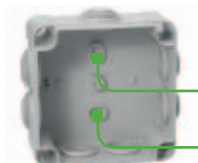

Oblong holes  
Central stud

With a standard screw + plug



With a gas or powder nailer.



Outside the waterproof space  
• Through the chimneys  
• Using fixing lugs.

### Exclusive



Two universal fixings:

- for mesh trays
- for cable trays and IPN profiles.

### An easy cable entry



System of grommets with direct entry  
• Conduits entry after removing a step  
• Direct cable entry by pushing.

### An easy closing



#### 1/4-turn screws



- Captive screws
- Closing visually identifiable, the arrow of the screw pointing towards the center of the box.

#### Clipped cover



- Waterproofness assured by the double lips
- Tool necessary to open the box.



Check the Product Environmental Profile (PEP) on [www.schneider-electric.com](http://www.schneider-electric.com)



# Thalassa boxes: robustness and safety

Thalassa boxes are the answer to the continuous evolution of the industry. They have been designed to withstand the toughest environmental conditions. Its rounded shape avoids any kind of water and dust accumulation. They are easy to install and machine. The Thalassa boxes meet all the international certifications according to IEC62208 standard. Class II: double insulation. Insulating material, self extinguishing and halogen free.

- ABS & polycarbonate versions.
- Faces lines (without grommets).

## ► This range can be configured according to your needs



### Machining

- Make square and circle cut-outs before painting the enclosure (body, cable gland plate, sides) and mounting plates
- +
- Ensures safety and the best protection against rust
- +
- The enclosure is ready to be equipped



### Mounting of standard accessories

- Pre-installation of accessories inside or out-side of the enclosure (ex.: mounting plate, plinth, canopy, etc.)
- +
- Enclosure ready to be equipped



### Painting

- Change the colour of the complete enclosure (choice of 36 colours)
- Modify the coating of the raw material (ex.: zinc, etc.)
- +
- Industrial painting ensures the best protection
- +
- Totally customized



### Packaging

- Just ask how many Thalassa products you want in each chipping box

## ► Insulating industrial boxes



- ABS for conventional applications (IK07) with the usual constraints,
- polycarbonate for enhanced impact resistance (IK08) and for outdoor applications or applications directly exposed to UV,
- polycarbonate certified UL.

## ► Smart



- Fixing studs on the cover.
- specific: transparent cover.



# Watertightness – IP66 for all ranges

Thalassa is not only specifically designed for industrial use and for aggressive tertiary environments. This range will find a prominent place in the residential sector: cellars, garages, workshops, utility rooms, boiler rooms... Its reinforced IP and IK products make it ideal for use in places where a high degree of safety, sturdiness and watertightness is required.

## ◀ Your choice of dimensions



## ◀ An easy installation



3 methods of fixing the box to its support.

## ◀ Easy to use

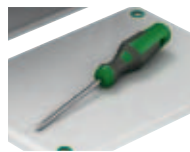

Only one tool is required: a flat screwdriver.

## ◀ Main application

### Electrical distribution

Receive and protect electrical & electronic components and control devices

### Junctions

### Electronics

### Universal

### Dedicated applications

### Shunting

### Industrial automatism



- Anti-condensation valves available as an accessory, prevent the build-up of moisture inside the box.





### Boxes with knock-outs IP55 - IK07

E101244d



AC\_01396



Overall external dimensions			Overall internal dimensions			Number of knock-outs					Standard	For security circuits
(mm)			(mm)			(Ø min. - max.)					Grey	Red
Height	Width	Depth	Height	Width	Depth	12/16	16/20	20/25	25/32	32/40	650°C	960°C

Cover clipped-on

74	74	52	65	65	45	-	4	-	-	-	ENN05082	-
89	89	52	80	80	45	-	4	-	-	-	ENN05084	ENN05174
116	74	62	105	65	55	-	6	-	-	-	ENN05083	-

E101246d



AC\_01395



Overall external dimensions			Overall internal dimensions			Number of knock-outs					Standard	For security circuits
(mm)			(mm)			(Ø min. - max.)					Grey	Red
Height	Width	Depth	Height	Width	Depth	12/16	16/20	20/25	25/32	32/40	750°C	960°C

Cover quarter-turn screws

115	115	62	105	105	55	-	7	-	-	-	ENN05085	ENN05175
164	121	87	150	105	80	8	4	2	-	-	ENN05087	ENN05177
193	164	88	175	150	80	8	-	4	4	-	ENN05090	-
241	194	108	225	175	100	-	-	6	-	6	ENN05093	-
292	242	128	275	225	120	-	-	16	-	8	ENN05097	-
342	292	129	325	275	120	-	-	24	-	8	ENN05099	-

### Boxes without entries IP55 - IK07

E101242d



Overall external dimensions			Overall internal dimensions			Standard	
(mm)			(mm)			Grey	White
Height	Width	Depth	Height	Width	Depth	650°C	

Cover clipped-on

89	89	52	80	80	45	ENN05044	ENN05064
----	----	----	----	----	----	----------	----------

GY9E0019

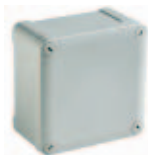

Overall external dimensions			Overall internal dimensions			Standard	
(mm)			(mm)			Grey	White
Height	Width	Depth	Height	Width	Depth	750°C	

Cover quarter-turn screws

115	115	62	105	105	55	ENN05045	ENN05065
164	121	87	150	105	80	ENN05047	-
193	164	88	175	150	80	ENN05050	-
241	194	108	225	175	100	ENN05053	-
292	242	128	275	225	120	ENN05057	-
342	292	129	325	275	120	ENN05059	-

### Boxes with grommets IP55 - IK07



Overall external dimensions			Overall internal dimensions			Number of grommets				Standard		With terminal blocks	For security circuits	
(mm)			(mm)			(Ø min. - max.)				Grey	White	Grey	Red	Grey
Height	Width	Depth	Height	Width	Depth	4/20	4/25	4/32	4/40	650°C		650°C	960°C	
<b>Cover clipped-on</b>														
Ø	72	50	Ø	60	40	4	-	-	-	ENN05001	ENN05021	-	-	-
82	82	52	65	65	45	4	-	-	-	ENN05002	ENN05022	-	-	-
						7	-	-	-	ENN05032	ENN05072	-	-	-
97	97	52	80	80	45	7	-	-	-	ENN05004	ENN05024	ENN05204	ENN05164	ENN05264
124	82	62	105	65	55	8	-	-	-	ENN05003	ENN05023	-	-	-



Overall external dimensions			Overall internal dimensions			Number of grommets				Standard		With terminal blocks	For security circuits	
(mm)			(mm)			(Ø min. - max.)				Grey	White	Grey	Red	Grey
Height	Width	Depth	Height	Width	Depth	4/20	4/25	4/32	4/40	750°C		750°C	960°C	
<b>Cover quarter-turn screws</b>														
128	128	62	105	105	55	-	7	-	-	ENN05005	ENN05025	ENN05205	ENN05165	ENN05265
172	129	87	150	105	80	-	10	-	-	ENN05007	-	-	ENN05167	ENN05267
200	176	88	175	150	80	-	10	2	-	ENN05010	-	-	-	-
251	204	108	225	175	100	-	4	8	-	ENN05013	-	-	-	-
302	255	128	275	225	120	-	-	16	4	ENN05017	-	-	-	-
355	305	129	325	275	120	-	-	10	10	ENN05019	-	-	-	-

# Mureva boxes

## Characteristics

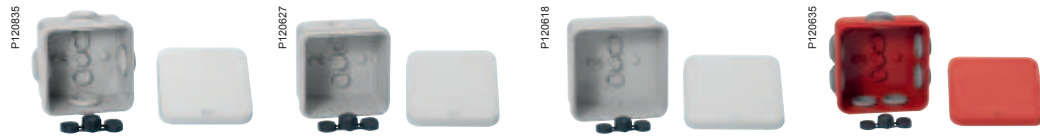

Characteristics	Boxes with grommets	Boxes with knock-outs	Boxes without entries	Boxes security circuits
	<p>The Mureva BOX range of junction boxes is available in ten sizes, varying from the small round Ø 60 x 40 mm to the spacy rectangular 325 x 275 x 120 mm</p> <ul style="list-style-type: none"> <li>■ The boxes come in one of three entry versions:                             <ul style="list-style-type: none"> <li><input type="checkbox"/> with grommets</li> <li><input type="checkbox"/> with knock-outs</li> <li><input type="checkbox"/> without entries (solid faces)</li> </ul> </li> <li>■ Versions with extended temperature resistance (glow wire test 960°C) are available</li> </ul> <p>All boxes in sizes up to 105 x 65 x 55 mm have clipped-on covers, while bigger ones use four quarter-turn screws                      All boxes are packed in plastic film, enabling fast recognition of the product                      Small boxes (up to size 105 x 105 x 55 mm) are packed in fives, whereas large boxes are packed by the piece                      The products respect environmental needs, which is assured by halogen-free plastic materials (except slightly halogenated red boxes) and the use of eco-design rules (product environmental profile)</p>			
Material, box and cover	<ul style="list-style-type: none"> <li>■ The junction boxes with grommets are available in all ten sizes</li> <li>■ The grommet diameters are 20, 25, 32 or 40 mm, depending on the box</li> </ul>	<ul style="list-style-type: none"> <li>■ The junction boxes with knock-outs are available in nine sizes (no small round box) with ISO diameters from M12 up to M40, depending on the box</li> <li>■ Metric knock-outs usually have two consecutive ISO sizes in each location, e.g. ISO 16/20 or ISO 20/25, etc</li> <li>■ The exception is for small boxes (up to 80 x 80 x 45 mm), which only have a single knock-out ISO 20 in each location</li> </ul>	<ul style="list-style-type: none"> <li>■ The junction boxes with solid walls are available in seven sizes (from 80 x 80 x 45 mm to 325 x 275 x 120 mm)</li> </ul>	<p>The junction boxes for security circuits are available in three sizes (80 x 80 x 45 mm, 105 x 105 x 55 and 150 x 105 x 80 mm) with two entry versions:</p> <ul style="list-style-type: none"> <li>■ <b>with grommets:</b> the grommet diameters are 20 or 25 mm, depending on the box</li> <li>■ <b>with knock-outs:</b> the knock-out diameters are M12, M16, M20 or M25, depending on the box. Metric knock-outs have two consecutive ISO sizes in each location, i.e. ISO 12/16, 16/20 and 20/25</li> </ul>
	<p><b>Boxes ≤ 105 x 105</b></p> <ul style="list-style-type: none"> <li>■ Halogen-free</li> <li>■ Insulating material:                             <ul style="list-style-type: none"> <li><input type="checkbox"/> body made of ABS</li> <li><input type="checkbox"/> cover made of PP</li> </ul> </li> </ul> <p><b>Large boxes</b></p> <ul style="list-style-type: none"> <li>■ Halogen-free</li> <li>■ Insulating material: body and cover made of PP</li> </ul> <p><b>Red boxes</b></p> <ul style="list-style-type: none"> <li>■ Slightly halogenated</li> <li>■ Insulating material: body and cover made of PP (960°C glow wire test)</li> </ul> <p><b>Operating temperature</b></p> <ul style="list-style-type: none"> <li>■ -25°C...+40°C</li> </ul> <p><b>Flame resistance</b></p> <ul style="list-style-type: none"> <li>■ 650°C for boxes &lt; 105 x 105 mm</li> <li>■ 750°C for boxes ≥ 105 x 105 mm</li> <li>■ 960°C for red and grey boxes</li> </ul>			
Colour	<ul style="list-style-type: none"> <li>■ Standard grey series: RAL 7035 grey</li> <li>■ Standard white series: RAL 9010 white</li> <li>■ Red series: RAL 3000 red</li> </ul>			
Ingress protection rating	IP55 to standard IEC 60529 Class II to IEC 536 assured by protection caps (supplied) and fixing screws			
Mechanical protection rating	IK07 (2J) according to EN50102			
Standards	Conforming to standard EN 60670			
Certifications	<ul style="list-style-type: none"> <li>■ EN 60670 certified by TÜV</li> <li>■ AENOR (pending)</li> </ul>			
Installation	<p><b>Fixing the box</b></p> <ul style="list-style-type: none"> <li>■ Boxes up to 105 x 105:                             <ul style="list-style-type: none"> <li><input type="checkbox"/> single fixing central point (e.g. using powder nailer)</li> <li><input type="checkbox"/> through box bottom, using two oblong knock-out holes (also by using gas nailer)</li> </ul> </li> <li>■ Large boxes:                             <ul style="list-style-type: none"> <li><input type="checkbox"/> outside usable volume, using four chimneys at box corners</li> <li><input type="checkbox"/> through box bottom, using two or four (depending on size) oblong knock-out holes</li> </ul> </li> </ul>			
Benefits	<ul style="list-style-type: none"> <li>■ Wide choice:                             <ul style="list-style-type: none"> <li><input type="checkbox"/> wide dimensional range with 10 sizes</li> <li><input type="checkbox"/> three types of entries (walls) to suit all installation methods</li> <li><input type="checkbox"/> boxes for specific applications (security circuits, pre-equipped with terminals)</li> </ul> </li> <li>■ Safety: IP range also assured by gaskets and protection caps (supplied)</li> <li>■ Ease of installation:                             <ul style="list-style-type: none"> <li><input type="checkbox"/> quick cover closing, either by clipping-in (small boxes) or by captive quarter-turn screws assuring IP55 protection</li> <li><input type="checkbox"/> captive cover, with a link between body and cover, facilitating installation</li> <li><input type="checkbox"/> the four "feet" of the cover of boxes 105 x 105 x 55 and larger ensure rigidity and perfect stability during machining operations (e.g. customisation)</li> <li><input type="checkbox"/> several solutions for box fixing:                                     <ul style="list-style-type: none"> <li>- central point (small boxes)</li> <li>- oblong holes</li> <li>- chimneys outside the IP zone (large boxes)</li> </ul> </li> </ul> </li> </ul>			
Product Environmental Profile	Product Environmental Profile documents are available on <a href="http://www.schneider-electric.com">www.schneider-electric.com</a>			



## Surface mounted boxes

# Mureva boxes

## Characteristics

P1100907



P180928



P180959



P120839



P180954









Characteristics	For fixing	For cable entry	For protection	For coupling	For cabling
	Universal fixing for metal beams and cable trays	<ul style="list-style-type: none"> <li>■ Flexible entries (grommets with diameters 20 - 40 mm)</li> <li>■ Cable glands and gaskets</li> <li>■ Multi-cable discs</li> </ul>	Various plugs for transport and ventilation	<ul style="list-style-type: none"> <li>■ Coupling kit to connect two boxes</li> </ul>	<ul style="list-style-type: none"> <li>■ Terminals</li> <li>■ Support bars and mounting plate for terminal blocks</li> </ul>

### References\*



\* For details, type reference in the search engine of [www.schneider-electric.com](http://www.schneider-electric.com)



### Junction boxes with grommets

	Dimensions H x L x W (mm)	Type	Colour	Reference	Qty per package
<b>Junction box with clipped-on cover</b>					
P120834 	Ø 60 x 40	4 grommets Ø 20	Grey	ENN05001	5
			White	ENN05021	
P120835 	65 x 65 x 45	4 grommets Ø 20	Grey	ENN05002	5
	65 x 65 x 45	7 grommets Ø 20	White	ENN05022	
P120831 			80 x 80 x 45	7 grommets Ø 20	Grey
	80 x 80 x 45	7 grommets Ø 20 and terminal blocks	White	ENN05024	
P120825 			105 x 65 x 55	8 grommets Ø 20	Grey
	White	ENN05023			
<b>Junction box with screw-fixed cover</b>					
P120823 	105 x 105 x 55	7 grommets Ø 25	Grey	ENN05005	5
			White	ENN05025	
P120810 	105 x 105 x 55	7 grommets Ø 25 and terminal blocks	Grey	ENN05205	5
	150 x 105 x 80	10 grommets Ø 25	Grey	ENN05007	1
	175 x 150 x 80	10 grommets Ø 25 and 2 grommets Ø 32	Grey	ENN05010	1
	225 x 175 x 100	4 grommets Ø 25 and 8 grommets Ø 32	Grey	ENN05013	1
	275 x 225 x 120	16 grommets Ø 32 and 4 grommets Ø 40	Grey	ENN05017	1
	325 x 275 x 120	10 grommets Ø 32 and 10 grommets Ø 40	Grey	ENN05019	1

### Junction boxes with grommets, DIY

	Dimensions H x L x W (mm)	Type	Colour	Reference	Qty per package
<b>Junction box with clipped-on cover</b>					
P120834 	Ø 60 x 40	4 grommets Ø 20	Grey	ENN05121	1
			White	ENN05121	
P120835 	65 x 65 x 45	7 grommets Ø 20	Grey	ENN05142	1
	80 x 80 x 45	7 grommets Ø 20	Grey	ENN05124	
<b>Junction box with screw-fixed cover</b>					
P120823 	105 x 105 x 55	7 grommets Ø 25	Grey	ENN05125	1







## Surface mounted boxes



# Mureva boxes

## Junction boxes - IP55

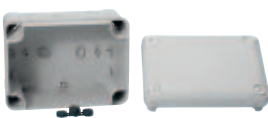
### Junction boxes with knock-outs



	Dimensions H x L x W (mm)	Type	Colour	Reference	Qty per package
 P120627	<b>Junction box with clipped-on cover</b>				
	Surface mounted junction box with metric knock-outs and clipped-on cover. Degree of protection IP55, mechanical protection IK07, flame resistance 650°C. Material: ABS (body), PP (cover).				
	65 x 65 x 45	4 knock-outs M16/20	Grey	ENN05082	5
	80 x 80 x 45	4 knock-outs M16/20	Grey	ENN05084	5
	105 x 65 x 55	6 knock-outs M16/20	Grey	ENN05083	5
 P120613	<b>Junction box with screw-fixed cover</b>				
	Surface mounted junction box with metric knock-outs and quarter-turn screw-fixed cover. Degree of protection IP55, mechanical protection IK07, flame resistance 750°C. Material: PP.				
 P120608	105 x 105 x 55	7 knock-outs M16/20	Grey	ENN05085	5
	150 x 105 x 80	8 knock-outs M12/16, 4 x M16/20 and 2 x M20/25	Grey	ENN05087	1
	175 x 150 x 80	8 knock-outs M12/16, 4 x M20/25 and 4 x M25/32	Grey	ENN05090	1
	225 x 175 x 100	6 knock-outs M20/25 and 6 x M32/40	Grey	ENN05093	1
	275 x 225 x 120	16 knock-outs M20/25 and 8 x M32/40	Grey	ENN05097	1
	325 x 275 x 120	24 knock-outs M20/25 and 8 x M32/40	Grey	ENN05099	1

### Junction boxes without entries



	Dimensions H x L x W (mm)	Type	Colour	Reference	Qty per package
 P120618	<b>Junction box with clipped-on cover</b>				
	Surface mounted junction box with solid walls and clipped-on cover, without entries. Degree of protection IP55, mechanical protection IK07, flame resistance 650°C. Material: ABS (body), PP (cover).				
	80 x 80 x 45	Junction box without entries	Grey White	ENN05044 ENN05064	5 5
 P120611	<b>Junction box with screw-fixed cover</b>				
	Surface mounted junction box with solid walls and quarter-turn screw-fixed cover, without entries. Degree of protection IP55, mechanical protection IK07, flame resistance 750°C. Material: PP.				
	105 x 105 x 55	Junction box without entries	Grey White	ENN05045 ENN05065	5 5
	150 x 105 x 80	Junction box without entries	Grey	ENN05047	1
	175 x 150 x 80	Junction box without entries	Grey	ENN05050	1
	225 x 175 x 100	Junction box without entries	Grey	ENN05053	1
	275 x 225 x 120	Junction box without entries	Grey	ENN05057	1
	325 x 275 x 120	Junction box without entries	Grey	ENN05059	1







### Security boxes with grommets

	Dimensions H x L x W (mm)	Type	Colour	Reference	Qty per package
 <p>P120635</p>	80 x 80 x 45	7 grommets Ø 20 mm	Red	<b>ENN05164</b>	5
			Grey	<b>ENN05264</b>	
<b>Junction box for security circuits, with screw-fixed cover</b>					
Surface mounted junction box for security circuits, with grommets and quarter-turn screw-fixed cover. Degree of protection IP55, mechanical protection IK07, flame resistance 960°C. Material: PP.					
 <p>P120626</p>	105 x 105 x 55	7 grommets Ø 25 mm	Red	<b>ENN05165</b>	5
	150 x 105 x 80	10 grommets Ø 25 mm	Grey	<b>ENN05265</b>	1
			Red	<b>ENN05167</b>	
Grey	<b>ENN05267</b>				



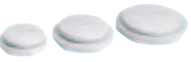

### Security boxes with knock-outs

<b>Junction box for security circuits, with clipped-on cover</b>					
Surface mounted junction box for security circuits, with metric knock-outs and clipped-on cover. Degree of protection IP55, mechanical protection IK07, flame resistance 960°C. Material: PP.					
 <p>P120619</p>	80 x 80 x 45	4 knock-outs M16/20	Red	<b>ENN05174</b>	5
<b>Junction box for security circuits, with screw-fixed cover</b>					
Surface mounted junction box for security circuits, with metric knock-outs and quarter-turn screw-fixed cover. Internal dimensions 105 x 80 x 150 mm. Degree of protection IP55, mechanical protection IK07, flame resistance 960°C. Material: PP.					
 <p>P120639</p>	105 x 105 x 55	7 knock-outs M16/20	Red	<b>ENN05175</b>	5
	150 x 105 x 80	8 knock-outs M12/16, 4 x M16/20 and 2 x M20/25	Red	<b>ENN05177</b>	1

### Accessories for cable entries with strain relief

	ISO diameter	Diameter of cable/ conduit (mm)	No of diameters	Colour	Reference	Qty per package
<b>Cable glands acc. to ISO standard</b>						
 <p>P60928</p>	Cable gland equipped with nut and neoprene seal for one cable. May be used both for threaded and unthreaded holes. The IP68 classification assures complete protection. The temperature range is between -30° and +80°C permanently and up to +150°C intermittently. Material: PA6.					
	M12	Ø 3 / 6.5		Grey RAL 7035	ISM71501	20
	M16	Ø 4 / 8		Grey RAL 7035	ISM71502	20
	M20	Ø 6 / 12		Grey RAL 7035	ISM71503	20
	M25	Ø 11 / 17		Grey RAL 7035	ISM71504	10
	M32	Ø 15 / 21		Grey RAL 7035	ISM71505	10
	M40	Ø 19 / 28		Grey RAL 7035	ISM71506	5
<b>Security cable gland</b>						
 <p>P100965</p>	Security cable gland equipped with nut and seal for one cable, specially adapted to red boxes for safety circuits. May be used in both threaded and unthreaded holes. The IP68 and choice of plastic material ensures complete protection even in hot environments. Incandescent wire tested at 960°C. Material: PA6.					
	M20	Ø 6 / 12		Red RAL 3000	IMT36150	20
<b>Gasket</b>						
 <p>P100908</p>	Gasket for cable gland. To be used to ensure a tight fit and complete protection IP68 when mounting cable glands on rough surfaces. Material: EPDM rubber.					
	M12			Black	IMT36151	100
	M16			Black	IMT36152	100
	M20			Black	IMT36153	100
	M25			Black	IMT36154	50
	M32			Black	IMT36155	50
	M40			Black	IMT36156	25
<b>Multi-cable discs</b>						
 <p>P60958</p>	Multi-cable disc for cable glands. To be used for a secure fitting of multiple cables or wires through the same cable gland. Material: EPDM rubber					
	M16		2 x Ø 4	Black	IMT36157	40
	M20		3 x Ø 4	Black	IMT36158	40
	M25		4 x Ø 5	Black	IMT36159	20
	M32		6 x Ø 5	Black	IMT36160	20
<b>Transport plugs</b>						
 <p>P60959</p>	Transport plug for cable gland. To be used to seal a cable gland during transport, or when pre-assembling a cable gland for later use. Material: PA6.					
	M16			Black	IMT36167	40
	M20			Black	IMT36168	40
	M25			Black	IMT36169	20
	M32			Black	IMT36170	20
	M40			Black	IMT36171	10
<b>Blanking plugs</b>						
 <p>P100909</p>	Blanking plug including lock nut. To be used to seal openings in the box during transport, or as a protection for holes intended for later installations. Material: PA6.					
	M12			Grey RAL 7035	IMT36161	40
	M16			Grey RAL 7035	IMT36162	40
	M20			Grey RAL 7035	IMT36163	40
	M25			Grey RAL 7035	IMT36164	20
	M32			Grey RAL 7035	IMT36165	20
	M40			Grey RAL 7035	IMT36166	10





## Accessories for cable entries without strain relief

ISO diameter	Diameter of cable / conduit (mm)	Diameter of drilling (mm)	Colour	Reference	Qty per package	
<b>Grommets</b>						
Flexible grommet suitable for unthreaded holes. For fast installation by using either EVA (easy valve access) membrane entry, i.e. direct entry of rigid cables 4-14 mm <sup>2</sup> , or stepped entry, by removing a step of the desired diameter for cables or conduits from 14 mm <sup>2</sup> to 20, 25, 32 and 40 mm <sup>2</sup> respectively. Degree of protection IP55. Usage temperature: -25°C...+40°C. Material: SBS						
P120849 	4-20	Ø 23	Grey RAL 7035	<b>ISM71071</b>	10	
			White RAL 9010	<b>IMT36172</b>	10	
			Dark grey RAL 7004	<b>ENN08131</b>	10	
P120846 	4-25	Ø 29	Grey RAL 7035	<b>ISM71072</b>	10	
			White RAL 9010	<b>IMT36173</b>	10	
			Dark grey RAL 7004	<b>ENN08132</b>	10	
P120847 	4-32	Ø 36	Grey RAL 7035	<b>ISM71073</b>	10	
	4-40	Ø 44	Grey RAL 7035	<b>ISM71074</b>	10	
<b>TET grommets</b>						
Grommet suitable for holes with metric thread and various diameters. IP67 Material: EPDM						
P60948 	M12	Ø 3 / 5	Ø 12 - 13	Grey	<b>IMT36179</b>	50
	M16	Ø 5 / 7	Ø 16 - 17	Grey	<b>IMT36180</b>	50
	M20	Ø 7 / 10	Ø 20 - 21	Grey	<b>IMT36181</b>	50
	M25	Ø 10 / 14	Ø 25 - 26	Grey	<b>IMT36182</b>	50
	M32	Ø 14 / 20	Ø 32 - 33	Grey	<b>IMT36183</b>	50
	M40	Ø 20 / 26	Ø 40 - 41	Grey	<b>IMT36184</b>	25
	M50	Ø 26 / 35	Ø 50 - 51	Grey	<b>IMT36185</b>	25

## Accessories for coupling

Type	For boxes (mm)	For trunking (mm)	Color	Reference	Qty per package
<b>Coupling kit</b>					
Coupling M32 to be used to connect two boxes (from 105 x 105 mm) with M32 knock-outs. Enables side-by-side mounting of boxes without reduction of the IP classification Material: Polystyrene					
P120839 	Coupling	From 175 x 150 x 80	Grey	<b>13934</b>	2

## Accessories for fixing

<b>Universal fixing for IPN profiles and cable trays</b>					
Universal fixing intended for the fixing of < 105 x 105 mm (internal dimension) junction boxes on IPN profiles from 2 to 12 mm and all types of cable trays Material: Steel					
P100907 	Universal fixing		Grey	<b>ENN08167</b>	10
<b>Universal fixing for mesh trays</b>					
Universal fixing intended for the fixing of < 105 x 105 mm (internal dimension) junction boxes on all types of mesh trays Material: PA6 with 30% glass-fibre					
P120844 	Universal fixing		Grey	<b>ENN08162</b>	10
<b>M6 clip</b>					
Add-on accessory for the IPN profiles and cable trays fixing intended to enable the fixing with an M6 screw Material: Steel					
P120853 	M6 clip			<b>ENN48861</b>	10
<b>Fixing lugs</b>					
Fixing lugs intended for mounting of < 105 x 105 mm junction boxes. Fixing is made outside the waterproof space Material:					
P120861 	Fixing lugs			<b>NSYAEFTB</b>	4

### Accessories for cabling

Type	Colour	Reference	Qty per package	
<b>Mounting plate</b>				
Mounting plate for terminal blocks 2.5 mm <sup>2</sup> and 6 mm <sup>2</sup> in boxes 80 x 80 mm and 105 x 105 mm (internal dimensions). The plate enables mounting of eight 2.5 mm <sup>2</sup> blocks or two 6 mm <sup>2</sup> blocks or a combination of both. Material: PC.				
 P120643 P100938	Mounting plate	Anthracite RAL 7016	ENN08241	10
<b>Terminal blocks</b>				
6-pole push-in terminal block approved for max. 85°C. Max cable area 6 x 2.5 mm <sup>2</sup> . Material: PA.				
 P60938	Spring terminal 6 x 2.5 mm <sup>2</sup>	White	WDE0000010	100
3-pole screw-type terminal block. 440 V. Material: PA.				
 P60988	Screw terminal 3 x 6 mm <sup>2</sup>	Black	IMT36089	20
Earth terminal marked with an earth sign for easy recognition during maintenance operations. Material: CuZn37-R350/H095.				
	Earth terminal	Red	IMT34009	10
<b>4-hole terminal blocks</b>				
4-holes terminal block to be used together with support bar. Boxes from 175 x 150 mm (internal dimension) accept mounting of a 12 x 2 mm bar that can be used for easy clip-on of up to 8 terminal blocks (depending on sizes of bars and terminal blocks, see selection guide below). Material: Brass bars in a plastic housing.				
 P652585	Phase, 2 x 10 mm <sup>2</sup> + 2 x 16 mm <sup>2</sup>	Red	IMT34003	10
 P60954	Neutral, 2 x 10 mm <sup>2</sup> + 2 x 16 mm <sup>2</sup>	Blue	IMT34005	5
Terminal block like the above but supplied including a separate yellow sticker with the earth symbol. When required, the symbol can be stuck to the cover of the terminal block				
 P120793	Earth, 2 x 10 mm <sup>2</sup> + 2 x 16 mm <sup>2</sup>	Green	IMT34007	5
<b>Support bar</b>				
12 x 2 mm support bar for 4-holes terminal blocks. For easy clip-on up to 8 terminal blocks (depending on sizes of bars and terminal blocks, see selection guide below), which frees considerable space for introduction of cables. Including plastic feet and screws. Material: Galvanised steel bar on plastic feet.				
 P650294	Support bar Ls = 140 mm	-	IMT34000	1
	Support bar Ls = 185 mm	-	IMT34001	1
	Support bar Ls = 235 mm	-	IMT34002	1

### Selection guide

#### Number of terminal blocks per support bar

	Terminal block 2 x 10 mm <sup>2</sup> + 2 x 16 mm <sup>2</sup>	For boxes (mm)
Support bar 140 mm (ref. IMT34000)	4	175 x 150
	-	225 x 175
Support bar 185 mm (ref. IMT34001)	6	225 x 175
	-	275 x 225
	3	
Support bar 235 mm (ref. IMT34002)	8	275 x 225
	-	325 x 275
	3	
	4	







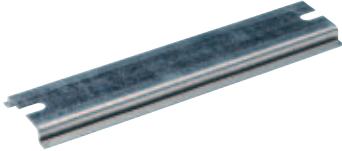

## Surface mounted boxes

# Mureva boxes Accessories

### Accessories for cabling

	Rail length (mm)	For boxes height (mm)	Reference for rail type	
			15 x 5 mm	35 x 7.5 mm
 P120662	97	105	NSYAMRD11155TB	NSYAMRD11357TB
	140	150	NSYAMRD16155TB	NSYAMRD16357TB
 P120683	168	175	NSYAMRD19155TB	NSYAMRD19357TB
	214	225	NSYAMRD24155TB	NSYAMRD24357TB
 P120664	264	275	NSYAMRD29155TB	NSYAMRD29357TB
	316	325	NSYAMRD34155TB	NSYAMRD34357TB

### Accessories for marking

	Color	Reference	Qty per package
<b>Marking tools</b>			
Identification sticker in red colour for marking of 960°C safety junction boxes Material: Paper			
 P120655 Safety stickers Pilote		ENN02290	10
Permanent marker pen for marking on boxes or stickers Material: Plastic			
 P120656 Permanent marker pen, blue		ENN08276	10
Sheet with 60 labels, 70 x 70 mm, for marking of boxes Material: Paper			
Label sheet	White	ENN08271	1





# Surface mounted boxes

# Mureva boxes Dimensions

## Box of Ø 60 x 40 mm

Interior with grommets

Side

Rear

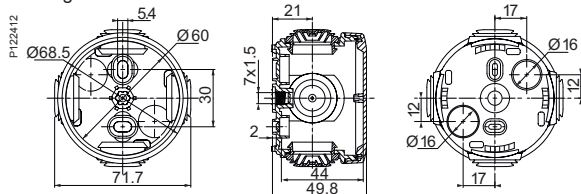

## Box of 65 x 65 x 45 mm

Interior with grommets

Interior

Side

Rear

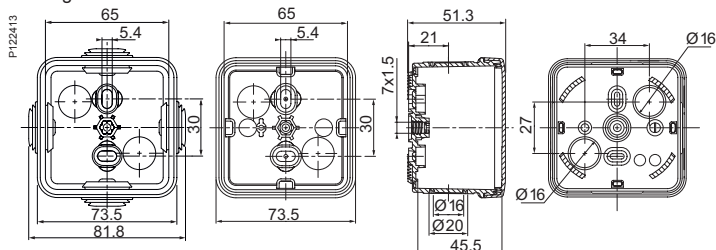

## Boîtes 80 x 80 x 45 mm

Interior with grommets

Interior

Side

Rear

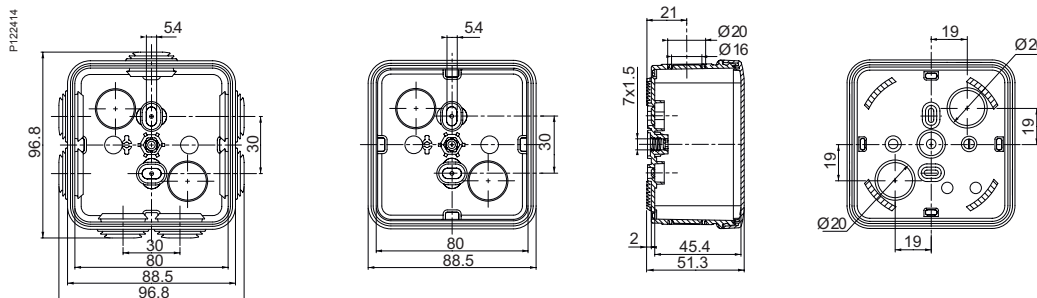

## Boîtes 105 x 65 x 55 mm

Interior with grommets

Interior

Side

Rear

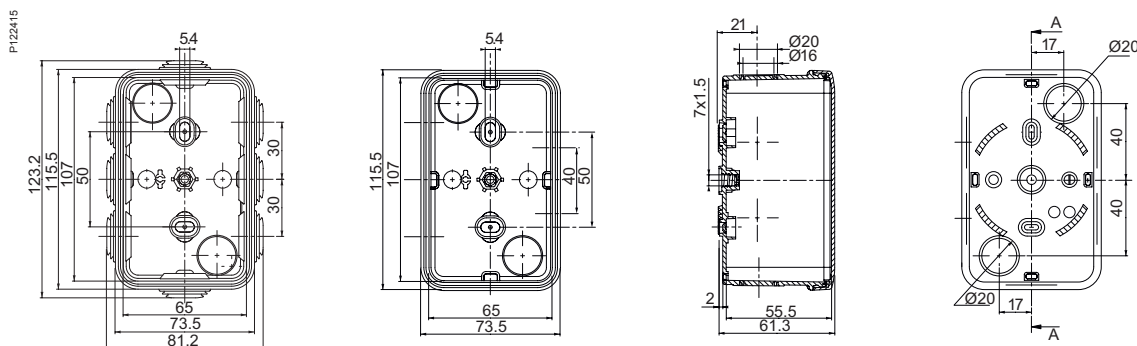

## Boîtes 150 x 105 x 80 mm

Interior with grommets

Interior

Side

Rear

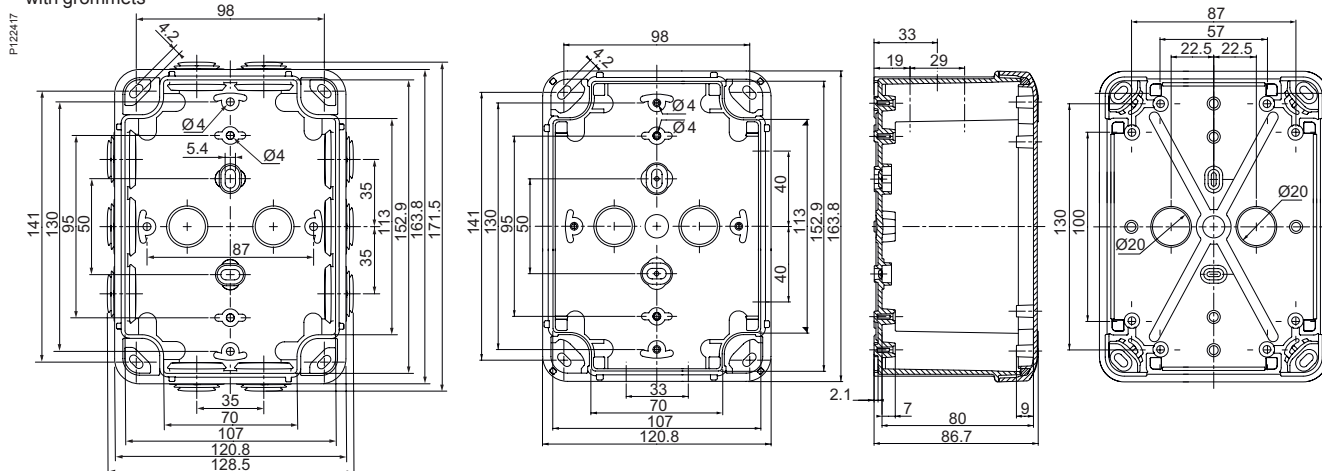



# Surface mounted boxes

# Mureva boxes Dimensions

## Boîtes 105 x 105 x 55 mm

Interior with grommets

Interior

Side

Rear

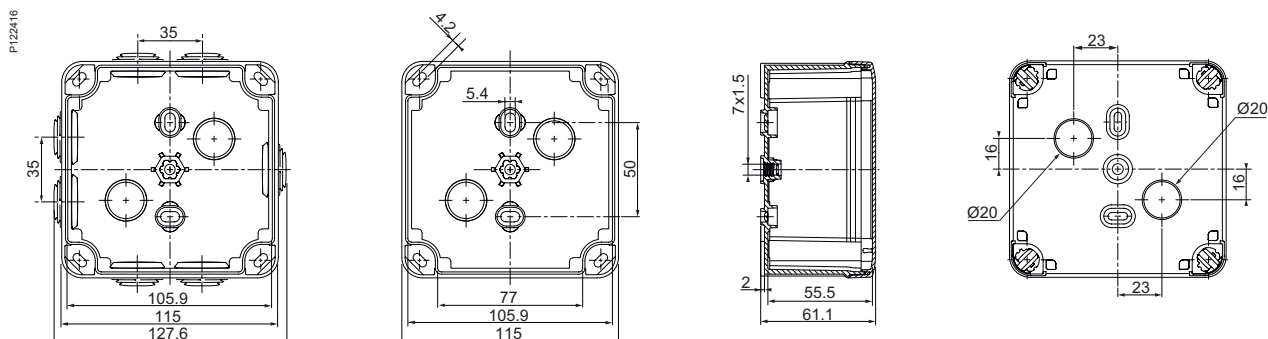

## Boîtes 175 x 150 x 80 mm

Interior with grommets

Interior

Side

Rear

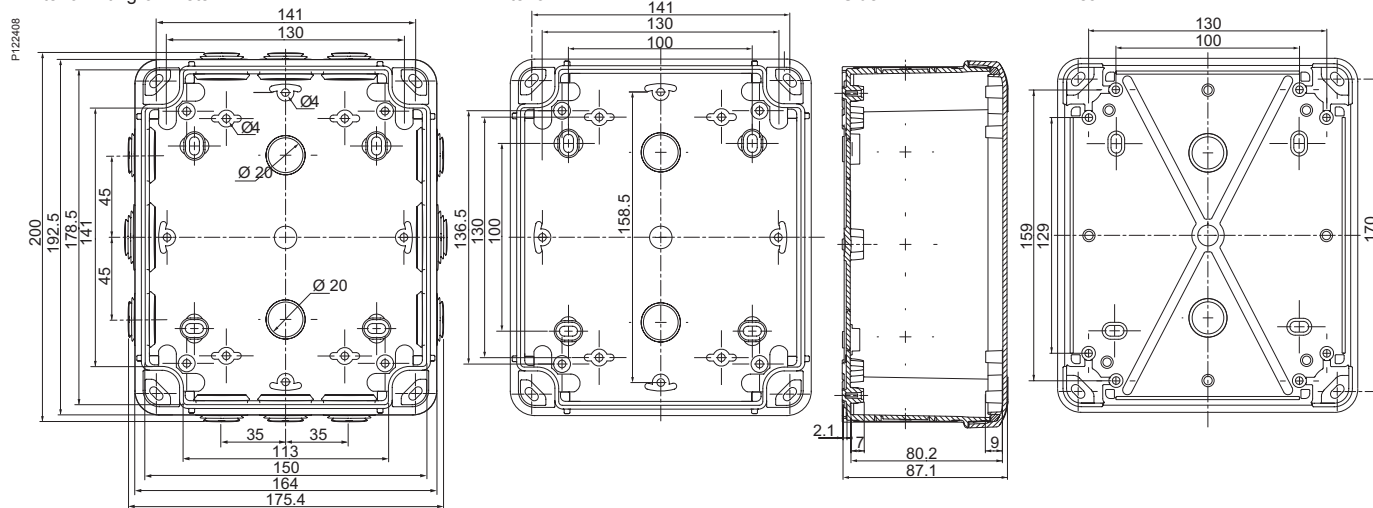

## Boîtes 225 x 175 x 100 mm

Interior with grommets

Interior

Side

Rear

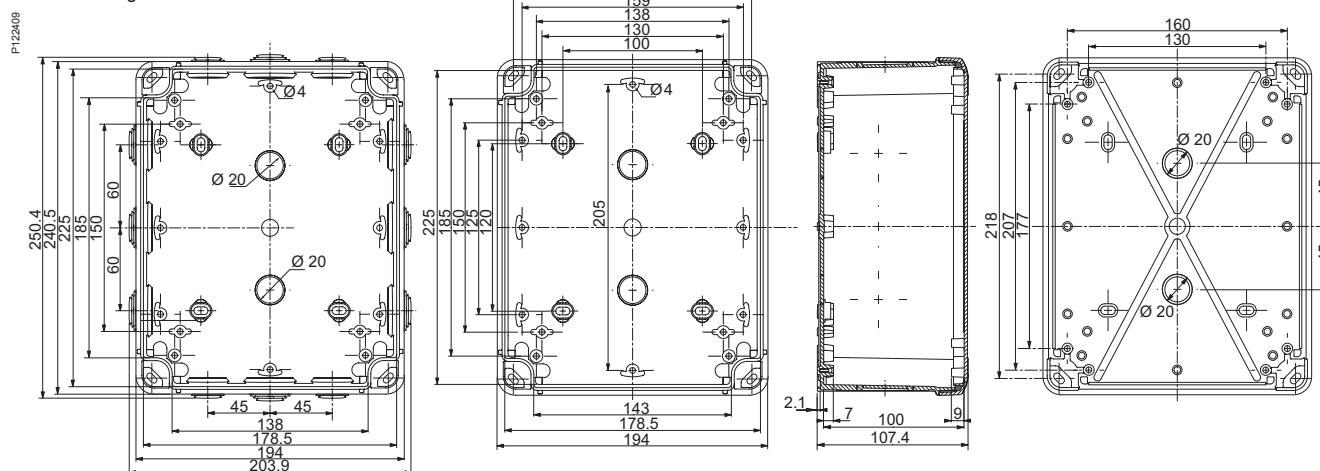



Surface mounted boxes

# Mureva boxes

## Dimensions

### Boîtes 275 x 225 x 120 mm

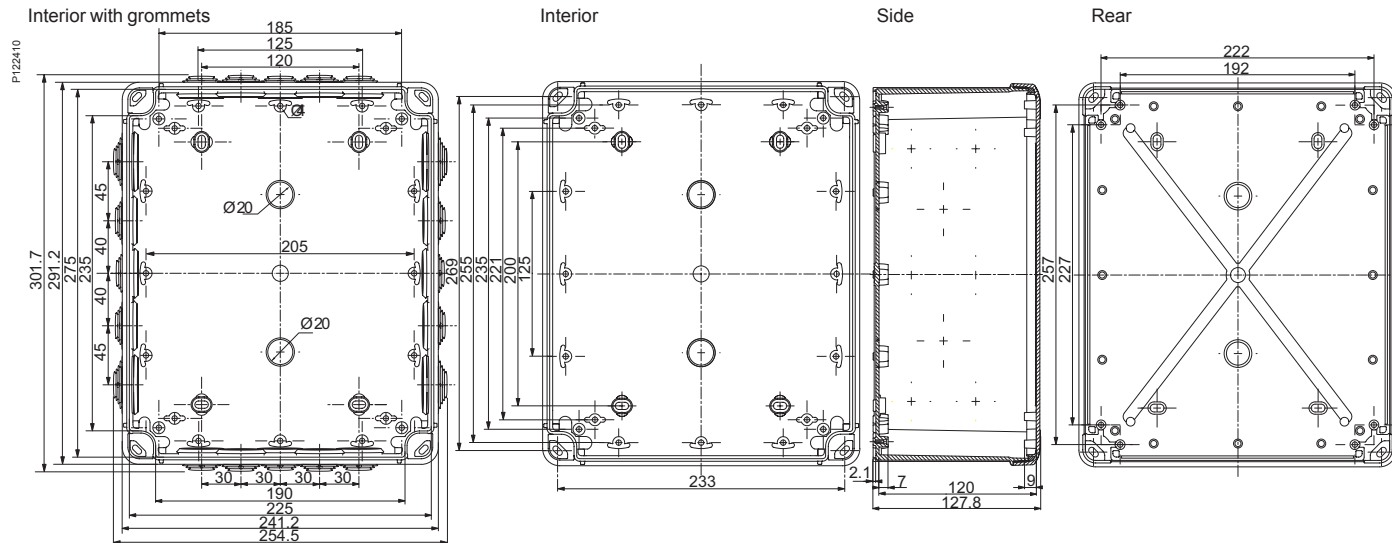

### Boîtes 325 x 275 x 120 mm

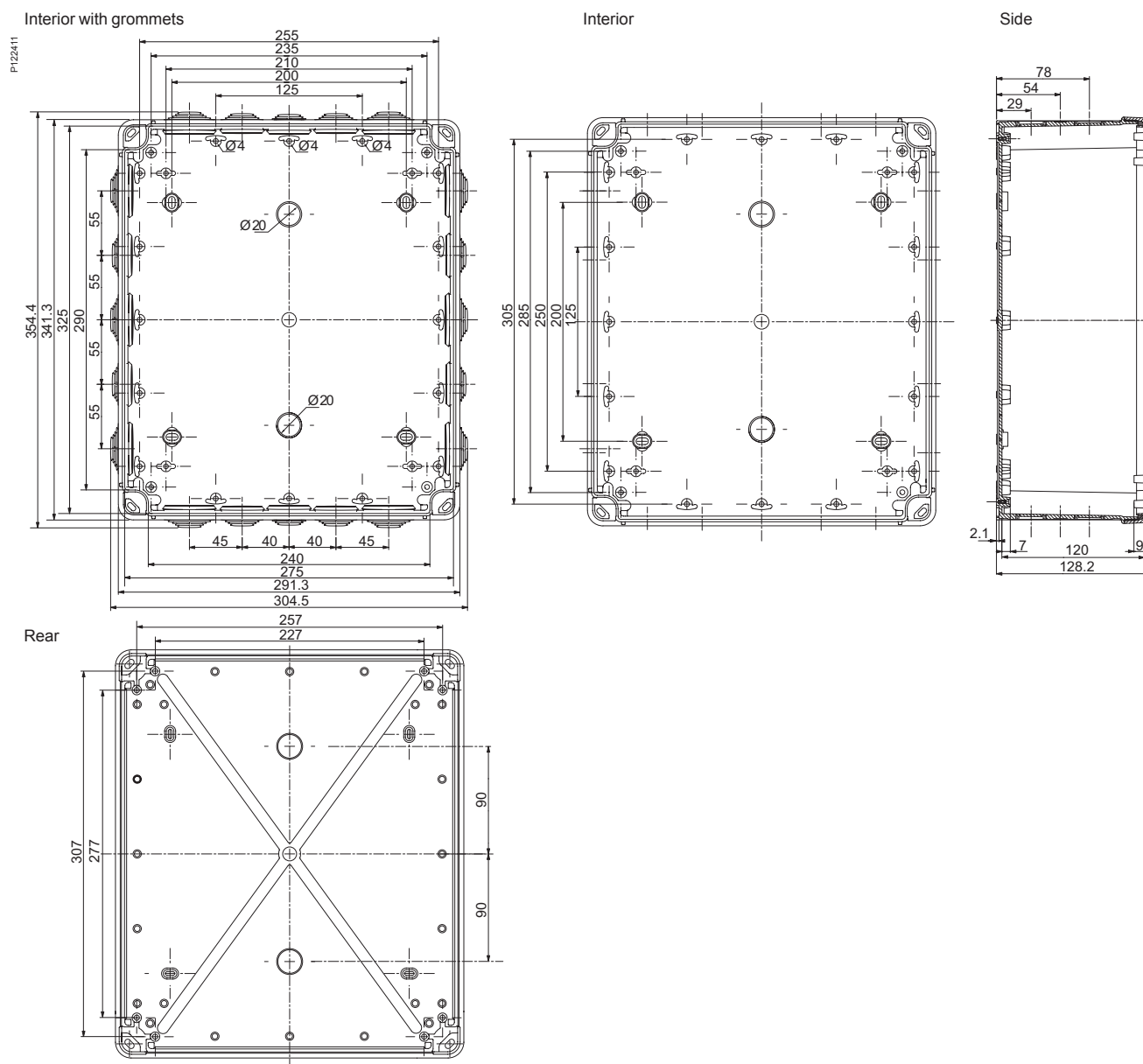

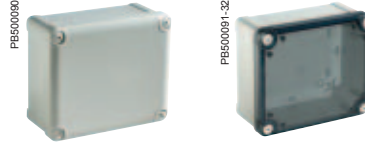

Overall external dimensions			Overall internal dimensions			Body	Cover	Minor pack.	Cover screw	Universal boxes with IP66			
(mm)			(mm)			(mm)	(mm)			ABS IP66 IK07		PC-UL IP66 IK08	
Height	Width	Depth	Height	Width	Depth					Opaque cover	Transparent cover	Opaque cover	Transparent cover
74	74	54	65	65	47	37	10	5	Metal	NSYTBS775	-	NSYTBP775	-
89	89	54	80	80	47	37	10	5	Metal	NSYTBS885	-	NSYTBP885	-
116	74	62	105	65	55	45	10	5	Metal	NSYTBS1176	-	NSYTBP1176	-
		94	105	65	85	45	40	3	Metal	NSYTBS1179H	-	-	-
	116	62	105	105	55	45	10	5	Plastic	NSYTBS11116	-	NSYTBP11116	-
138	93	133	105	105	125	45	80	2	Plastic	NSYTBS111113H	-	-	-
		72	125	80	65	45	20	2	Plastic	NSYTBS1397	NSYTBS1397T	NSYTBP1397	NSYTBP1397T
		164	121	87	150	105	80	60	20	2	Plastic	NSYTBS16128	NSYTBS16128T
192	121	87	175	105	80	60	20	2	Plastic	NSYTBS19128	NSYTBS19128T	NSYTBP19128	NSYTBP19128T
		105	175	105	100	60	40	2	Plastic	NSYTBS191210H	NSYTBS191210HT	NSYTBP191210H	NSYTBP191210HT
		164	87	175	150	80	60	20	1	Plastic	NSYTBS19168	NSYTBS19168T	NSYTBP19168
241	194	105	175	150	100	60	40	1	Plastic	NSYTBS191610H	NSYTBS191610HT	NSYTBP191610H	NSYTBP191610HT
		87	225	175	80	60	20	1	Plastic	NSYTBS24198	NSYTBS24198T	NSYTBP24198	NSYTBP24198T
		107	225	175	100	80	20	1	Plastic	NSYTBS241910	NSYTBS241910T	NSYTBP241910	NSYTBP241910T
		107	225	175	100	60	40	1	Plastic	NSYTBS241910H	NSYTBS241910HT	NSYTBP241910H	NSYTBP241910HT
291	241	127	225	175	120	80	40	1	Plastic	NSYTBS241912H	NSYTBS241912HT	NSYTBP241912H	NSYTBP241912HT
		88	275	225	80	60	20	1	Plastic	NSYTBS29248	NSYTBS29248T	NSYTBP29248	NSYTBP29248T
		128	275	225	120	100	20	1	Plastic	NSYTBS292412	NSYTBS292412T	NSYTBP292412	NSYTBP292412T
		128	275	225	120	60	60	1	Plastic	NSYTBS292412H	NSYTBS292412HT	NSYTBP292412H	NSYTBP292412HT
341	291	168	275	225	160	100	60	1	Plastic	NSYTBS292416H	NSYTBS292416HT	NSYTBP292416H	NSYTBP292416HT
		128	325	275	120	100	20	1	Plastic	NSYTBS342912	NSYTBS342912T	NSYTBP342912	NSYTBP342912T
		168	325	275	160	100	60	1	Plastic	NSYTBS342916H	NSYTBS342916HT	NSYTBP342916H	NSYTBP342916HT



# Thalassa boxes

## Selection guide



Overall external dimensions (mm)			Overall internal dimensions (mm)			Body (mm)	Cover (mm)	Minor pack.	Boxes equipped with IP54 ABS buttons		ABS button boxes, to be equipped			
Height	Width	Depth	Height	Width	Depth				Function	References	No. of holes	Cover	References	
74	74	83	-	-	-	-	-	1	Emergency switching off	XALEK1702 (1)	-	-	-	
116	74	62	105	65	55	45	10	5	-	-	2	Grey	XALE2	
		62	105	65	55	45	10	5	-	-	3	Grey	XALE3	
		75	-	-	-	-	-	-	1	Start / stop	XALE2141	-	-	-
		75	-	-	-	-	-	-	1	Up / down / stop	XALE3255	-	-	-

(1) Ref. XALEK1702 houses an emergency switching off palm button with mechanical locking according to standards IEC 60364-5-53 and 60947-5-5.

### Button description

- Emergency switching off function with a red, Ø 40 mm, "turn to unlock" palm button
- Start / Stop function with 2 push buttons
- Up / Down / Stop function with 3 push buttons
- Technical features of the switches:
  - "NC" switch with positive opening manoeuvre according to IEC 60947-5-1 appendix K
  - mechanical durability of the emergency switch: 0.1 million cycles
  - mechanical durability of the "NC" and "NO" switches: 5 million cycles
  - protection against short circuits: 10 A

Function	Type			Type of push
	"NO"	"NC"	"C / O"	
Emergency switching off	1	1	-	Latching, red
Start/stop				
Start	1	-	-	Flush, green
Stop	-	1	-	Projecting, red
Up / down / stop				
Up	-	-	1	Flush, black
Down	-	-	1	Flush, white
Stop	-	1	-	Projecting, red



Characteristics	Universal boxes with IP66	Equipped button boxes, in ABS with IP54	ABS boxes for buttons, to be equipped
	<ul style="list-style-type: none"> <li>■ Boxes that can be coupled (exactly the same dimensions) with kit ref. <b>13934</b></li> <li>■ Locks from box size of 116 x 116 x 62 mm:                             <ul style="list-style-type: none"> <li><input type="checkbox"/> cover locking by 4 plastic captive screws with coarse thread outside the sealed area</li> <li><input type="checkbox"/> plumbable lock</li> </ul> </li> <li>■ Locks from box size of 138 x 93 x 72 mm: the standard screws (flat screwdriver) can be replaced with other standardised screws (<a href="#">page 28</a>)</li> <li>■ The 4 "legs" of the cover ensure its robustness and perfect support during customisation operations</li> <li>■ Adaptable hinges on all the 20- and 40-mm covers (<a href="#">page 30</a>)</li> </ul>		
Material	<ul style="list-style-type: none"> <li>■ <b>ABS boxes:</b> <ul style="list-style-type: none"> <li><input type="checkbox"/> glow wire resistance: 650°C according to IEC 60695-2-11</li> <li><input type="checkbox"/> usage temperature: -25°C...+60°C</li> <li><input type="checkbox"/> installation temperature: -15 C...+40°C</li> </ul> </li> <li>■ <b>Polycarbonate boxes:</b> <ul style="list-style-type: none"> <li><input type="checkbox"/> glow wire resistance: 960°C</li> <li><input type="checkbox"/> usage temperature: -25°C...+80°C</li> <li><input type="checkbox"/> installation temperature: -15°C...+60°C</li> </ul> </li> </ul>	<ul style="list-style-type: none"> <li>■ <b>ABS boxes:</b> <ul style="list-style-type: none"> <li><input type="checkbox"/> glow wire resistance: 650°C according to IEC 60695-2-11</li> <li><input type="checkbox"/> usage temperature: -25°C...+60°C</li> <li><input type="checkbox"/> installation temperature: -15 C...+40°C</li> </ul> </li> </ul>	
Colour	<ul style="list-style-type: none"> <li>■ Body: RAL 7035 grey</li> <li>■ Cover: RAL 7035 grey or tinted transparent</li> </ul>		
Ingress protection rating	IP66	IP54	-
Mechanical protection rating	<ul style="list-style-type: none"> <li>■ <b>ABS:</b> IK07 (2J) according to IEC 62262</li> <li>■ <b>Polycarbonate:</b> IK08 (2J) according to IEC 62262</li> </ul>	<ul style="list-style-type: none"> <li>■ <b>ABS:</b> IK07 (2J) according to IEC 62262</li> </ul>	
Standards	IEC 62208		
Certifications	<ul style="list-style-type: none"> <li>■ IEC 62208 certified by TÜV</li> <li>■ SEMKO, DEMKO</li> <li>■ UL 508A: polycarbonate range</li> <li>■ Product Environmental Profile</li> <li>■ NEMA 4.4X according to NEMA 250</li> <li>■ Class II according to IEC 61140</li> <li>■ Self-extinguishing: UL 94-V0</li> </ul>	<ul style="list-style-type: none"> <li>■ IEC 62208 certified by TÜV</li> <li>■ SEMKO, DEMKO</li> <li>■ UL 508A: polycarbonate range</li> <li>■ Product Environmental Profile</li> <li>■ NEMA 4.4X according to NEMA 250</li> <li>■ Class II according to IEC 61140</li> </ul>	
Installation	<p><b>Fixing the box</b></p> <ul style="list-style-type: none"> <li>■ Outside the sealed sensitive volume by the 4 chimneys in the corners from box size of 138 x 93 x 72 mm</li> <li>■ Through the rear of the box by 2 or 4 elongated holes to be perforated</li> <li>■ With fixing lugs from box size of 116 x 116 x 62 mm (ref. <b>NSYAEFTB</b>)</li> </ul> <p><b>Outdoor installation:</b> compliant with IEC 62208 regarding type tests specified in §9.12 (resistance to ultra-violet (UV) radiation) and §9.13 (resistance to corrosion). It is always advisable to install a canopy to avoid water stagnation on the upper part of the enclosure</p> <p><b>Equipment installation</b></p> <ul style="list-style-type: none"> <li>■ Studs for fixing the equipment in the body and the cover of the box by means of a Ø 4-mm self-tapping screw (ref. <b>NSYAMFSTB</b>, screw Ø 4 x 10 mm with Pozidriv and slotted head)</li> <li>■ Option of installing rails, plates (<a href="#">page 31</a>) or other types of supports (card, etc.)</li> <li>■ Spacers and stand-offs to be installed on the studs, for adjusting the height of the equipment</li> </ul>		
Other characteristics	<ul style="list-style-type: none"> <li>■ Thermal dissipation:                             <ul style="list-style-type: none"> <li><input type="checkbox"/> use a suitable calculation method according to IEC 60890</li> <li><input type="checkbox"/> anti-condensation valves available as an accessory, prevent the build-up of moisture inside the box</li> </ul> </li> </ul>	<ul style="list-style-type: none"> <li>■ Thermal dissipation:                             <ul style="list-style-type: none"> <li><input type="checkbox"/> use a suitable calculation method according to IEC 60890</li> <li><input type="checkbox"/> anti-condensation valves available as an accessory, prevent the build-up of moisture inside the box</li> </ul> </li> </ul>	

### Cable entries overview



Characteristics	Simple-1	Simple-2	Simple-3	Simple-4	Simple-5
	Mixed membrane entries for enclosure thickness 20/10° - 32/10° mm.	PVC adjustable cone-shaped entries for enclosure thickness 30/10° - 32/10° mm.	Quick cable entries for enclosure thickness 10/10° - 40/10° mm.	PVC adjustable cone-shaped entries for Pg tubes or for enclosure thickness 12/10° - 15/10° mm.	ISO cable gland.
Cable entry material	Soft membrane		Combined		
Cable glands to be fitted	Not applicable				
Installation possibilities	On cable gland plate or directly on enclosure				
Flexibility of the installation	Low				
Reversibility	Medium				
Ingress protection rating	IP55	IP55	IP67	IP55	IP68
Cable retention	Low	Low	Medium	Low	High
Cable diameter (mm)	From 20 to 40	From 18 to 87	From 12 to 50	From 16 to 44	From 12 to 40
Cable Installation time	Fast	Fast	Fast	Fast	Slow
Quantity of cables to be fitted for a given surface	+	+	+	+	+
Cable entries for cables with connectors	No	No	No	No	No
Cut-out dimensions (mm)	Various circular hole diameters according to cable diameter				
External dimensions (mm)	-	From Ø 25 to 98	-	From Ø 25 to 52	From Ø 15 to 46
Certificates	-	-	-	-	-
Flame resistance	750°C	-	750°C	-	750°C

**References\***

\* For details, type reference in the search engine of [www.schneider-electric.com](http://www.schneider-electric.com)

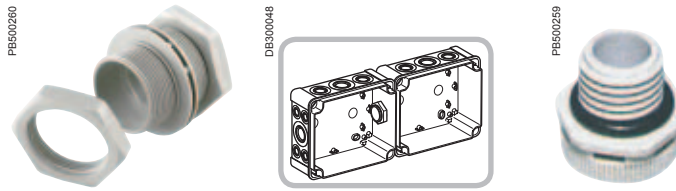

Characteristics		Coupling kit	Sealed anti-condensation valve		
		The coupling kit allows you to join several boxes with dimensions from 138 x 93 mm	Controls the pressure to avoid condensation following an internal temperature increase <b>Applications</b> Protection of equipment for luminaires, industrial control, transportation, pumps, etc		
Material		Polystyrene 650°	PA6-V2, acrylic co-polymer membrane, water and oil repellent		
Ingress protection rating		IP66	IP68		
Installation		The kit is installed by drilling a hole with Ø 32 mm in the boxes to be coupled	The valve is installed by drilling a hole with Ø 12 mm in the box		
Usage temperature		-	-40...+105°C		
Supply		The kit consists of 2 linking parts, nuts and seals	10 valves, nuts and seals		
Drill Ø	Minor pack.	Reference	Permeability (1)	Pressure difference (2)	References
32 mm	1	13934	-	-	-
M12	10	-	16 litres/h	ΔP < 1 bar	NSYCAG12LPH1
M12	10	-	120 litres/h	ΔP < 0.1 bar	NSYCAG12LPH2

(1) Air flow under ΔP = 0.7 bar.  
(2) Condition for IP68.

### Cover accessories

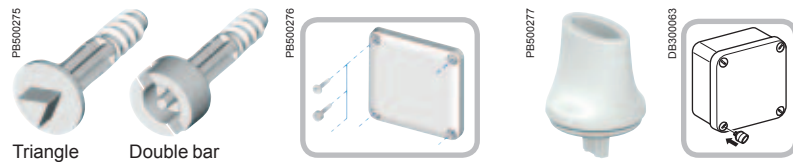

Characteristics			Set of 4 shape screws			Pack of 4 handles		
			<ul style="list-style-type: none"> <li>The Thalassa boxes are delivered as standard with slotted-head screws for flat screwdrivers from 4 to 5.5 mm</li> <li>With box sizes from 138 x 93 x 72 mm, these screws can be replaced for screws with different standardised heads, to comply with most cases</li> <li>After removing the standard screw, simply position the new screw by pressing on it</li> <li>The adapter clips (intermediate parts for tightening the cover on the body of the box) are the same as those for the standard screws. They are not delivered with the shape screws (see drawing on <a href="#">page 30</a>)</li> <li>A single key for opening the boxes as well as the other enclosures of your installation</li> </ul>			<ul style="list-style-type: none"> <li>The handle (or thumbwheel) allows the screws to be handled without any tools. It is ideally associated with a box equipped with hinges</li> <li>It snaps onto the head of the standard plastic screw</li> </ul>		
Type	Minor pack.		Height of the lid (mm)					
			20	40	60			
Triangle	6.5 mm	1	NSYAEDST620TB (1)	-	-	-		
	8 mm	1	NSYAEDST820TB	-	-	-		
Double bar	3 mm	1	NSYAEDSB320TB	-	-	-		
	5 mm	1	NSYAEDSB520TB	-	-	-		
Spare standard plastic screw		1	NSYAEDS20TB	NSYAEDS40TB	NSYAEDS60TB	-		
Pack of 4 handles		1	-	-	-	NSYAEDKTB		

(1) CNOMO.

### Terminal blocks

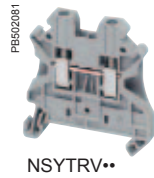

NSYTRV\*\*

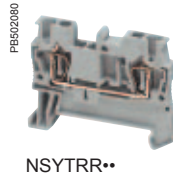

NSYTRR\*\*

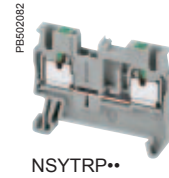

NSYTRP\*\*

Characteristics		DIN rail terminal blocks								
		<ul style="list-style-type: none"> <li>The new Linergy TR terminal blocks have 3 types of connections: screw, spring or "push-in" and they can be mounted on a DIN rail</li> <li>Connection capacity from 1.5 mm<sup>2</sup> up to 150 mm<sup>2</sup></li> <li>Available in grey, blue, orange, red, green, black or white color</li> </ul>								
Minor pack.	50									
Type	Screw connection				Spring connection				"Push-in" connection	
	H (mm)	W (mm)	D (mm)	References	H (mm)	W (mm)	D (mm)	References	References	
Passthrough, 2.5 mm <sup>2</sup> , grey	47.5	5.2	47.7	NSYTRV22	48.5	5.2	36.5	NSYTRR22	NSYTRP22	
Passthrough, 2.5 mm <sup>2</sup> , blue	47.5	5.2	47.7	NSYTRV22BL	48.5	5.2	36.5	NSYTRR22BL	NSYTRP22BL	
Protective earth, 2.5 mm <sup>2</sup>	47.5	5.2	47.7	NSYTRV22PE	48.5	5.2	36.5	NSYTRR22PE	NSYTRP22PE	
Passthrough, 4 mm <sup>2</sup> , grey	65.4	5.2	47.7	NSYTRV44	56	6.2	36.5	NSYTRR42	NSYTRP42	
Passthrough, 4 mm <sup>2</sup> , blue	65.4	5.2	47.7	NSYTRV44BL	56	6.2	36.5	NSYTRR42BL	NSYTRP42BL	
Protective earth, 4 mm <sup>2</sup>	65.4	6.2	47.7	NSYTRV44PE	56	6.2	36.5	NSYTRR42PE	NSYTRP42PE	

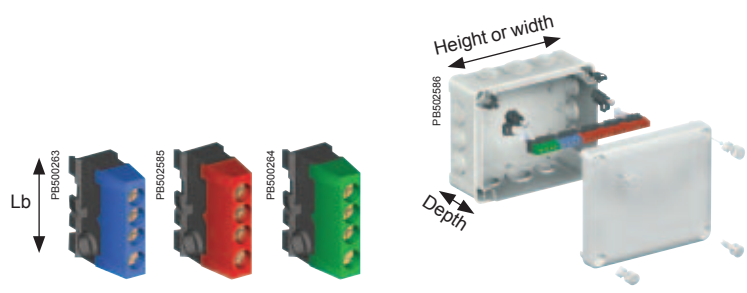
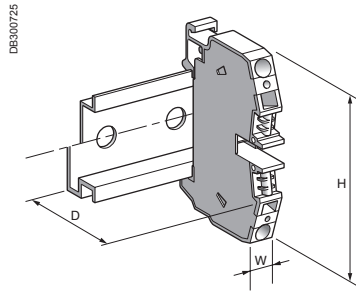

Characteristics		4-hole terminal blocks		
		<ul style="list-style-type: none"> <li>The 4-hole terminal block support bar is particularly well suited to the thermoplastic boxes</li> <li>Boxes with sizes from 192 x 116 mm can accommodate a terminal-block support bar of 12 x 2 mm</li> <li>The screwing terminal blocks are easily clipped onto this bar</li> <li>Terminal-block connection capacity: see the selection table below</li> </ul>		
Minor pack.	10	5	5	
Type	Red (live)	Blue (neutral)	Green (earth)	
4-hole terminal blocks* 2 x 10 <sup>2</sup> + 2 x 16 <sup>2</sup>	IMT34003	IMT34005	IMT34007	
Earth terminal block** 2 x 25 <sup>2</sup>	IMT34009	-	-	

\* Terminal block length (Lb): 30 mm.

\*\* The earth terminal snap fits into boxes with dimensions of less than 116 x 116 mm.

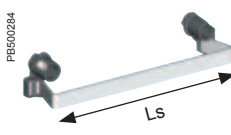

Terminal-block support bar				No. of Terminal blocks 2 x 10 <sup>2</sup> + 2 x 16 <sup>2</sup> 4 holes	Support length Ls (mm)
Height or width	Min. depth	Minor pack.	References		
192	87	1	IMT34000	4	140
241	87	1	IMT34001	6	185
291	128	1	IMT34002	8	235

Discover our complete terminal blocks range in **LVEYED213001EN**.

### Hinges

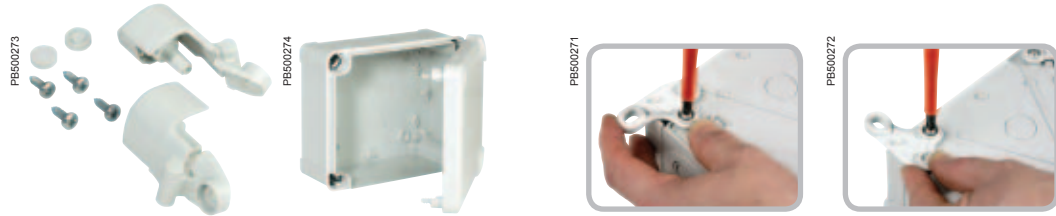

Characteristics	Set of 2 hinges	Set of 4 fixing lugs								
Ingress protection rating	IP66	IP66								
Installation	<ul style="list-style-type: none"> <li>The hinges can be adapted to all covers with a height of 20 and 40 mm with dimensions from 138 x 93 mm</li> <li>The hinge allows the lid to open fully to 200°</li> </ul>	<ul style="list-style-type: none"> <li>Plastic fixing lugs for installation on boxes with dimensions from 116 x 116 mm</li> <li>Option of vertical or horizontal installation</li> </ul>								
Maximum load	Hinged cover: 10 kg/m <sup>2</sup>	<ul style="list-style-type: none"> <li>Body: 30 kg/m<sup>2</sup></li> <li>Cover: 10 kg/m<sup>2</sup></li> </ul>								
Minor pack.	1	1								
Supply	The hinges (2 per set) are delivered with the fixings	4 lugs + screws								
	<table border="1"> <thead> <tr> <th>Height of the lid (mm)</th> <th>References</th> </tr> </thead> <tbody> <tr> <td>20</td> <td>NSYAEDH20TB</td> </tr> <tr> <td>40</td> <td>NSYAEDH40TB</td> </tr> </tbody> </table>	Height of the lid (mm)	References	20	NSYAEDH20TB	40	NSYAEDH40TB	<table border="1"> <thead> <tr> <th>Reference</th> </tr> </thead> <tbody> <tr> <td>NSYAEFTB</td> </tr> </tbody> </table>	Reference	NSYAEFTB
Height of the lid (mm)	References									
20	NSYAEDH20TB									
40	NSYAEDH40TB									
Reference										
NSYAEFTB										

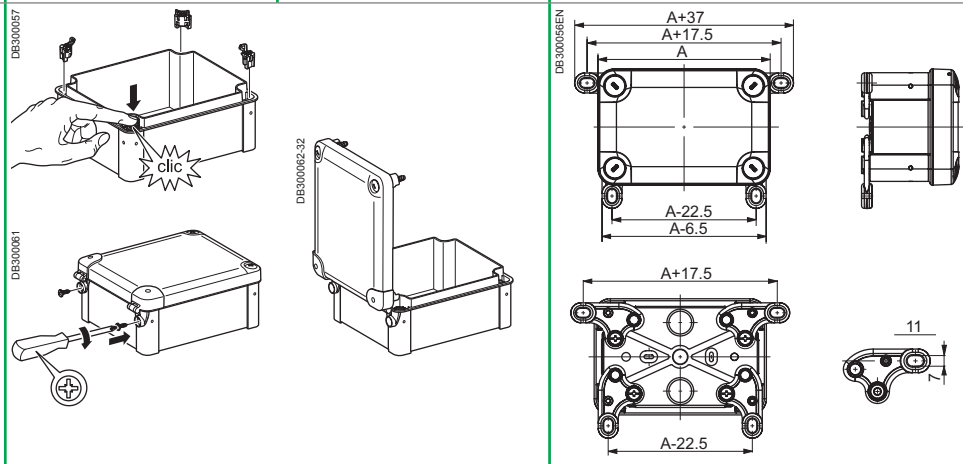

### Installation accessories

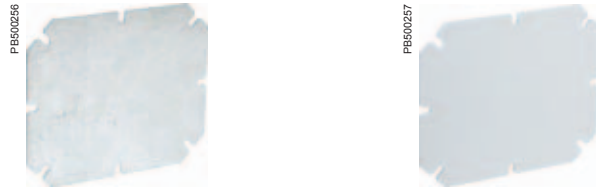

Characteristics					Mounting plates	
					Mounting plates made to adapt to all usage scenarios	
Material					Galvanised-steel	Insulating polyester plate reinforced with fibreglass, halogen-free: glow wire resistance 750°C
Thickness					15/10° mm	25/10° mm
Installation					<ul style="list-style-type: none"> <li>■ Fixing by means of Ø 4-mm self-tapping screws, Pozidrive and slotted head, ref. <b>NSYAMFSTB</b></li> <li>■ To raise the plate, use the stand-offs ref. <b>NSYAMFET154TB</b>, <b>NSYAMFET204TB</b>, <b>NSYAMFET304TB</b> and the screw <b>NSYAMFESTB</b></li> <li>■ To stack several mounting plates, use the spacers, ref. <b>NSYAMFEP154TB</b>, <b>NSYAMFEP204TB</b>, <b>NSYAMFEP304TB</b> and the screw <b>NSYAMFESTB</b></li> </ul>	
Supply					Plates supplied without screws	
Box (mm)		Dimensions (mm)		Minor pack.	References	
Height	Width	A	B			
192	164	168.5	140	1	<b>NSYAMP1916TB</b>	<b>NSYAMPA1916TB</b>
241	194	215	168.5	1	<b>NSYAMP2419TB</b>	<b>NSYAMPA2419TB</b>
291	241	265	215	1	<b>NSYAMP2924TB</b>	<b>NSYAMPA2924TB</b>
341	291	315	265	1	<b>NSYAMP3429TB</b>	<b>NSYAMPA3429TB</b>
Accessories					Pack of 100 screws	
Ø 4 x 10 mm					1	<b>NSYAMFSTB</b> <b>NSYAMFSTB</b>



### Installation accessories

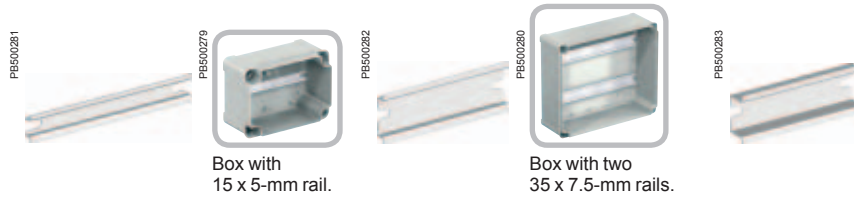

Characteristics	Rails					
	Symmetric DIN rails ■ A 15 x 5-mm rail is provided for the compact terminal blocks ■ To raise the rail, use stand-offs ref. <b>NSYAMFET154TB</b> , <b>NSYAMFET204TB</b> , <b>NSYAMFET304TB</b> and the screw <b>NSYAMFESTB</b>					
Installation	Fixing of the rails with Ø 4-mm self-tapping screws, (not included), Pozidrive and slotted head, ref. <b>NSYAMFSTB</b>					
Supply	Supplied without screws (except for the 15 x 5 mm rails)					
For boxes with height or width (mm)	15 x 5 mm		35 x 7.5 mm		35 x 15 mm	
	Minor pack.	References	Minor pack.	References	Minor pack.	References
105	10	<b>NSYAMRD11155TB</b>	10	<b>NSYAMRD11357TB</b>	-	-
150	10	<b>NSYAMRD16155TB</b>	10	<b>NSYAMRD16357TB</b>	-	-
175	10	<b>NSYAMRD19155TB</b>	10	<b>NSYAMRD19357TB</b>	-	-
225	10	<b>NSYAMRD24155TB</b>	10	<b>NSYAMRD24357TB</b>	10	<b>NSYAMRD243515TB</b>
275	10	<b>NSYAMRD29155TB</b>	10	<b>NSYAMRD29357TB</b>	10	<b>NSYAMRD293515TB</b>
325	10	<b>NSYAMRD34155TB</b>	10	<b>NSYAMRD34357TB</b>	10	<b>NSYAMRD343515TB</b>

Accessories	Pack of 100 screws
Ø 4 x 10 mm	<b>NSYAMFSTB</b>

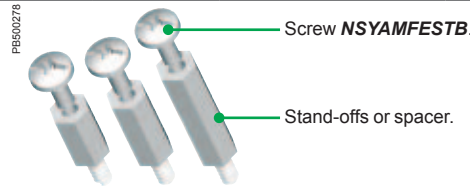

Characteristics	Stand-offs	Spacers
	Stand-offs consisting of a Ø 4-mm self-tapping thread at one end (for direct screwing into the rivets of the box) and an M4 tapping on the other end, for direct installation of a card with an M4 screw, ref. <b>NSYAMFESTB</b> , or of a spacer	Spacer for installation on the stand-offs M4 thread and tapping
Material	Steel	Steel
Supply	Set of four M4 self-tapping stand-offs	Set of four M4 spacers
Height (mm)	Minor pack.	References
15	1	<b>NSYAMFET154TB</b>
20	1	<b>NSYAMFET204TB</b>
30	1	<b>NSYAMFET304TB</b>
		<b>NSYAMFEP154TB</b>
		<b>NSYAMFEP204TB</b>
		<b>NSYAMFEP304TB</b>

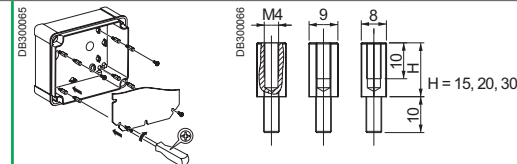

Accessories	Screw for stand-offs and spacers
	M4 x 10 mm screw for fixing cards on the spacers and stand-offs ■ The plate always at the right level ■ A single Ø 4-mm screw for fixing any element
Supply	Batch of 50 screws
Minor pack.	References
1	<b>NSYAMFESTB</b>

### Box of 74 x 74 x 54 mm (external dimensions) NSYTB...775

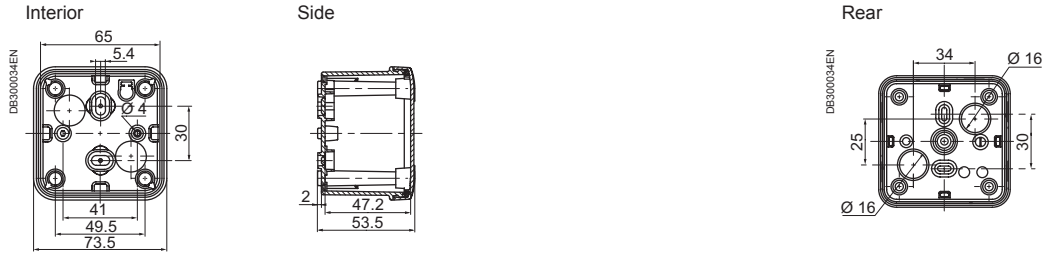

### Box of 89 x 89 x 54 mm (external dimensions) NSYTB...885

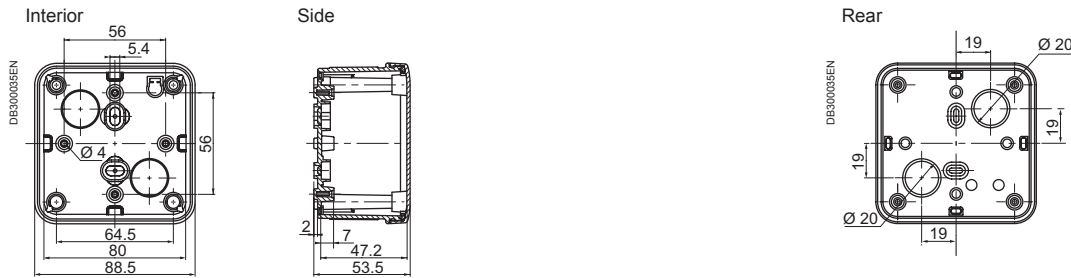

### Box of 116 x 74 x 62 or 94 mm (external dimensions) NSYTB...1176 or NSYTB...1179

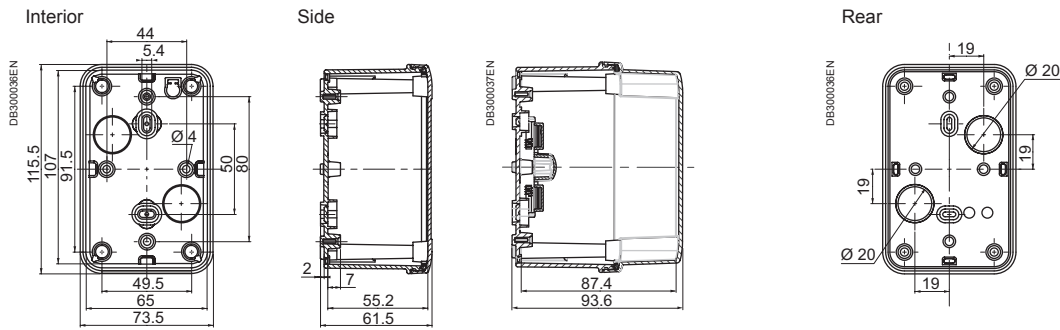

### Box of 116 x 116 x 62 or 133 mm (external dimensions) NSYTB...11116 or NSYTB...11113

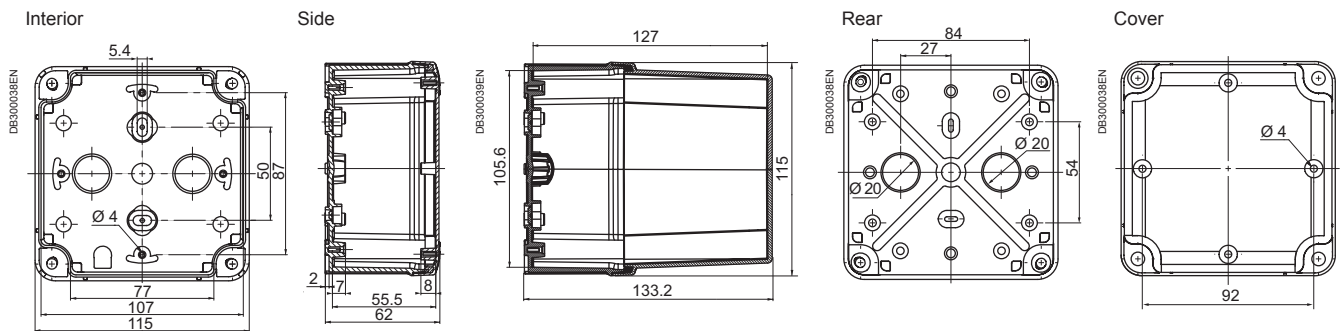

### Box of 138 x 93 x 72 mm (external dimensions) NSYTB...1397

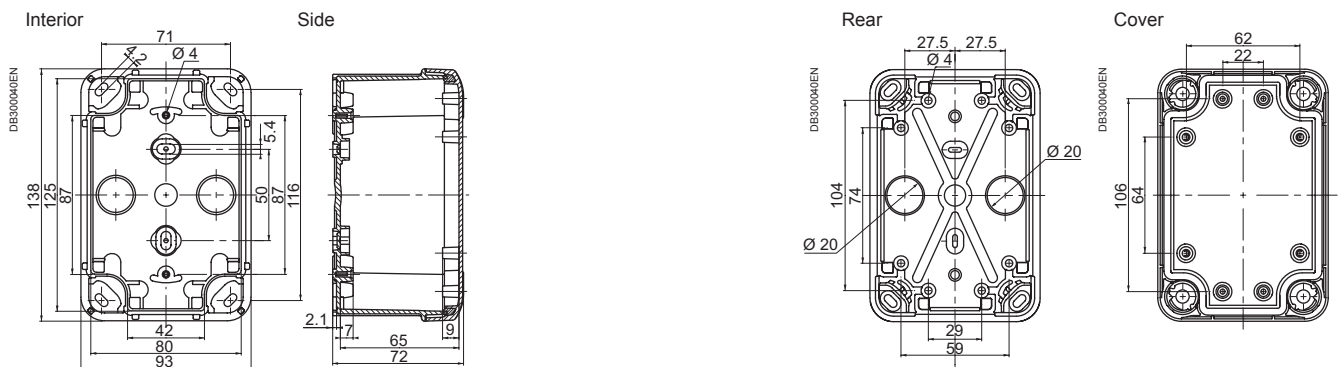

### Box of 164 x 121 x 87 mm (external dimensions) NSYTB...16128

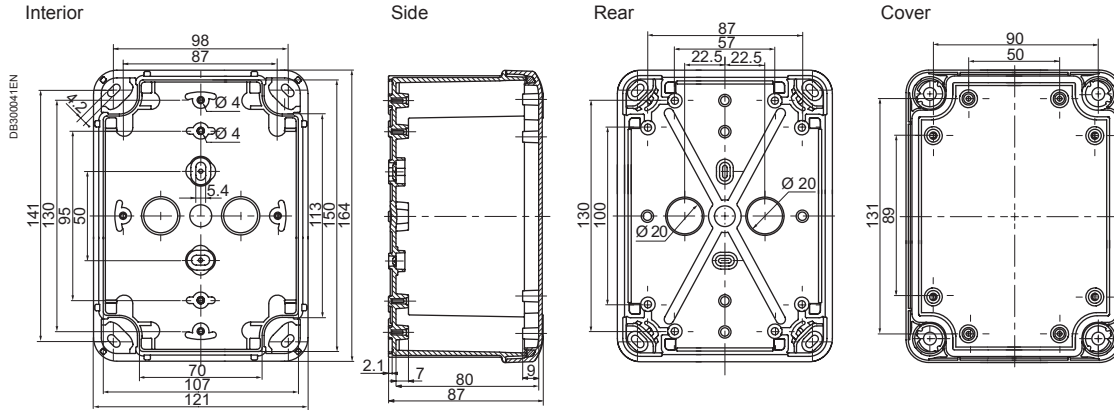

### Box of 192 x 121 x 87 or 105 mm (external dimensions) NSYTB...19128 or NSYTB...191210

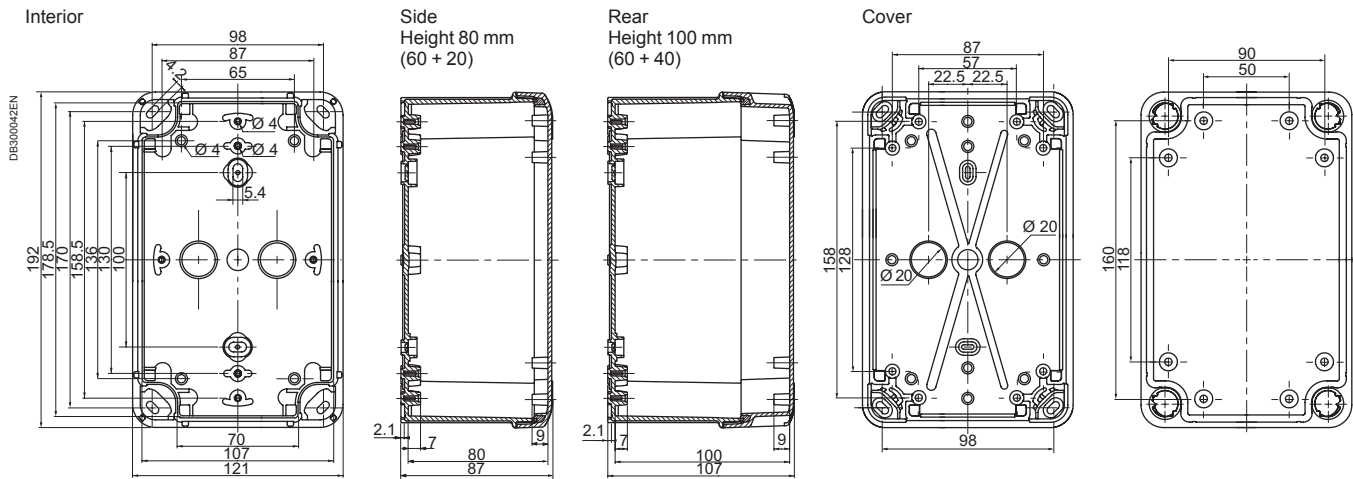

### Box of 192 x 164 x 87 or 105 mm (external dimensions) NSYTB...19168 or NSYTB...191610

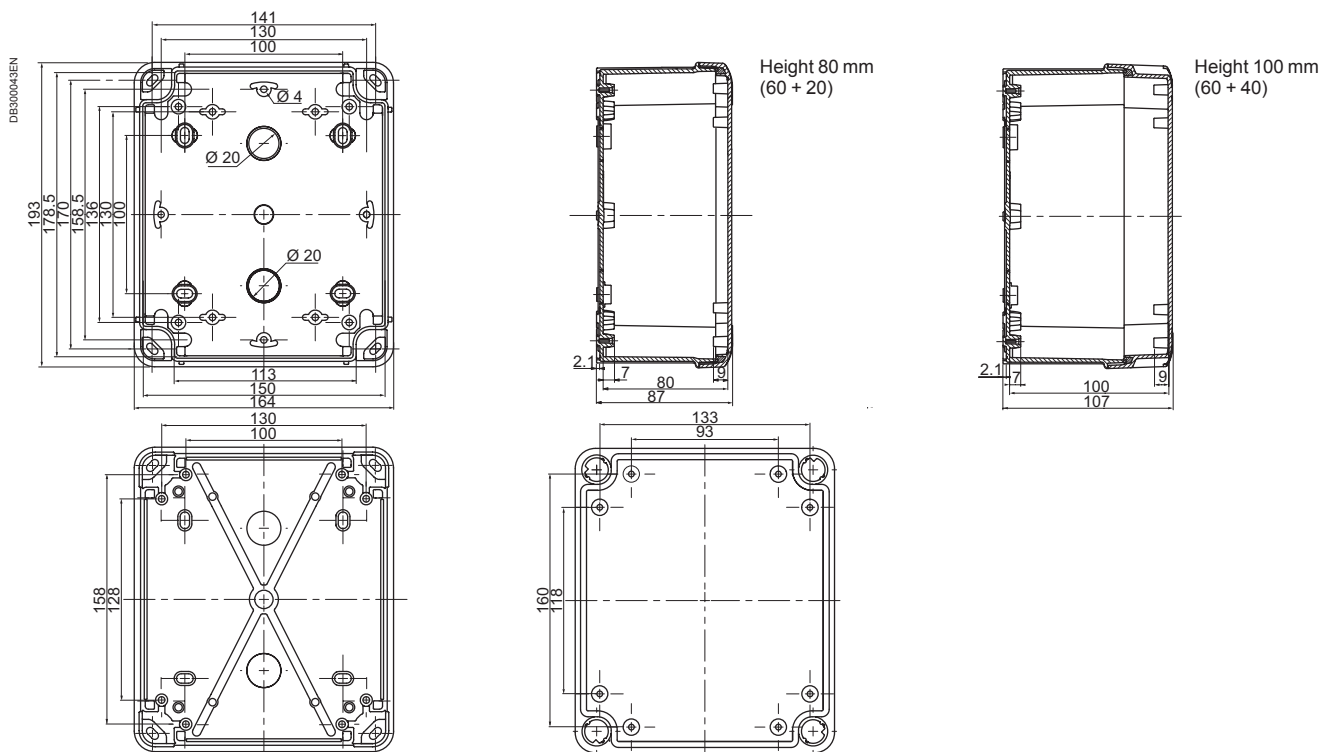

**Box of 241 x 194 x 87, 107 or 127 mm (external dimensions) NSYTB...24198, NSYTB...241910 or NSYTB...241912**

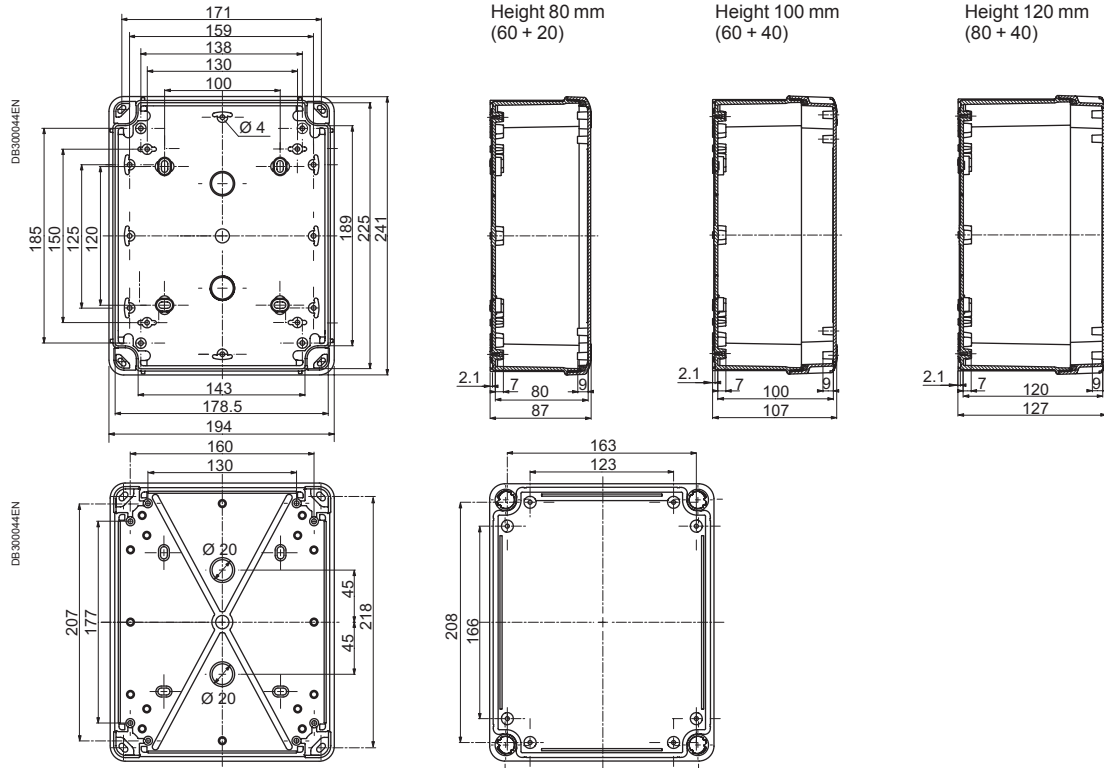

**Box of 291 x 241 x 88, 128 or 168 mm (external dimensions) NSYTB...29248, NSYTB...292412 or NSYTB...292416**

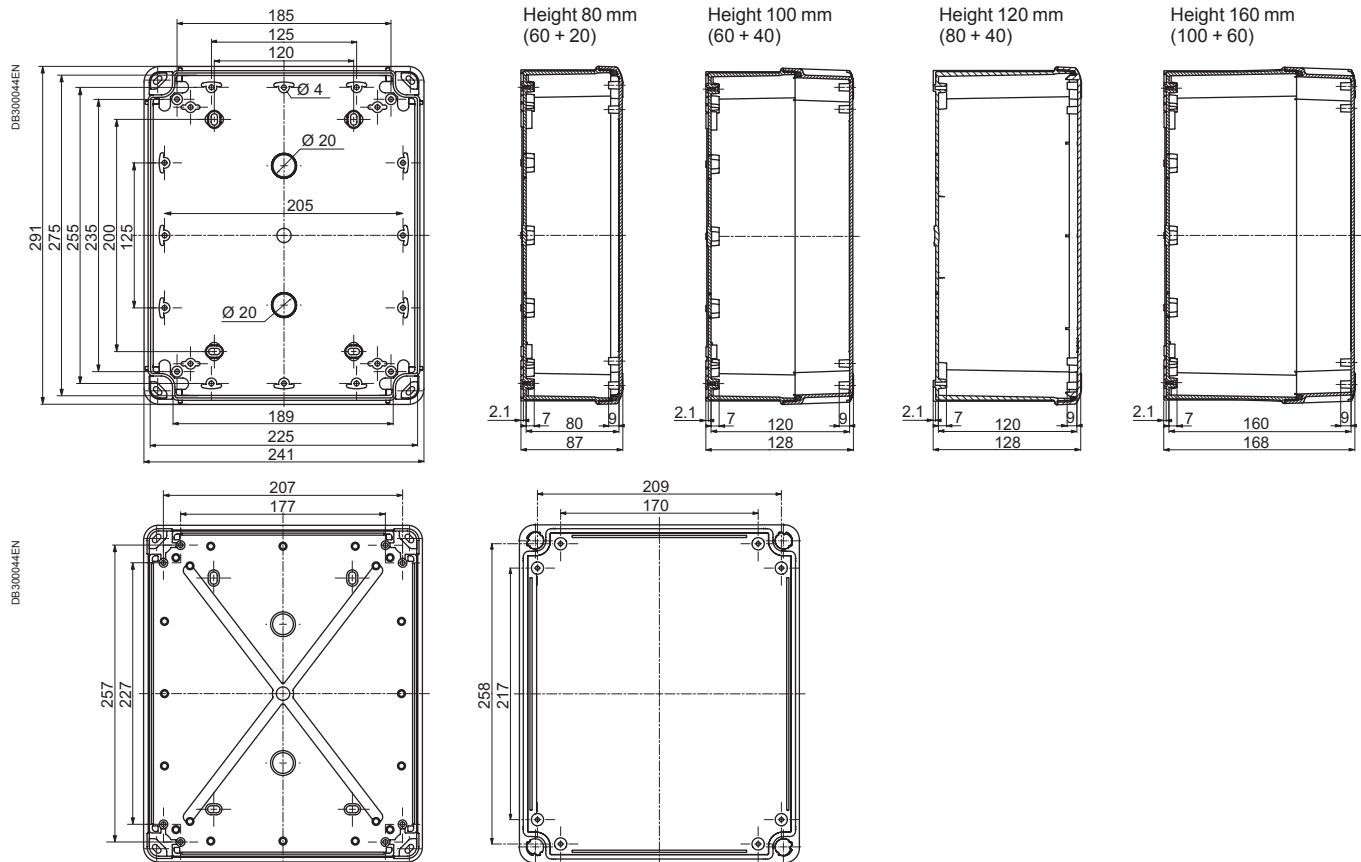



# Surface mounted boxes

# Thalassa boxes Dimensions

**Box of 341 x 291 x 128 or 168 mm (external dimensions) NSYTB...342912 or NSYTB...342916**

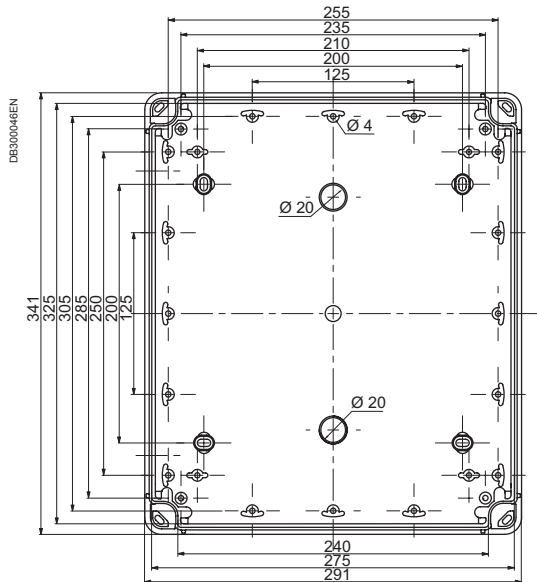

Height 120 mm  
(80 + 40)

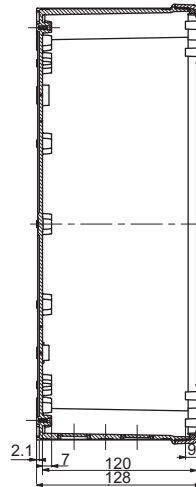

Height 160 mm  
(100 + 60)

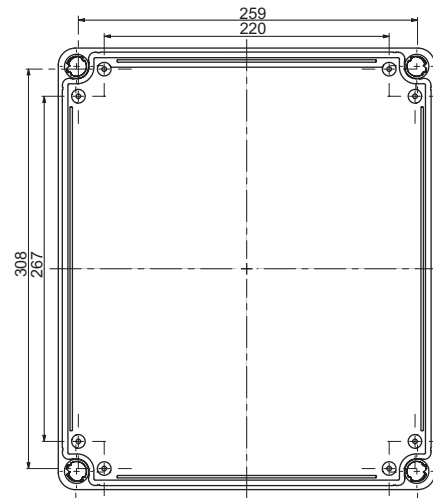
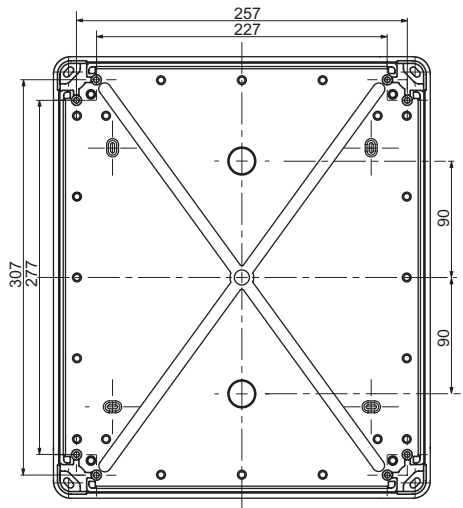
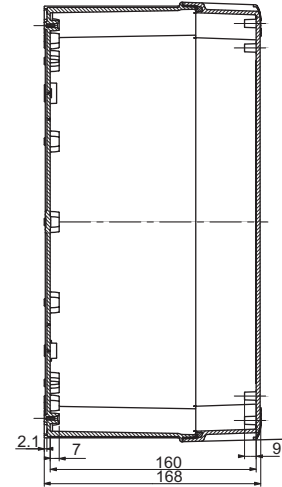

# Properties of the plastic materials

## Mechanical, electrical, physical and fire-resistance properties

Plastic materials generally used to manufacture our products:

- ABS
- Polycarbonate
- PVC (polyvinyl chloride)
- Bayblend® = PC + ABS
- Polyester reinforced with fibreglass
- Altuglas
- Polypropylene
- Polystyrene
- Polyamide 6 and 12
- SBS.

Specifications	Standards	Units	ABS	Polycarbonate	PVC	Bayblend®	Polyester	SBS
<b>Mechanical properties</b>								
Tensile strength	ISO 257	MPa	44	> 65	45	35	85	5
Tensile strain	ISO 527	%	12	> 110	120 to 150	40	0	600
Impact resistance	ISO 179	kJ/m <sup>2</sup>	125	No breakage	25	No breakage	60	No breakage
Notching resistance	ISO 179	kJ/m <sup>2</sup>	19	25	20	25	50	-
<b>Electrical properties</b>								
Stress point	IEC 60112	-	-	250-300	> 600	> 550	> 600	-
Surface strength	IEC 60093	ohm	1015	> 1015	> 1013	> 1014	≥1012	> 1013
Dielectric strength	IEC 60243	kV/mm	16.5	> 30	30	24	18-20	20
Specific resistivity	IEC 60093	ohm <sup>3</sup> cm	1015	> 1016	≥ 1015	1016	≥ 1012	> 1016
<b>Physical properties</b>								
Softening temperature (Vicat B)	ISO 306	°C	95	145-150	79-80	115	(1)	80
Temperature resistance	-	°C	-40...+90	-50...+125	-20...+65	-35...+90	-50...+150	-40...+120
Water absorption	ISO 62	%	0.2 - 0.45	0.15	< 0.1	0.2	0.2	-
Specific weight	ISO 1183	kg/dm <sup>3</sup>	1.04	1.21	1.4	1.12	1.85	0.3 in 24 h
<b>Fire resistance</b>								
Oxygen index	ISO 4589	%	19	26	45-50	22	24.4	18
Glow wire resistance, 2 mm	IEC 60695-2	°C	650	960	960	750	960	750° (1.5 mm)
Glow wire resistance, 3 mm	IEC 60695-2	°C	650	960	960	750	960	NA

(1) No softening of the polyester.

Specifications	Standards	Units	Altuglas	Polypropylene	Polystyrene	Polyamide 6	Polyamide 12
<b>Mechanical properties</b>							
Tensile strength	ISO 257	MPa	30	35	24	40	30
Tensile strain	ISO 527	%	5	400	36	200	300
Impact resistance	ISO 179	kJ/m <sup>2</sup>	20	20	63	No breakage	No breakage
Notching resistance	ISO 179	kJ/m <sup>2</sup>	3	5	50	31.2	15
<b>Electrical properties</b>							
Stress point	IEC 60112	-	-	-	KB175	KB175	KB180
Surface strength	IEC 60093	ohm	≥ 1014	-	> 1013	1012	5 x 1010
Dielectric strength	IEC 60243	kV/mm	13-15	20	≤ 40	23	55
Specific resistivity	IEC 60093	ohm <sup>3</sup> cm	> 1015	> 1016	> 1015	1011	3 x 1011
<b>Physical properties</b>							
Softening temperature (Vicat B)	ISO 306	°C	120-122	75 (vicat A)	79	230	140
Temperature resistance	-	°C	-20...+80	-10...+80	-15...+60	-20...+100	-50...+125
Water absorption	ISO 62	%	< 0.5	0.1 in 24 h	0.1 in 24 h	1.6	1.5
Specific weight	ISO 1183	kg/dm <sup>3</sup>	1.18	0.91	1.06	1.14	1.03
<b>Fire resistance</b>							
Oxygen index	ISO 4589	%	18.5	18	18	24	22
Glow wire resistance, 2 mm	IEC 60695-2	°C	-	650	650	750	650
Glow wire resistance, 3 mm	IEC 60695-2	°C	960	650	650	850	650

# Properties of the plastic materials

## Resistance to chemical agents

The table shows:

- The concentration of the chemical agent in %; sat = saturation
- The resistance of the material:
  - +: Resistant
  - O: Limited resistance
  - : Not resistant.

Plastic materials generally used to manufacture our products:

- ABS
- Polycarbonate
- PVC (polyvinyl chloride)
- Bayblend® = PC + ABS
- Polyester
- Altuglas
- Polypropylene
- Polystyrene
- Polyamide 6 and 12
- SBS.

Resistance to	ABS	Poly-carbonate	PVC	Bayblend®	Polyester	Altuglas	Poly-propylene	Poly-styrene	Poly-amide 6	Poly-amide 12	SBS
Acetone	-	-	-	-	-	O	100 +	-	100 +	+	+
Hydrochloric acid	15 +	10 +	30 +	20 +	30 +	sat +	10 +	O	10 -	10 +	10 +
Citric acid		10 +	sat +	10 +	100 +	sat +	sat +	+	10 O	+	10 +
Lactic acid	80 +	10 +	90 +	10 -	100 +	20 +	90 +	O	50 O	+	sat +
Nitric acid	30 +	10 + 100 -	50 +	10 +	20 +	10 + 100 -	25/ 50	O	2 O	-	50 +
Phosphoric acid	85 +	100 +	sat +	+	100 +	10 + 95 -	sat +	O	2 O	50 +	+
Sulphuric acid	50 +	50 + 100 -	96 +	30 +	70 +	30 +	96 +	O	3 -	10 +	96 +
Alcohol	O	96 +	96 +	-	50 O	50 O	96 +	+	96 O	96 +	+
Pure aniline	O	-	100 -	-	O	-	100 +		100 O	100 O	
Benzene	+	100 -	-	+	-	O	100 O		100 +	+	-
Liquid bromine		100 -	-	-	-	-	100 -			100 -	-
Liquid chlorine		-	100 -	-	sat +	-	100 -		100 O	-	50 +
Sea water	+	100 +	100 +	+	100 +	100 +	-	100 +		100 +	sat +
Petrol	+	100 +	100 O	-	100 +	100 O	-	-	100 +	+	-
Ether	-	100 O	100 -	-	100 O	+			100 +	100 +	-
Hexane	O	+	O	O	-		100 +		100 +	100 +	-
Oil and greases	+	100 +	100 +	O	100 +	100 O	100 +	-	+	100 +	-
Aromatic hydrocarbon	O	-	-	-	-	+	-	-	-	+	-
Fuel oil	O	100 O	100 +	-	100 +	100 -	100 +		100 +	100 +	-
Naphthalene			100 O	-	100 +	100 -	100 +		100 +	100 +	
Nitrobenzene	-	-	100 -	-	-	-	100 O		-	O	-
Phenol	-	-	sat O	-	20 O	-	sat +		-	-	10 O
Mineral salts		+	+	+	+	+	+			+	+
Iodine solution		O	-	+	-	-			+		
Toluene	-	-	100 -	-	+	O	100 O	-	100 +	100 +	-
Trichloroethylene	-	-	100 -	-	-	-	100 O	-	100 -	100 O	-
Urea		sat +	sat +	+	+	+	sat +		10 +	sat +	sat O

For other chemical agents, please contact us.  
 All this information is taken from the best sources and provided for information purposes only, with no commitment on our behalf.





1

13934 ..... 18

E

ENN02290 ..... 20

ENN05001 ..... 11, 14

ENN05002 ..... 11, 14

ENN05003 ..... 11, 14

ENN05004 ..... 11, 14

ENN05005 ..... 11, 14

ENN05007 ..... 11, 14

ENN05010 ..... 11, 14

ENN05013 ..... 11, 14

ENN05017 ..... 11, 14

ENN05019 ..... 11, 14

ENN05021 ..... 11, 14

ENN05022 ..... 11, 14

ENN05023 ..... 11, 14

ENN05024 ..... 11, 14

ENN05025 ..... 11, 14

ENN05032 ..... 11, 14

ENN05044 ..... 10, 15

ENN05045 ..... 10, 15

ENN05047 ..... 10, 15

ENN05050 ..... 10, 15

ENN05053 ..... 10, 15

ENN05057 ..... 10, 15

ENN05059 ..... 10, 15

ENN05064 ..... 10, 15

ENN05065 ..... 10, 15

ENN05072 ..... 11, 14

ENN05082 ..... 10, 15

ENN05083 ..... 10, 15

ENN05084 ..... 10, 15

ENN05085 ..... 10, 15

ENN05087 ..... 10, 15

ENN05090 ..... 10, 15

ENN05093 ..... 10, 15

ENN05097 ..... 10, 15

ENN05099 ..... 10, 15

ENN05121 ..... 14

ENN05124 ..... 14

ENN05125 ..... 14

ENN05142 ..... 14

ENN05164 ..... 11, 16

ENN05165 ..... 11, 16

ENN05167 ..... 11, 16

ENN05174 ..... 10, 16

ENN05175 ..... 10, 16

ENN05177 ..... 10, 16

ENN05204 ..... 11, 14

ENN05205 ..... 11, 14

ENN05264 ..... 11, 16

ENN05265 ..... 11, 16

ENN05267 ..... 11, 16

ENN08131 ..... 18

ENN08132 ..... 18

ENN08162 ..... 18

ENN08167 ..... 18

ENN08241 ..... 19

ENN08271 ..... 20

ENN08276 ..... 20

ENN48861 ..... 18

I

IMT34000 ..... 19, 29

IMT34001 ..... 19, 29

IMT34002 ..... 19, 29

IMT34003 ..... 19, 29

IMT34005 ..... 19, 29

IMT34007 ..... 19, 29

IMT34009 ..... 19, 29

IMT36089 ..... 19

IMT36150 ..... 17

IMT36151 ..... 17

IMT36152 ..... 17

IMT36153 ..... 17

IMT36154 ..... 17

IMT36155 ..... 17

IMT36156 ..... 17

IMT36157 ..... 17

IMT36158 ..... 17

IMT36159 ..... 17

IMT36160 ..... 17

IMT36161 ..... 17

IMT36162 ..... 17

IMT36163 ..... 17

IMT36164 ..... 17

IMT36165 ..... 17

IMT36166 ..... 17

IMT36167 ..... 17

IMT36168 ..... 17

IMT36169 ..... 17

IMT36170 ..... 17

IMT36171 ..... 17

IMT36172 ..... 18

IMT36173 ..... 18

IMT36179 ..... 18

IMT36180 ..... 18

IMT36181 ..... 18

IMT36182 ..... 18

IMT36183 ..... 18

IMT36184 ..... 18

IMT36185 ..... 18

ISM71071 ..... 18

ISM71072 ..... 18

ISM71073 ..... 18

ISM71074 ..... 18

ISM71501 ..... 17

ISM71502 ..... 17

ISM71503 ..... 17

ISM71504 ..... 17

ISM71505 ..... 17

ISM71506 ..... 17

N

NSYAEDH20TB ..... 30

NSYAEDH40TB ..... 30

NSYAEDKTB ..... 28

NSYAEDS20TB ..... 28

NSYAEDS40TB ..... 28

NSYAEDS60TB ..... 28

NSYAEDSB320TB ..... 28

NSYAEDSB520TB ..... 28

NSYAEDST620TB ..... 28

NSYAEDST820TB ..... 28

NSYAEFTB ..... 18, 30

NSYAMFEP154TB ..... 32

NSYAMFEP204TB ..... 32

NSYAMFEP304TB ..... 32

NSYAMFESTB ..... 32

NSYAMFET154TB ..... 32

NSYAMFET204TB ..... 32

NSYAMFET304TB ..... 32

NSYAMFSTB ..... 31, 32

NSYAMPA1916TB ..... 31

NSYAMPA2419TB ..... 31

NSYAMPA2924TB ..... 31

NSYAMPA3429TB ..... 31

NSYAMPM1916TB ..... 31

NSYAMPM2419TB ..... 31

NSYAMPM2924TB ..... 31

NSYAMPM3429TB ..... 31

NSYAMRD11155TB ..... 20, 32

NSYAMRD11357TB ..... 20, 32

NSYAMRD16155TB ..... 20, 32

NSYAMRD16357TB ..... 20, 32

NSYAMRD19155TB ..... 20, 32

NSYAMRD19357TB ..... 20, 32

NSYAMRD24155TB ..... 20, 32

NSYAMRD24357TB ..... 20, 32

NSYAMRD29155TB ..... 20, 32

NSYAMRD29357TB ..... 20, 32

NSYAMRD34155TB ..... 20, 32

NSYAMRD34357TB ..... 20, 32

NSYAMRD243515TB ..... 32

NSYAMRD293515TB ..... 32

NSYAMRD343515TB ..... 32

NSYCAG12LPH1 ..... 28

NSYCAG12LPH2 ..... 28

NSYTBP775 ..... 24

NSYTBP885 .....	24	NSYTRR42PE .....	29
NSYTBP1176 .....	24	NSYTRV22 .....	29
NSYTBP1397 .....	24	NSYTRV22BL .....	29
NSYTBP1397T .....	24	NSYTRV22PE .....	29
NSYTBP11116 .....	24	NSYTRV44 .....	29
NSYTBP16128 .....	24	NSYTRV44BL .....	29
NSYTBP16128T .....	24	NSYTRV44PE .....	29
NSYTBP19128 .....	24		
NSYTBP19128T .....	24		
NSYTBP19168 .....	24		
NSYTBP19168T .....	24		
NSYTBP24198 .....	24		
NSYTBP24198T .....	24		
NSYTBP29248 .....	24		
NSYTBP29248T .....	24		
NSYTBP191210H .....	24		
NSYTBP191210HT .....	24		
NSYTBP191610H .....	24		
NSYTBP191610HT .....	24		
NSYTBP241910 .....	24		
NSYTBP241910H .....	24		
NSYTBP241910HT .....	24		
NSYTBP241910T .....	24		
NSYTBP241912H .....	24		
NSYTBP241912HT .....	24		
NSYTBP292412 .....	24		
NSYTBP292412H .....	24		
NSYTBP292412HT .....	24		
NSYTBP292412T .....	24		
NSYTBP292416H .....	24		
NSYTBP292416HT .....	24		
NSYTBP342912 .....	24		
NSYTBP342912T .....	24		
NSYTBP342916H .....	24		
NSYTBP342916HT .....	24		
NSYTBS775 .....	24		
NSYTBS885 .....	24		
NSYTBS1176 .....	24		
NSYTBS1179H .....	24		
NSYTBS1397 .....	24		
NSYTBS1397T .....	24		
NSYTBS11116 .....	24		
NSYTBS16128 .....	24		
NSYTBS16128T .....	24		
NSYTBS19128 .....	24		
NSYTBS19128T .....	24		
NSYTBS19168 .....	24		
NSYTBS19168T .....	24		
NSYTBS24198 .....	24		
NSYTBS24198T .....	24		
NSYTBS29248 .....	24		
NSYTBS29248T .....	24		
NSYTBS111113H .....	24		
NSYTBS191210H .....	24		
NSYTBS191210HT .....	24		
NSYTBS191610H .....	24		
NSYTBS191610HT .....	24		
NSYTBS241910 .....	24		
NSYTBS241910H .....	24		
NSYTBS241910HT .....	24		
NSYTBS241910T .....	24		
NSYTBS241912H .....	24		
NSYTBS241912HT .....	24		
NSYTBS292412 .....	24		
NSYTBS292412H .....	24		
NSYTBS292412HT .....	24		
NSYTBS292412T .....	24		
NSYTBS292416H .....	24		
NSYTBS292416HT .....	24		
NSYTBS342912 .....	24		
NSYTBS342912T .....	24		
NSYTBS342916H .....	24		
NSYTBS342916HT .....	24		
NSYTRP22 .....	29		
NSYTRP22BL .....	29		
NSYTRP22PE .....	29		
NSYTRP42 .....	29		
NSYTRP42BL .....	29		
NSYTRP42PE .....	29		
NSYTRR22 .....	29		
NSYTRR22BL .....	29		
NSYTRR22PE .....	29		
NSYTRR42 .....	29		
NSYTRR42BL .....	29		

W

WDE0000010 .....	19
------------------	----

X

XALE2 .....	25
XALE3 .....	25
XALE2141 .....	25
XALE3255 .....	25
XALEK1702 .....	25







Life Is On | **Schneider**  
Electric™

Schneider Electric Industries SAS

35, rue Joseph Monier - CS 30323  
F-92506 Rueil-Malmaison - FRANCE  
Phone: + 33 (0) 1 41 29 70 00  
Fax: + 33 (0) 1 41 29 71 00  
[www.schneider-electric.com](http://www.schneider-electric.com)

01-2016  
Document Number LSB02647EN

©2015 Schneider Electric. All Rights Reserved.  
All trademarks are owned by Schneider Electric Industries SAS or its affiliated companies.

This document has been  
printed on recycled paper 

