



Weathersafe Extreme



Installation and Operating Instructions

WEATHERSAFE
IP66
RATING

Weathersafe
Extreme

3
Year
Guarantee

IP66 Products covered by these instructions

TGVL01	One gang two way switch 10AX
TGVL02	Two gang two way switch 10AX
TGVL03	One gang bell push
TGVL05	One gang double pole switch 20A
WXT101	One gang socket switched 13A
WXT201	Two gang socket switched 13A
WXT104	One gang RCD spur
WXT204	Two gang RCD protected socket 13A (passive/latching)
WXT205	Two gang RCD protected socket 13A (active/non-latching)
WXT203	Combined timer and socket
WXT103	One gang switched fused spur 13A

General

Please note that all instructions are to be left with the customer after installation.

The Weathersafe Extreme range is manufactured from tough, durable thermoplastic, and is intended for use in an outdoor environment, or one in which the protection provided by the Weathersafe Extreme range is required.

All the products are rated IP66, for protection against water and dust. All Weathersafe Extreme products need to be fitted with waterproof cable and conduit entries to maintain their IP rating once installed.

The weather Extreme range complies with the following standards.

- IP66 rating: BS EN 60529
- Socket outlets: BS 1363
- RCD units: BS 7288
- Fused connection units: BS 1363
- Switches: BS EN 60669
- All products in the range comply with the low voltage directive LV 72/23/EEC and where relevant the EMC directive 89/336/EEC

Voltage: 230V AC 50Hz

Operating temperature range: -5° to 55°C

Installation instructions

- These products should be installed by a competent person (e.g. qualified electrician) in accordance with these instructions and in compliance with the appropriate clauses of the current edition of the IEE wiring and building regulations. Sockets should be connected via a suitable RCD device.
- Disconnect the mains electricity supply before installing.
- The Weathersafe Extreme range is designed to be mounted on a vertical flat surface, with socket outlets not more than 1 metre above the ground.
- The rear box shall be mounted on the wall using no.8 wood screws and wall plugs if necessary (see fig. 1).
- If the mounting surface is uneven use a sheet of marine ply as a base plate then fit the rear box to it.

Fig. 1
Rear Box (double)

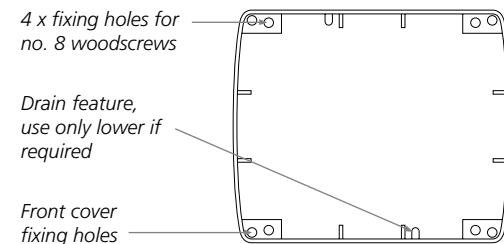

If conduit is to be used then please follow the instructions below:

- The drain feature must be drilled out using a 5mm drill if top or side entry conduit is used. Opening this drain hole will reduce the IP rating of the product. Remember – open out the lower drain feature only and only if required by conduit entry being used.
- If bottom entry conduit is used, there must be adequate drainage from the lowest point of the conduit.
- The relevant cable entry knockout should be carefully removed by scoring the groove around the knockout with a sharp knife and then tapping it out with a small hammer. A waterproof cable or conduit entry must then be fitted in its place.
- If two cable entry positions are used with metal conduit, then earth continuity between the conduits must be maintained.
- Ensure that the gasket is correctly fitted, and tighten the four screws (supplied) to fix the front cover in place (see fig. 1). Do not overtighten. Use of an electric screwdriver is not recommended.

Operating Instructions

Fig. 2
Single and double boxes – side view of bottom.

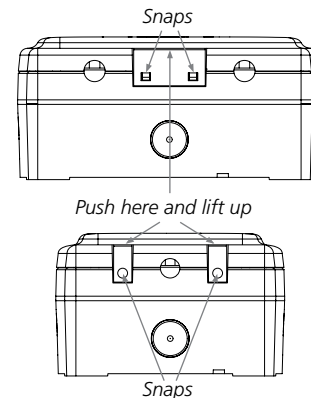

- The lid may be opened by pressing in the tab(s) on the front to release the snaps and then lifting the lid (see fig.2).
- Plugs may be inserted into the sockets and the socket switches turned on.
- The lid should then be closed to maintain the IP rating taking care to ensure that the cables are aligned with the centre of the cable seals (see fig. 3). Finally engage the snaps (see fig. 2) by pulling out the tab(s) while maintaining pressure to close the lid.

Fig. 3

Rear Box (double with 2 gang RCD sockets)

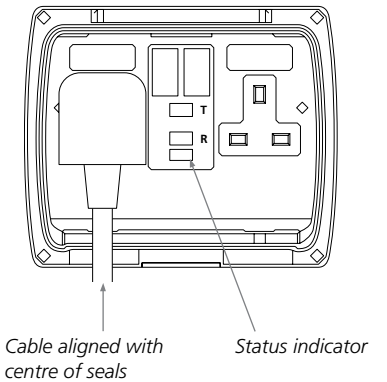

Cleaning

- Care should be taken when cleaning this product.
- Inside the lid should only be wiped with a clean dry cloth.
- The outside can be cleaned with mild detergent.
- Solvent based cleaners should not be used.
- Advice should be sought before installing this product in an environment where it is likely to be subjected to chemicals, oils or solvents.

Weathersafe Extreme Products with RCD's (WXT104, WXT204, WXT205)

Always test the RCD before use.

To test: Ensure supply is connected

RESET – press the grey (blue for WXT205) button marked Reset (R), the status indicator should show red.

TEST – press the red button marked Test (T), status indicator should show black. This indicates that the RCD has been tripped and power has been disconnected from the outlet.

RESET – press the grey (blue for WXT205) button marked Reset (R) again, the status indicator should show red.

If all the above operations work satisfactorily, the RCD is safe for use.

If the procedure is not completed satisfactorily do not use the RCD and seek professional advice.

In applications such as hand driers it may not be practical to expect each user to test before use. In this case we suggest an appropriate person applies the test routine twice a day.

To use: After satisfactorily testing the RCD, any connected appliance may be switched on, and used in the confidence that the user is protected from electric shock by rapid disconnection of supply.

Fig. 4
Rear of Front Panel (WXT104)

Live and Neutral Connections for Supply

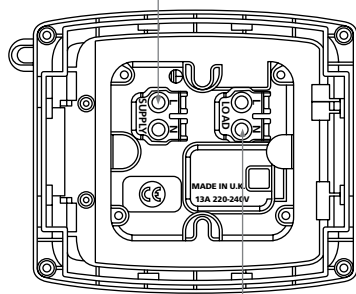

Live and Neutral Connections for Load
(Transposing Load and Supply Connections will cause damage to the unit)

If the RCD trips: Turn the appliance switch off, press the Reset (R) button and note that the status indicator turns red. Switch the appliance on and if the RCD trips again, switch off the appliance and do not use, as it may be faulty. Seek professional advice.

General RCD specifications

Voltage:	230V AC 50Hz
Max current:	Fully complies with the current rating required by BS1363
Rated trip current:	30mA
RCD type:	Double pole, suitable for 2 and 3 wire applications
Breaking capacity:	250A (Earth leakage)
Through fault withstand:	1500A
Operating temperature range:	-5°C to 40°C
Trip speed:	Less than 40msec at 150mA residual current
Fully complies with:	BS7288 & BS1363

Safety issues to remember

- Electricity can be dangerous, use of an RCD should not be regarded as a substitute for basic electrical safety precautions.
- Always test the RCD before use. If the test procedure is not completed satisfactorily or an appliance continues to trip the RCD seek professional advice and switch off the appliance.**
- To clean, use a clean dry cloth only. Do NOT use any liquid cleaners.
- A warming of the case during use is normal.

Wiring tests – important

Remove this product from circuit if carrying out tests (as described in the IEE Wiring Regulations) for earth loop impedance, prospective short circuit current and insulation resistance.

Use the enclosed warning label to ensure this is carried out.

Weathersafe Extreme Products with Timeswitches (WXT203)

The WXT203 provides a time controlled 13A socket outlet.

Features

- Permanent ON/OFF facility.
- Shortest switching time of 15 minutes, increasing in 15 minute steps.
- Up to 48 ON/OFF switchings per day.

Connections

Connect to terminals as shown in fig. 5.

Timer instructions

Programming

- Decide what times you would like the timeswitch to switch ON and OFF.
- Push all the segments in towards the centre of the timeswitch for the complete duration of an OFF period and leave them all in the outer position for the ON period (see fig. 3). The minimum switching interval is 15 minutes and this can be increased in 15 minute steps.
- Bring the timer into the correct condition by manually turning the programming ring clockwise through a 24 hour cycle. Note: when an ON/OFF or OFF/ON segment transition passes the time indicator a slightly increased resistance to movement is felt.
- Turn the programming ring clockwise until the correct time of day on the ring lines up with the time indicator.

Fig. 5
WXT203 – Wiring Connection

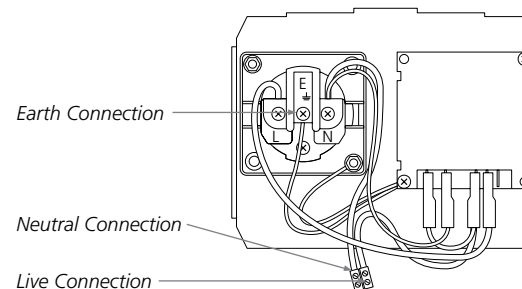

Points to note:

- The segment dial can be turned when the time controller is operating.
- In case of power failure, re-adjust the time controller to the correct time of day, turning the dial in a clockwise direction.

Permanent Override

By rotating the central switch clockwise so that the 'I' symbol lines up with the time marker the unit will be permanently ON.

With the ⊕ symbol lining up with the time marker the unit acts as a time switch.

With the ○ symbol lining up with the time marker the unit will be permanently OFF.

Fig. 6
WXT203 – Timer controls

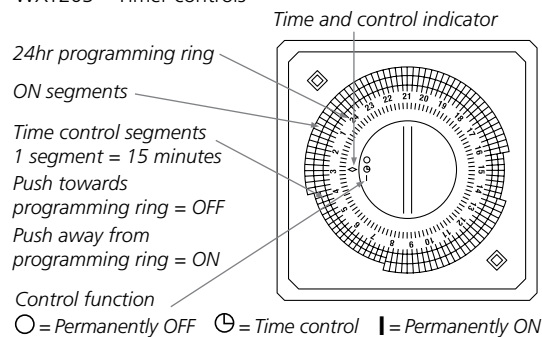

Weathersafe Extreme Switch Products (TGVL01, TGVL02, TGVL03, TGVL05 in common with Vision range)

To take switch apart first remove switch rocker (actuator). This may be done by inserting a flat blade screwdriver between the case and rocker as shown in fig. 7 and levering the rocker off at its pivot point. Be sure to protect the casing under the screwdriver blade with a piece of card as shown.

Fig. 7
Rocker Removal – TGVL Range

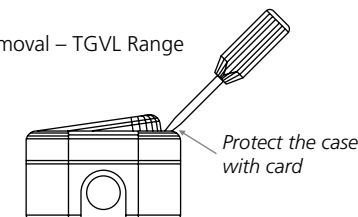

Concerning TGVL01, TGVL02, TGVL03 only.

If a local neutral is required to give permanent indication of switch position using the neon supplied, or for wiring purposes, then use one of the earth terminals shown in fig. 8 as a neutral wiring terminal.

Note:
This is the only way the neon should be connected.

Fig. 8
TGVL01, TGVL02, TGVL03 Earth terminal positions.

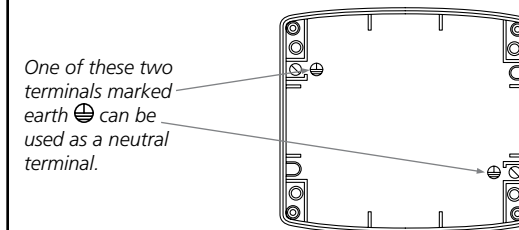

3 Year Guarantee

In the unlikely event of the product becoming faulty due to defective material or manufacture within 3 years of the date of purchase, please return it to your supplier in the first year with proof of purchase and it will be replaced free of charge. For the second and third years or any difficulty in the first year telephone the helpline on **020 8450 0515**

For assistance with the product please contact :-

HELPLINE
020-8450-0515
or email helpline@timeguard.com



For a product brochure please contact:

Timeguard Ltd.
020-8452-1112

or email csc@timeguard.com

A **Thoburn** Group company