

Socket Outlets

Standards and approvals

Metalclad Plus 13A socket outlets comply with BS 1363: Part 2: 1995.

Technical specification

Electrical

Voltage rating:
250V a.c.

Current rating:
13A per socket outlet

Terminal capacity:
Live, neutral & earth
3 x 2.5mm²
3 x 4mm²
2 x 6mm² (stranded)
(Dual earth terminals on list Nos.
K850 ALM, K2977 ALM, K2477 ALM, K2945 ALM)

Physical

Ambient operating temperature:
-5°C to +40°C
(not to exceed an average of more than 25°C in any 24 hour period)

IP rating:
IP2XD

Max. installation altitude:
2000 metres

Box Knockouts:
1 gang
6 x 20 dia
2 in one side
1 in each of the other 3 sides
1 in base

2 gang
8 x 20 dia
3 in top
2 in bottom
1 in each side
1 in base



Description

A range of socket outlets designed for ease of installation and having all the advantageous design features of the Metalclad Plus range. The 2 gang sockets with outboard rockers are of particular value for use by the infirm and partially sighted.

Non-standard, clean earth sockets are for use on installations where restricted access is required and will only accept MK LN647 13A non-standard plug with T-shaped earth pin. The sockets have two independent earth terminals so that they can also be used for 'clean earth' installations.

K850 ALM, K2977 ALM, K2477 ALM, K2945 ALM and K2757 WHI are fitted with two earth terminals on a common busbar to provide a double earth facility for use when installations require a high integrity protective connection as specified within BS7671 IEE Wiring Regulations.

The products can be quickly installed as replacement for existing 13 amp sockets or in a new installation.

Round pin sockets

A range of round pin sockets is also available, switched and unswitched.

Features

- Moulded 'on' indicator flash on switches will not rub off – totally safe
- Optional neon indicators in the switch rockers with 175° visibility in the horizontal and vertical planes
- 3 pin operated safety shutter
- White terminal markings on grey rear mouldings for clearer identification
- Top access, angled terminals make wiring easier and quicker
- 3mm minimum switch contact gap
- Double pole switching
- Choice of inboard or outboard positioned rockers
- Frontplates and backboxes manufactured from heavy gauge steel
- Additional electrical safety from neutral 'make first', 'break last' feature
- Switch contacts with silver contacts on both surfaces for good continuity
- Only one size of screwdriver required for installation
- Dual earth terminals for high integrity earthing on list Nos. K850 ALM, K2977 ALM, K2477 ALM, K2945 ALM, K2757 WHI
- Backed out and captive terminal screws
- Non-standard 'clean earth' sockets available
- Socket inserts manufactured from tough thermoplastic

Socket Outlets

Installation

Metalclad Plus socket outlets can be wall or bench mounted. Do not mount or use as a trailing socket or where they may be subject to excessive moisture or dampness.

2 gang switchsocket – view from rear

Top-facing, angled, backed-out terminals make wiring easier and quicker.



BOX TYPES			
	Flush	Flush (for extra wiring space)	Surface Metal
1 gang	861 ZIC	866 ZIC	as supplied
2 gang	862 ZIC	886 ZIC	as supplied

Dimensions (mm)

1 gang

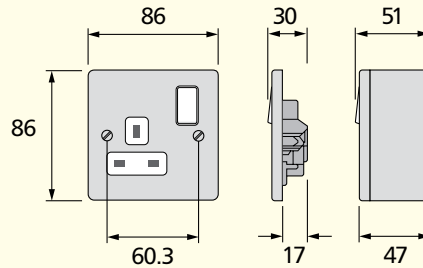

2 gang

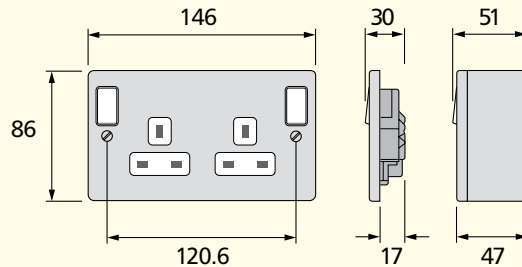
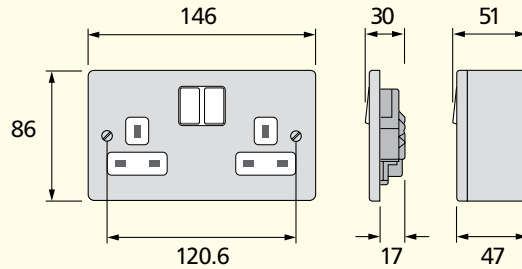

Sentrysocket RCD Protected Switchsocket Outlets

Compliance with EC Directives, Standards and approvals

All Sentrysockets comply with the following EC Directives and are CEmarked:

Low Voltage Directive
Electromagnetic Compatibility Directive (89/336/EEC)

Sentrysocket RCD Sockets also comply with the requirements of the following standards:

BS 7288: 1990
BS EN 50082-1

Sentrysocket RCD Double Sockets comply with BS 7288: 1990 and BS EN 61543: 1996

Technical specification

Electrical

Rated Voltage:
240V a.c.

Current rating:
13A resistive

Rated tripping current:
30mA and 10mA versions

Terminal capacity:
3 x 4mm²

Physical

Ambient operating temperature:
-5°C to +40°C

IP rating:
IP2XD

Max. installation altitude:
2000 metres

BOX TYPES

Surface

Metalclad Plus	K897 ALM (Spare Box)
----------------	----------------------

Metalclad Plus products have the mounting box included with the product. They are suitable for surface mounting only. Available for Single or Double Sockets.

Installation

Sentrysocket outlets can be wall or bench mounted. Do not mount or use as a trailing socket or where they may be subject to excessive moisture or dampness.



Description

Sentrysocket provides a high level of protection against electrocution and gives further protection when used with appliances vulnerable to insulation damage, particularly when they are in damp environments or outdoors. Sentrysocket is not suitable for mounting in damp environments or outdoors.

Sentrysocket, incorporating an RCD, is part of a complete range of fixed and portable wiring devices and circuit protection devices suitable for use in domestic, commercial and industrial applications.

Active control circuit

Sentrysocket products with an active control circuit incorporate a 'Re-set' mechanism and are mains failure sensitive, i.e. they will function under all the normal conditions expected of an RCD, but will also trip in the event of a power cut or a sudden, dramatic reduction in mains voltage. This makes them ideal for use where it would be hazardous for equipment to suddenly energise after return of mains power, such as use with rotating machinery and heat developing apparatus.

Passive control circuit

Sentrysocket products with a passive control circuit incorporate a 'Stay-set' mechanism and is mains failure proof, i.e. it will function under all the normal conditions expected of an RCD and will not trip in the event of a power cut. This makes it suitable for use with freezers or in inaccessible or unmanned locations.

Features

- Suitable for most residential, commercial and light industrial applications
- Active and passive control circuit applications
- Comply fully with current Wiring Regulations
- Double pole switching
- Flexible and versatile in use
- Ideal for use with equipment subject to wet weather or high humidity
- Part of a complete range of MK circuit protection devices
- They are a.c. and pulsating d.c. sensitive for residual current

Dimensions (mm)

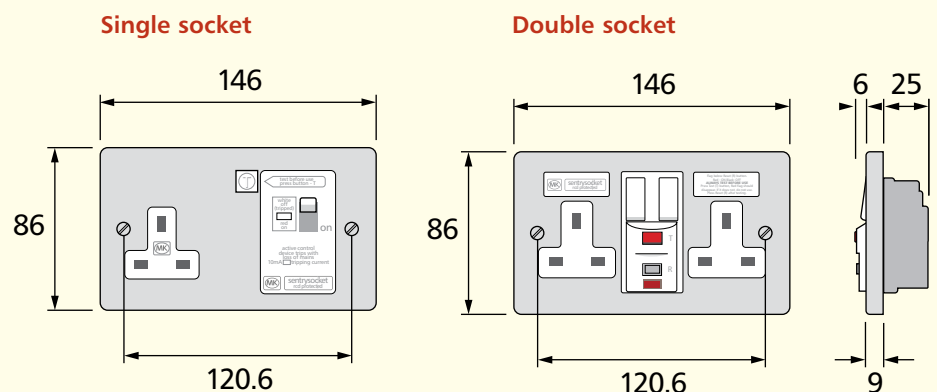

Round Pin Socket Outlets

Standards and approvals

Round pin socket outlets comply with BS 546: 1950.

Technical specification

Electrical

Voltage rating:
250V a.c.

Terminal capacities:
2 amp sockets (K841):
7 x 1mm²
4 x 1.5mm²
2 x 2.5mm²
1 x 4mm²

5 amp sockets (K842):
3 x 2.5mm²
2 x 4mm²

15 amp sockets (K843):
3 x 2.5mm²
3 x 4mm²
2 x 6mm² (stranded)

Physical

Ambient operating temperature:
-5°C to +40°C
(not to exceed an average of more than 25°C in any 24 hour period)

IP rating:
IP2XD

Max. installation altitude:
2000 metres



Description

A range of round pin socket outlets designed for ease of installation and having all the advantages and design features of the Metalclad Plus range. These products can be quickly installed as replacements for existing socket outlets or in new installations.

Features

- Top access terminals make wiring easier and quicker
- Integral ON indicator on switches will not rub off – totally safe
- 3mm minimum switch contact gap
- Double pole switching
- Terminal screws backed out
- Additional electrical safety from neutral “make first”, “break last” feature on switched sockets
- Switch contacts with silver contact points on both surfaces for good continuity
- 5A and 15A sockets contain a 3 pin operated safety shutter
- Printed terminal markings on grey rear mouldings for clearer identification
- 2A socket shuttered

Installation

Metalclad Plus socket outlets can be wall or bench mounted – do not mount or use as a trailing socket or where they may be subjected to excessive moisture or dampness.

Cable management

Metalclad Plus socket outlets can be mounted in a variety of MK trunking systems.

Dimensions (mm)

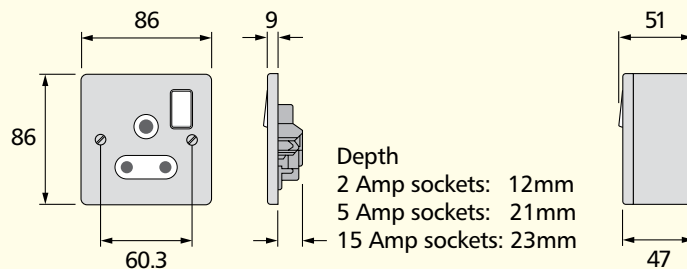

15A American Socket Outlet

Standards and approvals

Complies with SASO 2203: 2003

Technical specification

15A American

Electrical

Voltage rating:
127V a.c.

Current rating:
15A

Terminal capacity:
Live, neutral & earth
3 x 2.5mm²
2 x 4mm²
1 x 6mm² (stranded)

Physical

Ambient operating temperature:
-5°C to +40°C
(not to exceed an average of more than 25°C in any 24 hour period)

IP rating:
IP2XD

Max. installation altitude:
2000 metres



Dimensions (mm)

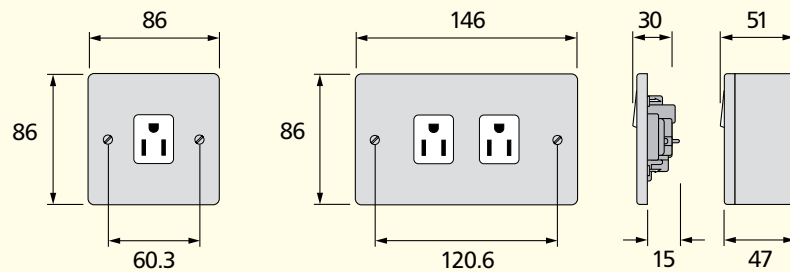

Installation

Metalclad Plus socket outlets can be wall or bench mounted. Do not mount or use as a trailing socket or where they may be subject to excessive moisture or dampness.

Connection Units and 20ADPSwitches

Standards and approvals

Connection units comply with BS 1363: Part 4: 1995.

20A DP switches comply with BS EN 60669-1: 2000.

Fuses are to BS 1362.

Technical specification

Electrical

Voltage rating:
250V a.c.

Current rating:
Connection units – 13 amp
DP switches – 20 amp

Terminal capacity:

Supply terminal: 2 x 6mm² stranded
 2 x 4mm²
 3 x 2.5mm²

Load terminals: 2 x 6mm² stranded
 2 x 4mm²
 3 x 2.5mm²

Flex outlet/cord grip capacities:

Connection units: min: 2 core, 0.5mm
 max: 3 core, 1.5mm

20 amp DP switches: min: 3 core, 1.5mm
 max: 3 core, 2.5mm

Physical

Ambient operating temperature:
–5°C to +40°C
(not to exceed an average of more than 25°C
in any 24 hour period)

IP rating:
With flex outlet: IP2XD
Without flex outlet: IP4X

Max. installation altitude:
2000 metres

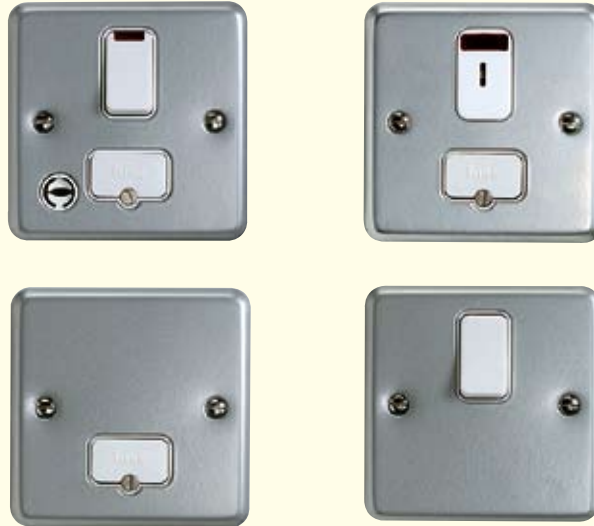

Description

A range of 13A fused connection units and 20A DP switches designed for the connection of refrigerators, water heaters, central heating boilers and other fixed appliances.

The ranges are designed for ease of installation and have the advantageous design features of the Metalclad Plus range.

Neon indicators

Neon indicators can be included in the rockers of the switched connection units. In the case of unswitched units, they are located centrally and uppermost on the face plate. Neon indicators are integrally wired into the product and do not require separate connection when installing.

The design gives 175° visibility in the horizontal and vertical planes.

Fuse carriers

These are captive and are opened by a fast acting, screwdriver operated worm drive for ease of replacement.

A tamper-proof version is also available.

Fuse carriers can be locked open using a padlock, List No. K2000.

Flex outlets

The products are equipped with very strong, push-fit nylon cord grips making installation safe, quick and easy.

Connection Units and 20ADPSwitches

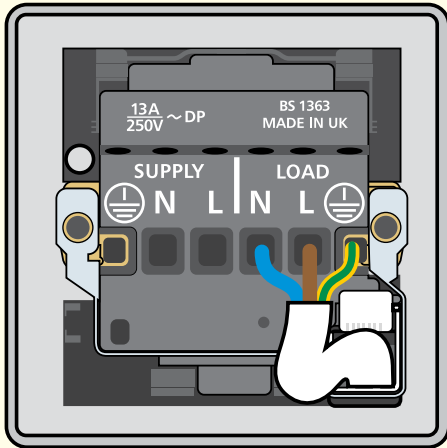

Front outlet cord grip



Lockable fuse carrier

Installation

Metalclad Plus connection units and 20A cable outlets and switches can be wall or bench mounted. Do not use on a trailing lead.

Wiring

Products must be installed in accordance with current IEE Regulations.

Box types

Supplied with a box having 2 x 20 mm knockouts in one side, as well as 1 x 20 mm knockouts in each of the other three sides and the bottom of the box.

Spare boxes are available without side knockouts (K829 ALM).

All boxes have a knockout in the base.

Features

- Optional indicators in the switch rockers with 175° visibility in the horizontal and vertical planes
- Worm-drive operated fuse carriers for additional security (tamper-proof version available)
- Fuse carrier lockable in open position
- All supply and load cables can be cut and stripped to the same length
- Integrally wired indicators save installation time
- Push-fit cord grips, for safer, quicker installation
- Angled, top mounted terminal screws simplify wiring
- Moulded 'on' indicator flash on switches cannot rub off – totally safe
- Captive fuse carrier
- Additional electrical safety from neutral 'make first', 'break last' feature
- Secure cable and flexible cord connection
- All terminal and fixing screws operated by one-size (4mm) screwdriver
- Backed out and captive terminal screws

Box types

Supplied with a box having 2 x 20 mm knockouts in one side, as well as 1 x 20 mm knockouts in each of the other three sides and the bottom of the box.

Spare boxes are available without side knockouts (K829 ALM).

All boxes have a knockout in the base.

Dimensions (mm)

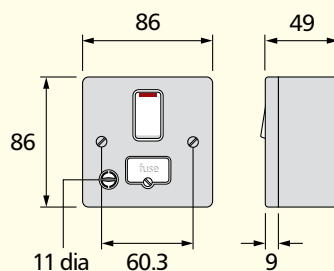

Plateswitches

Standards and approvals

All Metalclad Plus plateswitches comply with BS EN 60669-1:2000

Technical specification

Electrical

Voltage rating:
250V a.c. 50Hz

Current rating:
10 amps – no derating when used on fluorescent or inductive loads

Terminal capacity:

All products –
4 x 1mm²
4 x 1.5mm²
3 x 2.5mm²
2 x 4mm²
1 x 6mm²

Contact gap:
3mm switch contact gap

Physical

Operating temperature:
–5°C to +40°C

IP rating:
IP4X

Max. installation altitude:
2000 metres

Operational testing (all plate switches):
tested to 100,000 operations for mechanical life
tested to 30,000 operations at 10 amp rating



Description

A comprehensive range of tough, impact resistant, surface mounted plateswitches. They have been designed to suit a wide variety of applications in factories, workshops, plant rooms, warehouses, schools and hospitals.

The frontplate has smooth chamfered edges engineered to fit flush with the backbox.

Backboxes with or without side knockouts are available and all have a central knockout in the base.

Wide rocker switches are also available.

Features

- Two way switches can be wired as one or two way
- All products clearly printed with BS Nos., ratings, etc
- Matching Grid switches available in 10 or 20A ratings
- 3mm switch contact gap
- Positive switch action
- Top access, backed out and captive terminal screws
- Metalclad Plus is supplied with white inserts only
- An earth terminal is provided attached to rear of product and in base of mounting box

BOX TYPES

	Flush	Surface
All 1,2 and 3 gang switches	3995 ZIC	K2160 WHI
All these products are designed primarily for surface mounting and are supplied complete with mounting box. If flush mounting is required then recommended box is 3995 ZIC 16mm deep.		

Plateswitches

Dimensions (mm)

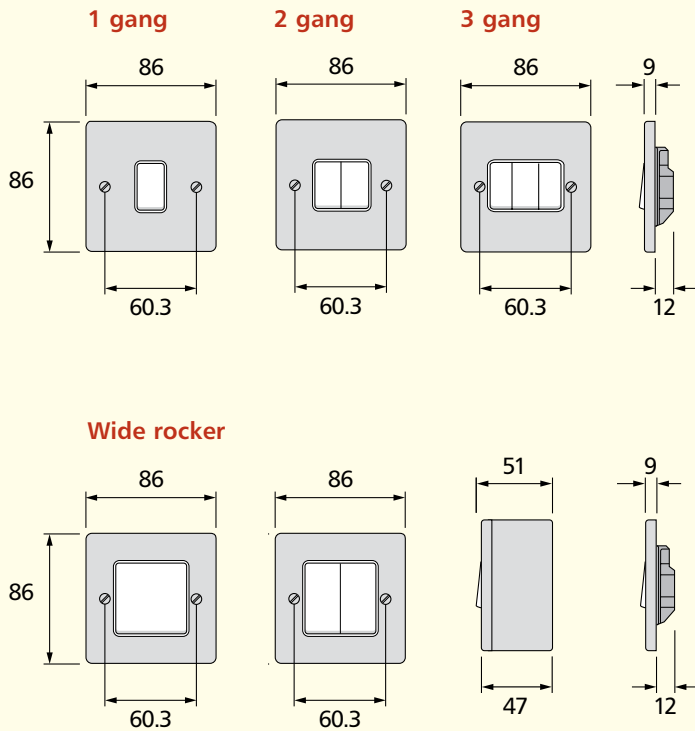

Wiring Diagrams

One-way switching

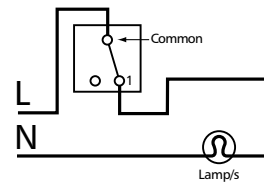

Two-way switching – 2 wire control

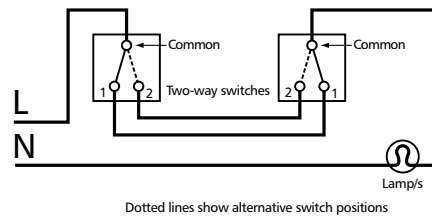

Two-way switching plus intermediate switching – 2 wire control

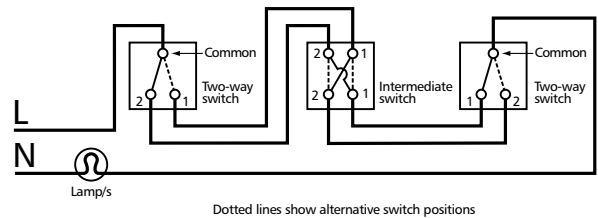

Two-way switching – 3 wire control

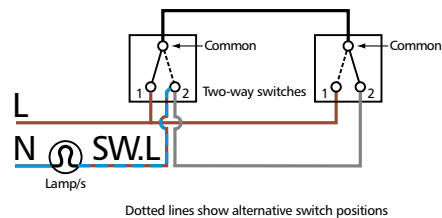

Two-way switching plus intermediate switching – 3 wire control

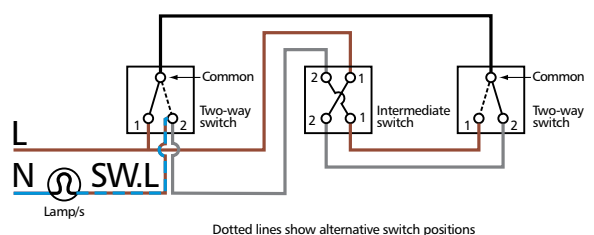

N.B. Terminal positions may alter. The above diagrams are to show wiring layout.

High Current Switches

Standards and approvals

All DP switches in the range conform to BS EN 60669-1: 2000

Technical specification

Electrical

Voltage rating:
250V a.c.

Current:
32/45A resistive

Switch:
3mm contact gap
Double pole operation

Terminal capacity, 45A Switches
4 x 4mm²
3 x 6mm²
1 x 16mm²

Terminal capacity, 32A Switch:
3 x 2.5mm²
2 x 4mm²
1 x 6mm²

Physical

Ambient operating temperature:
-5°C to +40°C
(not to exceed an average of more than 25°C in any 24 hour period)

IP rating:
IP4X

Max. installation altitude:
2000 metres

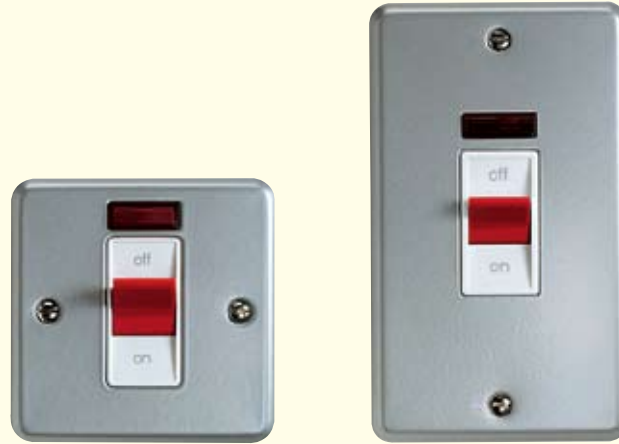

Description

A range of switches and cooker control units harmonising with the Metalclad Plus style, suitable for the switching of all domestic, commercial and industrial appliances where higher current ratings are required, i.e. cookers, heaters, commercial refrigeration units etc. Metal units are particularly suitable for refurbishment projects.

Features

- Positive switch action
- Positive double pole switching
- Toggle action switches
- Very robust paint finish
- Metal frontplates
- Replaceable neon indicators

Note: These switches are not recommended for switching large banks of PCs

Box types

32A switch supplied with a box having 2 x 20mm knockouts in one side, as well as 1 x 20mm knockout in each of the other three sides and the bottom of the box.

45A switch supplied with a box having 3 x 20mm knockouts in one of the long sides and 2 x 20mm knockouts in the other. Both short sides and the bottom of the box have 1 x 20mm knockout.

Spare boxes are available for both size of product with no knockouts in any of the sides (K829 ALM for 32A, K830 ALM for 45A). A knockout is retained in the bottom of each box.

BOX DEPTHS			
List No.	Max. cable size	Flush	Surface
Switches			
32A	10mm ²	46mm	40mm
45A	10mm ²	47mm	40mm

BOX REFERENCES		
Flush	32A	45A
Box depth		
46mm	877 ZIC	–
47mm	–	878 ZIC

Dimensions (mm)

K5240 ALM

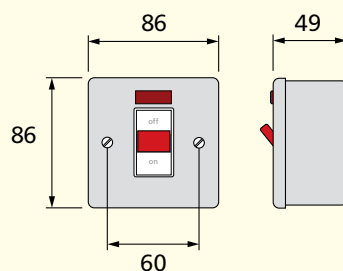

K5230 ALM

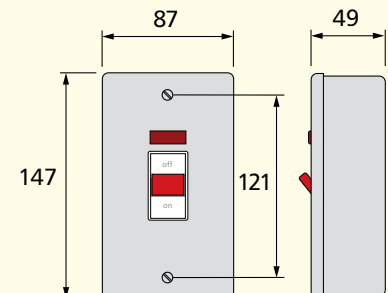

Three Pole Fan Isolators

Standards and approvals

Comply with BS EN 60947: 1992

Technical specification

Electrical

Voltage rating:
250V a.c. 50Hz

Current rating:
10 amps

Terminal capacity:
4 x 1mm²
4 x 1.5mm²
3 x 2.5mm²
2 x 4mm²
1 x 6mm²

Contact gap:
3mm switch contact gap

Classifications

Method of operation: Stored energy operation
Suitability for isolation: Suitable for isolation

Ratings

Utilisation category	AC23B
Rated operational voltage (Ue)	250V
Conventional free air thermal current (Ith)	10A
Rated frequency	50Hz
Rated making capacity	100A rms
Rated breaking capacity	80A rms
Rated conditional short-circuit current	6000A rms
(with supply side protective device GEC NIT 16 BS88: part 2: 1988 16A 550VAC utilisation category gG 80KA breaking capacity fuse links.)	

Physical

Operating temperature:
-5°C to +40°C

IP rating:
IP4X

Max. installation altitude:
2000 metres



Description

The MK Three Pole Fan Isolator provides a safe and simple method of isolating mechanical fan units and is particularly useful in bathrooms, toilets, storerooms and basements where there is little or no natural light.

For example, timer controlled fans are often linked into the lighting circuit for energy saving and convenience. In such an installation there is often a need for the lighting circuit to remain live to provide light whilst the fan unit is externally isolated so that routine maintenance and repairs can be carried out in complete safety.

The K2857 fan isolator can be used as a double pole or triple pole isolator. In addition it includes a clear on/off indicator and the frontplate features a fan isolator symbol for easy circuit identification.

Dimensions (mm)

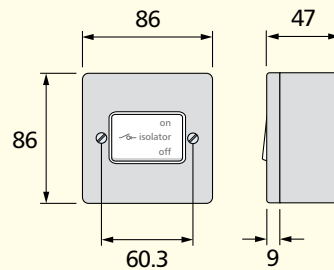

Features

- Switchlock list no. K4858 is available to allow the isolator to be locked in the disconnected position to facilitate fan maintenance

Three Pole Fan Isolators

Wiring Diagrams

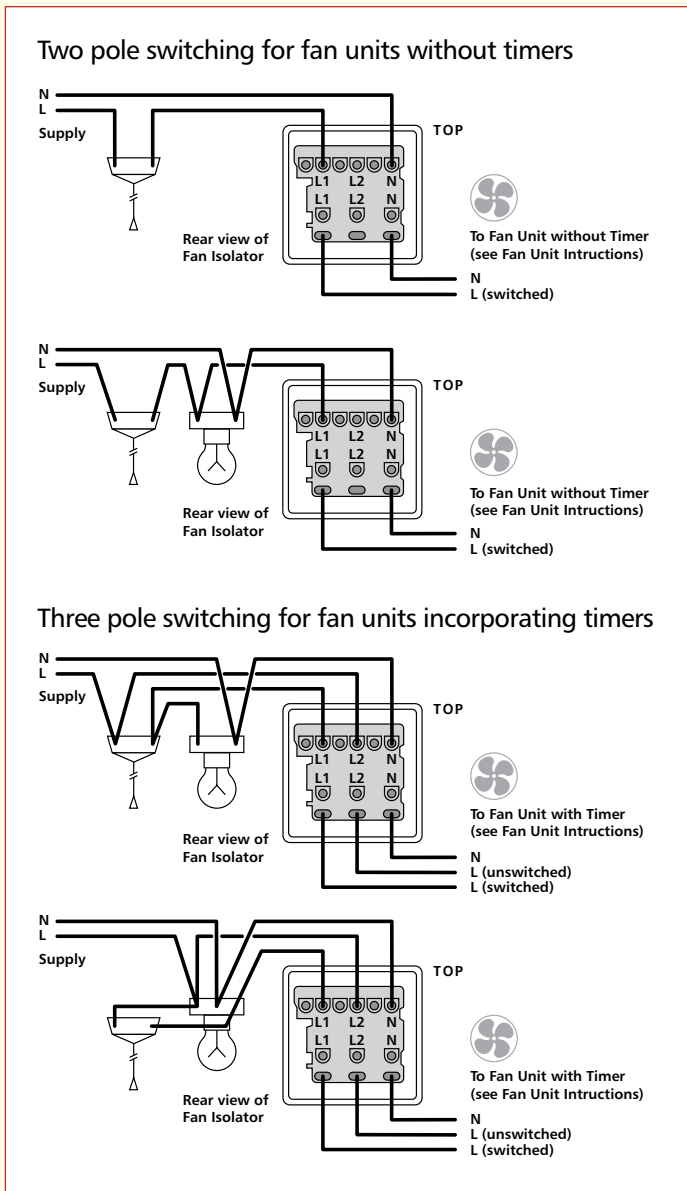

Euro and LJU6C Data Frontplates

Standards and approvals

BS 5733: 1995

Technical specification

Dimensions

Height:	86mm
Width:	86mm (1G)
	146mm (2G)
Depth:	9mm

Aperture Dimensions (Nominal)

Euro Frontplates

Height:	50mm
Width:	50mm (1G)
	100mm (2G)

LJU6C Frontplates

Height:	37mm
Width:	22mm

Features

- 1G and 2G frontplates
- Metalclad Plus style
- Accept industry standard Euro or LJU6C snapfit modules
- K181 Euro frontplate accepts 1 Euro module, (25 x 50mm aperture)
- K182 Euro frontplate accepts 2 Euro modules, (50 x 50mm aperture)
- K184 Euro frontplate accepts 4 Euro modules, (100 x 50mm aperture)
- K172 LJU6C frontplate accepts two LJU6C modules (27 x 37mm aperture)
- 1/2 module (12.5 x 50mm) blank available for Euro frontplates
- Interchangeable modules clip into frontplate



Description

Frontplates used for mounting snapfit data modules.

Dimensions (mm)

Euro Frontplates

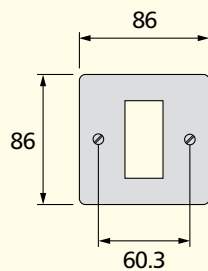

1 module
K181 ALM

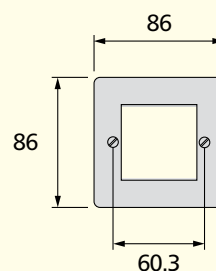

2 module
K182 ALM

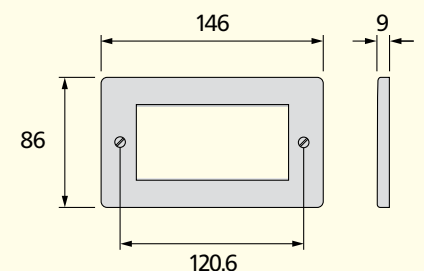

4 module
K184 ALM

LJU6C Frontplates

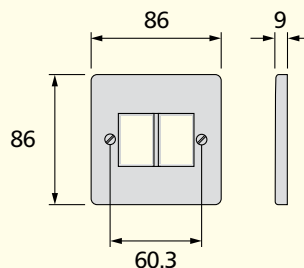

2 module
K172 ALM

RJ45/ISDN Data Outlets

Standards and approvals

BS EN 50173.
IEC 11801.
TIA/EIA 568A.



Description

Suitable for use in all LJU6C, Euro and MKModular frontplates, available in the Metalclad Plus range, Cat5/5e and ISDN modules suitable for use in structured cabling distribution systems. ISDN modules incorporate a line terminating resistor.

Installation

- Maximum cable length 90m.
- Cable bend radii, 40mm during installation, 20mm after installation.
- Maximum pull force 8.7kg.
- Do not over tighten cable ties.
- Do not unwind the twists in the wire pairs by more than 13mm max.

BOX TYPES	
	Depth
UTP	25mm
STP	35mm

BOX TYPES		
Cat 6	Depth	Note
UTP	35mm	Edge/Insignia and Aspect require 45mm box depth
STP	35mm	Edge/Insignia and Aspect require 45mm box depth
Cat 5e	Depth	Note
UTP	25mm	Edge/Insignia and Aspect require 35mm box depth
STP	35mm	Edge/Insignia and Aspect require 46mm box depth

Installation details and wiring diagram illustrations

TIA WIRING SCHEME COLOUR CODES:

Pin No.	568A	568B
1	WHITE / green	WHITE / orange
2	GREEN / white	ORANGE / white
3	WHITE / orange	WHITE / green
4	BLUE / white	BLUE / white
5	WHITE / blue	WHITE / blue
6	ORANGE / white	GREEN / white
7	WHITE / brown	WHITE / brown
8	BROWN / white	BROWN / white

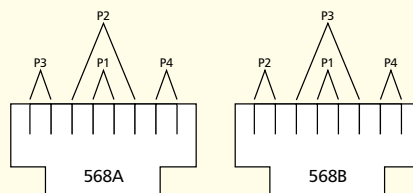

Pair 1 – BLUE/white & WHITE/blue
 Pair 2 – ORANGE/white & WHITE/orange
 Pair 3 – GREEN/white & WHITE/green
 Pair 4 – BROWN/white & WHITE/brown

Euro and LJU6C modules are to be wired as follows

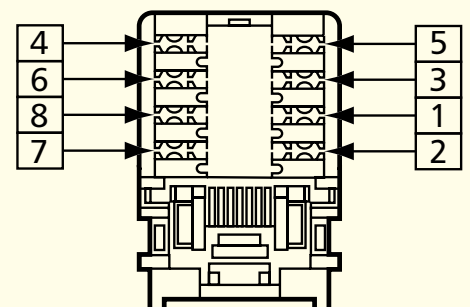

Telephone, RJ11/12, BNC Data and Blank Modules

Standards and approvals

Telephone sockets K5820 and K5821 comply with the following:
BS 6312: 2.2, OFTEL Approval NS/G/23/U/100005.
Data sockets K5801, BS 5733:1995 (where applicable).
K5887 complies with FCC68.



Technical specification

Electrical

Cable types:

Telephone: CW1311, CW1293, CW1308, CW1316

No. of cables per termination:

Telephone: 2
RJ11/12: 1

BNC

50. impedance cable – RG58, RG141, URM43 Belden 9907

Frequency range:

BNC connector: 0 to 4GHz

Impedance:

BNC Connector: 50. nominal

Termination type:

Telephone module – IDC
BNC module – Crimped connection

Physical

Temperature range:

Ambient air –20°C to +60°C

IP rating:

IP2XD – K5820, K5821, K5801 and K5787.
IP4X – K180, K188, K186 and K170

Max. installation altitude:

2000 metres

DIMENSIONS(mm)

List No.	Dimensions
K5820 / K5821 / K5801 / K188 / K5887	25 x 50
K180	50 x 50
K186	12.5 x 50
K5787/K170	22 x 37

Features

- Meet all relevant BS, OFTEL and cabling standards
- Interchangeable modules clip into frontplates
- Front fixing facilitates easy exchange of modules
- Part of a complete range of products for telephone and data processing requirements

Telephone sockets

- 100% tested before delivery
- Quick, simple and reliable IDC connectors

Description

A range of telephone, data and blank modules to fit Euro and LJ6UC front plates. BNC Euro modules with a 50ohm crimp connector suitable for use with RG58, URM43, URM76 and Beldon 9907 type co-axial cables are also available.

Installation (Telephone socket modules)

Product performance, systems compatibility

Master Sockets: For use as the first socket outlet on a direct exchange. They contain the required surge protector (for line protection against electrical surges) and ringing capacitor.

Secondary Sockets: for use as extension sockets when connected on the same line as a Master Socket.

Installation tools required IDCConnectors (telephone & RJ45 outlets)

MK insertion tool List No. 400 or 22630.

Wire pull-out force: 10.5 Newtons when installed correctly.

Wiring regulation restrictions

Domestic Installations: The total REN (Ring Equivalent Number) value of all telephone equipment connected on a line must not exceed 4.

BOX TYPES

K5820 / K5821	16mm
K5801 / K5887 / K5787	25mm

Data sockets

- Can be specified for all applications
- Fit in plaster depth boxes
- Latest specification for high performance systems
- Made to stringent quality assurance procedures
- Wide range of data connectors available

For information on TV Satellite and FM Modules see pages TD198 – TD199

BT Wiring Scheme

- 1 GREEN / white
- 2 BLUE / white
- 3 ORANGE / white
- 4 WHITE / orange
- 5 WHITE / blue
- 6 WHITE / green

Note: Main wire colour is shown in capitals

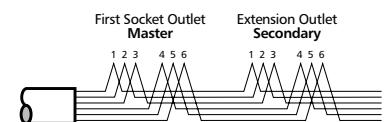
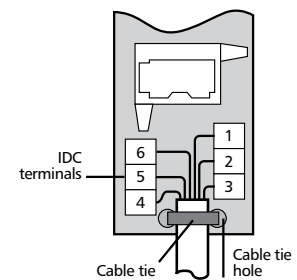

RJ11/12 Wiring Scheme

PIN NO.	STRIPPED COLOUR WIRE	SOLID COLOUR WIRE
1	WHITE / green	White
2	WHITE / orange	Black
3	BLUE / white	Red
4	WHITE / blue	Green
5	ORANGE / white	Yellow
6	GREEN / white	Blue

Note: Main wire colour is shown in capitals

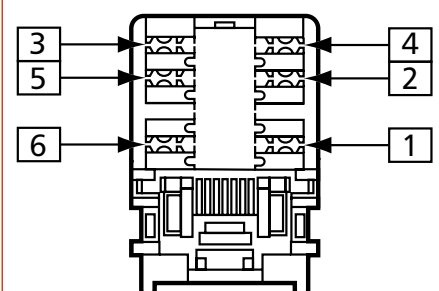

Digital TV and RadioOutlets

Standards and approvals

All MK Digital TV Outlets comply with BS 5733 and BS EN 50083 where applicable.

Also IEC 169-2, BS EN 60169-24 and BS 6312 part 2

Modular products are Euro compatible.

Technical specification

Single Outlets

TV/FMIEC Male or Female DC-950MHz
SATF-Type DC-1.75GHz

Diplexer and Triplexer products

TV

Diplexer: DC-68.5MHz, 174-862MHz
Triplexer: DC-68.5MHz, 174-862MHz

FM

Diplexer: 87.5-108MHz
Triplexer: 87.5-108MHz

SAT

Diplexer: n/a
Triplexer: DC-200kHz, 950-2400MHz

TV/FM/DAB/SAT products for digital radio

TV

Diplexer: 470-862MHz
Triplexer: 470-862MHz

FM/DAB

Diplexer: 87.5-230MHz
Triplexer: 87.5-230MHz

SAT or SAT1

Diplexer: n/a
Triplexer: 950-2400MHz

SAT2

Diplexer: n/a
Triplexer: DC-2300MHz

Features

- Non Isolated
- Fully screened
- Earth terminal provided on TV modules

Cable management

Digital TV outlets can be mounted in a variety of MK trunking systems.



Description

There are two ranges of diplexer and triplexer products, an established range suitable for VHFTV, and a range suitable for digital radio (DAB).

Diplexer modules are for connecting to a single co-axial aerial down lead carrying combined TV and FM signals. The filtering in the diplexer splits out the appropriate signal and feeds it to the relevant output connection. A DC control path is provided in the TV signal path through the diplexer.

Triplexer modules are for connecting to a single co-axial aerial down lead carrying combined TV, FM and SAT signals. The filtering in the triplexer splits out the appropriate signal and feeds it to the relevant output connection. A DC control path is provided in the SAT signal path through the triplexer.

The quad outlet contains a triplexer together with a separate satellite output, for use with Sky+, or more complex installations.

Installation

- When installing the TV Co-axial cable ensure that all cable bends are smooth so that the inner insulation is not crushed or squashed. Otherwise the TV signal quality may be affected.
- Not suitable for loop-in loop-out installations
- use CT100 cable (or equivalent.)

Dimensions (mm)

Euro 2 module (monobloc)

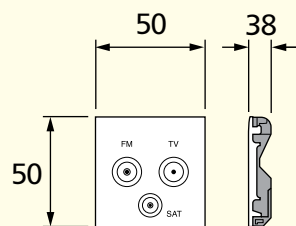

Euro 1 module (monobloc)

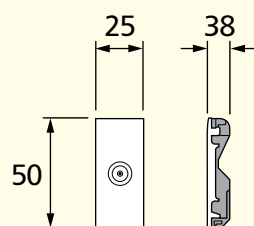

Note: Minimum box depth: 47mm

TV Co-axial cable stripping details

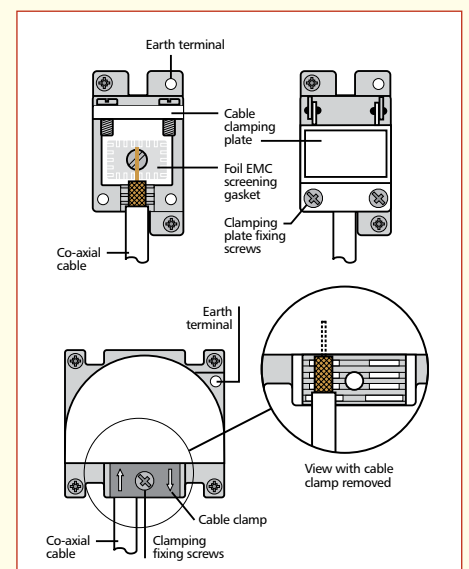
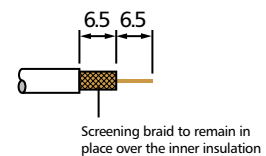

MK Modular Datacoms

Standards and approvals

Metalclad Telephone and Data sockets comply with the following:

Telephone sockets K452 and K457

BS 6312: 2.2, OFTEL Approval NS/G/23/L/100005

Data sockets K290 to K452, K458

BS 5733: 1995 (where applicable)

Data sockets K455

Cat 5e performance to EIA/TIA TSB568, BS EN 50173, IEC11801



Technical specification

Electrical

Cable types:

Telephone CW1311, CW1293, CW1308, CW1316

RJ45: 20 to 26 AWG, 100 ohm Cat 5e UPT cable

No. of cables per termination (Telephone & RJ45):

Telephone: 2

RJ45: 1

BNC

50 impedance cable – RG58, RG141, URM43
Belden 9907

Frequency range:

BNC connector: 0 to 4GHz

Impedance:

BNC Connector: 50 nominal

Termination type:

RJ45 & telephone module – IDC

BNC module – Crimped connection

Physical

Temperature range:

Ambient air –20°C to +60°C

IP rating:

IP2XD

Max. installation altitude:

2000 metres

Description

A unique modular system in the distinctive Metalclad Plus style comprising a range of socket modules for Data and Telephone use, with 4 to 2 matching frontplates capable of accepting combinations of interchangeable modules. Modules clip into mounting frames which, when attached to frontplates, provide a high degree of versatility, making the system ideal for use in all commercial and industrial applications.

Features

- Meet all relevant BS, OFTEL and cabling standards
- Part of a range of products for telephone and data processing requirements
- Interchangeable modules clip into grid frame which attaches to frontplate

Telephone sockets and frontplates

- Quick, simple and reliable IDC connectors
- Can be specified for all applications

Data sockets and frontplates

- Cat 5e specification performance
- Made to stringent quality assurance procedures

Dimensions – Data and TV modules (mm) (Minimum box depth 16mm)

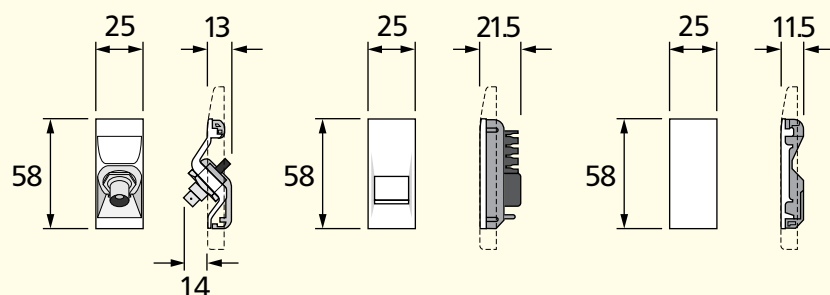

K451 WHI

K455 / K452 /
K457 / K458 WHI

K290 WHI

MK Modular Datacoms

Dimensions – Modular frontplates (mm)

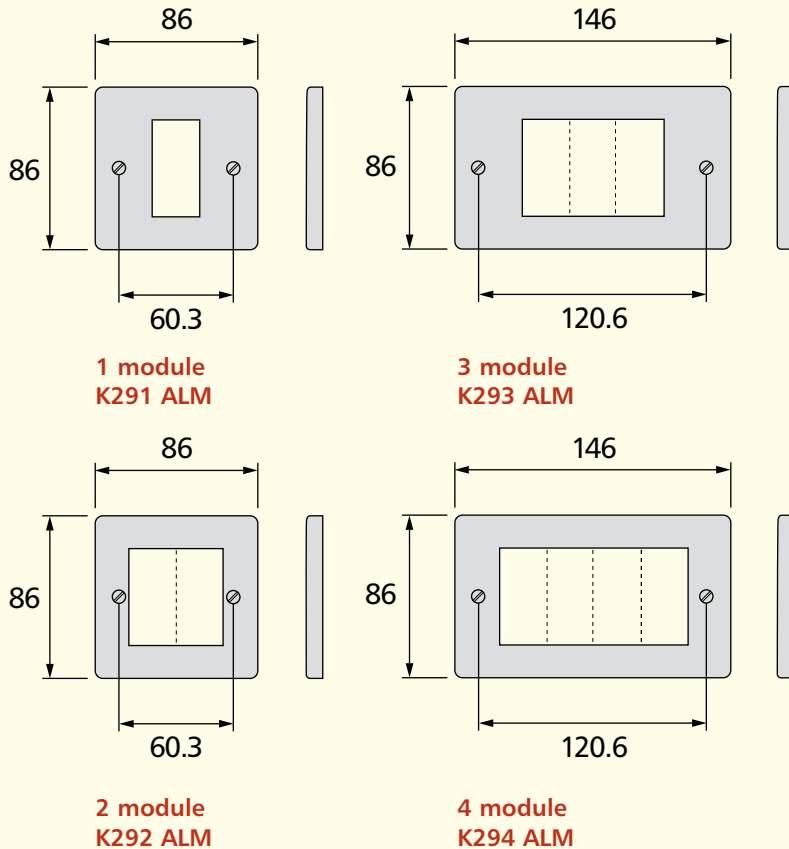

RJ11 Wiring Scheme

PIN NO.	STRIPPED COLOUR WIRE	SOLID COLOUR WIRE
1	WHITE / green	White
2	WHITE / orange	Black
3	BLUE / white	Red
4	WHITE / blue	Green
5	ORANGE / white	Yellow
6	GREEN / white	Blue

Note: Main wire colour is shown in capitals

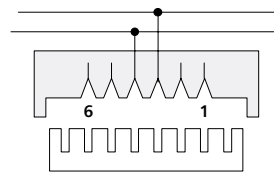

Rear View of Terminal Connection Block

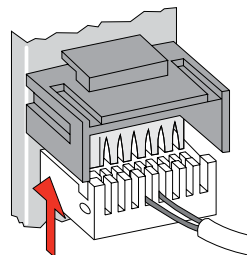
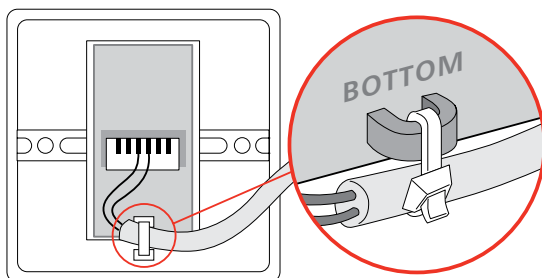

Installation (Data sockets)

RJ45 modules

In order to maintain Category 5e performance, install cabling in accordance EIA/TIA or ISO General Cabling Standards.

Installation (Telephone socket modules)

Product performance, systems compatibility

Master Sockets: For use as the first socket outlet on a direct exchange. They contain the required surge protector (for line protection against electrical surges) and ringing capacitor.

Secondary Sockets: for use as extension sockets when connected on the same line as a Master Socket.

Installation tools required IDCCconnectors (telephone & RJ45 outlets)

MK insertion tool List No. 400 or 22630.

Wire pull-out force: 10.5 Newtons when installed correctly.

Wiring regulation restrictions

Domestic Installations: The total REN (Ring Equivalent Number) value of all telephone equipment connected on a line must not exceed 4.

Industrial and commercial installations: MK telephone sockets are suitable in all situations after the PBX/PABX has been installed by a recognised installer. For key systems and other 'special' systems, the manufacturer's instructions should be referred to.

Safety information

None of the above products should be installed into the same fixing or mounting boxes as mains rated equipment or cable.

Note: For BT and RJ45 wiring scheme diagrams see pages TD197 and TD196 respectively.

Cable management

Metalclad Plus Modular Data and Telephone Sockets can be mounted in a variety of MK trunking systems. See main catalogue for further details.

Grid Plus Front Plates

Standards and approvals

BS 5733: 1995



Description

Grid Plus is a comprehensive modular switching and monitoring system ideal for a variety of applications within the commercial, public and domestic sectors.

Dimensions

