

RoHS  **312/318 Series** Lead-Free 3AG, Fast-Acting Fuse

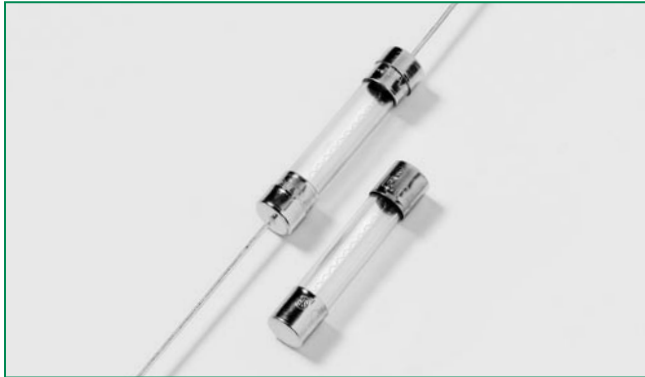







Description

The 3AG Fast-Acting Fuse solves a broad range of application requirements while offering reliable performance and cost-effective circuit protection.

Features

- In accordance with UL Standard 248-14
- Available in cartridge and axial lead format and with various forming dimensions
- RoHS compliant and Lead-free

Agency Approvals

Agency	Agency File Number	Ampere Range
	E10480 AU1410	312 Series: 62mA - 10A 318 Series: 62mA - 10A 312 Series: 12A - 30A
	LR 29862	312 Series: 62mA - 30A 318 Series: 62mA - 10A
	NBK040205- E10480B/F	312/318 Series: 1A - 10A
	E10480	318 Series: 12A - 30A
	SU05001- 5005/5006/6005/6008	312/318 Series: 1A/ 1.25A / 1.6A/ 2A - 10A
		312 Series: 62mA - 10A 318 Series: 62mA - 10A

Applications

Used as supplementary protection in appliance or utilization equipment to provide individual protection for components or internal circuits.

Electrical Characteristics for Series

% of Ampere Rating	Ampere Rating	Opening Time
100%	62mA – 35A	4 hours, Minimum
135%	62mA – 35A	1 hour, Maximum
200%	10mA – 10A	5 sec., Maximum
	12A – 30A	10 sec., Maximum
	35A	20 sec., Maximum

Electrical Characteristic Specifications by Item

Amp Code	Ampere Rating (A)	Voltage Rating (V)	Interrupting Rating	Nominal Cold Resistance (Ohms)	Nominal Melting I ² t (A ² sec)	Agency Approvals					
						UL	cULus	K	PS E	SF	CE
.062	0.062	250	35A@250Vac 10KA@125Vac	24.7000	0.000249	x				x	x
.100	0.1	250		11.2800	0.00102	x				x	x
.125	0.125	250		7.1450	0.00289	x				x	x
.150	0.15	250		5.1300	0.00550	x				x	x
.175	0.175	250		3.8750	0.00960	x				x	x
.187	0.187	250		3.4200	0.0128	x				x	x
.200	0.2	250		3.0200	0.0165	x				x	x
.250	0.25	250		2.0100	0.0355	x				x	x
.300	0.3	250		1.4050	0.0689	x				x	x
.375	0.375	250		0.8250	0.185	x				x	x
.500	0.5	250		0.4980	0.483	x				x	x
.600	.6	250		0.3620	0.880	x				x	x
.750	0.75	250		0.2445	1.84	x				x	x
001.	1	250		0.1900	0.760	x		x	x	x	x
1.25	1.25	250		100A@250Vac 10KA@125Vac	0.1385	1.45	x		x	x	x
01.5	1.5	250	0.1036		2.35	x			x	x	x
01.6	1.6	250	0.0934		2.80	x		x	x	x	x
1.75	1.75	250	0.0856		3.60	x			x	x	x
01.8	1.8	250	0.0825		3.85	x			x	x	x
002.	2	250	0.0704		5.20	x		x	x	x	x
2.25	2.25	250	0.0594		7.20	x		x	x	x	x
02.5	2.5	250	0.0513		9.54	x		x	x	x	x
003.	3	250	0.0427		14.0	x		x	x	x	x
004.	4	250	0.0293		28.5	x		x	x	x	x
005.	5	250	200A@250Vac 10KA@125Vac	0.0224	50.0	x		x	x	x	x
006.	6	250		0.0178	118.0	x		x	x	x	x
007.	7	250		0.0146	118.0	x		x	x	x	x
008.	8	250		0.0122	166.0	x		x	x	x	x
010.	10	250		0.0093	298.0	x		x	x	x	x
012.*	12	32		300A@32 Vac	0.0072	234.6	x	x**			x
015.*	15	32	0.0052		490.5	x	x**			x	
020.*	20	32	0.0035		1029	x	x**			x	
025.*	25	32	0.0024		2041	x	x**			x	
030.*	30	32	0.0019		3717	x	x**			x	
035.	35	32	0.0013		7531						

NOTES:

** For 318 Series 12A to 30A, the agency approval is only cURus.

Temperature Derating Curve

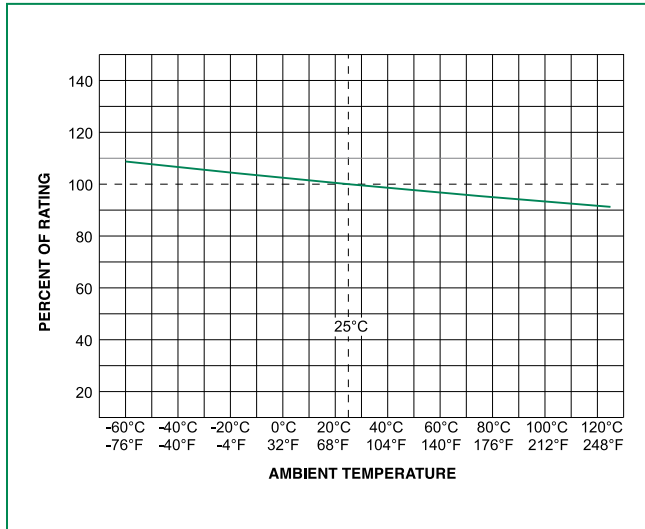

Average Time Current Curves

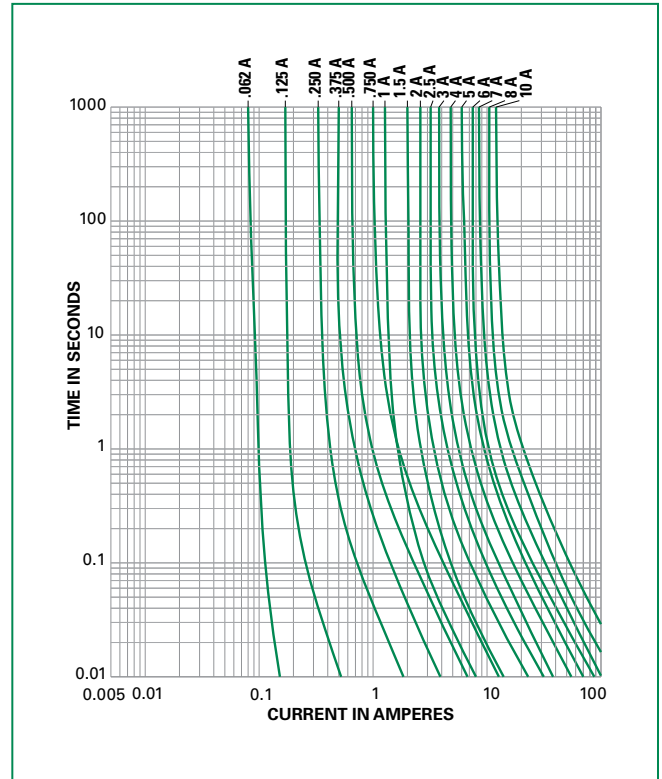

Please contact Littelfuse for more details on those T-C Curves of other ampere ratings which are not published.

Soldering Parameters - Wave Soldering

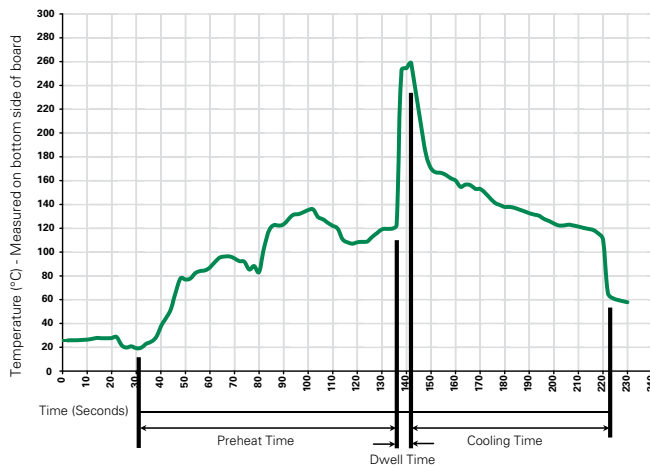

Recommended Process Parameters:

Wave Parameter	Lead-Free Recommendation
Preheat: (Depends on Flux Activation Temperature)	
Temperature Minimum:	100° C
Temperature Maximum:	150° C
Preheat Time:	60-180 seconds
Solder Pot Temperature:	260° C Maximum
Solder Dwell Time:	2-5 seconds

Recommended Hand-Solder Parameters:

Solder Iron Temperature: 350° C +/- 5° C
 Heating Time: 5 seconds max.

Note: These devices are not recommended for IR or Convection Reflow process.

Product Characteristics

Materials	Body: Glass Cap: Nickel-plated brass Leads: Tin-plated Copper
Terminal Strength	MIL-STD-202G, Method 211A, Test Condition A
Solderability	Reference IEC 60127 Second Edition 2003-01 Annex A
Product Marking	Cap1: Brand logo, current and voltage ratings Cap2: Series and agency approval marks

Operating Temperature	-55°C to +125°C
Thermal Shock	MIL-STD-202G, Method 107G, Test Condition B: (5 cycles -65°C to +125°C)
Vibration	MIL-STD-202G, Method 201 A
Humidity	MIL-STD-202G, Method 103B, Test Condition A: High RH (95%), and Elevated temperature (40°C) for 240 hours
Salt Spray	MIL-STD-202G, Method 101D, Test Condition B

Dimensions

Measurements displayed in millimeters (inches)

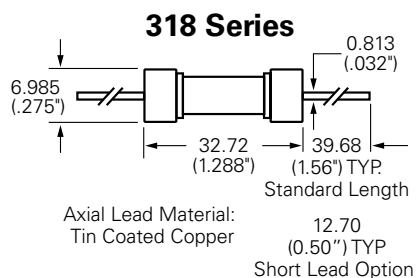
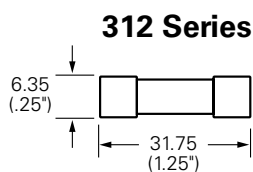

Part Numbering System

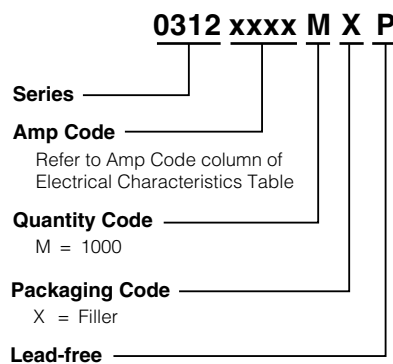

Packaging

Packaging Option	Packaging Specification	Quantity	Quantity & Packaging Code	Taping Width
312 Series				
Bulk	N/A	1000	MX	N/A
Bulk	N/A	100	HX	N/A
318 Series				
Bulk	N/A	1000	MX	N/A
Bulk	N/A	100	HX	N/A
Bulk	N/A	1000	MXB	N/A