



The **quietest**
bathroom fan.
Fact.



GH^oST™
AIR MOVEMENT
TECHNOLOGY



**NO MORE
SLEEPLESS NIGHTS.**

14.5m

An estimated 14.5m UK adults have a noisy bathroom fan in their home

1 in 4

1 in 4 UK adults describe their bathroom fan as 'annoyingly noisy'

1 in 10

More than 1 in 10 UK adults have been woken up or kept awake by a noisy bathroom fan

33%+

More than 1/3rd of the British public is affected by a chronic lack of sleep

The revolution in bathroom fans starts here.



INTRODUCING THE

Xpelair®
Simply Silent™
Contour.

Effectively eliminates humidity, condensation and odour to improve air quality in bathrooms, shower rooms, cloakrooms and toilets.

Other bathroom fans claim to be quiet. The Simply Silent™ Contour range uses advanced Ghost™ Air Movement Technology to deliver near-silent running. Plus, it's stylish, simple to install and maintain, and it comes with a two-year warranty. It's truly revolutionary.

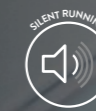

Simply Silent™

Near-silent running minimises disturbance from noisy bathroom fans for a peaceful night's sleep.



Simply Beautiful

The stylish fascia – available in square or round – blends seamlessly with the surrounding decor.



So Simple Installation

A range of smart and innovative features enables a quick, simple and hassle-free installation.



So Simple Maintenance

The sleek, smooth fascia – which acts as a protective shield against dust and grime – may be removed with ease for cleaning.



Compliant

Rest assured that the Simply Silent™ Contour range complies fully with Building Regulations Part F and Part L.



IPX4 rated

The Simply Silent™ Contour range is suitable for safe installation in bathrooms providing extra protection and peace of mind.



Two-year warranty

As a measure of our confidence, every Simply Silent™ Contour bathroom fan comes with our two-year UK warranty.

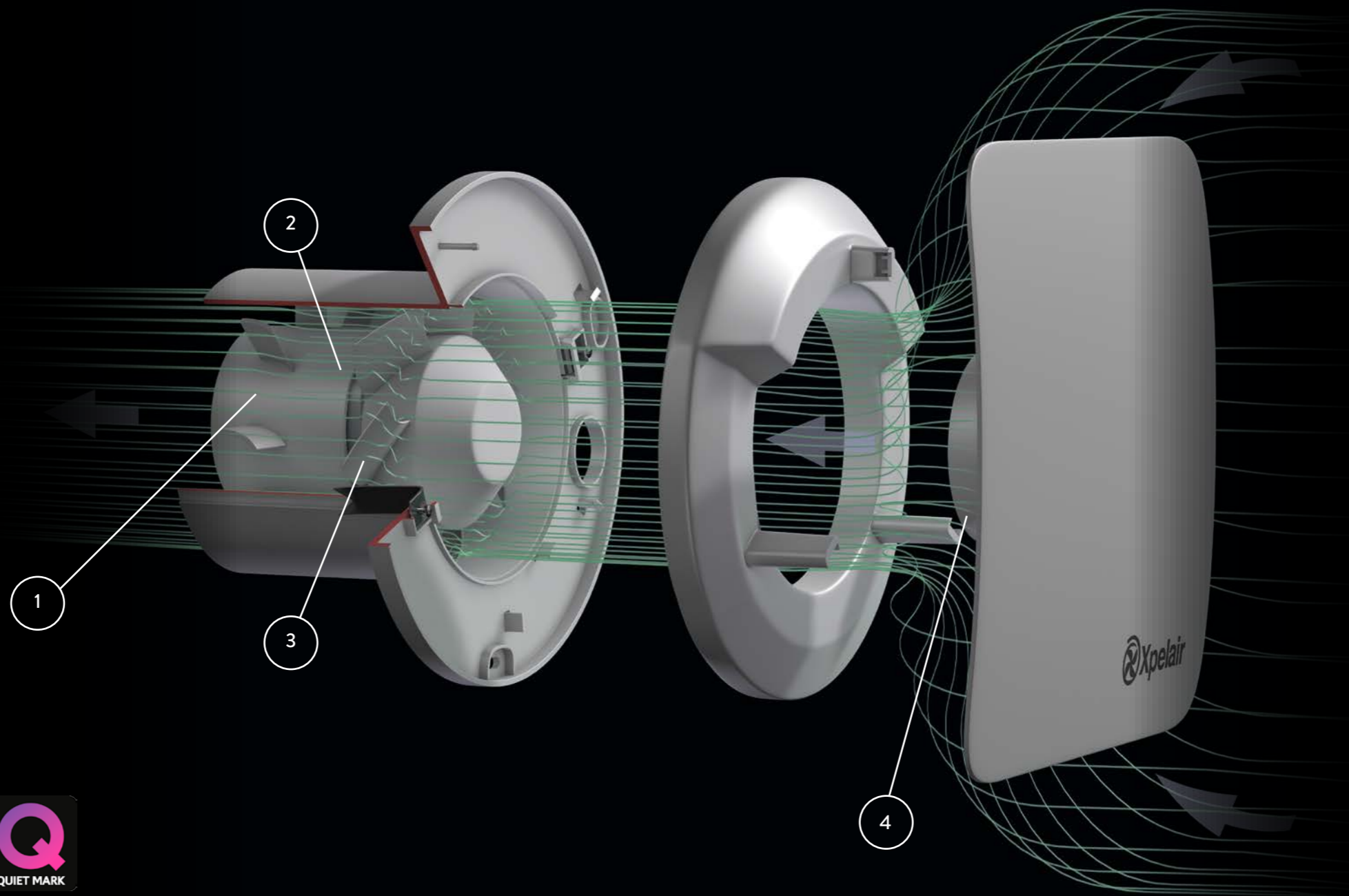

GHOST™
AIR MOVEMENT
TECHNOLOGY



Simply Silent™ With Ghost™ Air Movement Technology

The Simply Silent™ Contour range features unique, innovative Ghost™ Air Movement Technology to deliver near-silent running.

Fan noise comes from both the motor and the movement of air. To combat this, Ghost™ Air Movement Technology uses long-life silent running motors and precision engineered components to avoid all forms of mechanical noise. Advanced air flow management eliminates turbulence and irregular air flow paths within the fan.

A look inside

1

Flow straighteners guide air through the duct, **reducing turbulence.**

2

Long-life ball-bearing motors **prevent motor noise.**

3

Optimised impeller blade design, **maximising performance whilst minimising noise.**

4

A cone behind the front baffle directs air straight onto the impeller for **optimal airflow efficiency.**



Simply Beautiful

Sleek. Smooth. Subtle.

The Simply Silent™ Contour range of bathroom fans has been designed to blend seamlessly with the surrounding decor. Discover the beauty of silence.

The sleek, smooth fascia is available in interchangeable options – square or round – to suit all applications and design preferences. You won't even know it's there.



So Simple Installation

Fuss-free fitting

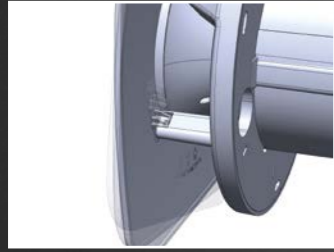

Twist and clip cover

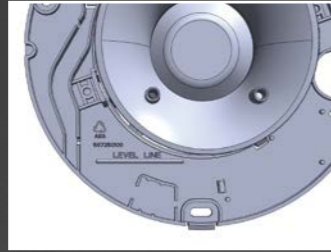

Radial fixing points and level reference line

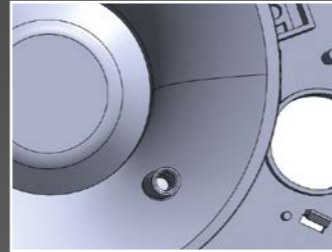

Larger cable access



Screwless hook and clip cover

The flexible Simply Silent™ Contour suits wall, ceiling, panel or window installations. So Simple Installation makes fitting quick and hassle free – wherever it's positioned.

It's all thanks to a range of clever features – like the built-in So Simple quick-fit clamp that allows the fan to be secured simply to ceilings and panels. Larger cable access slots enable easy wiring.

Three adjustable radial screw fixing points and level reference line ensure flexible and accurate fan alignment.

The duct is strengthened to avoid breakage and distortion during installation. Plus, the Simply Silent™ Contour has a hook and clip fan cover – no screws.

Simply Silent™

Wall Kit

The revolutionary Simply Silent™ wall kit allows fitting of the outer grille from the inside. Simply push the folded grille through the walltube and pull the attached string back to secure on the outside wall. Available in four different grille designs, the kit comes complete with walltube.



So Simple Maintenance

Quick and easy cleaning

The Simply Silent™ Contour range has been designed to make cleaning and servicing as simple as possible for the homeowner. We call this So Simple Maintenance.

The sleek, smooth fascia is wipe-clean – just use a cloth. Or, for a more thorough clean, a twist-and-click mechanism allows the fascia to twist off for cleaning inside. The fascia may then be cleaned in a sink. Maintenance really is So Simple.

Simply Silent™ Contour

Product information



Square



Round

MODELS

C4S	92960AW	Square intermittent bathroom fan
C4TS	92962AW	Square intermittent bathroom fan with timer
C4PS	92964AW	Square intermittent bathroom fan with pull cord
C4HTS	92966AW	Square intermittent bathroom fan with humidistat and timer

MODELS

C4R	92961AW	Round intermittent bathroom fan
C4TR	92963AW	Round intermittent bathroom fan with timer
C4PR	92965AW	Round intermittent bathroom fan with pull cord
C4HTR	92967AW	Round intermittent bathroom fan with humidistat and timer

ANCILLARIES

SSSB	92957AW	Replacement Simply Silent™ Square Baffle
SSRB	92958AW	Replacement Simply Silent™ Round Baffle
SSWKWR	92991AW	Simply Silent™ Wall Kit Round/White
SSWKWS	92992AW	Simply Silent™ Wall Kit Square/White
SSWKBR	92993AB	Simply Silent™ Wall Kit Round/Brown
SSWKBS	92994AB	Simply Silent™ Wall Kit Square/Brown (see page 8 for details)
SSWIN	92996AA	Simply Silent™ Window Kit

Simply Silent™ Contour

Technical data

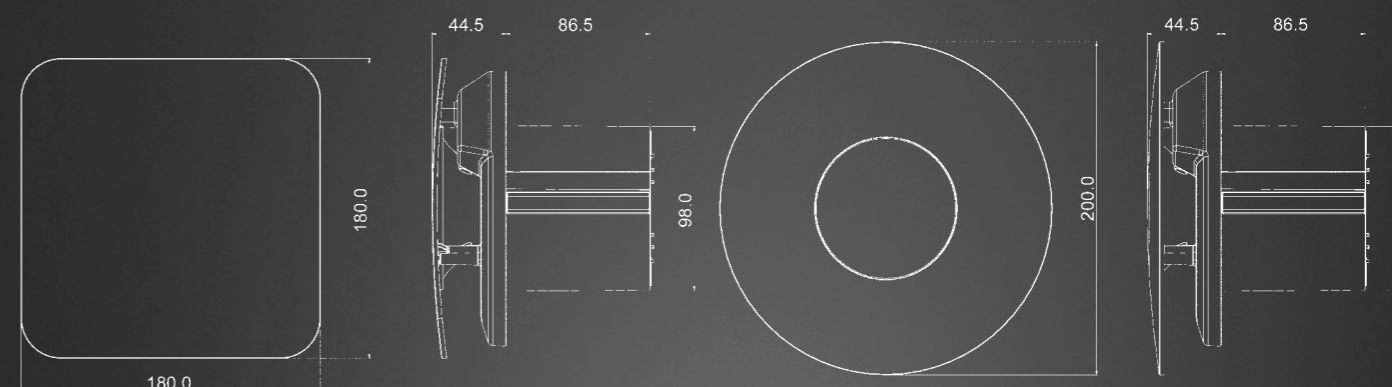

Performance

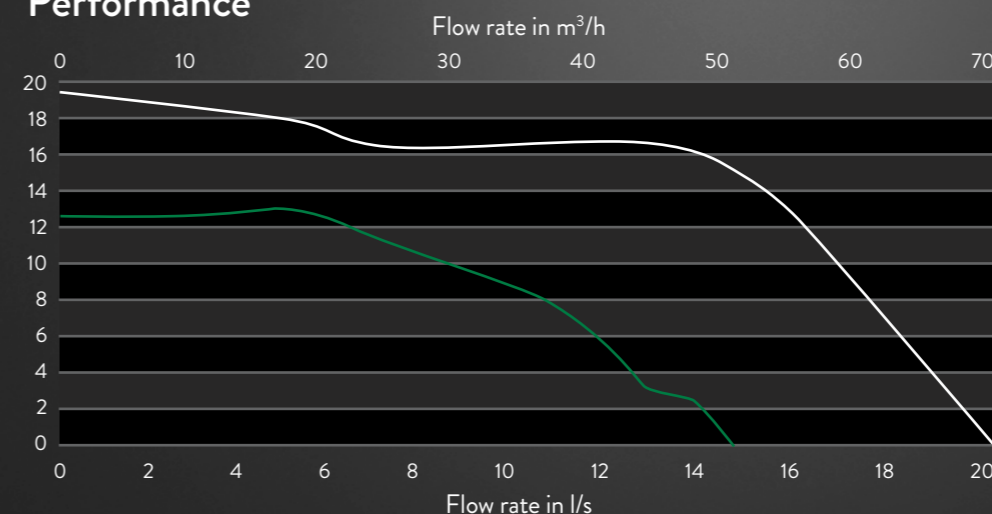

Specification

	Xpelair Simply Silent™ Contour			
	C4	C4T	C4P	C4HT
Speeds	2	2	2	2
Electrical Power Rating (W)	6.7/7.7	6.7/7.7	6.7/7.7	6.7/7.7
Extract Performance (l/s)	15/21	15/21	15/21	15/21
Specific Fan Power (SFP) (W/l/s)	0.45/0.37	0.45/0.37	0.45/0.37	0.45/0.37
Sound Pressure Level (dBA@3M)	16/29	16/29	16/29	16/29
IPX Rating	4	4	4	4

Simply Silent™ CV

Constant Volume Fan Range

4"/100mm constant volume extractor fan for the effective control of humidity, odours and mould growth in bathrooms, shower rooms, cloakrooms, toilets and kitchens.

The Simply Silent™ Contour CV combines all the benefits of the Simply Silent™ Contour with Constant Volume technology. This adjusts the speed of the fan automatically, ensuring the correct airflow. Additionally, an integral hour run meter shows exactly how long the fan has been running.



MODELS

CV4S	92968AW	Square DC constant volume bathroom fan
LVCV4S	92970AW	Square DC constant volume bathroom fan with external transformer
CV4R	92969AW	Round DC constant volume bathroom fan
LVCV4R	92971AW	Round DC constant volume bathroom fan with external transformer

UK Sales

Sales Hotline: 0844 372 7750

Sales Fax: 0844 372 7760

Sales Email: rxsalesoffice@redringxpelair.com

International Sales

Sales Hotline: +44 (0) 1733 456789

Sales Fax: +44 (0) 1733 456727

Sales Email: rxsalesoffice@redringxpelair.com

Technical Services

Service Hotline: 0844 372 7766

Service Fax: 0844 372 7767

Service Email: service.request@redringxpelair.com



GlenDimplex
NORTHERN IRELAND

Newcombe House, Newcombe Way
Orton Southgate, Peterborough
United Kingdom, PE2 6SE

t 0844 372 7761

f 0844 372 7762

www.xpelair.co.uk

5 Charlestown Avenue,
Charlestown Industrial Estate
Craigavon, Co. Armagh, BT63 5ZF

t (028) 38 337317

e sales@glendimplexni.co.uk

Improving population health and well-being with innovative and energy efficient indoor air quality and air comfort solutions.

Xpelair is a registered trademark of Redring Xpelair Group Ltd (RXG). RXG reserves the right to alter product specification or appearance without prior notice. All finishes in this brochure are as accurate as printing processes allow. Based on performance independently tested at 15l/s by ISVR June 2014.

All rights reserved.

www.xpelair.co.uk/simple-silent.html

