

### FEATURES

#### Small and thin

- 4 mm  $\times$  4 mm  $\times$  1.45 mm LFCSP package
- 3 mg resolution at 50 Hz
- Wide supply voltage range: 2.4 V to 6 V
- Low power: 350  $\mu\text{A}$  at  $V_S = 2.4\text{ V}$  (typ)
- Good zero  $g$  bias stability
- Good sensitivity accuracy
- X-axis and Y-axis aligned to within  $0.1^\circ$  (typ)
- BW adjustment with a single capacitor
- Single-supply operation
- 10,000  $g$  shock survival
- Compatible with Sn/Pb and Pb-free solder processes

### APPLICATIONS

- Vibration monitoring and compensation
- Abuse event detection
- Sports equipment

### GENERAL DESCRIPTION

The ADXL321 is a small and thin, low power, complete dual-axis accelerometer with signal conditioned voltage outputs, which is all on a single monolithic IC. The product measures acceleration with a full-scale range of  $\pm 18\text{ g}$  (typical). It can also measure both dynamic acceleration (vibration) and static acceleration (gravity).

The ADXL321's typical noise floor is  $320\ \mu\text{g}/\sqrt{\text{Hz}}$ , allowing signals below 3 mg to be resolved in tilt-sensing applications using narrow bandwidths ( $< 50\text{ Hz}$ ).

The user selects the bandwidth of the accelerometer using capacitors  $C_X$  and  $C_Y$  at the  $X_{\text{OUT}}$  and  $Y_{\text{OUT}}$  pins. Bandwidths of 0.5 Hz to 2.5 kHz may be selected to suit the application.

The ADXL321 is available in a very thin 4 mm  $\times$  4 mm  $\times$  1.45 mm, 16-lead, plastic LFCSP.

### FUNCTIONAL BLOCK DIAGRAM

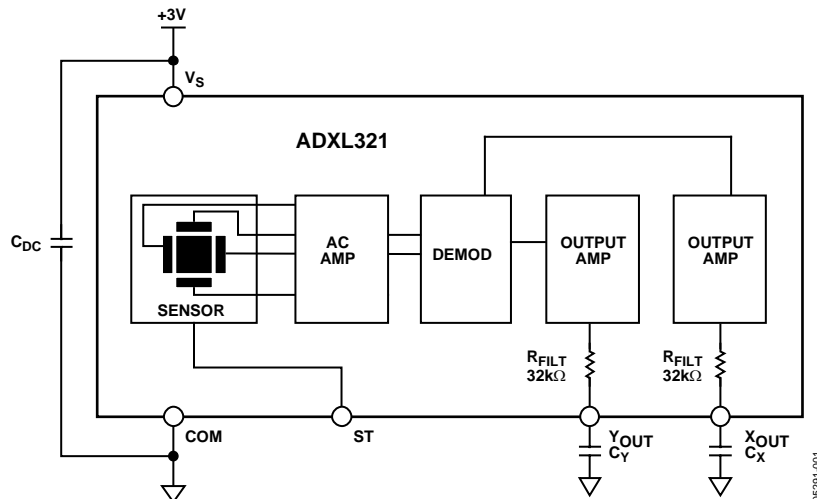

Figure 1.

#### Rev. 0

Information furnished by Analog Devices is believed to be accurate and reliable. However, no responsibility is assumed by Analog Devices for its use, nor for any infringements of patents or other rights of third parties that may result from its use. Specifications subject to change without notice. No license is granted by implication or otherwise under any patent or patent rights of Analog Devices. Trademarks and registered trademarks are the property of their respective owners.

## TABLE OF CONTENTS

Specifications.....	3	Setting the Bandwidth Using $C_X$ and $C_Y$ .....	12
Absolute Maximum Ratings.....	4	Self-Test .....	12
ESD Caution.....	4	Design Trade-Offs for Selecting Filter Characteristics: The Noise/BW Trade-Off.....	12
Pin Configuration and Function Descriptions.....	5	Use with Operating Voltages Other than 3 V.....	13
Typical Performance Characteristics ( $V_S = 3.0\text{ V}$ ) .....	7	Use as a Dual-Axis Tilt Sensor .....	13
Theory of Operation .....	11	Outline Dimensions .....	14
Performance .....	11	Ordering Guide .....	14
Applications.....	12		
Power Supply Decoupling .....	12		

## REVISION HISTORY

12/04—Revision 0: Initial Version

## SPECIFICATIONS<sup>1</sup>

T<sub>A</sub> = 25°C, V<sub>S</sub> = 3 V, C<sub>X</sub> = C<sub>Y</sub> = 0.1 μF, Acceleration = 0 g, unless otherwise noted.

Table 1.

Parameter	Conditions	Min	Typ	Max	Unit
<b>SENSOR INPUT</b>					
Measurement Range	Each axis		±18		g
Nonlinearity	% of full scale		±0.2		%
Package Alignment Error			±1		Degrees
Alignment Error	X sensor to Y sensor		±0.1		Degrees
Cross Axis Sensitivity			±2		%
<b>SENSITIVITY (RATIOMETRIC)<sup>2</sup></b>					
Sensitivity at X <sub>OUT</sub> , Y <sub>OUT</sub>	V <sub>S</sub> = 3 V	51	57	63	mV/g
Sensitivity Change due to Temperature <sup>3</sup>	V <sub>S</sub> = 3 V		0.01		%/°C
<b>ZERO g BIAS LEVEL (RATIOMETRIC)</b>					
0 g Voltage at X <sub>OUT</sub> , Y <sub>OUT</sub>	V <sub>S</sub> = 3 V	1.4	1.5	1.6	V
0 g Offset vs. Temperature			±2		mg/°C
<b>NOISE PERFORMANCE</b>					
Noise Density	@ 25°C		320		μg/√Hz rms
<b>FREQUENCY RESPONSE<sup>4</sup></b>					
C <sub>X</sub> , C <sub>Y</sub> Range <sup>5</sup>		0.002		10	μF
R <sub>FILT</sub> Tolerance			32 ± 15%		kΩ
Sensor Resonant Frequency			5.5		kHz
<b>SELF-TEST<sup>6</sup></b>					
Logic Input Low			0.6		V
Logic Input High			2.4		V
ST Input Resistance to Ground			50		kΩ
Output Change at X <sub>OUT</sub> , Y <sub>OUT</sub>	Self-test 0 to 1		18		mV
<b>OUTPUT AMPLIFIER</b>					
Output Swing Low	No load		0.3		V
Output Swing High	No load		2.6		V
<b>POWER SUPPLY</b>					
Operating Voltage Range		2.4		6	V
Quiescent Supply Current			0.49		mA
Turn-On Time <sup>7</sup>			20		ms
<b>TEMPERATURE</b>					
Operating Temperature Range		-20		+70	°C

<sup>1</sup> All minimum and maximum specifications are guaranteed. Typical specifications are not guaranteed.

<sup>2</sup> Sensitivity is essentially ratiometric to V<sub>S</sub>.

<sup>3</sup> Defined as the change from ambient-to-maximum temperature or ambient-to-minimum temperature.

<sup>4</sup> Actual frequency response controlled by user-supplied external capacitor (C<sub>X</sub>, C<sub>Y</sub>).

<sup>5</sup> Bandwidth = 1/(2 × π × 32 kΩ × C). For C<sub>X</sub>, C<sub>Y</sub> = 0.002 μF, bandwidth = 2500 Hz. For C<sub>X</sub>, C<sub>Y</sub> = 10 μF, bandwidth = 0.5 Hz. Minimum/maximum values are not tested.

<sup>6</sup> Self-test response changes cubically with V<sub>S</sub>.

<sup>7</sup> Larger values of C<sub>X</sub>, C<sub>Y</sub> increase turn-on time. Turn-on time is approximately 160 × C<sub>X</sub> or C<sub>Y</sub> + 4 ms, where C<sub>X</sub>, C<sub>Y</sub> are in μF.

## ABSOLUTE MAXIMUM RATINGS

Table 2.

Parameter	Rating
Acceleration (Any Axis, Unpowered)	10,000 <i>g</i>
Acceleration (Any Axis, Powered)	10,000 <i>g</i>
V <sub>s</sub>	-0.3 V to +7.0 V
All Other Pins	(COM - 0.3 V) to (V <sub>s</sub> + 0.3 V)
Output Short-Circuit Duration (Any Pin to Common)	Indefinite
Operating Temperature Range	-55°C to +125°C
Storage Temperature	-65°C to +150°C

Stresses above those listed under Absolute Maximum Ratings may cause permanent damage to the device. This is a stress rating only; functional operation of the device at these or any other conditions above those indicated in the operational section of this specification is not implied. Exposure to absolute maximum rating conditions for extended periods may affect device reliability.

### ESD CAUTION

ESD (electrostatic discharge) sensitive device. Electrostatic charges as high as 4000 V readily accumulate on the human body and test equipment and can discharge without detection. Although this product features proprietary ESD protection circuitry, permanent damage may occur on devices subjected to high energy electrostatic discharges. Therefore, proper ESD precautions are recommended to avoid performance degradation or loss of functionality.



## PIN CONFIGURATION AND FUNCTION DESCRIPTIONS

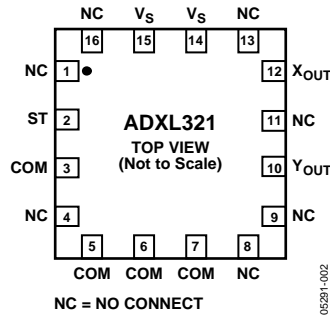

Figure 2. Pin Configuration

Table 3. Pin Function Descriptions

Pin No.	Mnemonic	Description
1, 4, 8, 9, 11, 13, 16	NC	Do Not Connect
2	ST	Self-Test
3, 5 to 7	COM	Common
10	Y <sub>OUT</sub>	Y Channel Output
12	X <sub>OUT</sub>	X Channel Output
14, 15	V <sub>S</sub>	2.4 V to 6 V

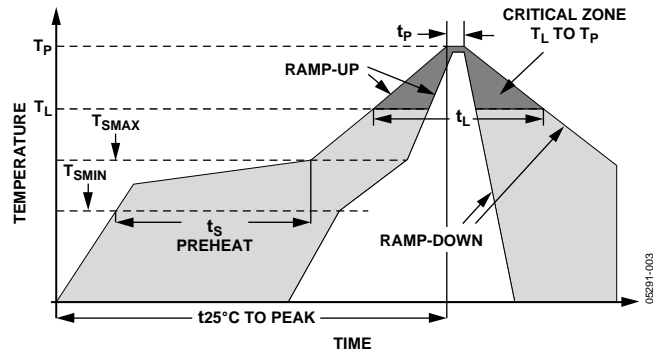

Figure 3. Recommended Soldering Profile

Table 4. Recommended Soldering Profile

Profile Feature	Sn63/Pb37	Pb-Free
Average Ramp Rate ( $T_L$ to $T_P$ )	3°C/s max	3°C/s max
Preheat		
Minimum Temperature ( $T_{SMIN}$ )	100°C	150°C
Minimum Temperature ( $T_{SMAX}$ )	150°C	200°C
Time ( $T_{SMIN}$ to $T_{SMAX}$ ), $t_s$	60 s – 120 s	60 s – 150 s
$T_{SMAX}$ to $T_L$		
Ramp-Up Rate	3°C/s	3°C/s
Time Maintained Above Liquidous ( $T_L$ )		
Liquidous Temperature ( $T_L$ )	183°C	217°C
Time ( $t_L$ )	60 s – 150 s	60 s – 150 s
Peak Temperature ( $T_P$ )	240°C + 0°C/-5°C	260°C + 0°C/-5°C
Time within 5°C of Actual Peak Temperature ( $t_p$ )	10 s – 30 s	20 s – 40 s
Ramp-Down Rate	6°C/s max	6°C/s max
Time 25°C to Peak Temperature	6 min max	8 min max

## TYPICAL PERFORMANCE CHARACTERISTICS ( $V_S = 3.0\text{ V}$ )

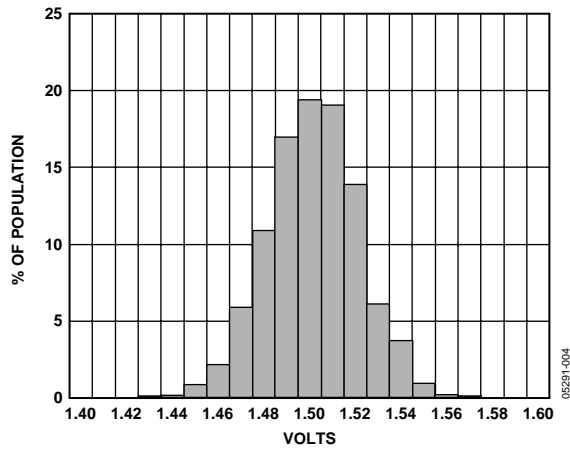

Figure 4. X-Axis Zero g Bias at 25°C

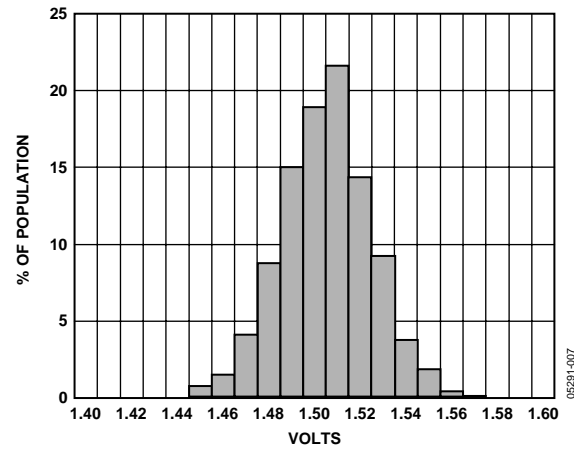

Figure 7. Y-Axis Zero g Bias at 25°C

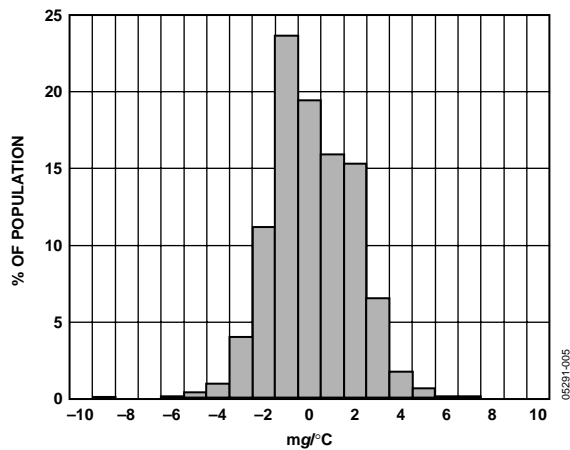

Figure 5. X-Axis Zero g Bias Temperature Coefficient

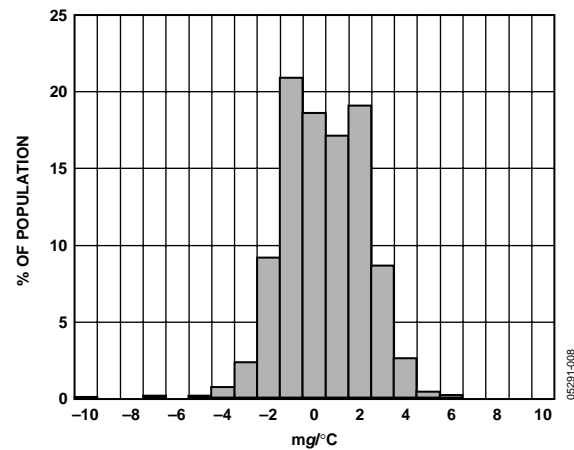

Figure 8. Y-Axis Zero g Bias Temperature Coefficient

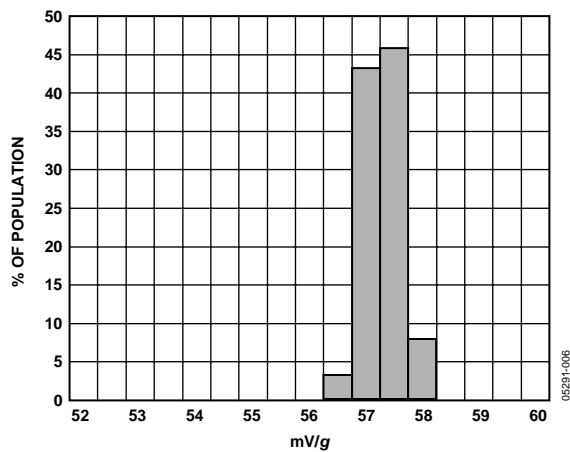

Figure 6. X-Axis Sensitivity at 25°C

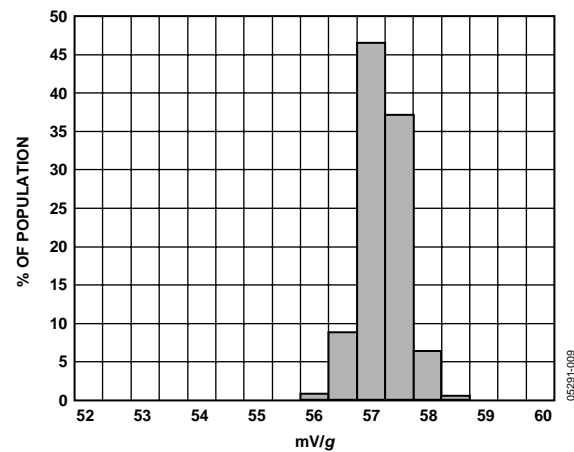

Figure 9. Y-Axis Sensitivity at 25°C

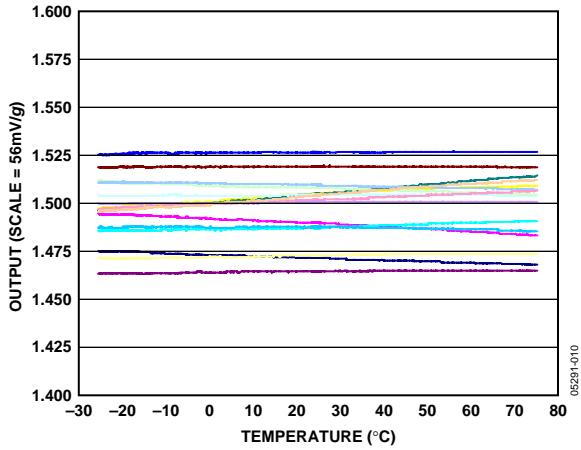

Figure 10. Zero g Bias vs. Temperature—Parts Soldered to PCB

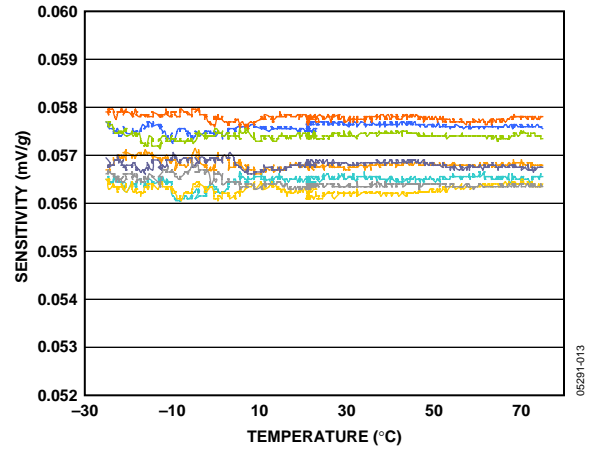

Figure 13. Sensitivity vs. Temperature—Parts Soldered to PCB

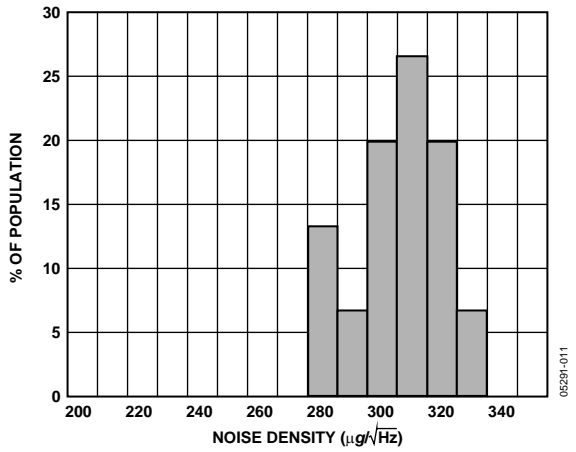

Figure 11. X-Axis Noise Density at 25°C

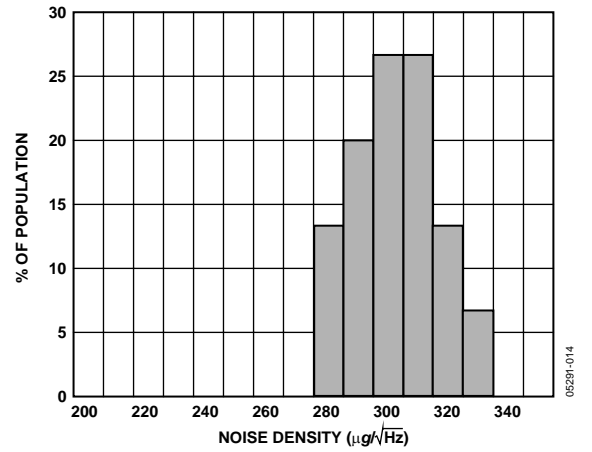

Figure 14. Y-Axis Noise Density at 25°C

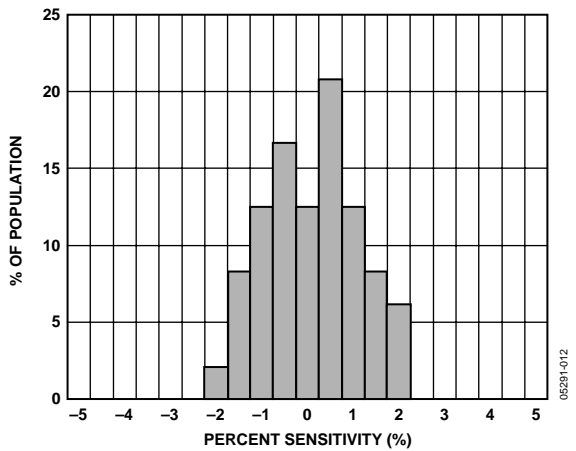

Figure 12. Z vs. X Cross-Axis Sensitivity

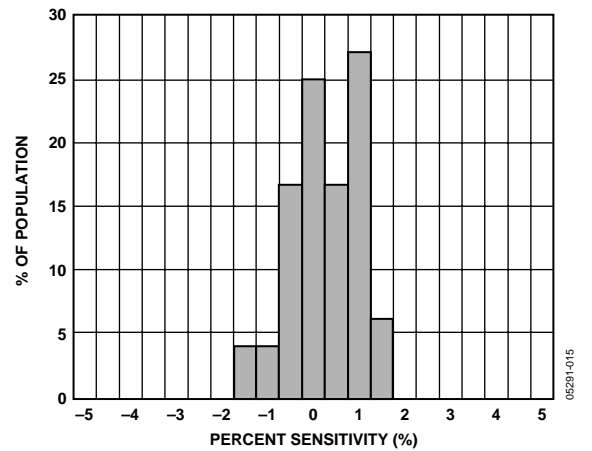

Figure 15. Z vs. Y Cross-Axis Sensitivity



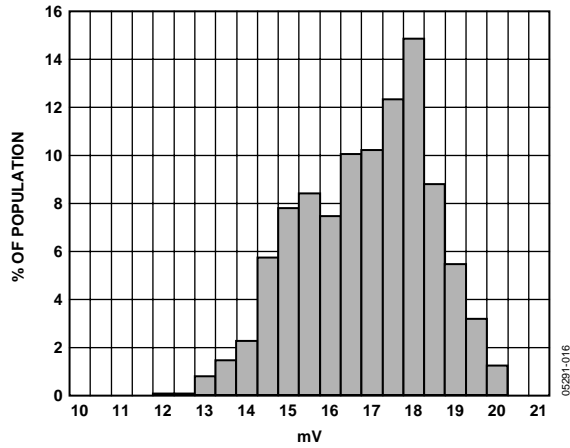

Figure 16. X-Axis Self-Test Response at 25°C

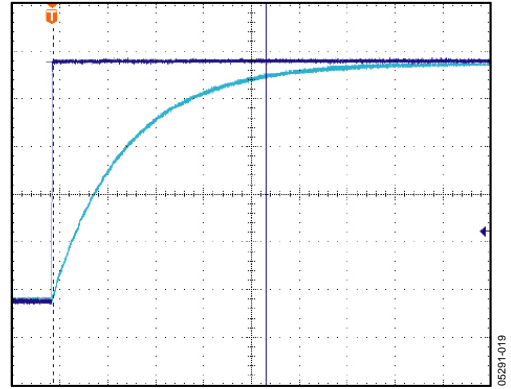

Figure 19. Turn-On Time— $C_x, C_y = 0.1 \mu F$ , Time Scale = 2 ms/DIV

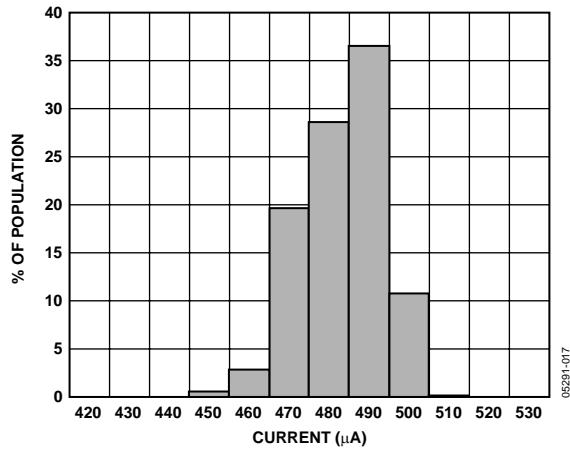

Figure 17. Supply Current at 25°C

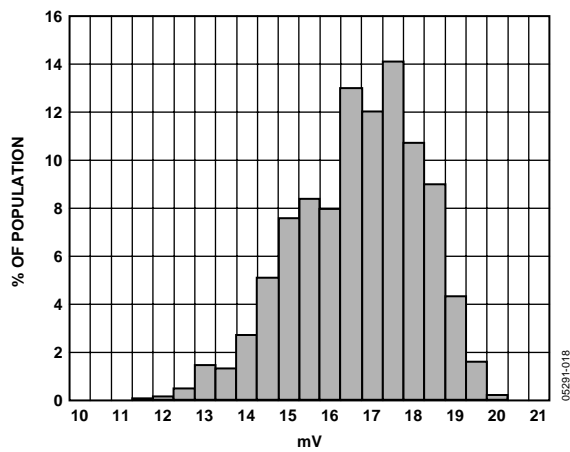

Figure 18. Y-Axis Self-Test Response at 25°C

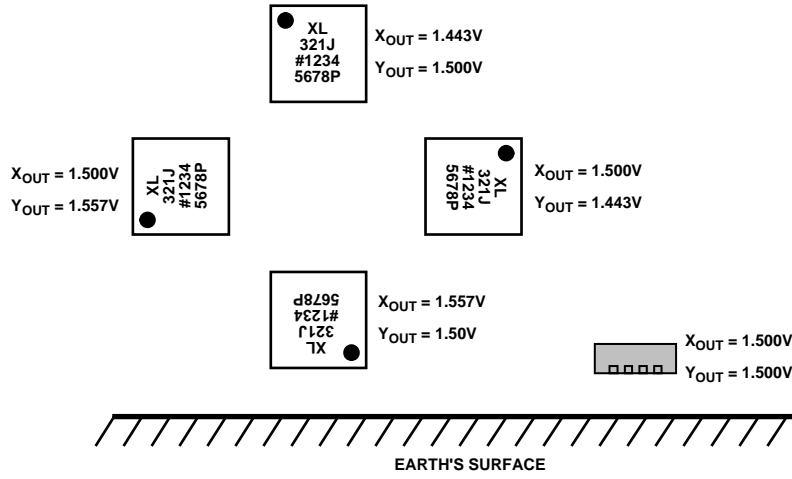

Figure 20. Output Response vs. Orientation (Top View)

## THEORY OF OPERATION

The ADXL321 is a complete acceleration measurement system on a single monolithic IC. The ADXL321 has a measurement range of  $\pm 18 g$ . It contains a polysilicon surface-micromachined sensor and signal conditioning circuitry to implement an open-loop acceleration measurement architecture. The output signals are analog voltages that are proportional to acceleration. The accelerometer measures static acceleration forces, such as gravity, which allows it to be used as a tilt sensor.

The sensor is a polysilicon surface-micromachined structure built on top of a silicon wafer. Polysilicon springs suspend the structure over the surface of the wafer and provide a resistance against acceleration forces. Deflection of the structure is measured using a differential capacitor that consists of independent fixed plates and plates attached to the moving mass. The fixed plates are driven by  $180^\circ$  out-of-phase square waves. Acceleration deflects the beam and unbalances the differential capacitor, resulting in an output square wave whose amplitude is proportional to acceleration. Phase-sensitive demodulation techniques are then used to rectify the signal and determine the direction of the acceleration.

The demodulator's output is amplified and brought off-chip through a  $32 k\Omega$  resistor. The user then sets the signal bandwidth of the device by adding a capacitor. This filtering improves measurement resolution and helps prevent aliasing.

## PERFORMANCE

Rather than using additional temperature compensation circuitry, innovative design techniques have been used to ensure high performance is built-in. As a result, there is neither quantization error nor nonmonotonic behavior, and temperature hysteresis is very low (typically less than  $10 mg$  over the  $-20^\circ C$  to  $+70^\circ C$  temperature range).

Figure 10 shows the zero  $g$  output performance of eight parts (X- and Y-axis) over a  $-20^\circ C$  to  $+70^\circ C$  temperature range.

Figure 13 demonstrates the typical sensitivity shift over temperature for supply voltages of  $3 V$ . This is typically better than  $\pm 1\%$  over the  $-20^\circ C$  to  $+70^\circ C$  temperature range.

## APPLICATIONS

### POWER SUPPLY DECOUPLING

For most applications, a single 0.1  $\mu\text{F}$  capacitor,  $C_{\text{DC}}$ , adequately decouples the accelerometer from noise on the power supply. However, in some cases, particularly where noise is present at the 140 kHz internal clock frequency (or any harmonic thereof), noise on the supply may cause interference on the ADXL321 output. If additional decoupling is needed, a 100  $\Omega$  (or smaller) resistor or ferrite bead may be inserted in the supply line. Additionally, a larger bulk bypass capacitor (in the 1  $\mu\text{F}$  to 4.7  $\mu\text{F}$  range) may be added in parallel to  $C_{\text{DC}}$ .

### SETTING THE BANDWIDTH USING $C_X$ AND $C_Y$

The ADXL321 has provisions for band-limiting the  $X_{\text{OUT}}$  and  $Y_{\text{OUT}}$  pins. Capacitors must be added at these pins to implement low-pass filtering for antialiasing and noise reduction. The equation for the 3 dB bandwidth is

$$F_{-3\text{dB}} = 1/(2\pi(32\text{ k}\Omega) \times C_{(X, Y)})$$

or more simply,

$$F_{-3\text{dB}} = 5\ \mu\text{F}/C_{(X, Y)}$$

The tolerance of the internal resistor ( $R_{\text{FILT}}$ ) typically varies as much as  $\pm 15\%$  of its nominal value (32 k $\Omega$ ), and the bandwidth varies accordingly. A minimum capacitance of 2000 pF for  $C_X$  and  $C_Y$  is required in all cases.

**Table 5. Filter Capacitor Selection,  $C_X$  and  $C_Y$**

Bandwidth (Hz)	Capacitor ( $\mu\text{F}$ )
1	4.7
10	0.47
50	0.10
100	0.05
200	0.027
500	0.01

### SELF-TEST

The ST pin controls the self-test feature. When this pin is set to  $V_S$ , an electrostatic force is exerted on the accelerometer beam. The resulting movement of the beam allows the user to test if the accelerometer is functional. The typical change in output is 315 mg (corresponding to 18 mV). This pin may be left open-circuit or connected to common (COM) in normal use.

The ST pin should never be exposed to voltages greater than  $V_S + 0.3\text{ V}$ . If this cannot be guaranteed due to the system design (for instance, if there are multiple supply voltages), then a low  $V_F$  clamping diode between ST and  $V_S$  is recommended.

### DESIGN TRADE-OFFS FOR SELECTING FILTER CHARACTERISTICS: THE NOISE/BW TRADE-OFF

The accelerometer bandwidth selected ultimately determines the measurement resolution (smallest detectable acceleration). Filtering can be used to lower the noise floor, which improves the resolution of the accelerometer. Resolution is dependent on the analog filter bandwidth at  $X_{\text{OUT}}$  and  $Y_{\text{OUT}}$ .

The output of the ADXL321 has a typical bandwidth of 2.5 kHz. The user must filter the signal at this point to limit aliasing errors. The analog bandwidth must be no more than half the A/D sampling frequency to minimize aliasing. The analog bandwidth may be further decreased to reduce noise and improve resolution.

The ADXL321 noise has the characteristics of white Gaussian noise, which contributes equally at all frequencies and is described in terms of  $\mu\text{g}/\sqrt{\text{Hz}}$  (the noise is proportional to the square root of the accelerometer's bandwidth). The user should limit bandwidth to the lowest frequency needed by the application in order to maximize the resolution and dynamic range of the accelerometer.

With the single-pole, roll-off characteristic, the typical noise of the ADXL321 is determined by

$$rmsNoise = (320\ \mu\text{g}/\sqrt{\text{Hz}}) \times (\sqrt{\text{BW} \times 1.6})$$

At 100 Hz bandwidth the noise will be

$$rmsNoise = (320\ \mu\text{g}/\sqrt{\text{Hz}}) \times (\sqrt{100 \times 1.6}) = 4\text{ mg}$$

Often, the peak value of the noise is desired. Peak-to-peak noise can only be estimated by statistical methods. A factor of 6 is generally used to convert rms to peak-to-peak. Table 6 is useful for estimating the probabilities of exceeding various peak values, given the rms value.

**Table 6. Estimation of Peak-to-Peak Noise**

Peak-to-Peak Value	% of Time That Noise Exceeds Nominal Peak-to-Peak Value
$2 \times rms$	32
$4 \times rms$	4.6
$6 \times rms$	0.27
$8 \times rms$	0.006

Peak-to-peak noise values give the best estimate of the uncertainty in a single measurement. Table 7 gives the typical noise output of the ADXL321 for various  $C_X$  and  $C_Y$  values.

**Table 7. Filter Capacitor Selection ( $C_X$ ,  $C_Y$ )**

Bandwidth (Hz)	$C_X$ , $C_Y$ ( $\mu\text{F}$ )	RMS Noise (mg)	Peak-to-Peak Noise Estimate (mg)
10	0.47	1.3	7.8
50	0.1	2.9	17.4
100	0.047	4	24
500	0.01	9.1	54.6

### USE WITH OPERATING VOLTAGES OTHER THAN 3 V

The ADXL321 is tested and specified at  $V_S = 3\text{ V}$ ; however, it can be powered with  $V_S$  as low as 2.4 V or as high as 6 V. Note that some performance parameters change as the supply voltage is varied.

The ADXL321 output is ratiometric, so the sensitivity (or scale factor) varies proportionally to supply voltage. At  $V_S = 5\text{ V}$ , the sensitivity is typically 100 mV/g. At  $V_S = 2.4\text{ V}$ , the sensitivity is typically 45 mV/g.

The zero g bias output is also ratiometric, so the zero g output is nominally equal to  $V_S/2$  at all supply voltages.

The output noise is not ratiometric but is absolute in volts; therefore, the noise density decreases as the supply voltage increases. This is because the scale factor (mV/g) increases while the noise voltage remains constant. At  $V_S = 5\text{ V}$ , the noise density is typically  $190\ \mu\text{g}/\sqrt{\text{Hz}}$ , while at  $V_S = 2.4\text{ V}$ , the noise density is typically  $400\ \mu\text{g}/\sqrt{\text{Hz}}$ .

Self-test response in g is roughly proportional to the square of the supply voltage. However, when ratiometricity of sensitivity is factored in with supply voltage, the self-test response in volts is roughly proportional to the cube of the supply voltage. For example, at  $V_S = 5\text{ V}$ , the self-test response for the ADXL321 is approximately 80 mV. At  $V_S = 2.4\text{ V}$ , the self-test response is approximately 8 mV.

The supply current decreases as the supply voltage decreases. Typical current consumption at  $V_S = 5\text{ V}$  is 750  $\mu\text{A}$ , and typical current consumption at  $V_S = 2.4\text{ V}$  is 350  $\mu\text{A}$ .

### USE AS A DUAL-AXIS TILT SENSOR

An accelerometer is most sensitive to tilt when its sensitive axis is perpendicular to the force of gravity (that is, when it is parallel to the earth's surface). At this orientation, its sensitivity to changes in tilt is highest. When the accelerometer is oriented on axis to gravity (near its +1 g or -1 g reading), the change in output acceleration per degree of tilt is negligible. When the accelerometer is perpendicular to gravity, its output changes nearly 17.5 mg per degree of tilt. At 45°, its output changes at only 12.2 mg per degree of tilt, and resolution declines.

#### Converting Acceleration to Tilt

When the accelerometer is oriented so both its X-axis and Y-axis are parallel to the earth's surface, it can be used as a 2-axis tilt sensor with both a roll axis and pitch axis. Once the output signal from the accelerometer has been converted to an acceleration that varies between -1 g and +1 g, the output tilt in degrees is calculated as

$$PITCH = \arcsine(A_X/1\text{ g})$$

$$ROLL = \arcsine(A_Y/1\text{ g})$$

Be sure to account for overranges. It is possible for the accelerometers to output a signal greater than  $\pm 1\text{ g}$  due to vibration, shock, or other accelerations.

## OUTLINE DIMENSIONS

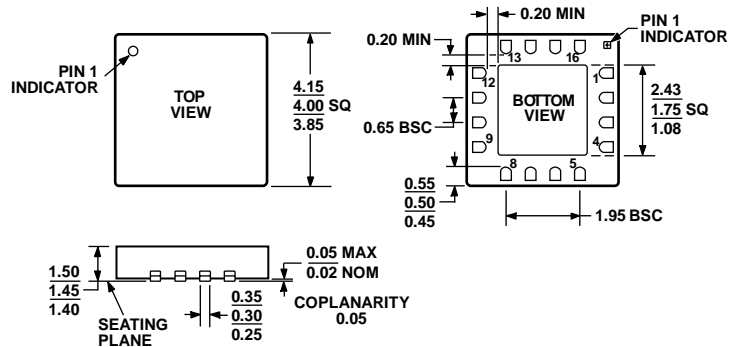

\*STACKED DIE WITH GLASS SEAL.

Figure 21. 16-Lead Lead Frame Chip Scale Package [MQ\_LFCSP\_LQ]  
 4 mm × 4 mm Body, Thick Quad  
 (CP-16-5a\*)  
 Dimensions shown in millimeters  
 (Drawing Not to Scale)

072606-A

## ORDERING GUIDE

Model	Measurement Range	Specified Voltage (V)	Temperature Range	Package Description	Package Option
ADXL321JCP <sup>1</sup>	±18 g	3	−20°C to +70°C	16-Lead LFCSP_LQ	CP-16-5a
ADXL321JCP-REEL	±18 g	3	−20°C to +70°C	16-Lead LFCSP_LQ	CP-16-5a
ADXL321EB				Evaluation Board	

<sup>1</sup> Lead finish—Matte tin.

**NOTES**

**ADXL321**

**NOTES**