

SMD Power Inductor CDRH127/LD



Description

- Ferrite drum core construction.
- Magnetically shielded.
- L × W × H: 12.3 × 12.3 × 8.0 mm Max.
- Product weight: 3.6g(Ref.)
- Moisture Sensitivity Level: 1
- RoHS compliance.

Environmental Data

- Operating temperature range: -40°C ~ +100°C (including coil's self temperature rise)
- Storage temperature range: -40°C ~ +100°C
- Solder reflow temperature: 260 °C peak.

Packaging

- Carrier tape and reel packaging
- 13" diameter reel
- 500pcs per reel

Applications

- Ideally used in Notebook PC, LCD TV, DVD, Game machine, STB, Projector etc as DC-DC converter inductors.

Dimension - [mm]

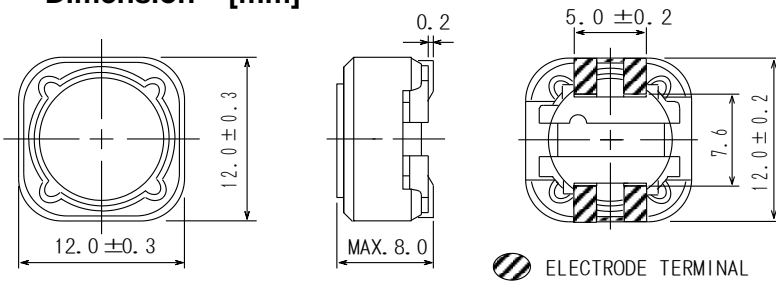

Land pattern and Schematics - [mm]

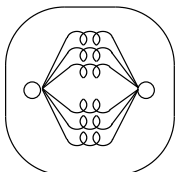
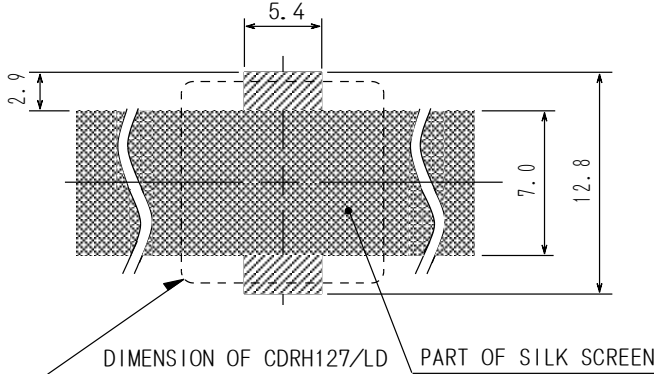

1.0 μ H

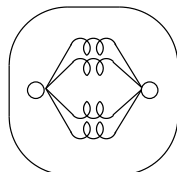

2.4 μ H ~ 56 μ H

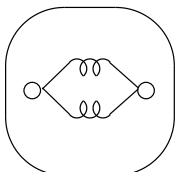

68 μ H ~ 150 μ H

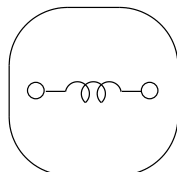

180 μ H ~ 1 mH



Electrical Characteristics

Part Name	Stamp	Inductance (μH) [within] ※1	D.C.R.(Ω) Max. (Typ.) (at 20°C)	Rated Current (A) ※2
CDRH127/LDNP-1R0NC	1R0	1.0 \pm 30%	6.5m(5.0m)	14.0
CDRH127/LDNP-2R4NC	2R4	2.4 \pm 30%	10.5m(8.1m)	10.3
CDRH127/LDNP-3R5NC	3R5	3.5 \pm 30%	12.4m(9.5m)	9.30
CDRH127/LDNP-4R6NC	4R6	4.6 \pm 30%	13.8m(10.6m)	9.10
CDRH127/LDNP-5R8NC	5R8	5.8 \pm 30%	16.2m(12.4m)	8.60
CDRH127/LDNP-7R4NC	7R4	7.4 \pm 30%	17.7m(13.6m)	7.40
CDRH127/LDNP-100MC	100	10 \pm 20%	19.5m(15.0m)	6.70
CDRH127/LDNP-120MC	120	12 \pm 20%	21.3m(16.4m)	6.45
CDRH127/LDNP-150MC	150	15 \pm 20%	26.4m(20.3m)	5.65
CDRH127/LDNP-180MC	180	18 \pm 20%	28.0m(21.5m)	5.10
CDRH127/LDNP-220MC	220	22 \pm 20%	36.4m(28.0m)	4.70
CDRH127/LDNP-270MC	270	27 \pm 20%	41.6m(32.0m)	4.20
CDRH127/LDNP-330MC	330	33 \pm 20%	53.3m(41.0m)	3.90
CDRH127/LDNP-390MC	390	39 \pm 20%	60.5m(46.5m)	3.50
CDRH127/LDNP-470MC	470	47 \pm 20%	78.0m(60.0m)	3.25
CDRH127/LDNP-560MC	560	56 \pm 20%	90.0m(69.0m)	2.90
CDRH127/LDNP-680MC	680	68 \pm 20%	120m(92.0m)	2.60
CDRH127/LDNP-820MC	820	82 \pm 20%	119m(91.0m)	2.40
CDRH127/LDNP-101MC	101	100 \pm 20%	151m (119m)	2.10
CDRH127/LDNP-121MC	121	120 \pm 20%	169m (130m)	1.90
CDRH127/LDNP-151MC	151	150 \pm 20%	227m (174m)	1.80
CDRH127/LDNP-181MC	181	180 \pm 20%	299m (230m)	1.55
CDRH127/LDNP-221MC	221	220 \pm 20%	338m (260m)	1.45
CDRH127/LDNP-271MC	271	270 \pm 20%	419m (322m)	1.30
CDRH127/LDNP-331MC	331	330 \pm 20%	471m (362m)	1.20
CDRH127/LDNP-391MC	391	390 \pm 20%	572m (440m)	1.10
CDRH127/LDNP-471MC	471	470 \pm 20%	741m (570m)	1.00
CDRH127/LDNP-561MC	561	560 \pm 20%	852m (655m)	0.95
CDRH127/LDNP-681MC	681	680 \pm 20%	1.13 (870m)	0.85
CDRH127/LDNP-821MC	821	820 \pm 20%	1.24 (950m)	0.75
CDRH127/LDNP-102MC	102	1000 \pm 20%	1.50 (1.15)	0.70

※1. Inductance Measuring condition: at 100 kHz.

※2. Rated current: The DC current at which the inductance decreases to 75% of its nominal value or when $\Delta t=40^\circ\text{C}$, whichever is lower .

SMD Power Inductor CDRH127/LD



Saturation Current & Temperature Rise Graph

— L (20°C) — L (100°C) — ΔT

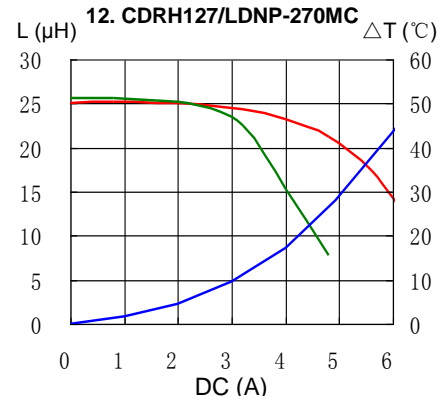
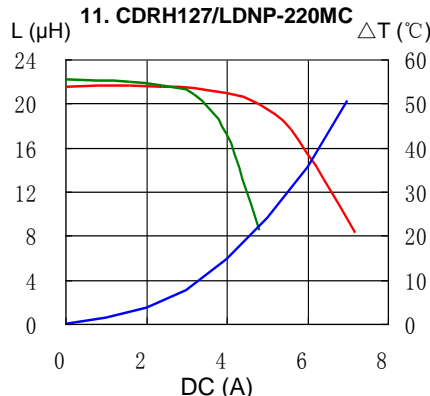
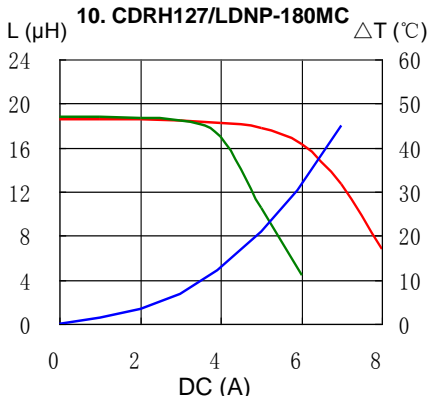
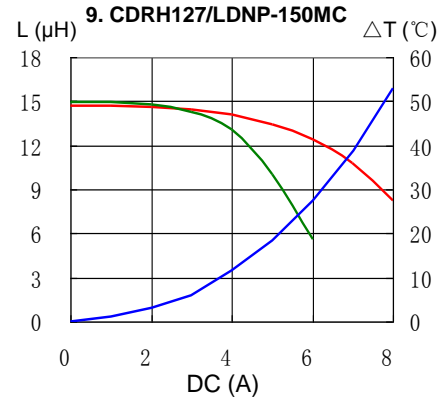
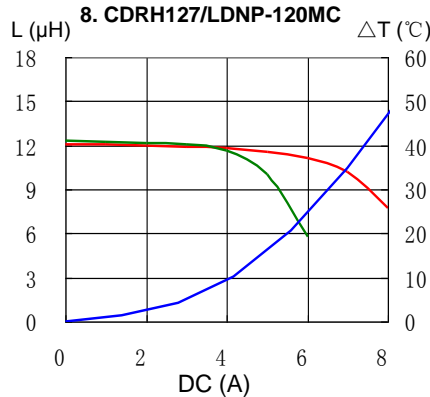
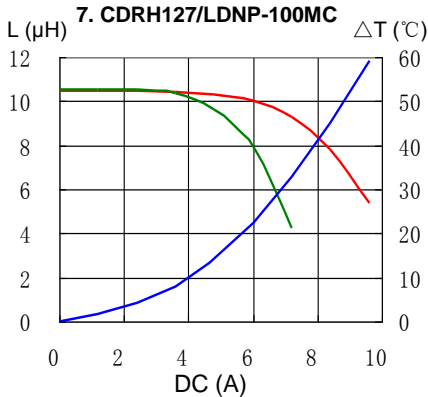
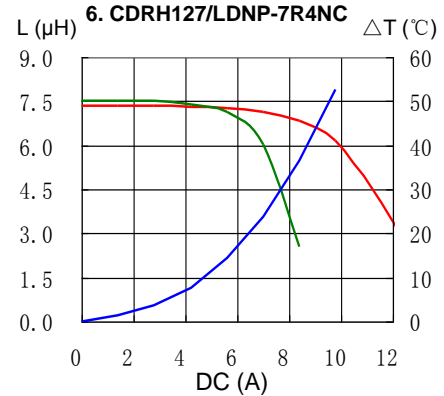
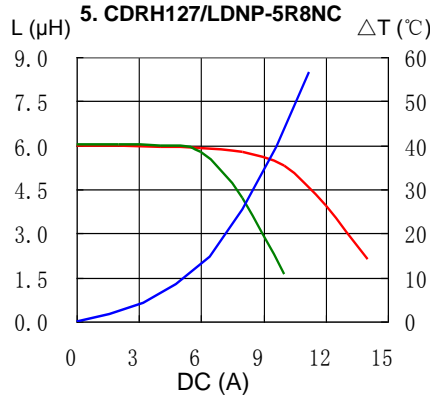
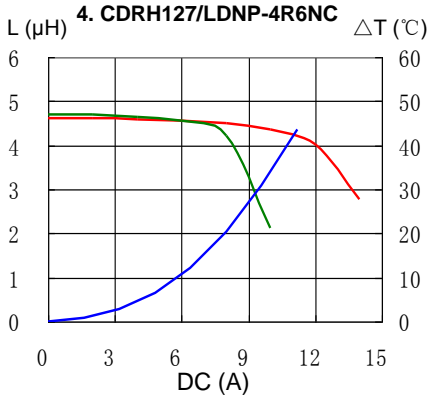
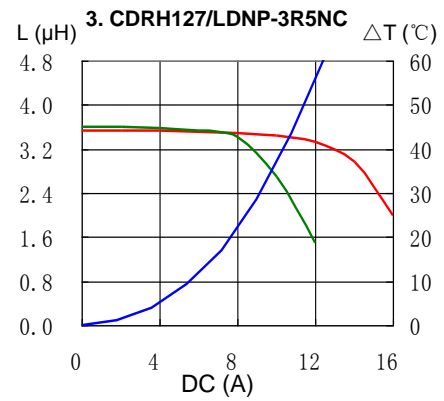
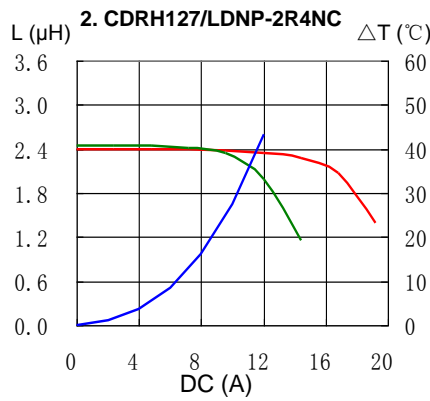
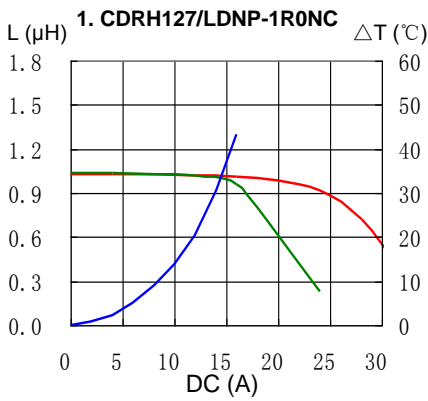

SMD Power Inductor CDRH127/LD



Saturation Current & Temperature Rise Graph

— L (20°C) — L (100°C) — ΔT

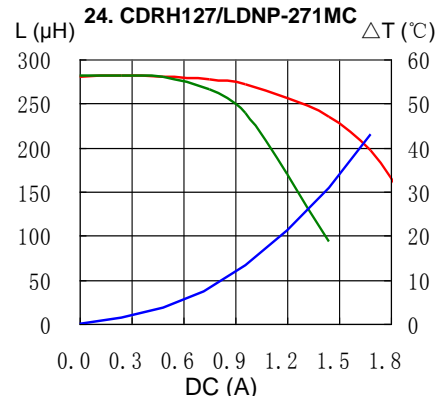
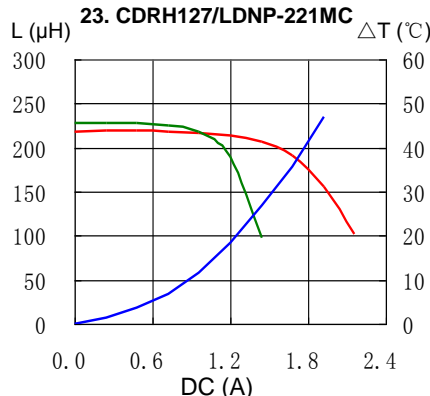
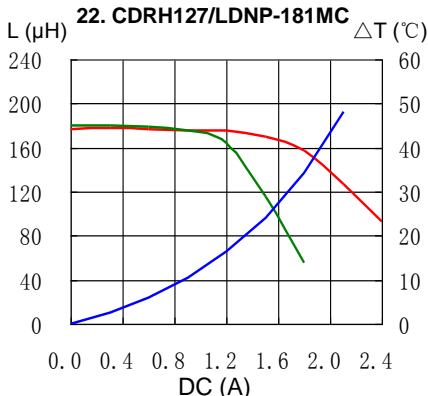
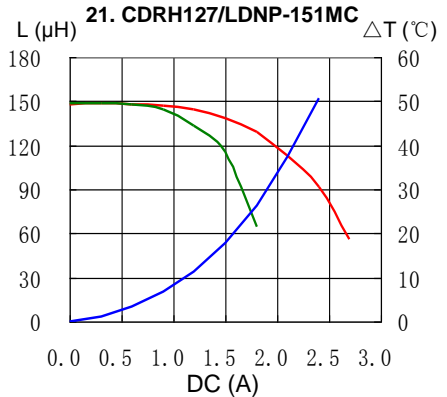
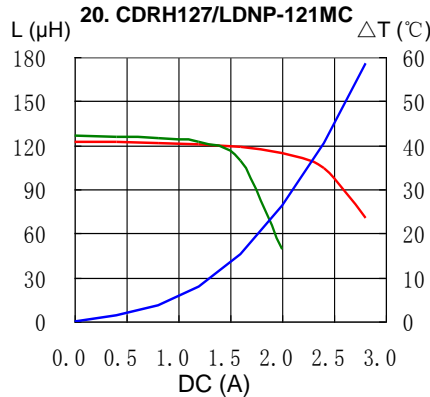
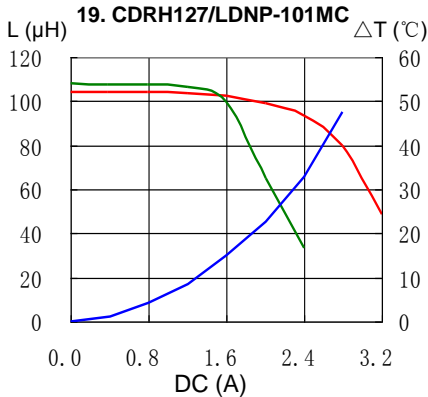
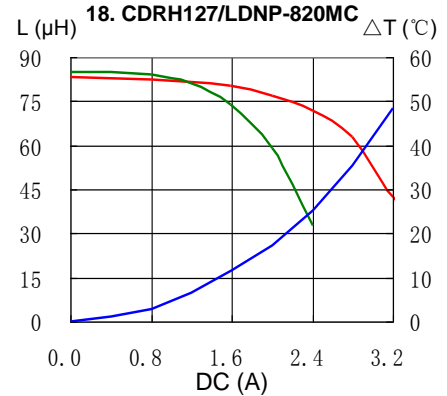
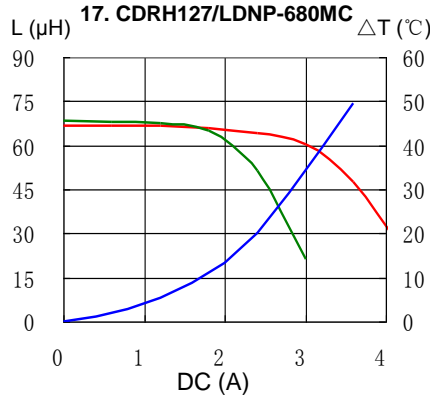
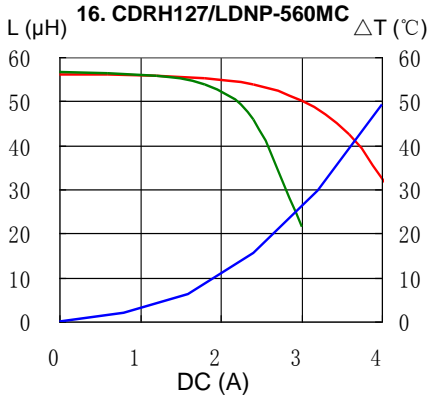
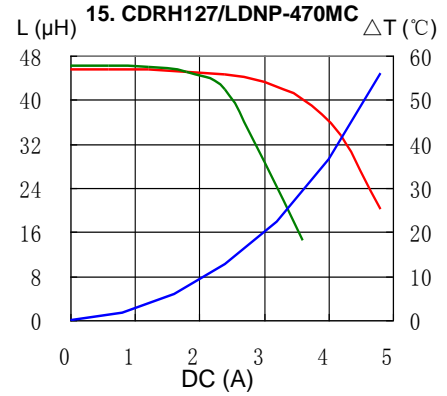
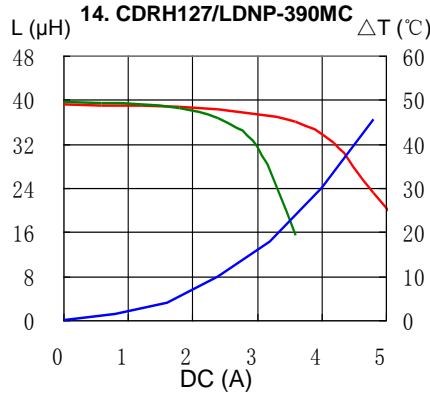
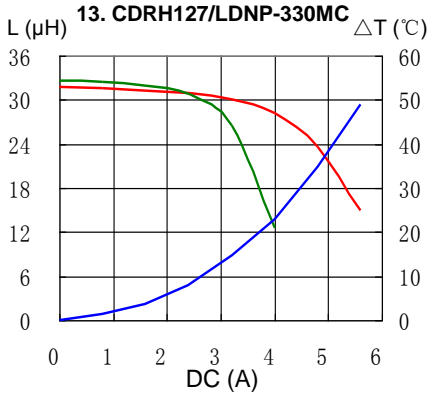

SMD Power Inductor CDRH127/LD



Saturation Current & Temperature Rise Graph

— L (20°C) — L (100°C) — ΔT

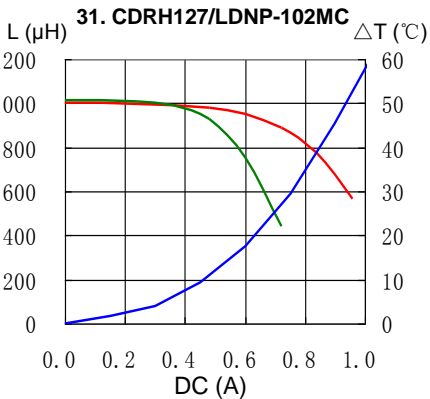
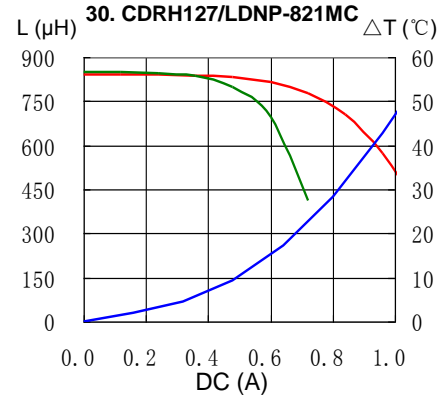
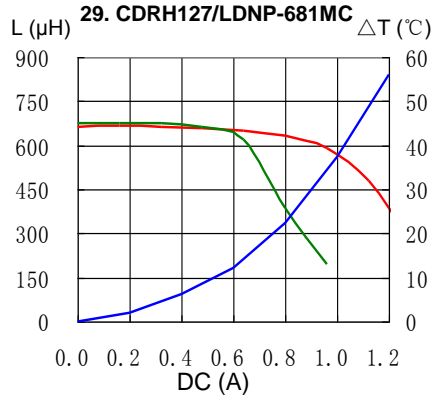
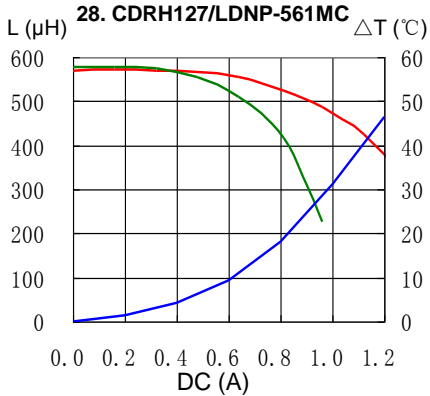
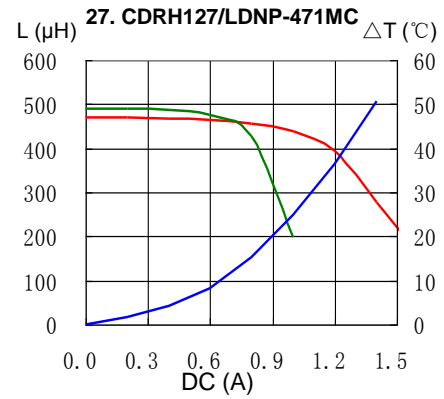
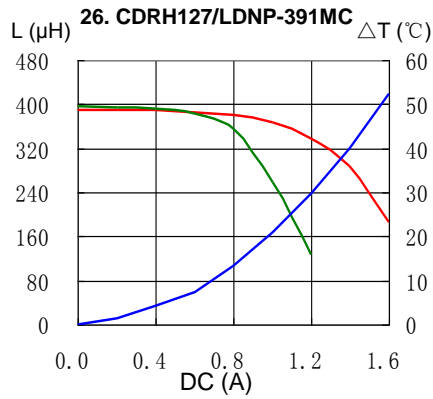
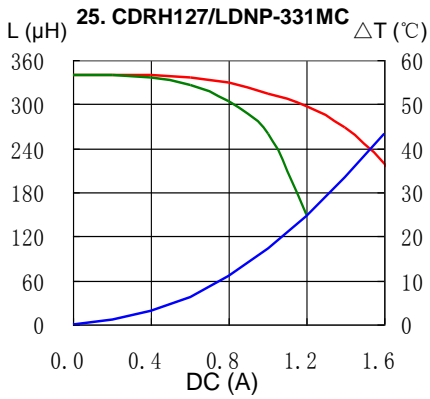

SMD Power Inductor CDRH127/LD

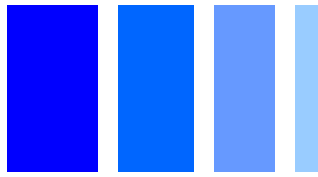

Solder Reflow Condition

Heat Endurance

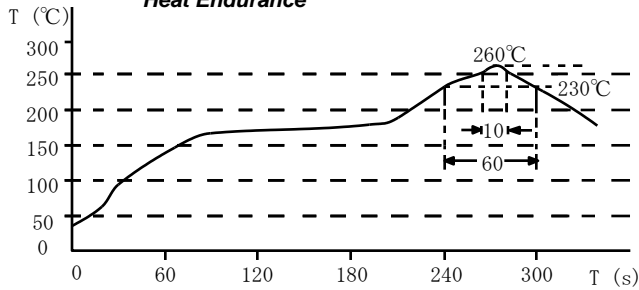

Temperature Chart

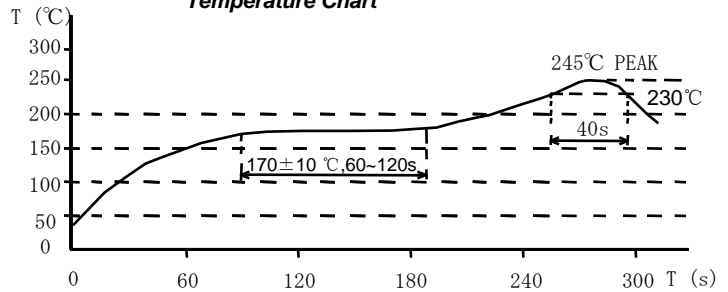

Please refer to the sales offices on our website - <http://www.sumida.com>

Hong Kong

Tel.+852-2880-6781
FAX.+852-2565-9600
sales@hk.sumida.com

Saitama(Japan)

Tel.+81-48-691-7300
FAX.+81-48-691-7340
sales@jp.sumida.com

Chicago

Tel.+1-847-545-6700
FAX. +1-847-545-6720
sales@us.sumida.com

Shanghai

Tel.+86-21-5836-3299
FAX.+86-21-5836-3266
shanghai.sales@cn.sumida.com

Seoul

Tel.+82-2-6237-0777
FAX.+82-2-6237-0778
sales@kr.sumida.com

Obernzell

Tel.+49-8591-937-0
FAX. +49-8591-937-103
contact@eu.sumida.com

Shenzhen

Tel.+86-755-8291-0228
FAX.+86-755-8291-0338
shenzhen.sales@cn.sumida.com

Singapore

Tel.+65-6296-3388
FAX.+65-6841-4426
sales@sg.sumida.com

Neumarkt

Tel.+49-9181-4509-110
FAX. +49-9181-4509-310
infocomp@eu.sumida.com

Taipei

Tel.+886-2-8751-2737
FAX.+886-2-8751-2738
sales@tw.sumida.com

San Jose

Tel.+1-408-321-9660
FAX.+1-408-321-9308
sales@us.sumida.com