

# 0.95V to $V_{CC}-1V$ , 0.5A/1.0A/2.0A 1ch Ultra Low Dropout Linear Regulators

BD3550HFN BD3551HFN BD3552HFN

## General Description

BD3550HFN, BD3551HFN and BD3552HFN are ultra low-dropout linear chipset regulators that operate from a very low input supply. They offer ideal performance in low input voltage to low output voltage applications. The input-to-output voltage difference is minimized by using a built-in N-Channel power MOSFET with a maximum ON-Resistance of  $R_{ON}=100m\Omega$ (Typ) <BD3552HFN>. By lowering the dropout voltage, the regulator realizes high output current ( $I_{OUTMAX}=2.0A$  <BD3552HFN>) thereby, reducing conversion loss, making it comparable to a switching regulator and its power transistor, choke coil, and rectifier diode constituents. The BD3550HFN, BD3551HFN, BD3552HFN are available in significantly downsized package profiles and allow low-cost design. An external resistor allows the entire range of output voltage configurations between 0.65V and 2.7V, while the NRCS (soft start) function enables a controlled output voltage ramp-up, which can be programmed to a required power supply sequence.

## Features

- Internal High-Precision Reference Voltage Circuit (0.65V $\pm$ 1%)
- Built-in VCC Undervoltage Lockout Circuit
- NRCS (soft start) Function Reduces the Magnitude of In-rush Current
- Internal N-Channel MOSFET
- Built-in Current Limit Circuit
- Built-in Thermal Shutdown (TSD) Circuit
- Tracking Function

## Applications

Notebook computers, Desktop computers, LCD-TV, DVD, Digital appliances

## Lineup

Maximum Output Current	ON-Resistance(Typ)	Package	$V_{CC}=5V$
0.5A	400m $\Omega$	HSON8	BD3550HFN
1.0A	200m $\Omega$		BD3551HFN
2.0A	100m $\Omega$		BD3552HFN

## Key Specifications

- IN Input Voltage Range: 0.95V to  $V_{CC}-1V$
- VCC Input Voltage Range: 4.3V to 5.5V
- Output Voltage Range: 0.65V to 2.7V
- Standby Current: 0 $\mu$ A (Typ)
- Operating Temperature Range: -10°C to +100°C

## Package

W(Typ) x D(Typ) x H(Max)



Typical Application Circuit, Block Diagram

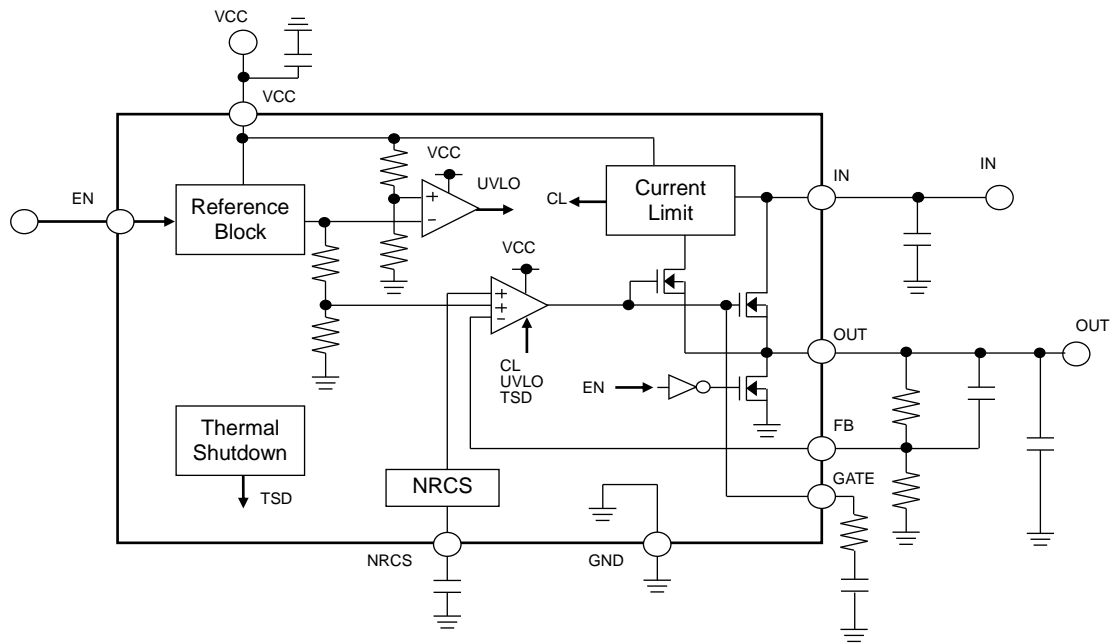

Pin Descriptions

Pin No.	Pin Name	Pin Function
1	VCC	Power supply pin
2	EN	Enable input pin
3	GATE	Gate pin
4	IN	Input voltage pin
5	OUT	Output voltage pin
6	FB	Reference voltage feedback pin
7	NRCS	In-rush current protection (NRCS) capacitor connection pin
8	GND	Ground pin
reverse	FIN	Connected to heatsink and GND

## Description of Blocks

1. AMP  
This is an error amp that compares the reference voltage (0.65V) with FB voltage to drive the output N-Channel FET. Frequency optimization aids in attaining rapid transient response, and to support the use of ceramic capacitors on the output. AMP output voltage ranges from GND to VCC. When EN is OFF, or when UVLO is active, output goes LOW and the output of the N-Channel FET switches OFF.
2. EN  
The EN block controls the ON and OFF state of the regulator via the EN logic input pin. During OFF state, circuit voltage stabilizes at 0μA which minimizes the current consumption during standby mode. The FET is switched ON to enable discharge of the NRCS and OUT, thereby draining the excess charge and preventing the load side of an IC from malfunctioning. Since there is no electrical connection required (e.g., between the VCC pin and the ESD prevention Diode), module operation is independent of the input sequence.
3. UVLO  
To prevent malfunctions that can occur during a sudden decrease in VCC, the UVLO circuit switches the output OFF, and (like the EN block) discharges NRCS and OUT. Once the UVLO threshold voltage (TYP3.80V) is reached, the power-ON reset is triggered and output is restored.
4. CURRENT LIMIT  
During ON state, the current limit function monitors the output current of the IC against the current limit value (2.0A or more: BD3552HFN). When output current exceeds this value, this block lowers the output current to protect the load IC. When it overcomes the over-current state, output voltage is restored to the normal value.
5. NRCS (Non Rush Current on Start-up)  
The soft start function is enabled by connecting an external capacitor between the NRCS pin and GND. Output ramp-up can be set for any period up to the time the NRCS pin reaches  $V_{FB}$  (0.65V). During startup, the NRCS pin serves as a 20μA (TYP) constant current source to charge the external capacitor. Output start time is calculated by formula (1) below.

$$t = C \frac{0.65V}{20\mu A} \cdot \cdot \cdot (1)$$

Tracking sequence is possible by connecting the NRCS output to an external power supply instead of external capacitor. And then, ratio-metric sequence is also available by changing the resistor divider ratio of external power supply voltage. (See page 16)

6. TSD (Thermal Shut down)  
The shutdown (TSD) circuit automatically latched OFF when the chip temperature exceeds the threshold temperature after the programmed time period elapses, thus protecting the IC against “thermal runaway” and heat damage. Since the TSD circuit is designed only to shut down the IC in the occurrence of extreme heat, it is important that the  $T_j$  (max) parameter should not be exceeded in the thermal design, in order to avoid potential problems with the TSD.
7. IN  
The IN line acts as the major current supply line, and is connected to the output N-channel FET drain. Since there is no electrical connection (such as between the VCC pin and the ESD protection Diode) required, IN operates independent of the input sequence. However, since an output N-Channel FET body diode exists between IN and OUT, a  $V_{IN}$ - $V_{OUT}$  electric (Diode) connection is present. Therefore, when output is switched ON or OFF, reverse current may flow from IN to OUT.

## Absolute Maximum Ratings (Ta=25°C)

Parameter	Symbol	Limit			Unit
		BD3550HFN	BD3551HFN	BD3552HFN	
Input Voltage 1	V <sub>CC</sub>	+6.0 (Note 1)			V
Input Voltage 2	V <sub>IN</sub>	+6.0 (Note 1)			V
Enable Input Voltage	V <sub>EN</sub>	-0.3 to +6.0			V
Power Dissipation 1	Pd1	0.63 (Note 2)			W
Power Dissipation 2	Pd2	1.35 (Note 3)			W
Power Dissipation 3	Pd3	1.75 (Note 4)			W
Operating Temperature Range	Topr	-10 to +100			°C
Storage Temperature Range	Tstg	-55 to +150			°C
Maximum Junction Temperature	Tjmax	+150			°C

(Note 1) Should not exceed Pd.

(Note 2) Derate by 5.04mW/°C for Ta above 25°C (when mounted on a 70mm x 70mm x 1.6mm glass-epoxy board, 1-layer)

On less than 0.2% (percentage occupied by copper foil).

(Note 3) Derate by 10.8mW/°C for Ta above 25°C (when mounted on a 70mm x 70mm x 1.6mm glass-epoxy board, 1-layer)

On less than 7.0% (percentage occupied by copper foil).

(Note 4) Derate by 14.0mW/°C for Ta above 25°C (when mounted on a 70mm x 70mm x 1.6mm glass-epoxy board, 1-layer)

On less than 65.0% (percentage occupied by copper foil).

**Caution:** Operating the IC over the absolute maximum ratings may damage the IC. The damage can either be a short circuit between pins or an open circuit between pins and the internal circuitry. Therefore, it is important to consider circuit protection measures, such as adding a fuse, in case the IC is operated over the absolute maximum ratings.

## Recommended Operating Conditions (Ta=25°C)

Parameter	Symbol	Min	Max	Unit
Input Voltage 1	V <sub>CC</sub>	4.3	5.5	V
Input Voltage 2	V <sub>IN</sub>	0.95	V <sub>CC</sub> -1 (Note 5)	V
Output Voltage Setting Range	V <sub>OUT</sub>	V <sub>FB</sub>	2.7	V
Enable Input Voltage	V <sub>EN</sub>	0	5.5	V
NRCS Capacity	C <sub>NRCS</sub>	0.001	1	μF

(Note 5) V<sub>CC</sub> and I<sub>N</sub> do not have to be implemented in the order listed.

## Electrical Characteristics

(Unless otherwise specified, Ta=25°C, V<sub>CC</sub>=5V, V<sub>EN</sub>=3V, V<sub>IN</sub>=1.8V, R<sub>1</sub>=3.9KΩ, R<sub>2</sub>=3.3KΩ)

Parameter	Symbol	Limit			Unit	Conditions
		Min	Typ	Max		
Bias Current	I <sub>CC</sub>	-	0.5	1.0	mA	
V <sub>CC</sub> Shutdown Mode Current	I <sub>ST</sub>	-	0	10	μA	V <sub>EN</sub> =0V
Output Voltage Temperature Coefficient	T <sub>CV0</sub>	-	0.01	-	%/°C	
Feedback Voltage 1	V <sub>FB1</sub>	0.643	0.650	0.657	V	
Feedback Voltage 2	V <sub>FB2</sub>	0.637	0.650	0.663	V	T <sub>j</sub> =-10°C to +100°C
Load Regulation	Reg.L	-	0.5	10	mV	I <sub>OUT</sub> =0A to 1A (BD3550HFN I <sub>OUT</sub> =0A to 0.5A)
Line Regulation 1	Reg.I1	-	0.1	0.5	%/V	V <sub>CC</sub> =4.3V to 5.5V
Line Regulation 2	Reg.I2	-	0.1	0.5	%/V	V <sub>IN</sub> =1.2V to 3.3V
Standby Discharge Current	I <sub>DEN</sub>	1	-	-	mA	V <sub>EN</sub> =0V, V <sub>OUT</sub> =1V
<b>[ENABLE]</b>						
Enable Pin Input Voltage High	V <sub>ENHI</sub>	2	-	-	V	
Enable Pin Input Voltage Low	V <sub>ENLOW</sub>	0	-	0.8	V	
Enable Input Bias Current	I <sub>EN</sub>	-	7	10	μA	V <sub>EN</sub> =3V
<b>[FEEDBACK]</b>						
Feedback Pin Bias Current	I <sub>FB</sub>	-100	0	+100	nA	
<b>[NRCS]</b>						
NRCS Charge Current	I <sub>NRCS</sub>	14	20	26	μA	V <sub>NRCS</sub> =0.5V
NRCS Standby Voltage	V <sub>STB</sub>	-	0	50	mV	V <sub>EN</sub> =0V

## Electrical Characteristics - continued

(Unless otherwise specified,  $T_a=25^{\circ}\text{C}$ ,  $V_{CC}=5\text{V}$ ,  $V_{EN}=3\text{V}$ ,  $V_{IN}=1.8\text{V}$ ,  $R_1=3.9\text{K}\Omega$ ,  $R_2=3.3\text{K}\Omega$ )

Parameter	Symbol	Limit			Unit	Conditions	
		Min	Typ	Max			
[UVLO]							
VCC Undervoltage Lockout Threshold Voltage	$V_{CCUVLO}$	3.5	3.8	4.1	V	VCC: Sweep-up	
VCC Undervoltage Lockout Hysteresis Voltage	$V_{CCHYS}$	100	160	220	mV	VCC: Sweep-down	
[AMP]							
Gate Source Current	$I_{GSO}$	-	1.6	-	mA	$V_{FB}=0$ , $V_{GATE}=2.5\text{V}$	
Gate Sink Current	$I_{GSI}$	-	4.7	-	mA	$V_{FB}=V_{CC}$ , $V_{GATE}=2.5\text{V}$	
Maximum Output Current	BD3550HFN	$I_{OUT}$	0.5	-	-	A	
	BD3551HFN	$I_{OUT}$	1.0	-	-	A	
	BD3552HFN	$I_{OUT}$	2.0	-	-	A	
Minimum Dropout Voltage	BD3550HFN	$dV_{OUT}$	-	200	300	mV	$I_{OUT}=0.5\text{A}$ , $V_{IN}=1.2\text{V}$ , $T_a=-10^{\circ}\text{C}$ to $+100^{\circ}\text{C}$
	BD3551HFN	$dV_{OUT}$	-	200	300	mV	$I_{OUT}=1.0\text{A}$ , $V_{IN}=1.2\text{V}$ , $T_a=-10^{\circ}\text{C}$ to $+100^{\circ}\text{C}$
	BD3552HFN	$dV_{OUT}$	-	200	300	mV	$I_{OUT}=2.0\text{A}$ , $V_{IN}=1.2\text{V}$ , $T_a=-10^{\circ}\text{C}$ to $+100^{\circ}\text{C}$

Typical Waveforms

BD3550HFN

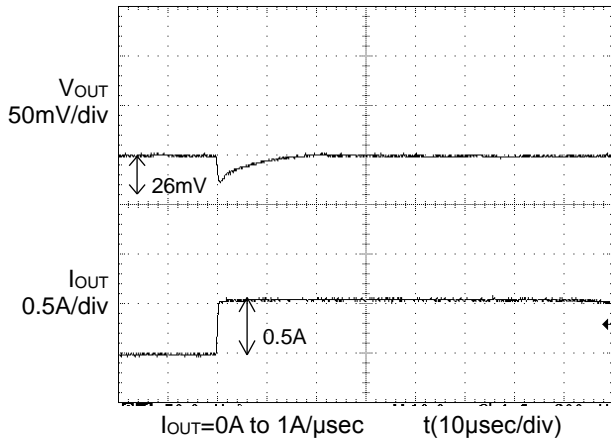

Figure 1. Transient Response  
(0A to 0.5A)  
 $C_{OUT}=100\mu\text{F}$ ,  $C_{FB}=1000\text{pF}$

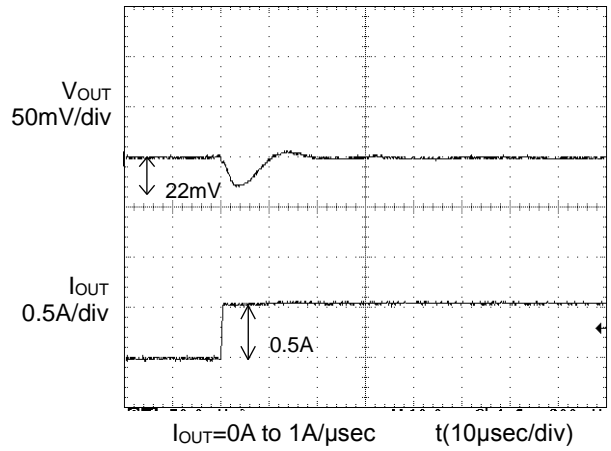

Figure 2. Transient Response  
(0A to 0.5A)  
 $C_{OUT}=47\mu\text{F}$ ,  $C_{FB}=1000\text{pF}$

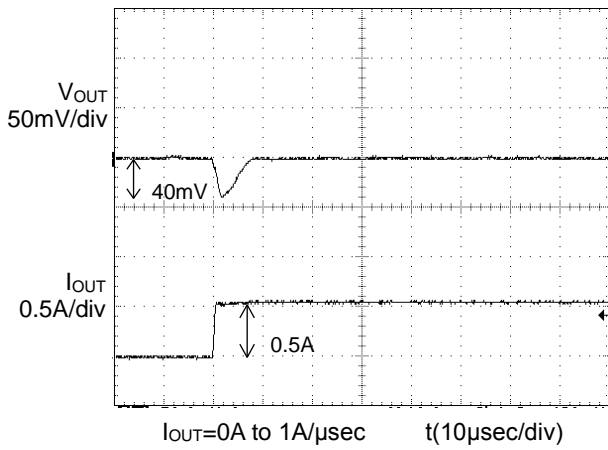

Figure 3. Transient Response  
(0A to 0.5A)  
 $C_{OUT}=22\mu\text{F}$ ,  $C_{FB}=1000\text{pF}$

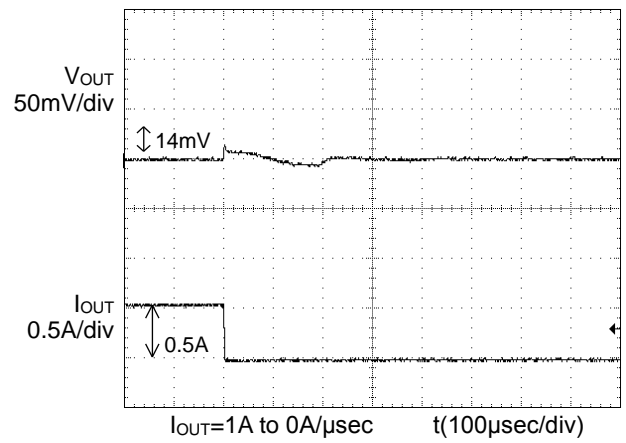

Figure 4. Transient Response  
(0.5 to 0A)  
 $C_{OUT}=100\mu\text{F}$ ,  $C_{FB}=1000\text{pF}$

Typical Waveforms – continued

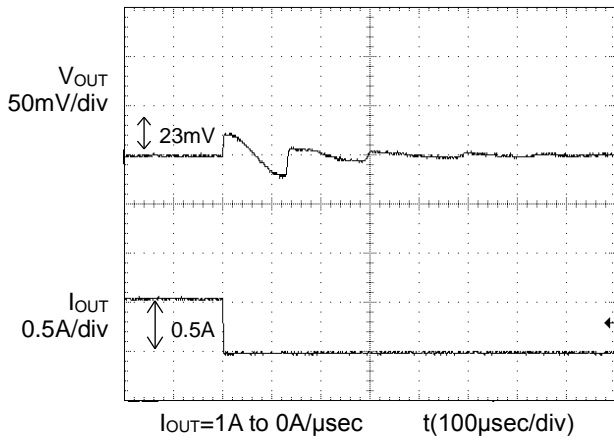

Figure 5. Transient Response  
(0.5A to 0A)  
 $C_{OUT}=47\mu\text{F}$ ,  $C_{FB}=1000\text{pF}$

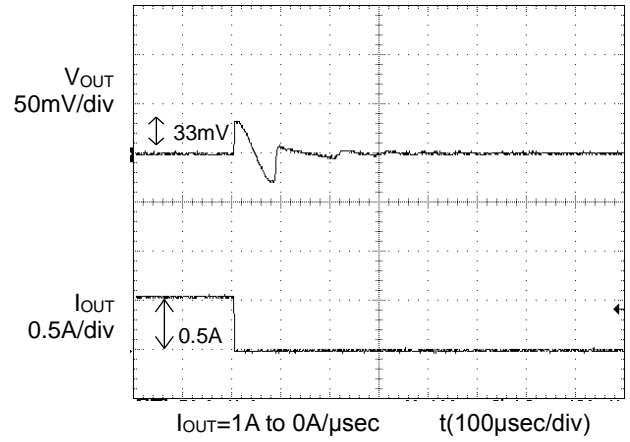

Figure 6. Transient Response  
(0.5A to 0A)  
 $C_{OUT}=22\mu\text{F}$ ,  $C_{FB}=1000\text{pF}$

BD3551HFN

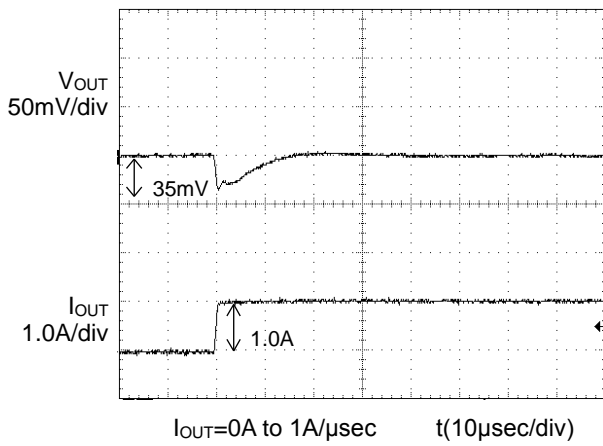

Figure 7. Transient Response  
(0A to 1.0A)  
 $C_{OUT}=100\mu\text{F}$ ,  $C_{FB}=1000\text{pF}$

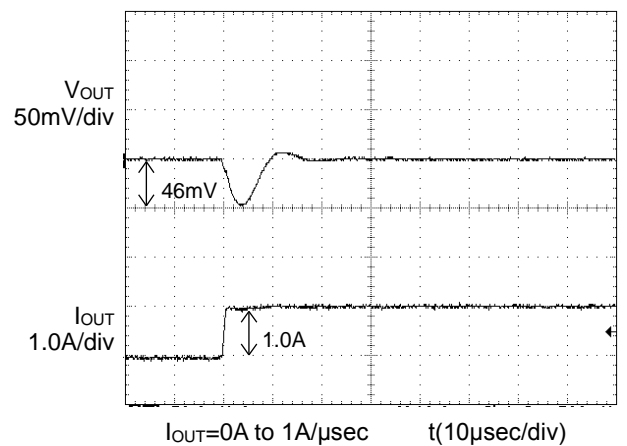

Figure 8. Transient Response  
(0A to 1.0A)  
 $C_{OUT}=47\mu\text{F}$ ,  $C_{FB}=1000\text{pF}$

Typical Waveforms – continued

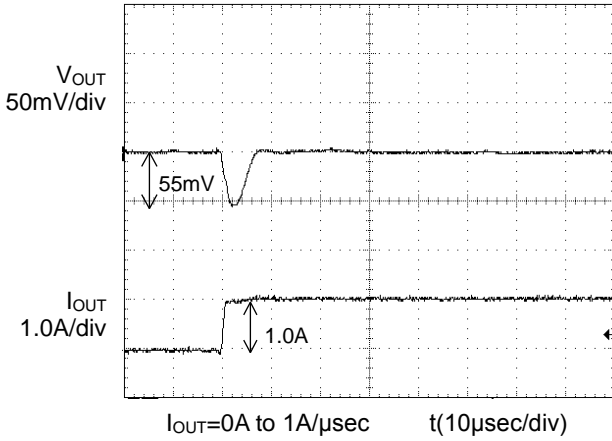

Figure 9. Transient Response  
(0A to 1.0A)  
 $C_{OUT}=22\mu F, C_{FB}=1000pF$

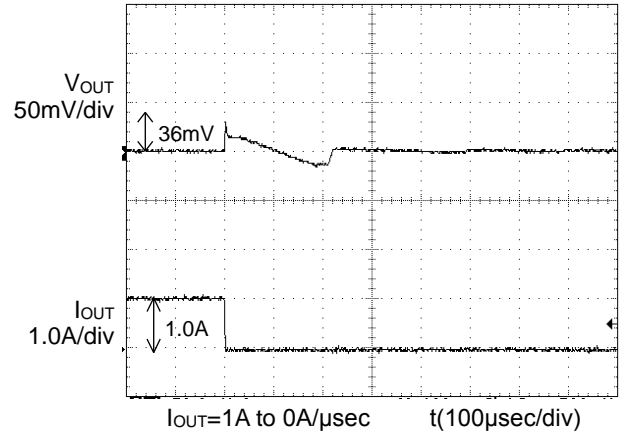

Figure 10. Transient Response  
(1.0A to 0A)  
 $C_{OUT}=100\mu F, C_{FB}=1000pF$

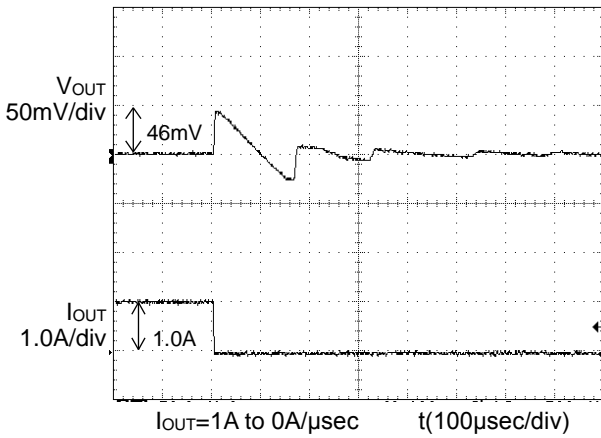

Figure 11. Transient Response  
(1.0A to 0A)  
 $C_{OUT}=47\mu F, C_{FB}=1000pF$

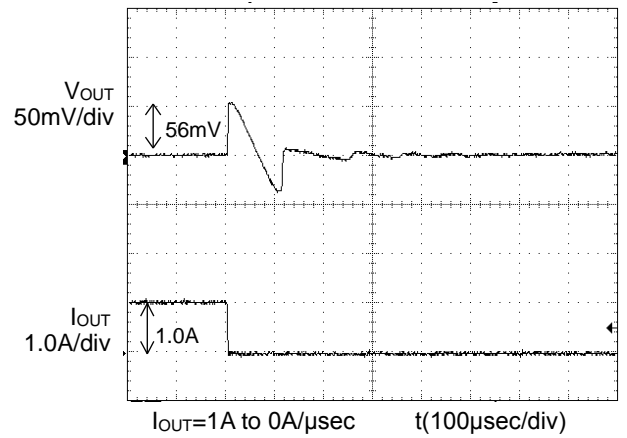

Figure 12. Transient Response  
(1.0A to 0A)  
 $C_{OUT}=22\mu F, C_{FB}=1000pF$



Typical Waveforms – continued

BD3552HFN

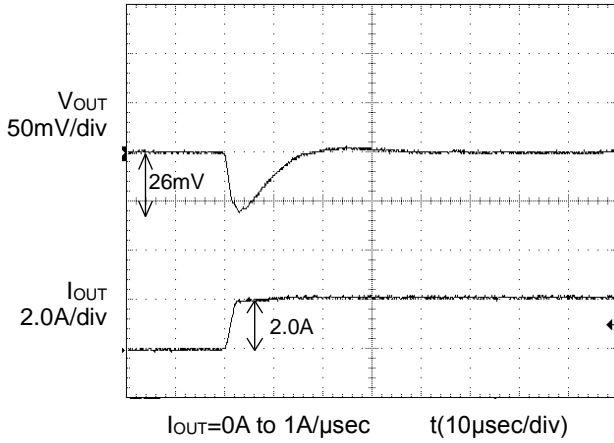

Figure 13. Transient Response  
(0A to 2.0A)  
 $C_{OUT}=100\mu F, C_{FB}=1000pF$

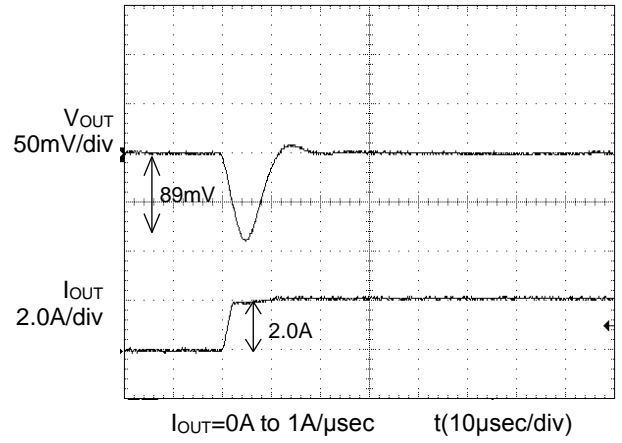

Figure 14. Transient Response  
(0A to 2.0A)  
 $C_{OUT}=47\mu F, C_{FB}=1000pF$

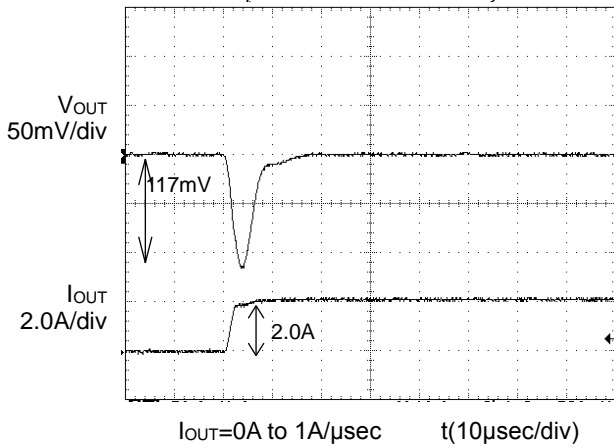

Figure 15. Transient Response  
(0A to 2.0A)  
 $C_{OUT}=22\mu F, C_{FB}=1000pF$

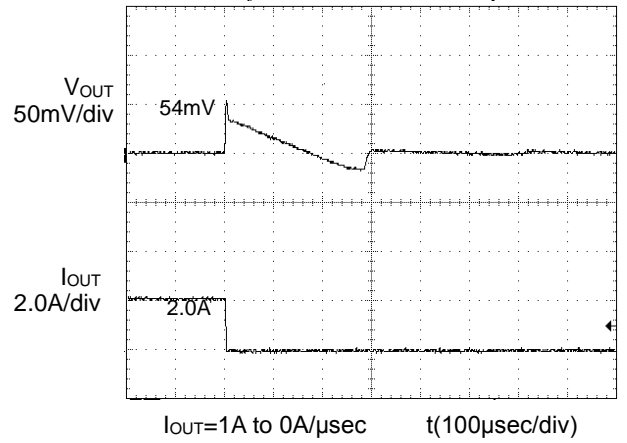

Figure 16. Transient Response  
(2.0A to 0A)  
 $C_{OUT}=100\mu F, C_{FB}=1000pF$

Typical Waveforms – continued

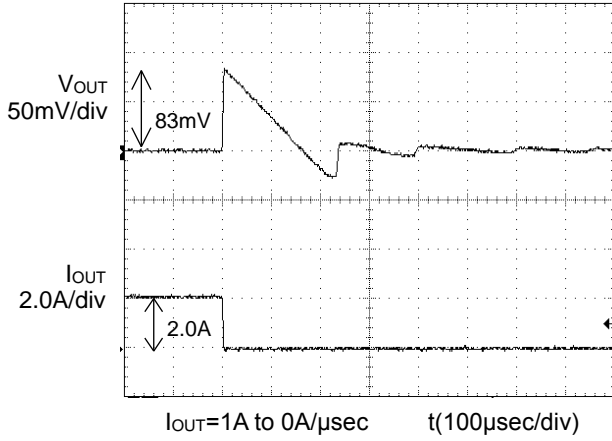

Figure 17. Transient Response  
(2.0A to 0A)  
 $C_{OUT}=47\mu F$ ,  $C_{FB}=1000pF$

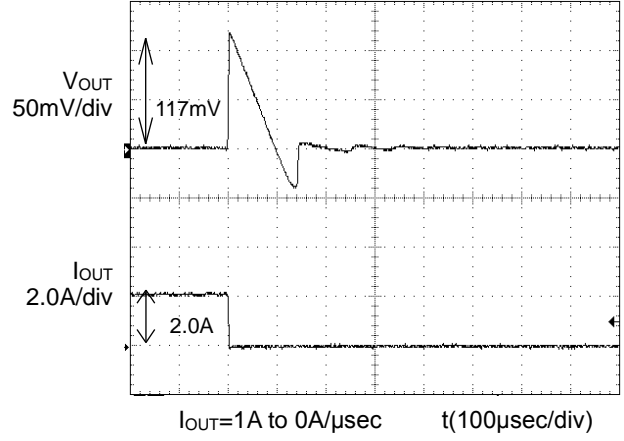

Figure 18. Transient Response  
(2.0A to 0A)  
 $C_{OUT}=22\mu F$ ,  $C_{FB}=1000pF$

BD3551HFN

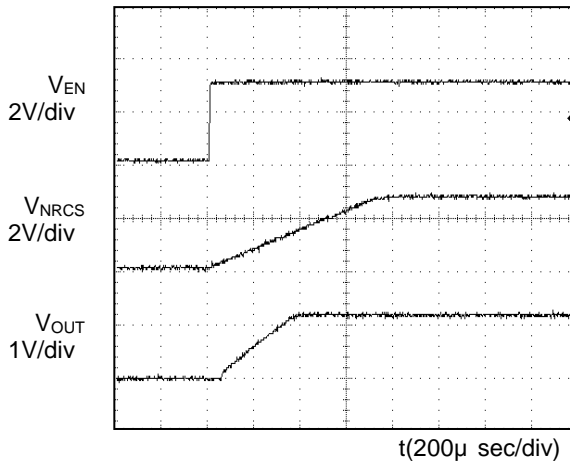

Figure 19. Waveform at Output Start

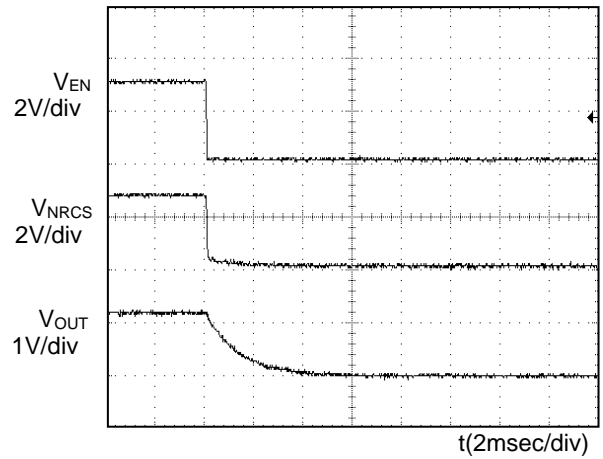

Figure 20. Waveform at Output OFF

Typical Waveforms – continued

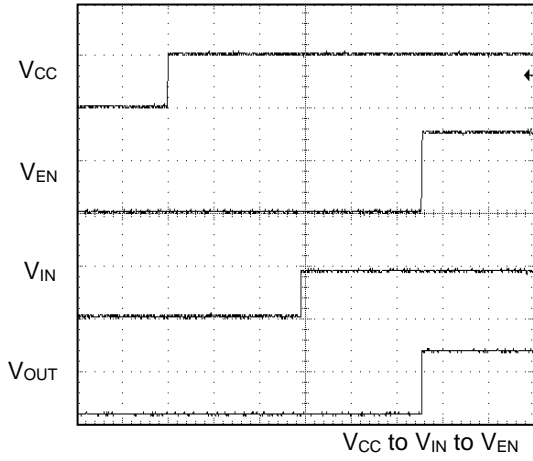

Figure 21. Input Sequence

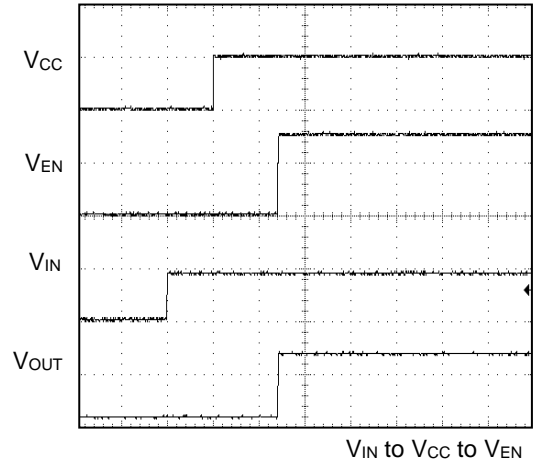

Figure 22. Input Sequence

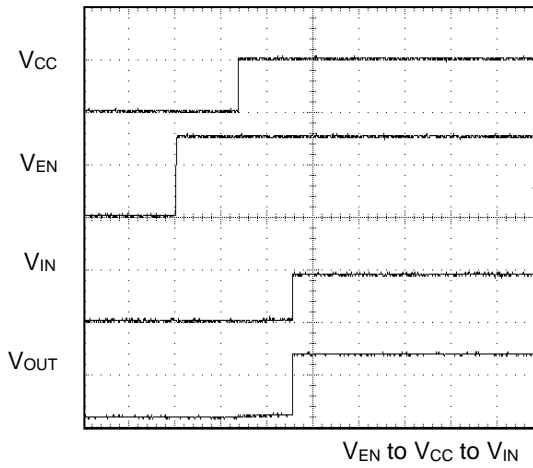

Figure 23. Input Sequence

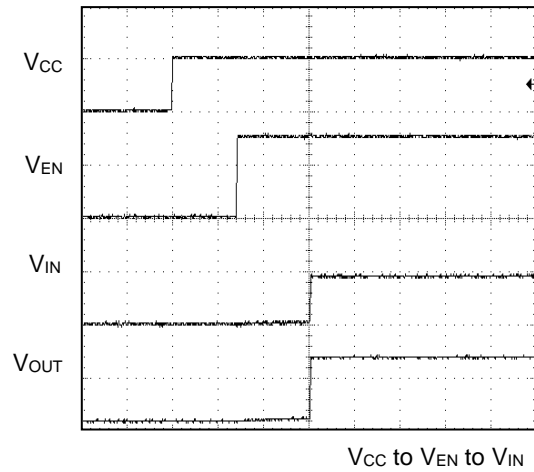

Figure 24. Input Sequence

Typical Waveforms – continued

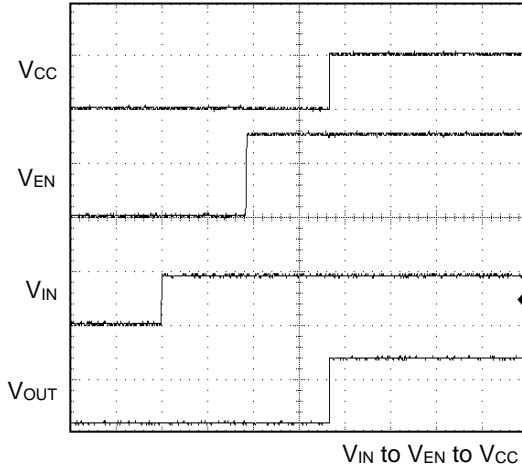

Figure 25. Input Sequence

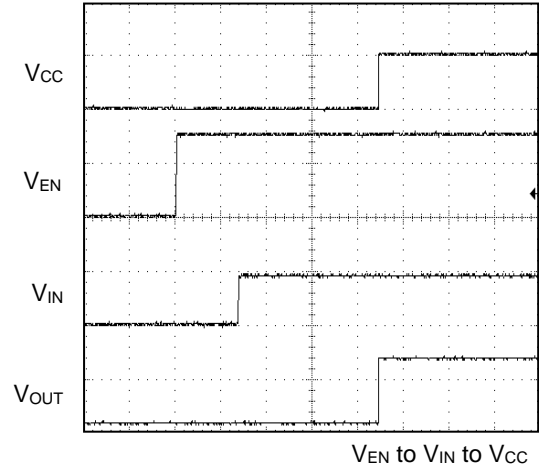

Figure 26. Input Sequence

Typical Performance Curves

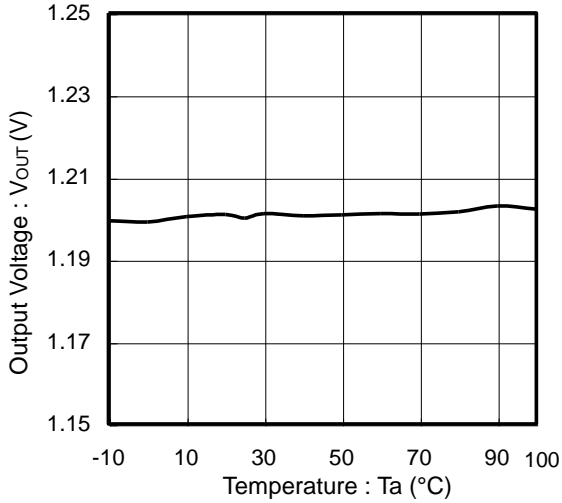

Figure 27. Output Voltage vs Temperature (I<sub>OUT</sub>=0mA)

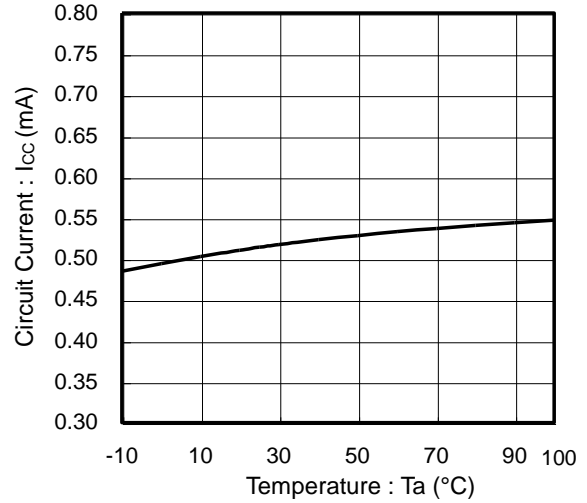

Figure 28. Circuit Current vs Temperature

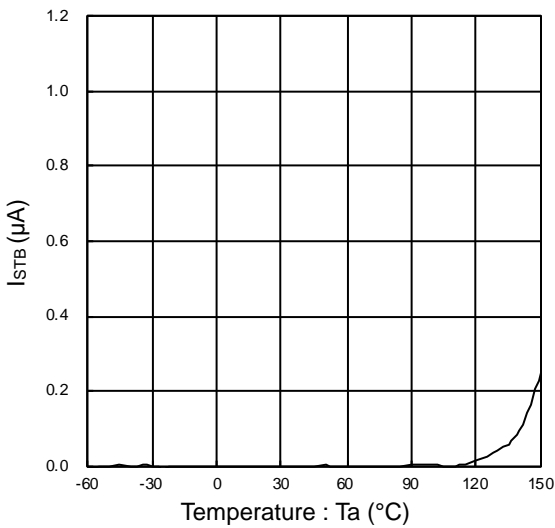

Figure 29. I<sub>STB</sub> vs Temperature

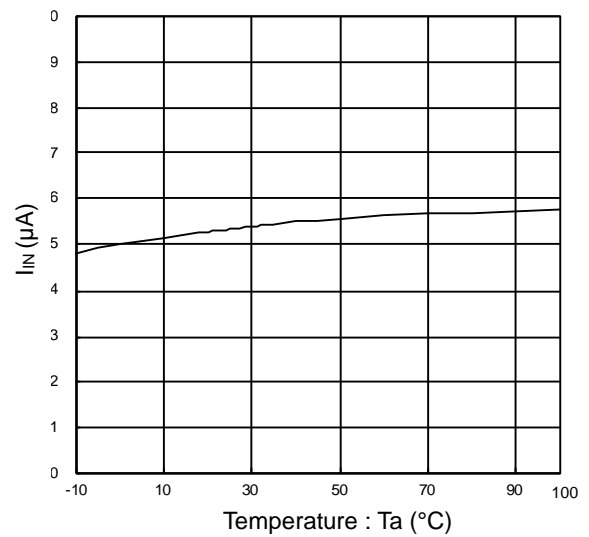

Figure 30. I<sub>IN</sub> vs Temperature

特性データ (参考データ) - 続き

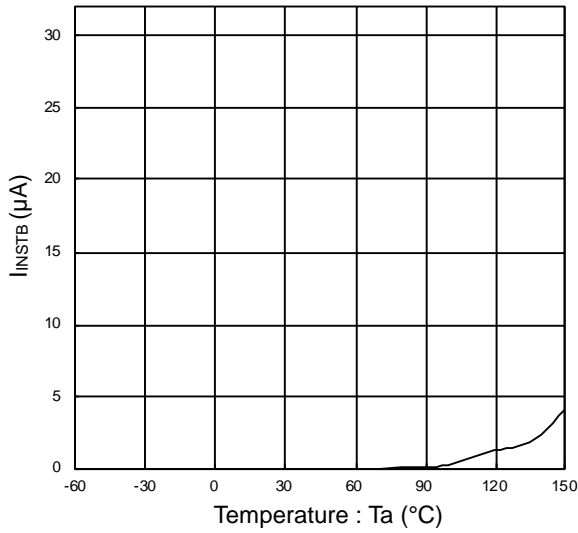

Figure 31. I<sub>INSTB</sub> vs Temperature

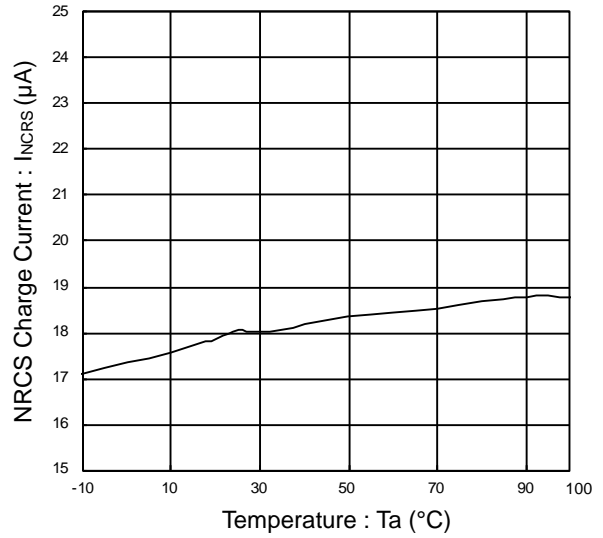

Figure 32. NCRS Charge Current vs Temperature

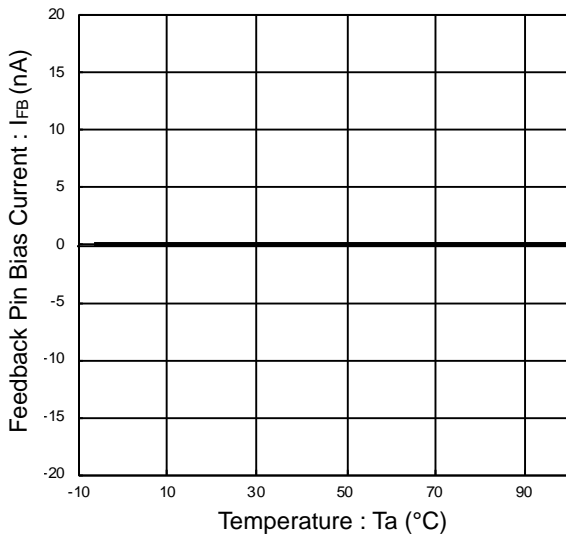

Figure 33. Feedback Pin Bias Current vs Temperature

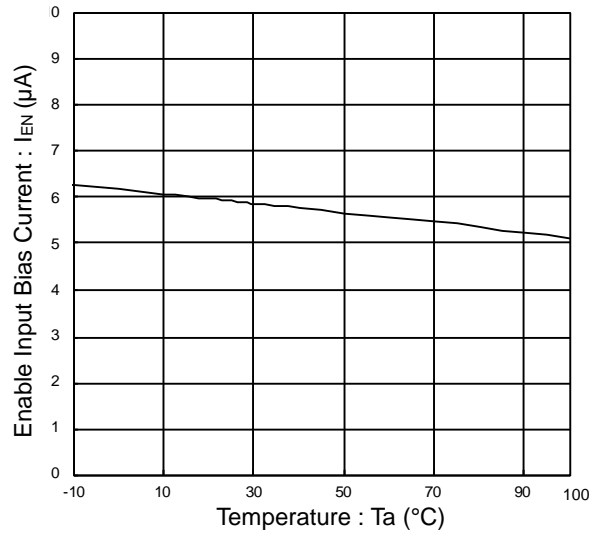

Figure 34. Enable Input Bias Current vs Temperature

特性データ (参考データ) - 続き

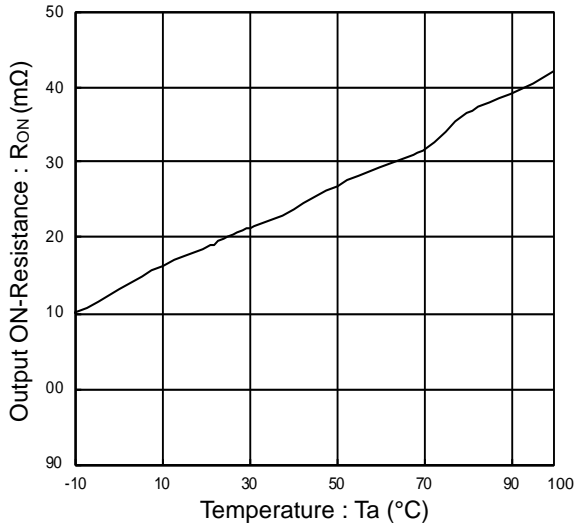

Figure 35. Output ON-Resistance vs Temperature (V<sub>CC</sub>=5V/V<sub>OUT</sub>=1.2V)

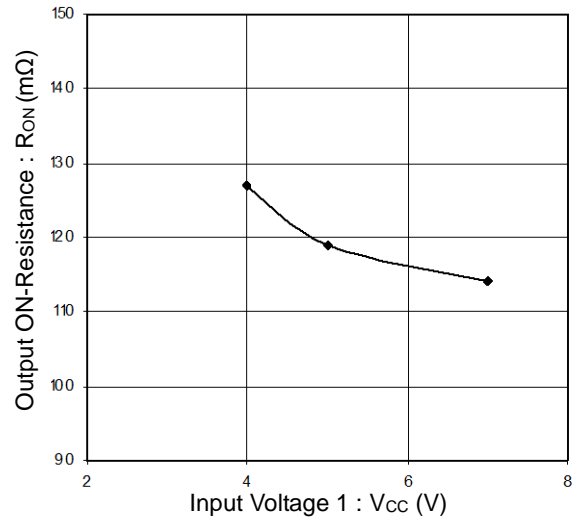
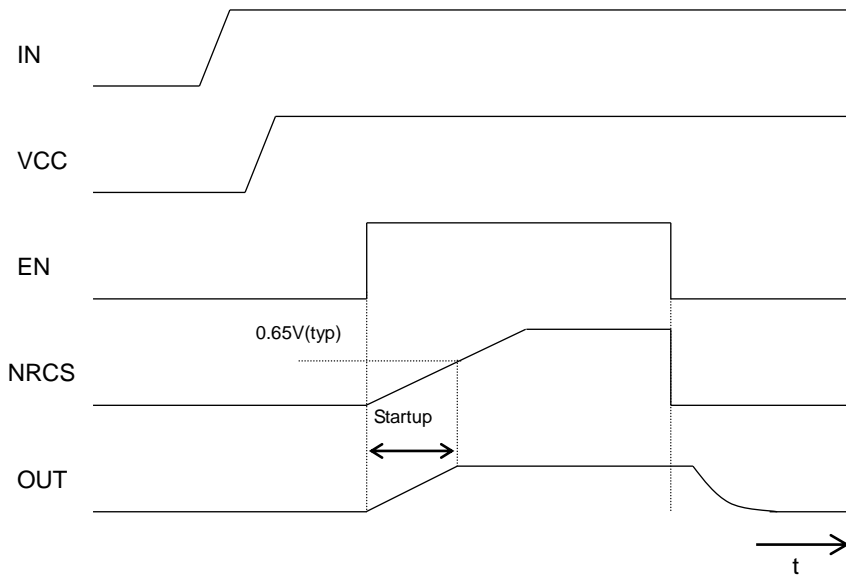

Figure 36. Output ON-Resistance vs Input Voltage 1

Timing Chart

EN ON/OFF



VCC ON/OFF

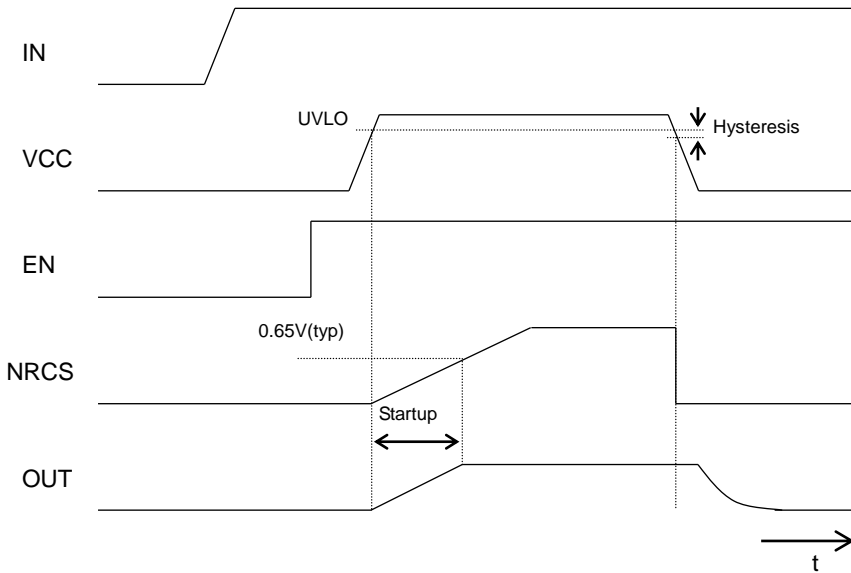

Tracking Sequence

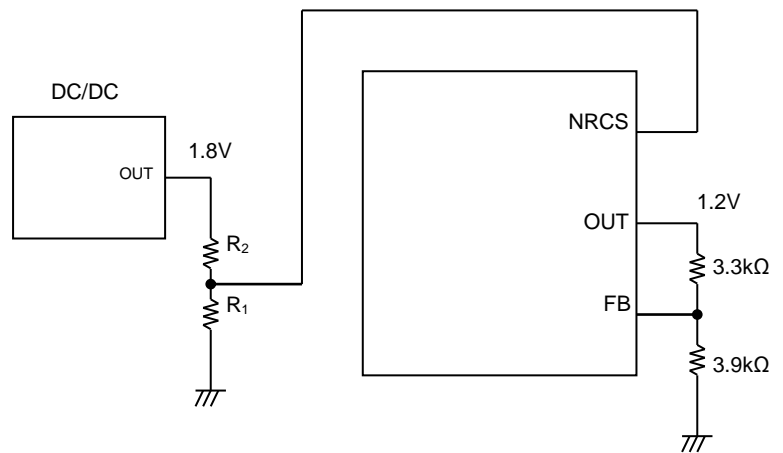
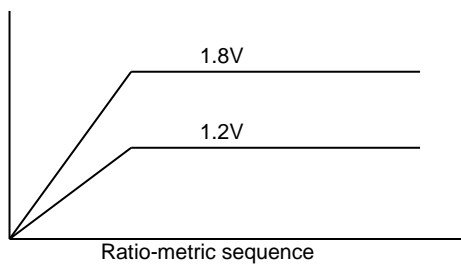
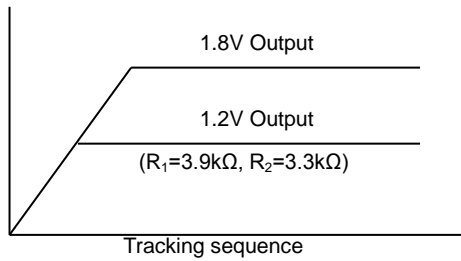



Application Information

1. Evaluation Board

BD3550HFN, BD3551HFN, BD3552HFN Evaluation Board Schematic

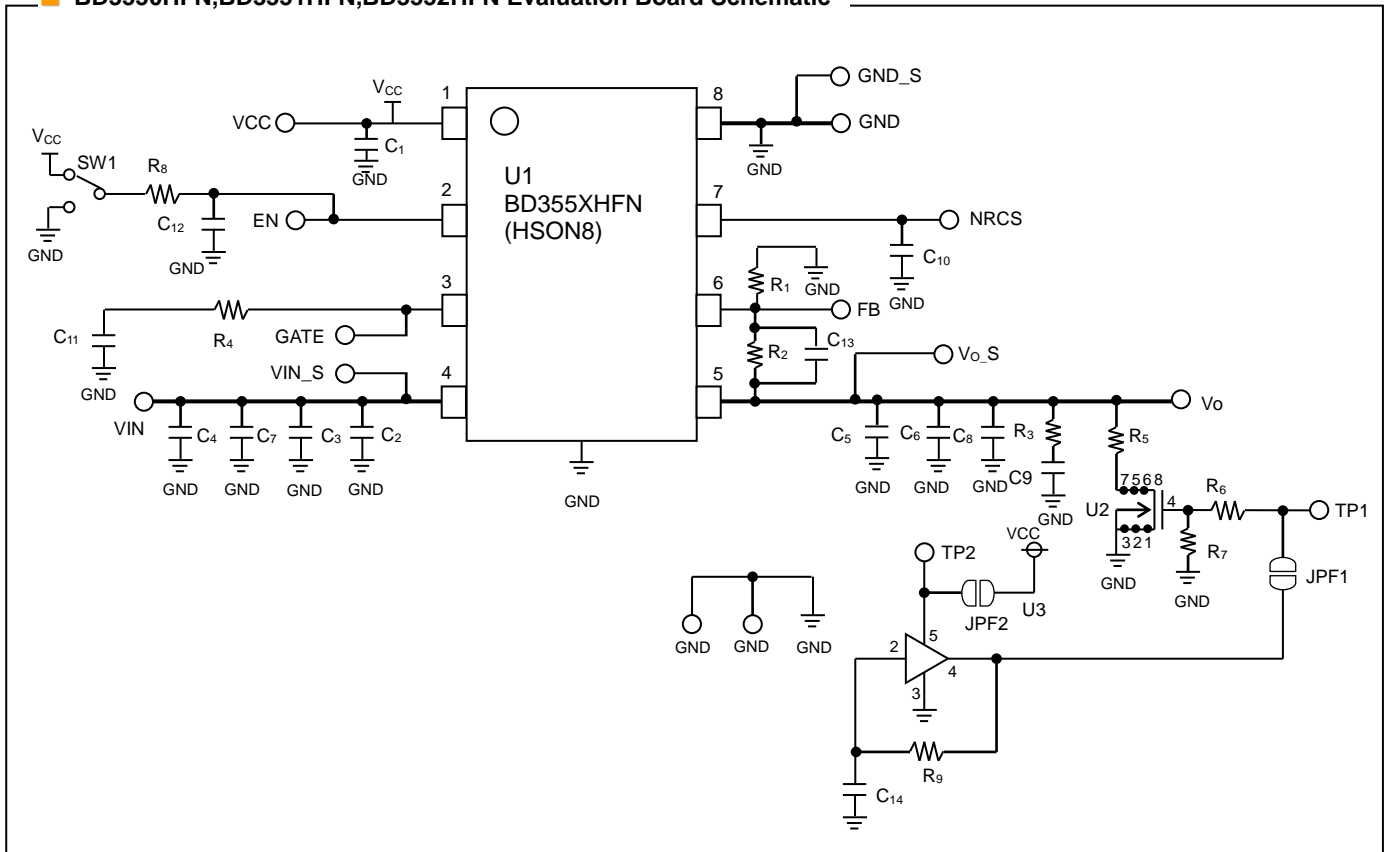

BD3550HFN, BD3551HFN, BD3552HFN Evaluation Board Standard Component List

Component	Rating	Manufacturer	Product Name
U1	-	ROHM	BD355XHFN
C1	1 $\mu$ F	MURATA	GRM188B11A105KD
C10	0.01 $\mu$ F	MURATA	GRM188B11H103KD
R8	0 $\Omega$	-	Jumper
C5	22 $\mu$ F	KYOCERA	CM32X5R226M10A

Component	Rating	Manufacturer	Product Name
C2	22 $\mu$ F	KYOCERA	CM32X5R226M10A
C13	1000pF	MURATA	GRM188B11H102KD
R1	3.9k $\Omega$	ROHM	MCR03EZPF3301
R2	3.3k $\Omega$	ROHM	MCR03EZPF3901

BD3550HFN, BD3551HFN, BD3552HFN Evaluation Board Layout  
(2nd layer and 3rd layer is GND Line.)

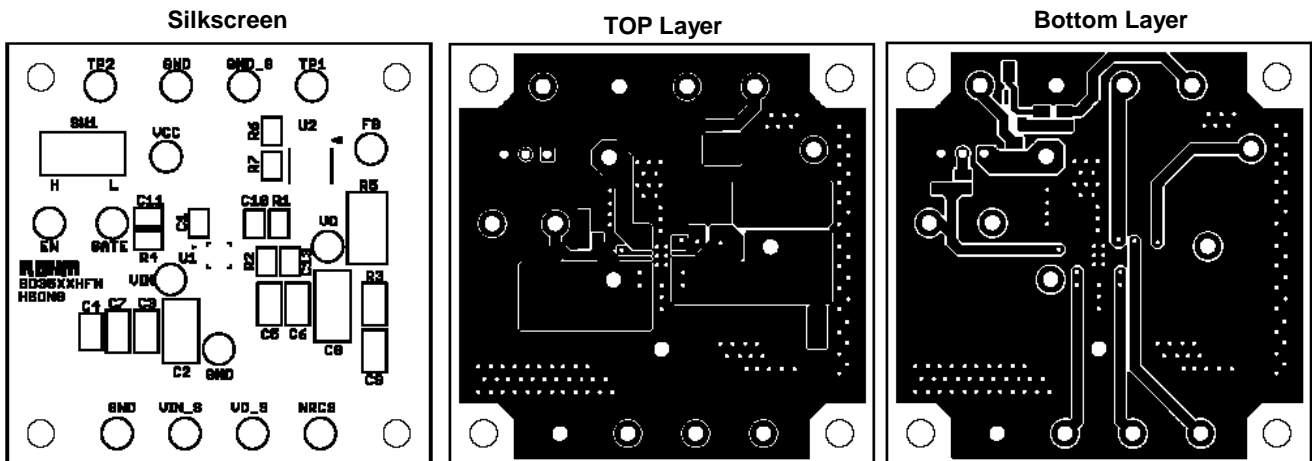

2. Recommended Circuit Example

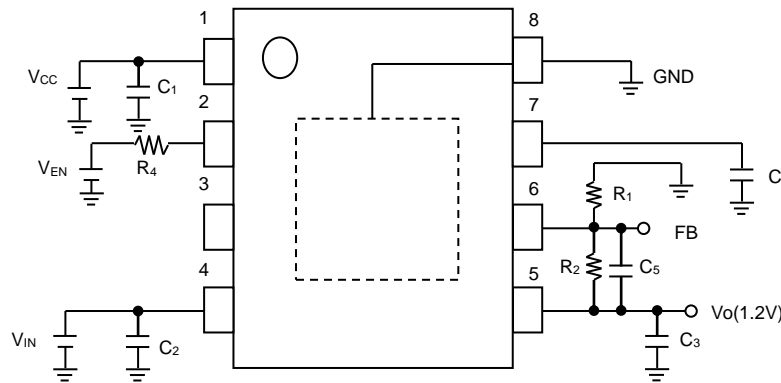

Component	Recommended Value	Programming Notes and Precautions
R <sub>1</sub> /R <sub>2</sub>	3.9kΩ/3.3kΩ	IC output voltage can be set with a configuration formula using the values for the internal reference output voltage (V <sub>FB</sub> ) and the output voltage resistors (R <sub>1</sub> , R <sub>2</sub> ). Select resistance values that will avoid the impact of the FB current (±100nA). The recommended total resistance value is 10kΩ.
C <sub>3</sub>	22μF	To assure output voltage stability, make sure the OUT pin and the GND pins are connected. Output capacitors play a role in loop gain phase compensation and in minimizing output fluctuation during rapid changes in load level. Insufficient capacitance may cause oscillation, while high equivalent series resistance (ESR) will exacerbate output voltage fluctuation under rapid load change conditions. While a 22μF ceramic capacitor is recommended, actual stability is highly dependent on temperature and load conditions. Also, note that connecting different types of capacitors in series may result in insufficient total phase compensation, thus causing oscillation. In light of this information, please confirm operation across a variety of temperature and load conditions.
C <sub>1</sub> / C <sub>2</sub>	1μF/22μF	Input capacitors reduce the output impedance of the voltage supply source connected to the (V <sub>CC</sub> , I <sub>N</sub> ) input pins. If the impedance of this power supply were to increase, input voltage (V <sub>CC</sub> , V <sub>IN</sub> ) could become unstable, leading to oscillation or decreased ripple rejection ability. While a low-ESR 1μF/22μF capacitor with minimal susceptibility to temperature is recommended, stability is highly dependent on the input power supply characteristics and the substrate wiring pattern. In light of this information, please confirm operation across a variety of temperature and load conditions.
C <sub>4</sub>	0.01μF	The Non Rush Current on Startup (NRCS) function is built into the IC to prevent rush current from going through the load (I <sub>N</sub> to OUT) and affecting output capacitors at power supply start-up. Constant current comes from the NRCS pin when EN is HIGH or the UVLO function is deactivated. The temporary reference voltage is proportional to time, due to the current charge of the NRCS pin capacitor, and output voltage start-up is proportional to this reference voltage. Capacitors with low susceptibility to temperature are recommended, in order to ensure a stable soft-start time.
C <sub>5</sub>	-	This component is employed when the C <sub>3</sub> capacitor causes, or may cause, oscillation. It provides more precise internal phase correction.
R <sub>4</sub>	Several kΩ to several 10kΩ	It is recommended that a resistance (several kΩ to several 10kΩ) be put in R <sub>4</sub> , in case negative voltage is applied in EN pin.

### 3. Heat Loss

In thermal design consider the temperature range wherein the IC is guaranteed to operate and apply appropriate margins. The temperature conditions that need to be considered are listed below:

- (1) Ambient temperature  $T_a$  can be no higher than 100°C.
- (2) Chip junction temperature ( $T_j$ ) can be no higher than 150°C.

Chip junction temperature can be determined as follows:

- ① Calculation based on ambient temperature ( $T_a$ )

$$T_j = T_a + \theta_j - a \times W$$

<Reference values>

$\theta_j$ -a: HSON8	198.4°C/W	1-layer substrate (copper foil density 0.2%)
	92.4°C/W	1-layer substrate (copper foil density 7%)
	71.4°C/W	2-layer substrate (copper foil density 65%)
		Substrate size: 70mm x 70mm x 1.6mm <sup>3</sup> (substrate with thermal via)

It is recommended to layout the VIA for heat radiation in the GND pattern of reverse (of IC) when there is the GND pattern in the inner layer (in using multilayer substrate). This package is so small (size: 2.9mm x 3.0mm) that it is not available to layout the VIA in the bottom of IC. Spreading the pattern and being increased the number of VIA as shown in the figure below), enable to achieve superior heat radiation characteristic. (This figure is an image only. It is recommended that the VIA size and the number is designed suitable for the actual situation.)

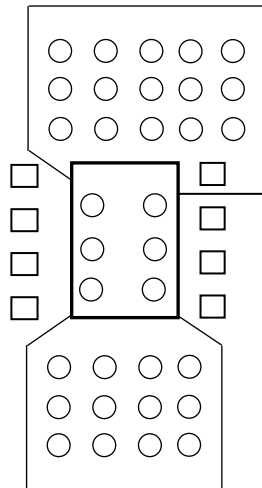

Most of the heat loss in BD3550HFN, BD3551HFN, BD3552HFN occurs at the output N-Channel FET. Power loss is determined by the total IN-OUT voltage and output current. Be sure to confirm the system input and output voltage and the output current conditions in relation to the heat dissipation characteristics of the IN and OUT in the design. Bearing in mind that heat dissipation may vary substantially depending on the substrate employed make sure to factor conditions such as substrate size into the thermal design.

$$\text{Power consumption (W)} = \left\{ \text{Input voltage (V}_{IN}) - \text{Output voltage (V}_{OUT}) \right\} \times I_{OUT(Ave)}$$

Example) Where  $V_{IN}=1.8V$ ,  $V_{OUT}=1.2V$ ,  $I_{OUT(Ave)} = 1A$ ,

$$\begin{aligned} \text{Power consumption (W)} &= \{1.8(V) - 1.2(V)\} \times 1.0(A) \\ &= 0.6(W) \end{aligned}$$

©HSON8

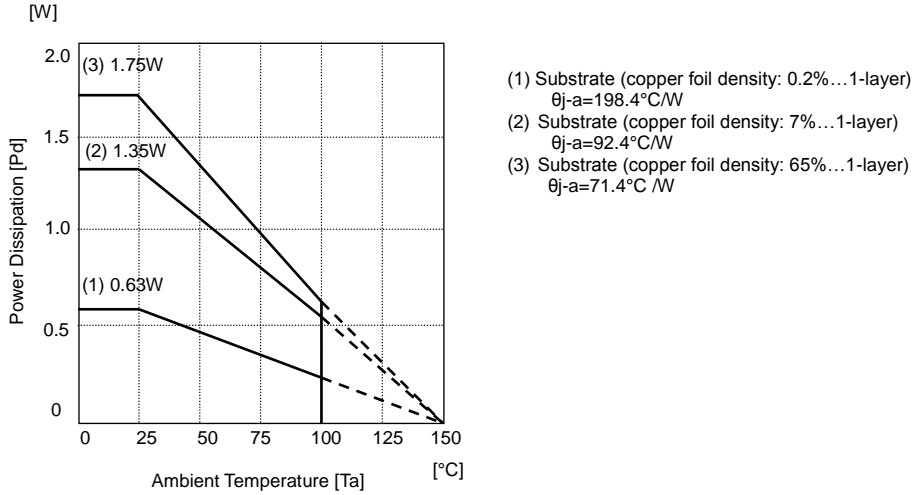

4. Reference Landing Pattern

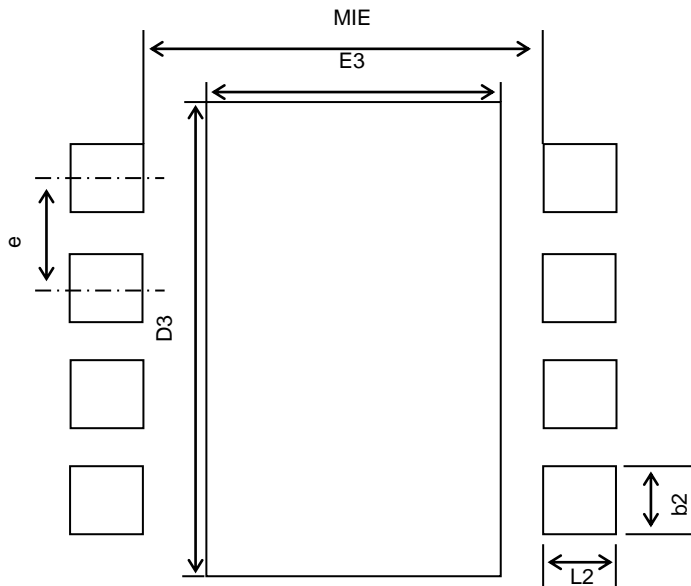

(Unit: mm)

Lead pitch	Lead pitch	landing length	landing pitch
e	MIE	$\geq 2$	b2
0.65	2.50	0.40	0.35
central pad length	central pad pitch		
D3	E3		
2.90	1.90		

(Note) It is recommended to design suitable for the actual application.

I/O Equivalent Circuits

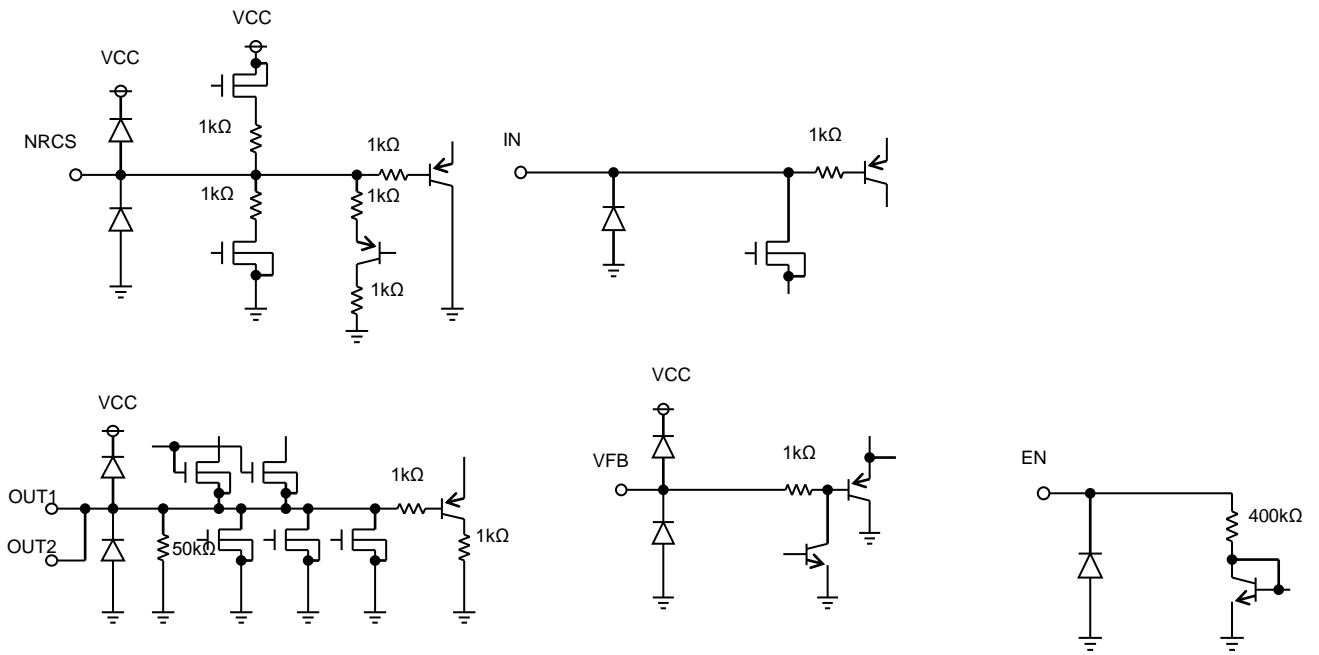

## Operational Notes

### 1. Reverse Connection of Power Supply

Connecting the power supply in reverse polarity can damage the IC. Take precautions against reverse polarity when connecting the power supply, such as mounting an external diode between the power supply and the IC's power supply terminals.

### 2. Power Supply Lines

Design the PCB layout pattern to provide low impedance supply lines. Separate the ground and supply lines of the digital and analog blocks to prevent noise in the ground and supply lines of the digital block from affecting the analog block. Furthermore, connect a capacitor to ground at all power supply pins. Consider the effect of temperature and aging on the capacitance value when using electrolytic capacitors.

### 3. Ground Voltage

Ensure that no pins are at a voltage below that of the ground pin at any time, even during transient condition.

### 4. Ground Wiring Pattern

When using both small-signal and large-current ground traces, the two ground traces should be routed separately but connected to a single ground at the reference point of the application board to avoid fluctuations in the small-signal ground caused by large currents. Also ensure that the ground traces of external components do not cause variations on the ground voltage. The ground lines must be as short and thick as possible to reduce line impedance.

### 5. Thermal Consideration

Should by any chance the power dissipation rating be exceeded, the rise in temperature of the chip may result in deterioration of the properties of the chip. The absolute maximum rating of the Pd stated in this specification is when the IC is mounted on a 70mm x 70mm x 1.6mm glass epoxy board. In case of exceeding this absolute maximum rating, increase the board size and copper area to prevent exceeding the Pd rating.

### 6. Recommended Operating Conditions

These conditions represent a range within which the expected characteristics of the IC can be approximately obtained. The electrical characteristics are guaranteed under the conditions of each parameter.

### 7. Inrush Current

When power is first supplied to the IC, it is possible that the internal logic may be unstable and inrush current may flow instantaneously due to the internal powering sequence and delays, especially if the IC has more than one power supply. Therefore, give special consideration to power coupling capacitance, power wiring, width of ground wiring, and routing of connections.

### 8. Operation Under Strong Electromagnetic Field

Operating the IC in the presence of a strong electromagnetic field may cause the IC to malfunction.

### 9. Testing on Application Boards

When testing the IC on an application board, connecting a capacitor directly to a low-impedance output pin may subject the IC to stress. Always discharge capacitors completely after each process or step. The IC's power supply should always be turned OFF completely before connecting or removing it from the test setup during the inspection process. To prevent damage from static discharge, ground the IC during assembly and use similar precautions during transport and storage.

### 10. Inter-pin Short and Mounting Errors

Ensure that the direction and position are correct when mounting the IC on the PCB. Incorrect mounting may result in damaging the IC. Avoid nearby pins being shorted to each other especially to ground, power supply and output pin. Inter-pin shorts could be due to many reasons such as metal particles, water droplets (in very humid environment) and unintentional solder bridge deposited in between pins during assembly to name a few.

### 11. Unused Input Terminals

Input terminals of an IC are often connected to the gate of a MOS transistor. The gate has extremely high impedance and extremely low capacitance. If left unconnected, the electric field from the outside can easily charge it. The small charge acquired in this way is enough to produce a significant effect on the conduction through the transistor and cause unexpected operation of the IC. So unless otherwise specified, unused input terminals should be connected to the power supply or ground line.

Operational Notes - continued

12. Regarding Input Pins of the IC

This monolithic IC contains P+ isolation and P substrate layers between adjacent elements in order to keep them isolated. P-N junctions are formed at the intersection of the P layers with the N layers of other elements, creating a parasitic diode or transistor. For example (refer to figure below):

When  $GND > Pin A$  and  $GND > Pin B$ , the P-N junction operates as a parasitic diode.  
 When  $GND > Pin B$ , the P-N junction operates as a parasitic transistor.

Parasitic diodes inevitably occur in the structure of the IC. The operation of parasitic diodes can result in mutual interference among circuits, operational faults, or physical damage. Therefore, conditions that cause these diodes to operate, such as applying a voltage lower than the GND voltage to an input pin (and thus to the P substrate) should be avoided.

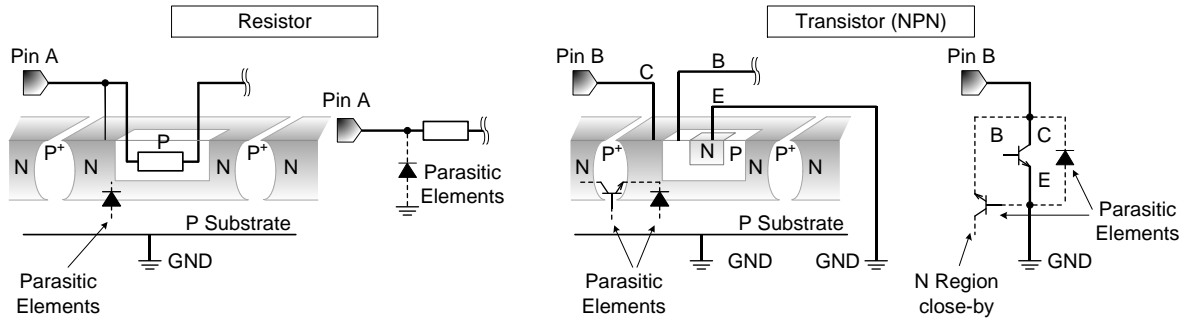

Figure 37. Example of Monolithic IC Structure

13. Area of Safe Operation (ASO)

Operate the IC such that the output voltage, output current, and power dissipation are all within the Area of Safe Operation (ASO).

14. Thermal Shutdown Circuit (TSD)

This IC has a built-in thermal shutdown circuit that prevents heat damage to the IC. Normal operation should always be within the IC's power dissipation rating. If however the rating is exceeded for a continued period, the junction temperature ( $T_j$ ) will rise which will activate the TSD circuit that will turn OFF all output pins. When the  $T_j$  falls below the TSD threshold, the circuits are automatically restored to normal operation.

Note that the TSD circuit operates in a situation that exceeds the absolute maximum ratings and therefore, under no circumstances, should the TSD circuit be used in a set design or for any purpose other than protecting the IC from heat damage.

	TSD on temperature [°C] (typ)	Hysteresis temperature [°C] (typ)
BD3550HFN, BD3551HFN, BD3552HFN	175	15

15. Output Protection Diode

Please add a protection diode when a large inductance component is connected to the output terminal, and reverse-polarity power is possible at startup or in output OFF condition.

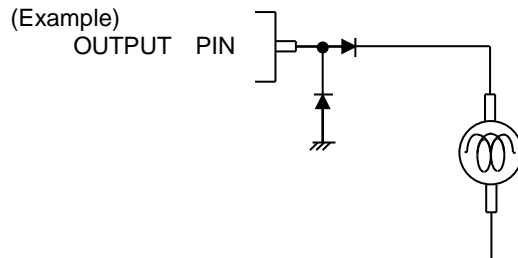

Ordering Information

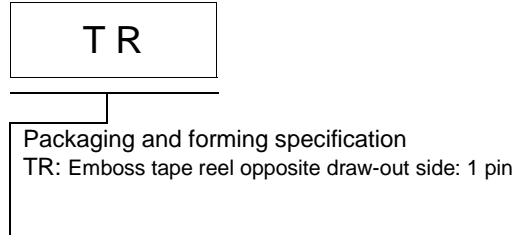
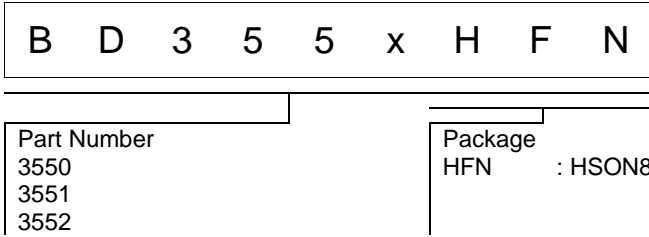

Marking Diagrams

● BD3550HFN

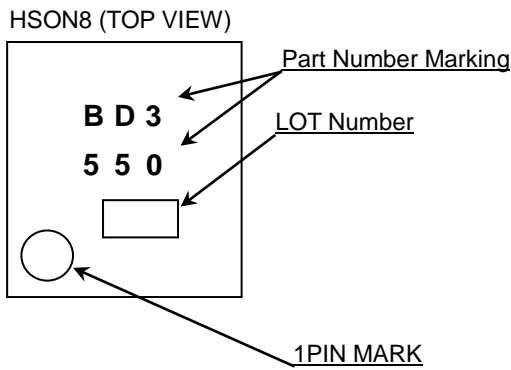

● BD3551HFN

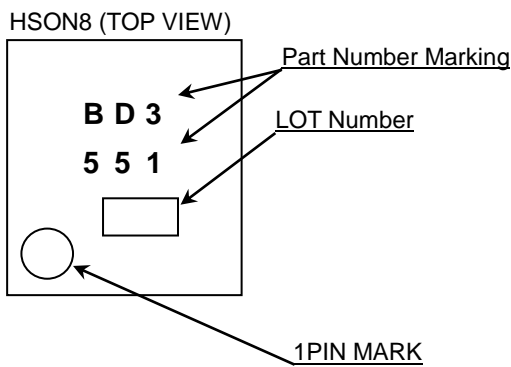

● BD3552HFN

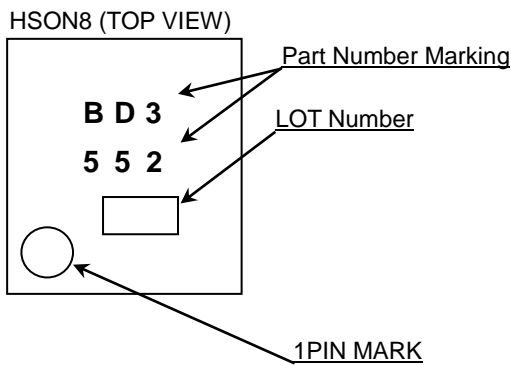



Physical Dimension, Tape and Reel Information

Package Name	HSO8
--------------	------

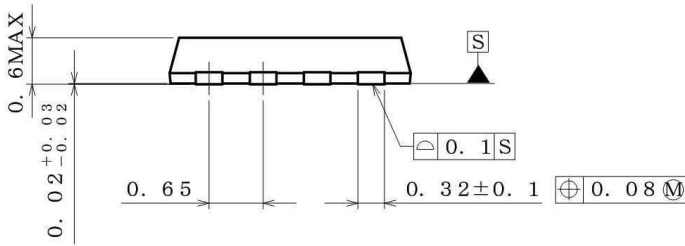
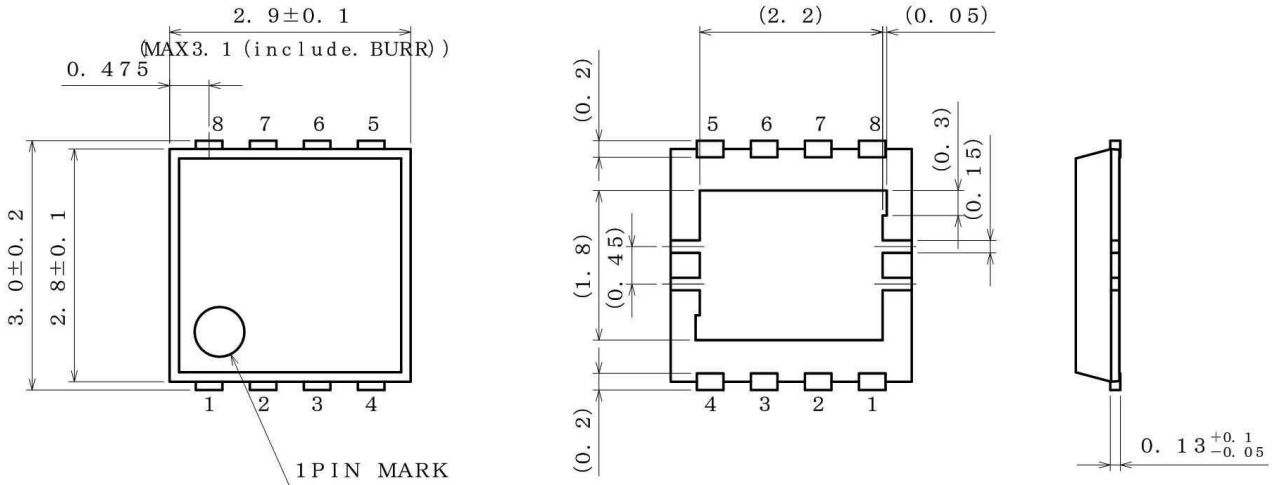

(UNIT : mm)  
 PKG : HSO8  
 Drawing No. EX163-5002

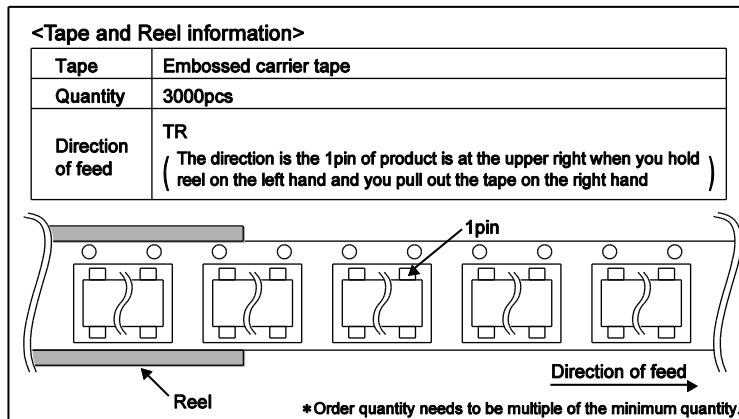

Revision History

Date	Revision	Changes
02.Nov.2015	001	New Release

# Notice

## Precaution on using ROHM Products

- Our Products are designed and manufactured for application in ordinary electronic equipments (such as AV equipment, OA equipment, telecommunication equipment, home electronic appliances, amusement equipment, etc.). If you intend to use our Products in devices requiring extremely high reliability (such as medical equipment <sup>(Note 1)</sup>, transport equipment, traffic equipment, aircraft/spacecraft, nuclear power controllers, fuel controllers, car equipment including car accessories, safety devices, etc.) and whose malfunction or failure may cause loss of human life, bodily injury or serious damage to property ("Specific Applications"), please consult with the ROHM sales representative in advance. Unless otherwise agreed in writing by ROHM in advance, ROHM shall not be in any way responsible or liable for any damages, expenses or losses incurred by you or third parties arising from the use of any ROHM's Products for Specific Applications.

(Note1) Medical Equipment Classification of the Specific Applications

JAPAN	USA	EU	CHINA
CLASS III	CLASS III	CLASS II b	CLASS III
CLASS IV		CLASS III	

- ROHM designs and manufactures its Products subject to strict quality control system. However, semiconductor products can fail or malfunction at a certain rate. Please be sure to implement, at your own responsibilities, adequate safety measures including but not limited to fail-safe design against the physical injury, damage to any property, which a failure or malfunction of our Products may cause. The following are examples of safety measures:
  - Installation of protection circuits or other protective devices to improve system safety
  - Installation of redundant circuits to reduce the impact of single or multiple circuit failure
- Our Products are designed and manufactured for use under standard conditions and not under any special or extraordinary environments or conditions, as exemplified below. Accordingly, ROHM shall not be in any way responsible or liable for any damages, expenses or losses arising from the use of any ROHM's Products under any special or extraordinary environments or conditions. If you intend to use our Products under any special or extraordinary environments or conditions (as exemplified below), your independent verification and confirmation of product performance, reliability, etc. prior to use, must be necessary:
  - Use of our Products in any types of liquid, including water, oils, chemicals, and organic solvents
  - Use of our Products outdoors or in places where the Products are exposed to direct sunlight or dust
  - Use of our Products in places where the Products are exposed to sea wind or corrosive gases, including Cl<sub>2</sub>, H<sub>2</sub>S, NH<sub>3</sub>, SO<sub>2</sub>, and NO<sub>2</sub>
  - Use of our Products in places where the Products are exposed to static electricity or electromagnetic waves
  - Use of our Products in proximity to heat-producing components, plastic cords, or other flammable items
  - Sealing or coating our Products with resin or other coating materials
  - Use of our Products without cleaning residue of flux (even if you use no-clean type fluxes, cleaning residue of flux is recommended); or Washing our Products by using water or water-soluble cleaning agents for cleaning residue after soldering
  - Use of the Products in places subject to dew condensation
- The Products are not subject to radiation-proof design.
- Please verify and confirm characteristics of the final or mounted products in using the Products.
- In particular, if a transient load (a large amount of load applied in a short period of time, such as pulse. is applied, confirmation of performance characteristics after on-board mounting is strongly recommended. Avoid applying power exceeding normal rated power; exceeding the power rating under steady-state loading condition may negatively affect product performance and reliability.
- De-rate Power Dissipation depending on ambient temperature. When used in sealed area, confirm that it is the use in the range that does not exceed the maximum junction temperature.
- Confirm that operation temperature is within the specified range described in the product specification.
- ROHM shall not be in any way responsible or liable for failure induced under deviant condition from what is defined in this document.

## Precaution for Mounting / Circuit board design

- When a highly active halogenous (chlorine, bromine, etc.) flux is used, the residue of flux may negatively affect product performance and reliability.
- In principle, the reflow soldering method must be used on a surface-mount products, the flow soldering method must be used on a through hole mount products. If the flow soldering method is preferred on a surface-mount products, please consult with the ROHM representative in advance.

For details, please refer to ROHM Mounting specification

**Precautions Regarding Application Examples and External Circuits**

1. If change is made to the constant of an external circuit, please allow a sufficient margin considering variations of the characteristics of the Products and external components, including transient characteristics, as well as static characteristics.
2. You agree that application notes, reference designs, and associated data and information contained in this document are presented only as guidance for Products use. Therefore, in case you use such information, you are solely responsible for it and you must exercise your own independent verification and judgment in the use of such information contained in this document. ROHM shall not be in any way responsible or liable for any damages, expenses or losses incurred by you or third parties arising from the use of such information.

**Precaution for Electrostatic**

This Product is electrostatic sensitive product, which may be damaged due to electrostatic discharge. Please take proper caution in your manufacturing process and storage so that voltage exceeding the Products maximum rating will not be applied to Products. Please take special care under dry condition (e.g. Grounding of human body / equipment / solder iron, isolation from charged objects, setting of Ionizer, friction prevention and temperature / humidity control).

**Precaution for Storage / Transportation**

1. Product performance and soldered connections may deteriorate if the Products are stored in the places where:
  - [a] the Products are exposed to sea winds or corrosive gases, including Cl<sub>2</sub>, H<sub>2</sub>S, NH<sub>3</sub>, SO<sub>2</sub>, and NO<sub>2</sub>
  - [b] the temperature or humidity exceeds those recommended by ROHM
  - [c] the Products are exposed to direct sunshine or condensation
  - [d] the Products are exposed to high Electrostatic
2. Even under ROHM recommended storage condition, solderability of products out of recommended storage time period may be degraded. It is strongly recommended to confirm solderability before using Products of which storage time is exceeding the recommended storage time period.
3. Store / transport cartons in the correct direction, which is indicated on a carton with a symbol. Otherwise bent leads may occur due to excessive stress applied when dropping of a carton.
4. Use Products within the specified time after opening a humidity barrier bag. Baking is required before using Products of which storage time is exceeding the recommended storage time period.

**Precaution for Product Label**

QR code printed on ROHM Products label is for ROHM's internal use only.

**Precaution for Disposition**

When disposing Products please dispose them properly using an authorized industry waste company.

**Precaution for Foreign Exchange and Foreign Trade act**

Since concerned goods might be fallen under listed items of export control prescribed by Foreign exchange and Foreign trade act, please consult with ROHM in case of export.

**Precaution Regarding Intellectual Property Rights**

1. All information and data including but not limited to application example contained in this document is for reference only. ROHM does not warrant that foregoing information or data will not infringe any intellectual property rights or any other rights of any third party regarding such information or data.
2. ROHM shall not have any obligations where the claims, actions or demands arising from the combination of the Products with other articles such as components, circuits, systems or external equipment (including software).
3. No license, expressly or implied, is granted hereby under any intellectual property rights or other rights of ROHM or any third parties with respect to the Products or the information contained in this document. Provided, however, that ROHM will not assert its intellectual property rights or other rights against you or your customers to the extent necessary to manufacture or sell products containing the Products, subject to the terms and conditions herein.

**Other Precaution**

1. This document may not be reprinted or reproduced, in whole or in part, without prior written consent of ROHM.
2. The Products may not be disassembled, converted, modified, reproduced or otherwise changed without prior written consent of ROHM.
3. In no event shall you use in any way whatsoever the Products and the related technical information contained in the Products or this document for any military purposes, including but not limited to, the development of mass-destruction weapons.
4. The proper names of companies or products described in this document are trademarks or registered trademarks of ROHM, its affiliated companies or third parties.

**General Precaution**

1. Before you use our Products, you are requested to carefully read this document and fully understand its contents. ROHM shall not be in any way responsible or liable for failure, malfunction or accident arising from the use of any ROHM's Products against warning, caution or note contained in this document.
2. All information contained in this document is current as of the issuing date and subject to change without any prior notice. Before purchasing or using ROHM's Products, please confirm the latest information with a ROHM sales representative.
3. The information contained in this document is provided on an "as is" basis and ROHM does not warrant that all information contained in this document is accurate and/or error-free. ROHM shall not be in any way responsible or liable for any damages, expenses or losses incurred by you or third parties resulting from inaccuracy or errors of or concerning such information.