

Hardware Reference Manual

REV. July 2017

Raven (VL-EPU-3312)

Intel® Atom™ E38xx-based
Embedded Processing Unit with
SATA, Dual Ethernet, USB,
Digital I/O, Serial, Video, Mini
PCIe Sockets, SPX, Trusted
Platform Module, and microSD.



VERSALOGIC
CORPORATION



WWW.VERSALOGIC.COM

12100 SW Tualatin Road
Tualatin, OR 97062-7341
(503) 747-2261
Fax (971) 224-4708

Copyright © 2016-2017 VersaLogic Corp. All rights reserved.

Notice:

Although every effort has been made to ensure this document is error-free, VersaLogic makes no representations or warranties with respect to this product and specifically disclaims any implied warranties of merchantability or fitness for any particular purpose.

VersaLogic reserves the right to revise this product and associated documentation at any time without obligation to notify anyone of such changes.

* Other names and brands may be claimed as the property of others.

Product Revision Notes

Revision 1.3	<ul style="list-style-type: none">• Updated Web links
Revision 1.2	<ul style="list-style-type: none">• Updated Integrator's note on page 32
Revision 1.1	<ul style="list-style-type: none">• Updated board images• Revised audio content• Updated Mini DisplayPort cable information
Revision 1.00	<ul style="list-style-type: none">• First release

Support Page

The [Raven Support Page](#) contains additional information and resources for this product including:

- Operating system information and software drivers
- Data sheets and manufacturers links for chips used in this product
- BIOS information and upgrades

VersaTech KnowledgeBase

The [VersaTech KnowledgeBase](#) contains useful technical information about VersaLogic products, along with product advisories.

Customer Support

If you are unable to solve a problem after reading this manual, visiting the product support page, or searching the KnowledgeBase, contact VersaLogic Technical Support at (503) 747-2261. VersaLogic support engineers are also available via e-mail at Support@VersaLogic.com.

Repair Service

If your product requires service, you must obtain a Returned Material Authorization (RMA) number by calling 503-747-2261. Be ready to provide the following information:

- Your name, the name of your company, your phone number, and e-mail address
- The name of a technician or engineer that can be contacted if any questions arise
- The quantity of items being returned
- The model and serial number (barcode) of each item
- A detailed description of the problem
- Steps you have taken to resolve or recreate the problem
- The return shipping address

Warranty Repair

All parts and labor charges are covered, including return shipping charges for UPS Ground delivery to United States addresses.

Non-warranty Repair All approved non-warranty repairs are subject to diagnosis and labor charges, parts charges and return shipping fees. Specify the shipping method you prefer and provide a purchase order number for invoicing the repair.



Note:

Mark the RMA number clearly on the outside of the box before returning.

Cautions

Electrostatic Discharge



CAUTION:

Electrostatic discharge (ESD) can damage circuit boards, disk drives, and other components. The circuit board must only be handled at an ESD workstation. If an approved station is not available, some measure of protection can be provided by wearing a grounded antistatic wrist strap. Keep all plastic away from the board, and do not slide the board over any surface.

After removing the board from its protective wrapper, place the board on a grounded, static-free surface, component side up. Use an antistatic foam pad if available.

The board should also be protected inside a closed metallic antistatic envelope during shipment or storage.



Note:

The exterior coating on some metallic antistatic bags is sufficiently conductive to cause excessive battery drain if the bag comes in contact with the bottom side of the Raven.

Handling Care



CAUTION:

Avoid touching the exposed circuitry with your fingers when handling the board. Though it will not damage the circuitry, it is possible that small amounts of oil or perspiration on the skin could have enough conductivity to cause the contents of CMOS RAM to become corrupted through careless handling, resulting in CMOS resetting to factory defaults.

Earth Ground Requirement



CAUTION:

All mounting standoffs should be connected to earth ground (chassis ground). This provides proper grounding for EMI purposes.

Contents

Cautions	4
Electrostatic Discharge	4
Handling Care	4
Earth Ground Requirement.....	4
Introduction	9
Features.....	10
Technical Specifications.....	10
Block Diagram.....	11
Dimensions and Mounting.....	12
Raven Dimensions	12
Mounting Plate Dimensions	13
Configuration and Setup.....	14
Initial Configuration	14
Basic Setup	14
BIOS Setup Utility.....	16
Default BIOS Setup Values	16
Operating System Installation.....	16
Jumper Blocks	17
Jumper As-Shipped Configuration	17
Jumper Configuration Summary.....	17
Board Features	18
CPU.....	18
CPU Die Temperature	18
System RAM.....	18
Flash Storage	18
I/O Interfaces	19
Real-Time Clock (RTC)	19
Watchdog Timer	19
External Connectors	20
Baseboard Connector Locations.....	20
Power Delivery	21
Main Power Connector	21
Cabling.....	22
Power Requirements.....	22
Power Delivery Considerations	22
Power Button	23
Supported Power States.....	23
Battery Power Options.....	24
External Speaker.....	25
Push-button Reset	25
CPU Fan Connector.....	26
Cabling.....	26
LEDs	27

Power-Good/Fault Indicator LEDs.....	28
Mass Storage Interfaces	29
SATA Interface.....	29
microSD Socket.....	30
eMMC Flash.....	30
Multi-purpose I/O.....	31
USB Interfaces.....	31
Mini PCIe Sockets.....	32
W_DISABLE# Signal.....	34
Mini PCIe Card Wireless Status LEDs.....	35
mSATA Activity LED.....	36
User I/O Connector.....	37
Cabling.....	38
Analog-to-Digital Converter Interface.....	39
Cabling.....	40
SPX* Expansion Bus.....	41
Cabling.....	42
Serial I/O	43
Serial Ports.....	43
Serial Port Connector Pinout.....	44
Cabling.....	44
COM Port Configuration.....	45
Console Redirection.....	45
Video Interfaces.....	46
Mini DisplayPort++ Connector.....	46
VGA Output.....	48
Mini DisplayPort Cable Options.....	48
LVDS Interface.....	49
LVDS Flat Panel Display Connector.....	49
LVDS Backlight Connector.....	51
Network Interfaces	52
Ethernet Connector.....	52
Cabling.....	53
Ethernet Status LEDs.....	54
VL-CBR-4005B Paddleboard.....	55
VL-CBR-4005B Connectors and Indicators.....	55
User I/O Connector.....	56
Cabling.....	57
On-board Battery.....	57
Auxiliary I/O Connector.....	58
Dimensions and Mounting Holes.....	59
VL-CBR-2004B Paddleboard.....	60
Analog Input Connections.....	60
Main I/O Connector.....	61
Cabling.....	61

Dimensions and Mounting Holes	62
Thermal Considerations	63
Selecting the Correct Thermal Solution for Your Application	63
Heat Plate.....	63
System-level Considerations	63
CPU Thermal Trip Points	64
Thermal Specifications, Restrictions, and Conditions	66
Overall Restrictions and Conditions:.....	66
Heat Plate Only Restrictions and Conditions:	66
Heat Sink Only Considerations:	66
Heat Sink with Fan Considerations:	66
EPU-3312 Thermal Characterization	67
Test Results.....	68
Installing VersaLogic Thermal Solutions.....	72
Hardware Assembly.....	72
Installing the VL-HDW-406 Passive Heat Sink	73
Installing the VL-HDW-415 Heat Sink Fan	75
Installing the VL-HDW-408 Heat Pipe Block.....	76
KNOWN ISSUES	77

Figures

Figure 1. The Raven (VL-EPU-3312)	9
Figure 2. Raven (VL-EPU-3312) Block Diagram	11
Figure 3. Raven Dimensions and Mounting Holes	12
Figure 4. Mounting Plate Dimensions	13
Figure 5. Typical Development Configuration	15
Figure 6. Jumpers As-Shipped Configuration.....	17
Figure 7. Baseboard Connector Locations.....	20
Figure 8. Main Power Connector Pin Orientation	21
Figure 9. Location and Pin Orientation of the Battery Connector	24
Figure 10. VL-CBR-0203 Latching Battery Module.....	25
Figure 11. Location and Pin Orientation of the CPU Fan Connector	26
Figure 12. Location of Status Indicator LEDs	27
Figure 13. Location of the Power-good/Fault Indicator LED	28
Figure 14. Location of the SATA Connector	29
Figure 15. Location of the microSD Socket	30
Figure 16. Location of the USB Ports	31
Figure 17. Location of Mini PCIe Sockets	32
Figure 18. Mini PCIe Wireless Status LEDs	35
Figure 19. Location of the SATA/mSATA Activity LED	36
Figure 20. Location and Pin Orientation of the User I/O Connector	37
Figure 21. Location and Pin Orientation of the Analog-to-Digital Input Connector	39
Figure 22. SPX Connector Location and Pin Configuration	41
Figure 23. Location and Pin Orientation of the Serial I/O Connectors.....	43
Figure 24. Location of the Mini DisplayPort++ Connector.....	47
Figure 25. VL-CBR-2032 Mini DisplayPort to VGA Adapter.....	48
Figure 26. Location of the LVDS Connectors	49
Figure 27. Location and Pin Orientation of the Ethernet Connector	52

Figure 28. Onboard Ethernet Status LEDs	54
Figure 29. VL-CBR-4005B Connectors, Switches, and LEDs	55
Figure 30. Location and Pin Orientation of the User I/O Connector	56
Figure 31. Location and Pin Orientation of Auxiliary I/O Connector	58
Figure 32. VL-CBR-4005B Dimensions and Mounting Holes	59
Figure 33. CBR-2004B Connectors.....	60
Figure 34. Analog Input and Ground Terminal Block Pinouts	60
Figure 35. Location and Pin Orientation of the Main I/O Connector	61
Figure 36. CBR-2004B Dimensions and Mounting Holes	62
Figure 37. EPU-3312-EAP Single Core Temperature Relative to Ambient Temperature.....	68
Figure 38. EPU-3312-EBP Dual Core Temperature Relative to Ambient Temperature	69
Figure 39. EPU-3312-EDP Quad Core Temperature Relative to Ambient Temperature	70
Figure 40. EPU-3312-EDP Quad Core with Heat Pipe - Temperature Relative to Ambient.....	71
Figure 41. Hardware Assembly with Heat Plate Down	72
Figure 42. Hardware Assembly with Heat Plate Up	73
Figure 43. Installing the Passive Heat Sink	74
Figure 44. Installing the Heat Sink Fan	75
Figure 45. Installing the Heat Pipe Block.....	76

Tables

Table 1: Jumper Block Configurations.....	17
Table 2: Raven Memory Characteristics	18
Table 3: Links to Sections Describing Connectors.....	20
Table 4: Main Power Connector Pinout	22
Table 5: Supported Power States.....	23
Table 6: CPU Fan Connector Pinout	26
Table 7: Mini PCIe / mSATA Socket Pinout	33
Table 8: Mini PCIe Card Wireless Status LEDs	35
Table 9: User I/O Connector Pinout and Pin Orientation	38
Table 10: Analog-to-Digital Input Connector Pinout	40
Table 11: SPX Connector Pinout	42
Table 12: COM1/COM2 Connector Pinout.....	44
Table 13: COM3/COM4 Connector Pinout.....	44
Table 14: Mini DisplayPort++ Connector Pinout.....	47
Table 15: LVDS Flat Panel Display Connector Pinout	50
Table 16: LVDS Backlight Connector Pinout	51
Table 17: Ethernet Connector Pinout	53
Table 18: User I/O Connector Pinout.....	56
Table 19: Auxiliary I/O Connector Pinout	58
Table 20: Main I/O Connector Pinout	61
Table 21: CPU Thermal Trip Points.....	64
Table 22: Temperature Monitoring Programs	65
Table 23: Absolute Minimum and Maximum Air Temperatures.....	66
Table 24: EPU-3312 Thermal Testing Setup	67
Table 25: Heat Pipe Additional Configuration Details.....	71

Introduction

1

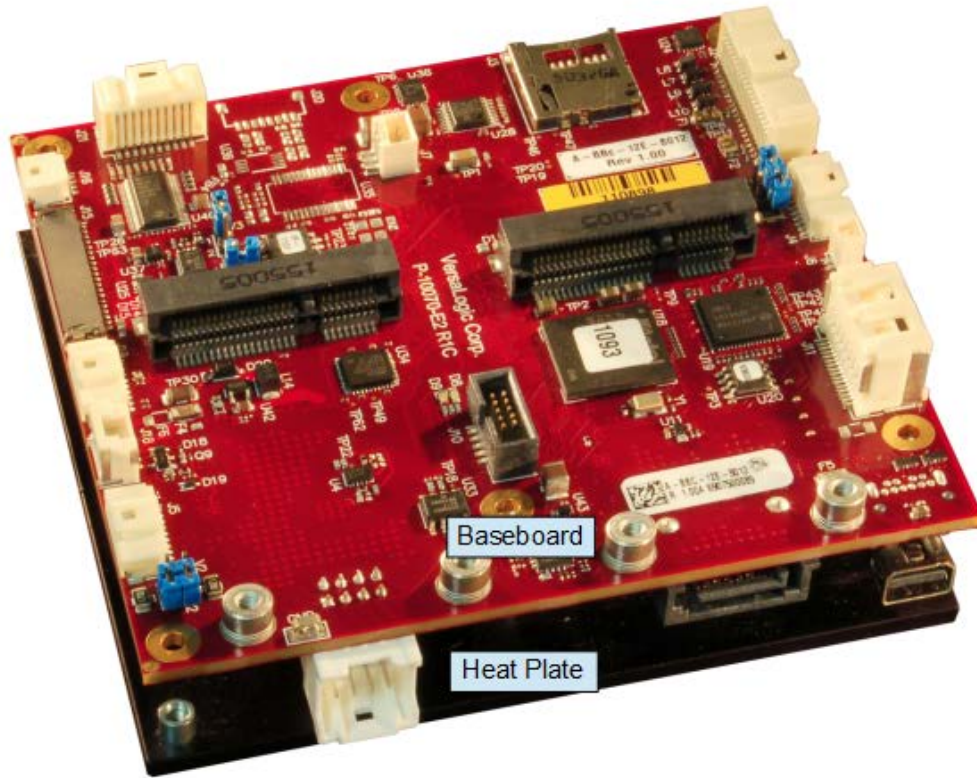

Figure 1. The Raven (VL-EPU-3312)

Features

The Raven (VL-EPU-3312) is a feature-packed Embedded Processing Unit (EPU) engineered and tested to meet the embedded industry's evolving requirements to develop smaller, lighter, and lower power embedded systems while adhering to stringent regulatory standards.

This embedded computer, equipped with an Intel® Atom® 38xx processor, is designed to withstand extreme temperature, impact, and vibration. Its features include:

- Intel Atom E3845 (1.91 GHz, Quad Core), E3827 (1.75 GHz, Dual Core), or E3815 (1.46 GHz, Single Core) processor
- 4 GB or 2GB soldered-on DDR3L-1333 RAM
- Two auto-detect 10BaseT/100BaseTX/1000BaseT Ethernet ports with network boot support (Port 1 only)
- Integrated Intel Gen 7 graphics core
- Four USB 2.0 host ports, one USB 3.0/2.0 port, one port available through Mini PCIe Socket #1
- Four RS-232/422/485 COM ports
- One Mini DisplayPort++ interface
- One LVDS interface
- Wide input voltage range (8 – 30V)
- Input under-voltage and over-voltage protection
- Eight multi-range analog inputs
- I²C support
- Two Mini PCIe sockets
- Full ACPI support
- One SATA port, 3.0 Gbits/s
- One microSD socket
- Watchdog Timer, prescaler of approximately 1 μs to 10 minutes.
- Standard heat plate with optional thermal solutions
- Optional mounting plate
- Field upgradeable AMI UEFI BIOS with enhancements
- RoHS compliant
- Extended temperature operation
- Customization available
- Trusted Platform Module

The Raven is compatible with popular operating systems including Microsoft® Windows® 7/WES7, and Linux (see the [VersaLogic OS Compatibility Chart](#)).

Raven EPUs receive 100% functional testing and are backed by a limited five-year warranty. Careful parts sourcing and US-based technical support ensure the highest possible quality, reliability, service, and product longevity for this exceptional EPU.

Technical Specifications

Refer to the [Raven Data Sheet](#) for complete specifications. Specifications are subject to change without notification.

Block Diagram

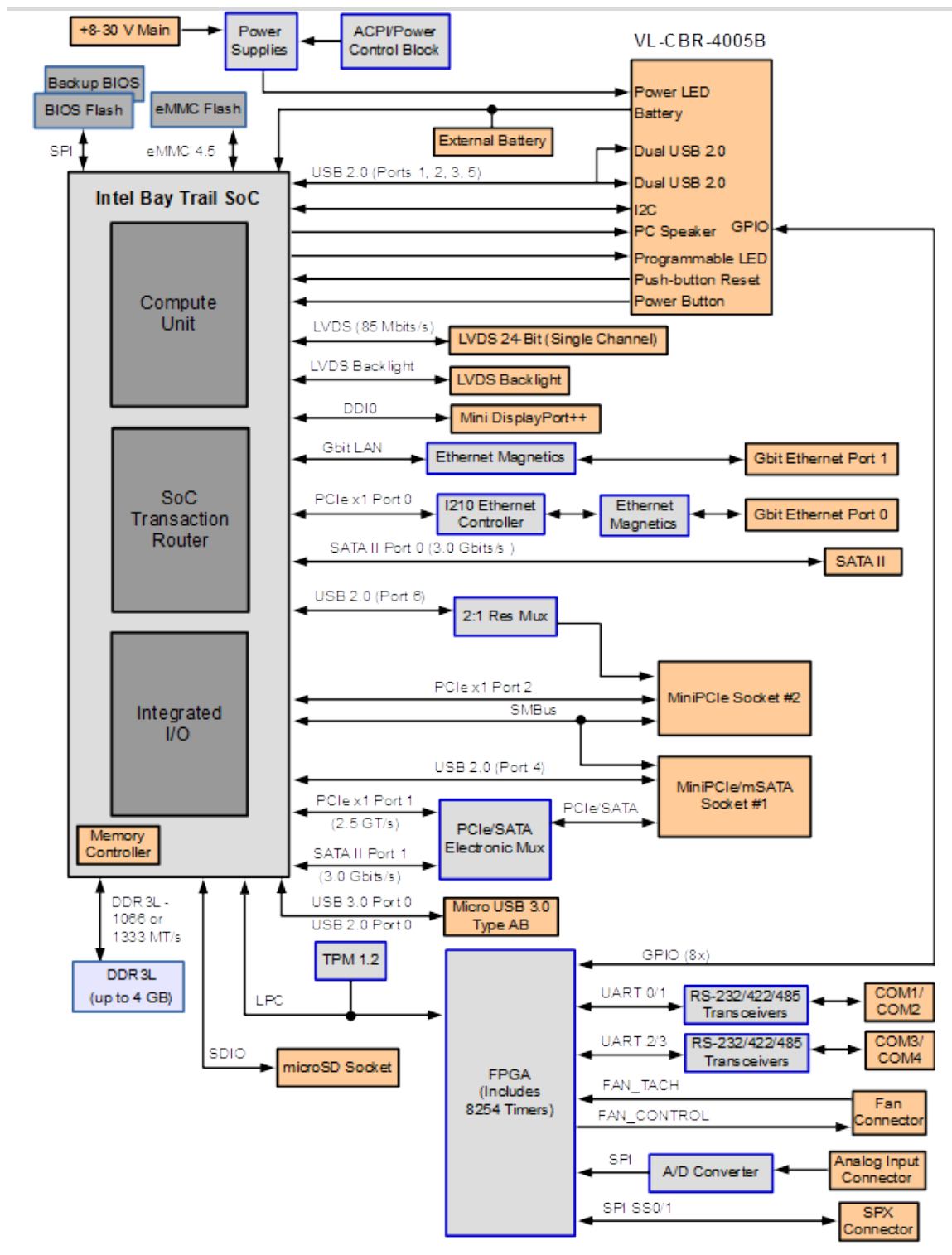
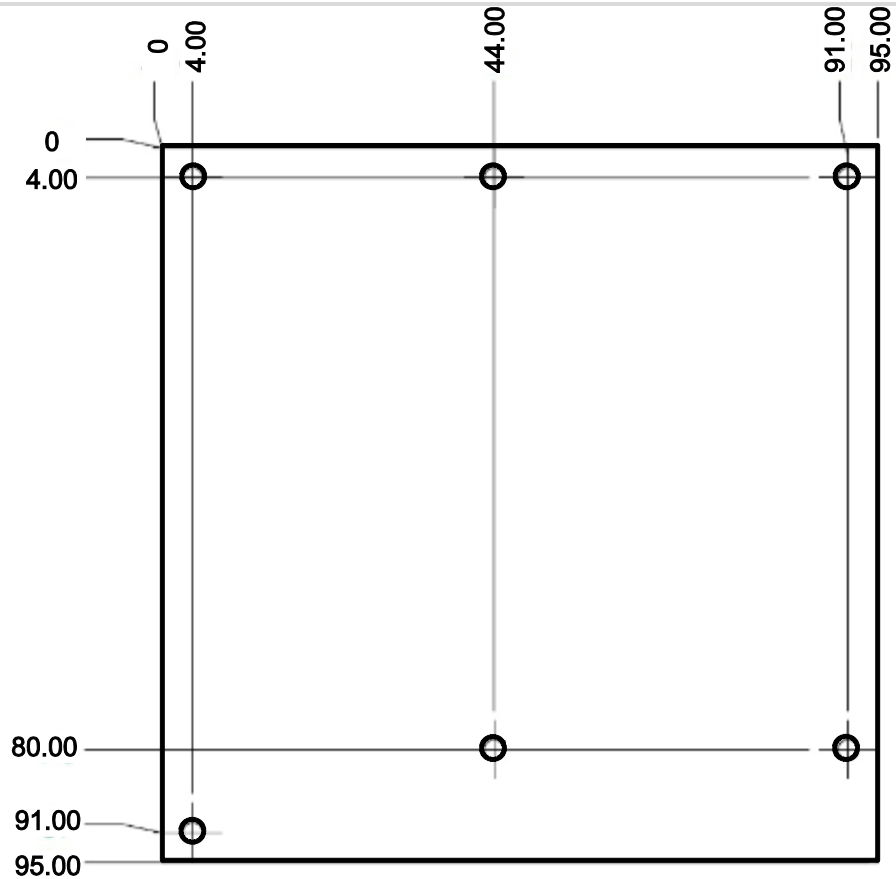

Figure 2. Raven (VL-EPU-3312) Block Diagram

Dimensions and Mounting

Raven Dimensions

Figure 3 provides the board's dimensions.



EPU3312_06

Figure 3. Raven Dimensions and Mounting Holes

(Not to scale. All dimensions in millimeters.)

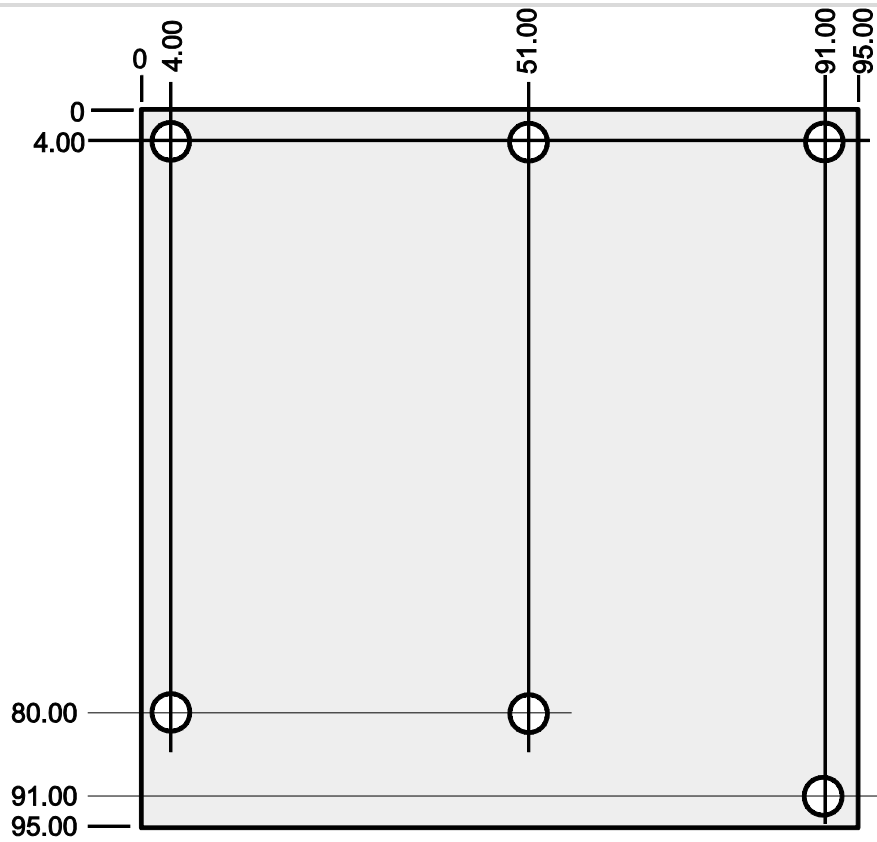
Mounting Plate Dimensions

EPU3312_39

Figure 4. Mounting Plate Dimensions
(Not to scale. All dimensions in millimeters.)

Configuration and Setup

2

Initial Configuration

The following components are recommended for a typical development system with the Raven EPU:

- ATX power supply
- VL-CBR-4005B paddleboard and VL-CBR-4005A cable. Refer to the chapter titled “VL-CBR-4005B Paddleboard”, beginning on page 55 for details on the VL-CBR-4005B paddleboard.
- USB keyboard and mouse
- SATA hard drive
- USB CD-ROM drive
- VGA monitor and a VL-CBR-2032 Mini DisplayPort-to-VGA adapter
- A thermal solution (using either VersaLogic accessories or a customer-designed solution)

You will also need an operating system (OS) installation CD-ROM.

Basic Setup

The following steps outline the procedure for setting up a typical development system. The Raven should be handled at an ESD workstation or while wearing a grounded antistatic wrist strap.

Before you begin, unpack the Raven and accessories. Verify that you received all the items you ordered. Inspect the system visually for any damage that may have occurred in shipping. Contact Support@VersaLogic.com immediately if any items are damaged or missing.

Gather all the peripheral devices you plan to attach to the Raven as well as their interface and power cables. Attach standoffs to the board to stabilize it and make it easier to work with.

Figure 5 shows a typical setup for the Raven in the development environment.

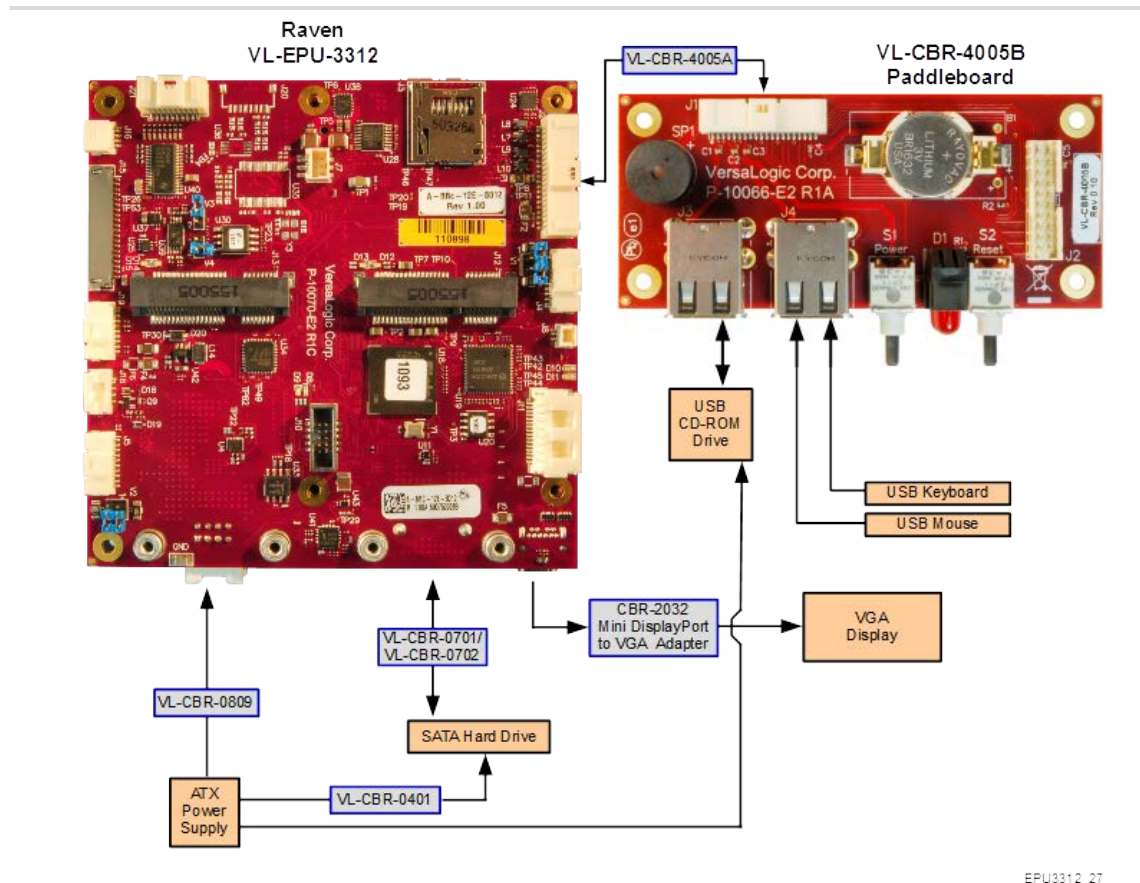

EPU3312_27

Figure 5. Typical Development Configuration

1. Attach Cables and Peripherals

- Attach a VGA monitor to the baseboard's Mini DisplayPort++ connector using a VL-CBR-2032.
- Attach a SATA hard disk to the baseboard's SATA connector using a VL-CBR-0701 or VL-CBR-0702 cable.
- Attach a VL-CBR-4005B paddleboard to the baseboard's User I/O connector.
- Connect a USB keyboard and USB mouse to the USB Type-A connectors on the VL-CBR-4005B paddleboard.
- Attach a USB CD-ROM drive to one of the USB Type-A connectors on the VL-CBR-4005B paddleboard.

2. Connect Power Source

- Plug the power adapter cable VL-CBR-0809 into the main power connector on the baseboard. Attach the motherboard connector of the ATX power supply to the adapter.
- Attach an ATX power cable to any 3.5-inch drive that is not already attached to the power supply (hard drive or CD-ROM drive).

3. Review Configuration

- Before you power up the system, double-check all the connections. Make sure all cables are oriented correctly, that adequate power is supplied to the Raven and all attached peripheral devices.

4. Power On

- Turn on the ATX power supply and the video monitor. If the system is correctly configured, a video signal should be present.

5. Install Operating System

- Install the operating system according to the instructions provided by the operating system manufacturer.

BIOS Setup Utility

Refer to the [VersaLogic System Utility Reference Manual](#) for information on how to configure the Raven BIOS.

The Raven permits you to store user-defined BIOS settings. This enables you to retrieve those settings from cleared or corrupted CMOS RAM, or battery failure. All BIOS defaults can be changed, except the time and date. BIOS defaults can be updated with the BIOS Update Utility.



CAUTION: If BIOS default settings make the system unbootable and prevent the user from entering the BIOS Setup utility, the Raven must be serviced by the factory.

Default BIOS Setup Values

After CMOS RAM clears, the system loads default BIOS parameters the next time the board powers on. The default CMOS RAM setup values are used in order to boot the system whenever the main CMOS RAM values are blank, or when the system battery is dead or has been removed from the board.

Operating System Installation

The standard PC architecture used on the Raven makes the installation and use of most of the standard x86-based operating systems very simple. The operating systems listed on the [VersaLogic Software Support](#) page use the standard installation procedures provided by the maker of the operating system. Special optimized hardware drivers for a particular operating system, or a link to the drivers, are available on the [Raven Support Page](#).

Jumper Blocks

Jumper As-Shipped Configuration

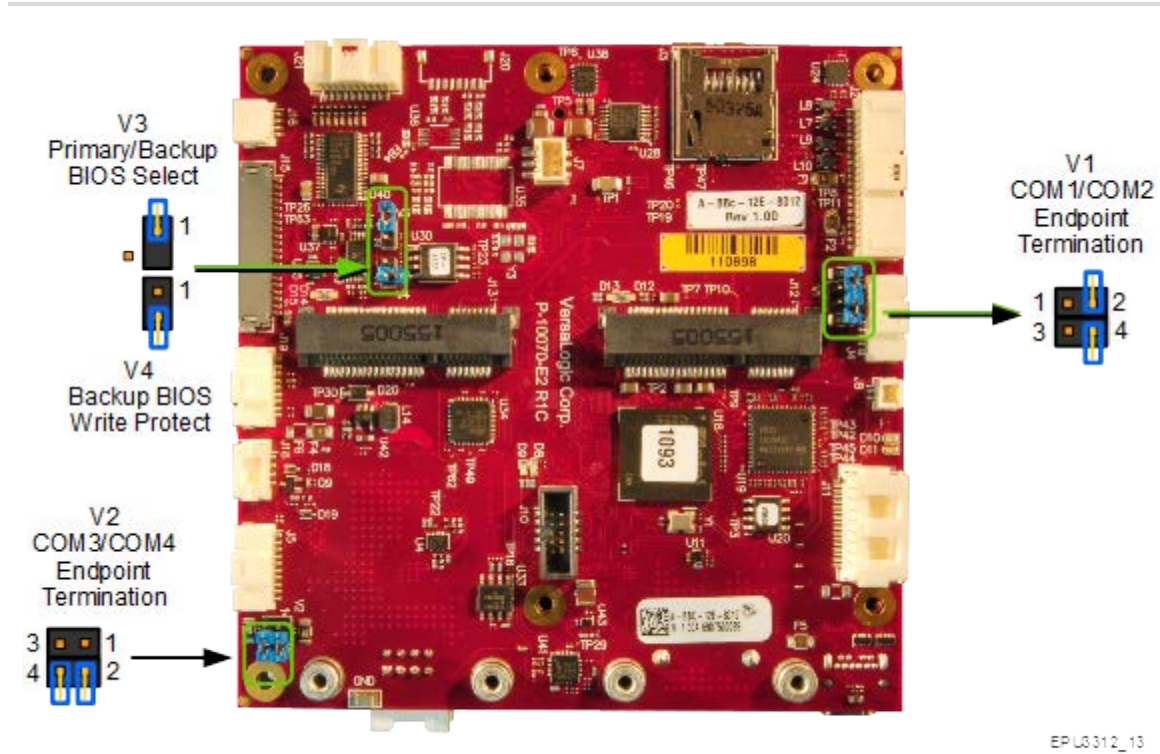

Figure 6. Jumpers As-Shipped Configuration

Jumper Configuration Summary

Table 1: Jumper Block Configurations

Jumper Block	Pins	Function	Description
V1	1-2	COM2 Endpoint Termination	<ul style="list-style-type: none"> Jumper In: Endpoint termination (for RS-485 or RS-422) Jumper Out: Not terminated (RS-232) (default)
	3-4	COM1 Endpoint termination	<ul style="list-style-type: none"> Jumper In: Endpoint termination (for RS-485 or RS-422) Jumper Out: Not terminated (RS-232) (default)
V2	1-2	COM3 Endpoint Termination	<ul style="list-style-type: none"> Jumper In: Endpoint termination (for RS-485 or RS-422) Jumper Out: Not terminated (RS-232) (default)
	3-4	COM4 Endpoint termination	<ul style="list-style-type: none"> Jumper In: Endpoint termination (for RS-485 or RS-422) Jumper Out: Not terminated (RS-232) (default)
V3	1-2	Primary/Backup BIOS Select	<ul style="list-style-type: none"> Jumper In: Use Backup BIOS Jumper Out: Use Primary BIOS (default)
V4	1-2	Backup BIOS Write Protect	<ul style="list-style-type: none"> Jumper In: Backup BIOS is write-protected Jumper Out: Backup BIOS is not write-protected (default)

Board Features

3

CPU

The Intel Atom E38xx SoC features integrated 3D graphics, video encode and decode, and memory and display controllers in one package. The following CPU configurations are available:

- VL-EPU-3312-EAP: Intel Atom 3815 – 1.46 GHz, Single Core
- VL-EPU-3312-EBP: Intel Atom 3827 – 1.75 GHz, Dual Core
- VL-EPU-3312-EDP: Intel Atom 3845 – 1.91 GHz, Quad Core

CPU Die Temperature

The CPU die temperature is affected by numerous conditions, such as CPU utilization, CPU speed, ambient air temperature, airflow, thermal effects of adjacent circuit boards, external heat sources, and many others.

The thermal management for the Intel Atom E38xx series of processors consists of a sensor located in the core processor area. The processor contains multiple techniques to help better manage thermal attributes of the processor. It implements thermal-based clock throttling and thermal-based speed step transitions. There is one thermal sensor on the processor that triggers Intel's thermal monitor (the temperature at which the thermal sensor triggers the thermal monitor is set during the fabrication of the processor). Triggering of this sensor is visible to software by means of the thermal interrupt LVT entry in the local APIC. (See the [Intel Atom Processor E3800 Series Datasheet](#) for complete information.)

System RAM

The Raven has soldered-on SDRAM with the following characteristics:

Table 2: Raven Memory Characteristics

Board Model	Memory Type	Capacity	Data Rate
VL-EPU-3312-EAP	DDR3L	2 GB	1066 MT/s – Single Channel
VL-EPU-3312-EBP	DDR3L	2 GB	1333 MT/s – Dual Channel
VL-EPU-3312-EDP	DDR3L	4 GB	1333 MT/s – Dual Channel

Flash Storage

The Raven provides on-board eMMC* Flash storage on certain models of the product:

- VL-EPU-3312-EAP: none
- VL-EPU-3312-EBP: 4 GB
- VL-EPU-3312-EDP: 8 GB

I/O Interfaces

Later chapters describe the Raven's I/O interfaces and their associated connectors as follows:

- Mass Storage Interfaces (SATA, microSD, and eMMC Flash), beginning on page 29
- Multi-purpose I/O (USB, Mini PCIe / mSATA, User I/O), beginning on page 31
- Serial I/O, beginning on page 43
- Video Interfaces (Mini DisplayPort++ and LVDS), beginning on page 46
- Network Interfaces, beginning on page 52

Real-Time Clock (RTC)

The Raven features a real-time clock/calendar (RTC) circuit. The Raven supplies RTC voltage in S5, S3, and S0 states, but requires an external +2.75 V to +3.3 V battery connection. Refer to the section titled Battery Power Options on page 24 for more information. The BIOS Setup utility sets the RTC.

Watchdog Timer

The Raven has a watchdog timer that contains a selectable pre-scaler approximately 1 as to 10 minutes. The BIOS Setup utility configures the watchdog timer.

External Connectors

Baseboard Connector Locations

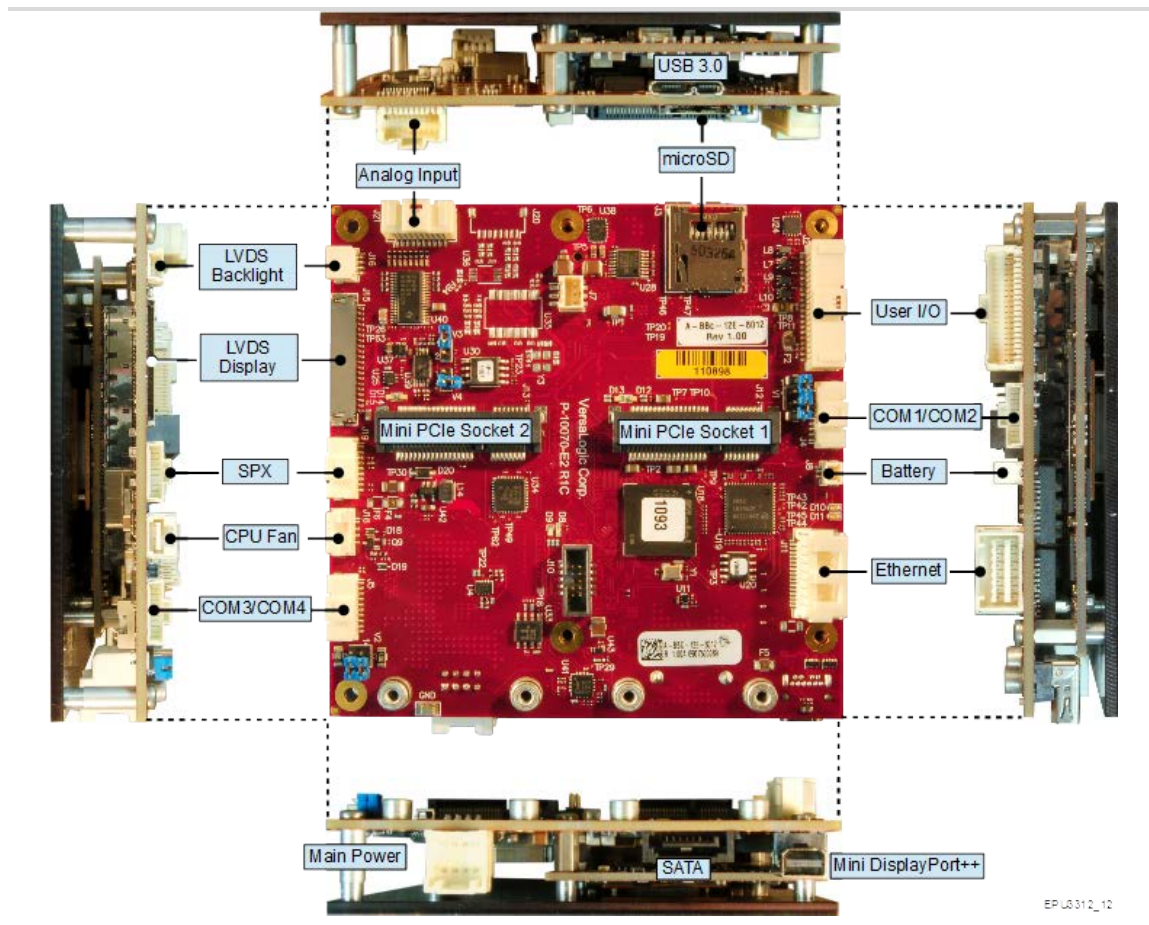

Figure 7. Baseboard Connector Locations

Table 3: Links to Sections Describing Connectors

• Analog input – page 39	• Main Power – page 21
• Battery – page 24	• microSD – page 30
• COM1/COM2 – page 43	• Mini DisplayPort++ – page 46
• COM3/COM4 – page 43	• Mini PCIe Sockets 1 and 2 – page 32
• CPU Fan – page 26	• SATA – page 29
• Ethernet – page 52	• SPX – page 41
• LVDS Backlight – page 51	• USB 3.0 – page 31
• LVDS Display – page 49	• User I/O – page 56

Power Delivery

Main Power Connector

An 8-pin power connector applies the Main input power to the Raven. Figure 8 shows the location and the pin orientation of the main power connector. Table 4 lists the pinout of the main power connector.

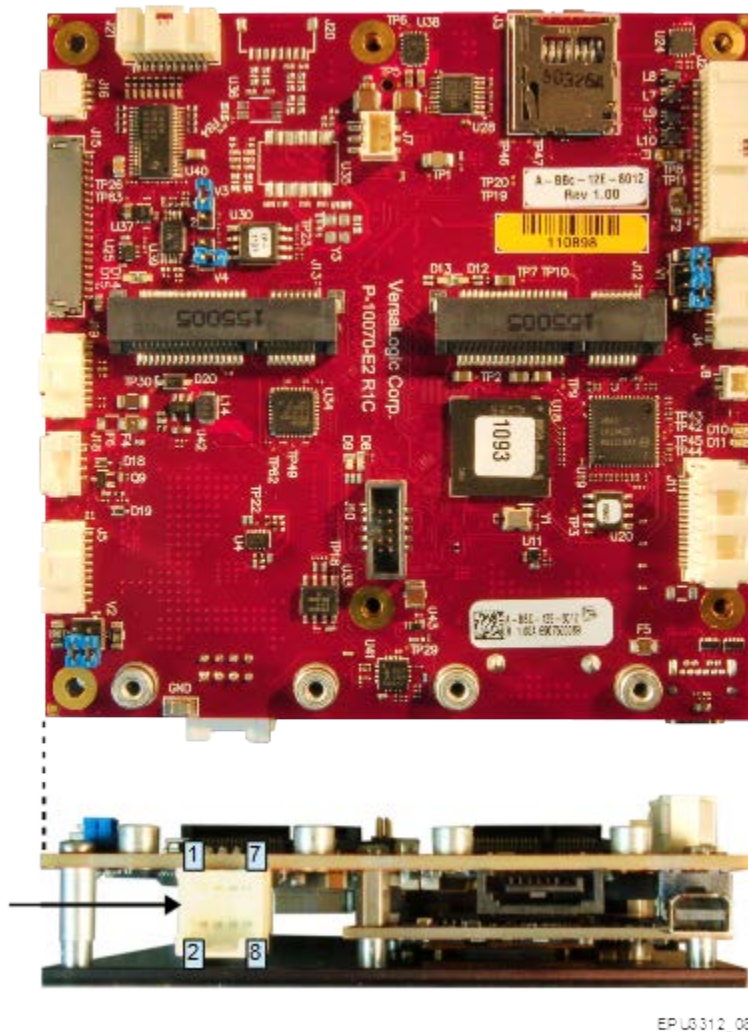

EPU3312_08

Figure 8. Main Power Connector Pin Orientation

Table 4: Main Power Connector Pinout

Pin	Signal	Description	Pin	Signal	Description
1	V_MAIN	Main input voltage (+8V to +30V)	2	V_MAIN	Main input voltage (+8V to +30V)
3	EARTH_GND	Earth ground	4	V_MAIN	Main input voltage (+8V to +30V)
5	POWER_FAULT	An open-drain signal <ul style="list-style-type: none"> Low if power is OK Open if there is a power fault (Note) 	6	GND	Signal ground
7	GND	Signal ground	8	GND	Signal ground

Note: A power fault can be due any of the following conditions:

- The input power is off.
- The main input regulator has failed.
- The power input is under- or over-voltage (not in the 8 - 30V range) .

Cabling

An adapter cable, part number VL-CBR-0809, is available for connecting the Raven to an ATX power supply.

If your application requires a custom cable, the following information will be useful:

VL-EPU-3312 Board Connector	Mating Connector
Molex 055959-0830	Molex 051353-0800

Power Requirements

The Raven requires a single +8 to +30 VDC supply capable of providing at least 35 W average power that can also provide a peak power of 50 W. The input DC supply creates both the standby and payload voltages provided to the CPU module.

The exact power requirements for the Raven depend on several factors, including CPU configuration (the number of cores, CPU clock rate), memory configuration, peripheral connections, and attached devices, and others. For example, driving long RS-232 lines at high speed can increase power demand.

The VersaLogic VL-PS-ATX12-300A is a 1U size ATX power supply suitable for use with the Raven. Use the VL-CBR-0809 adapter cable to attach the power supply to the main power connector.

Power Delivery Considerations

Using the VersaLogic approved power supply (VL-PS-ATX12-300A) and power cable (VL-CBR-0809) will ensure high quality power delivery to the board. Customers who design their own power delivery methods should take into consideration the guidelines below to ensure good power connections.

The specifications for typical operating current do not include any off-board power usage that fed through the Raven power connector. Expansion boards and USB devices plugged into the board will source additional power through the Raven power connector.

- Do not use wire smaller than 22 AWG. Use high quality UL 1007 compliant stranded wire.
- The length of the wire should not exceed 18 inches.
- Avoid using any additional connectors in the power delivery system.
- The power and ground leads should be twisted together, or as close together as possible to reduce lead inductance.
- A separate conductor must be used for each of the power pins.
- All power input pins and all ground pins must be independently connected between the power source and the power connector.
- Use a high quality power supply that can supply a stable voltage while reacting to widely varying current draws.

Power Button

The User I/O connector (shown in Figure 20 on page 37) includes an input for a power button. A momentary short to ground or assertion of pin 17 will cause a power button ACPI event. The button event can be configured in Windows to enter an S3 power state (Sleep, Standby, or Suspend-to-RAM), an S4 power state (Hibernate or Suspend-to-Disk), or an S5 power state (Shutdown or Soft-Off). This connector uses IEC 61000-4-2-rated TVS components to help protect against ESD damage.

A power button is provided on the VL-CBR-4005B paddleboard. Refer to the chapter titled VL-CBR-4005B Paddleboard, beginning on page 55 for more information.

Supported Power States

Table 5 lists the Raven's supported power states.

Table 5: Supported Power States

Power state	Description
S0 (G0)	Working
S1 (G1-S1)	All processor caches are flushed and the CPUs stop executing instructions. Power to the CPUs and RAM is maintained. Devices that do not indicate they must remain on may be powered down.
S3 (G1-S3)	Commonly referred to as Standby, Sleep, or Suspend-to-RAM. RAM remains powered.
S4 (G1-S4)	Hibernation or Suspend-to-Disk. All content of main memory is saved to non-volatile memory, such as a hard drive, and is powered down.
S5 (G2)	Soft Off. Almost the same as G3 Mechanical Off, except that the power supply still provides power, at a minimum, to the power button to allow return to S0. A full reboot is required. No previous content is retained. Other components may remain powered so the computer can "wake" on input from the keyboard, clock, modem, LAN, or USB device.
G3	Mechanical off (ATX supply switch turned off).

Battery Power Options

The battery circuit on the Raven provides power for the Real-Time Clock (RTC) and power to store BIOS Setup utility settings in non-volatile RAM.

The Raven has multiple options for providing battery power:

- Use an external battery (the VL-CBR-0203, for example) connected to the board through the battery connector.
- Use the battery supplied with the CBR-4005B paddleboard

Figure 9 shows the location and pin orientation of the battery connector.

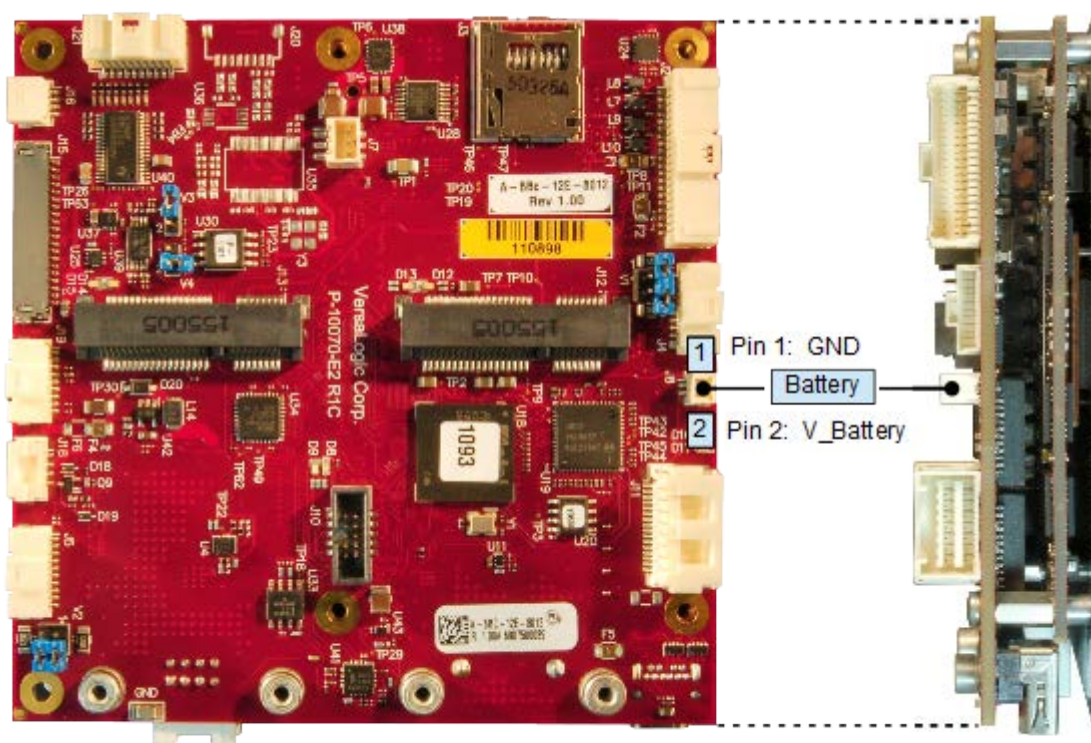

EPU3312_2

Figure 9. Location and Pin Orientation of the Battery Connector

Cabling

If your application requires a custom cable, the following information will be useful:

VL-EPU-3312 Board Connector	Mating Connector
Molex 501331-0207	Molex 501330-0200

VL-CBR-0203 External Battery Module

The VL-CBR-0203 external battery module is compatible with the Raven. For more information, contact Sales@VersaLogic.com.



Figure 10. VL-CBR-0203 Latching Battery Module

External Speaker

The User I/O connector (shown in Figure 20 on page 37) includes a speaker output signal at pin 15. The VL-CBR-4005B paddleboard provides a piezoelectric speaker. Figure 29 on page 55 shows the location of the piezoelectric speaker on the VL-CBR-4005B paddleboard.

Push-button Reset

The User I/O connector (shown in Figure 20 on page 37) includes an input for a push-button reset switch. Shorting pin 18 to ground causes the Raven to reboot. This must be a mechanical switch or an open-collector or open-drain active switch with less than a 0.5V low-level input when the current is 1 mA. There must be no pull-up resistor on this signal. This connector uses IEC 61000-4-2-rated TVS components to help protect against ESD damage.

A reset button on the VL-CBR-4005B paddleboard is provided. Refer to the chapter titled VL-CBR-4005B Paddleboard, beginning on page 55 for more information.

CPU Fan Connector

The Raven provides a four-pin CPU fan connector. Figure 11 shows the location and pin orientation of the CPU fan connector.

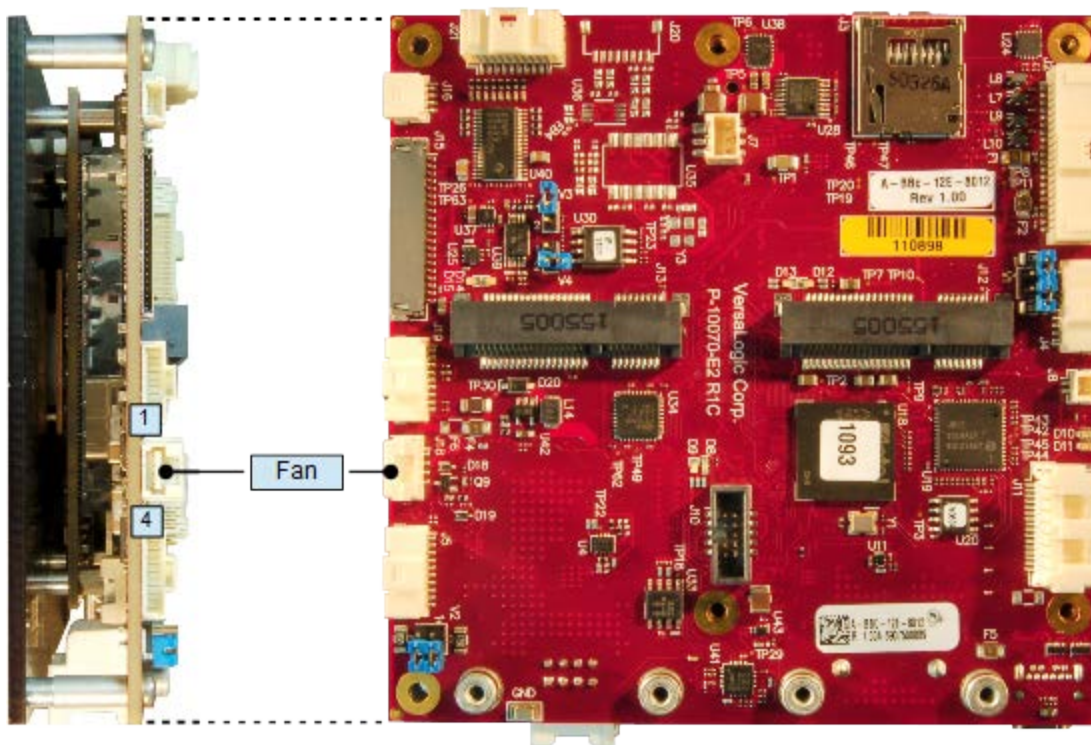

EPU3312_38

Figure 11. Location and Pin Orientation of the CPU Fan Connector

Table 6 provides the pinout of the CPU fan connector.

Table 6: CPU Fan Connector Pinout

Pin	Signal
1	Ground
2	+12 VDC (Note)
3	FAN_TACH
4	FAN_CONTROL

Note: The maximum current is 0.175 A

Cabling

If your application requires a custom cable, the following information will be useful:

EPU-3312 Board Connector	Mating Connector
Molex 502386-0470	Molex 502380-0400

LEDs

Figure 12 shows the locations of the status indicator LEDs

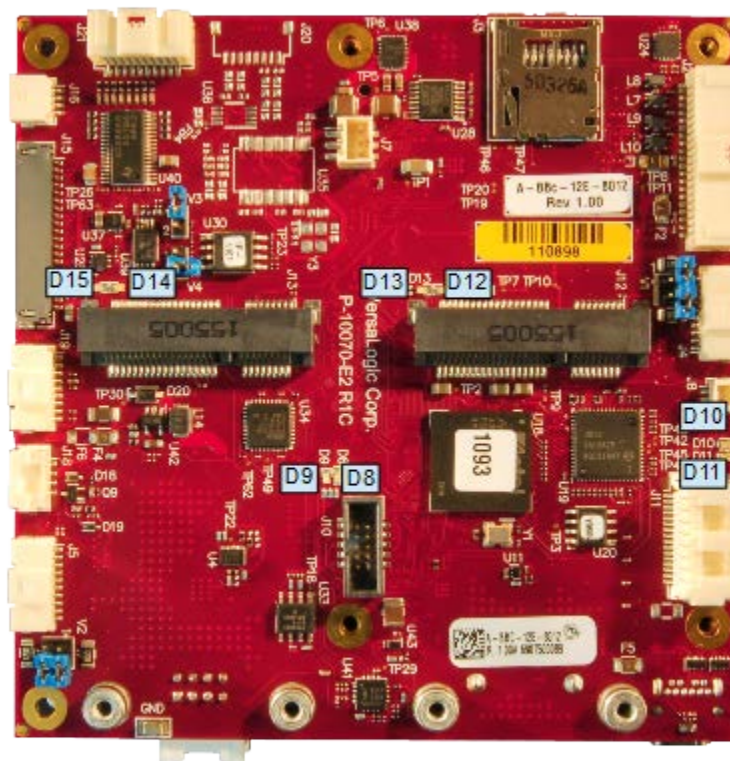

EP-U3312_23

LED	Status Indication	Reference
D8	SATA/mSATA (blue) activity	Figure 19, page 36
D9	Power good (green) and fault indicator (yellow) dual-LED	Figure 13, page 28
D10	Link activity (green) for Ethernet port 0	Figure 28, page 54
D11	Link activity (green) for Ethernet port 1	Figure 28, page 54
D12	Wireless WAN/LAN activity for module installed in Mini PCIe Socket #1 (Dual-LED)	Table 8, page 35
D13	Status of power and wireless PAN activity for module installed in Mini PCIe Socket #1 (Dual-LED)	Table 8, page 35
D14	Wireless WAN/LAN activity for module installed in Mini PCIe Socket #2 (Dual-LED)	Table 8, page 35
D15	Status of power and wireless PAN activity for module installed in Mini PCIe Socket #2 (Dual-LED)	Table 8, page 35

Figure 12. Location of Status Indicator LEDs

Power-Good/Fault Indicator LEDs

A dual-color (green/yellow) LED provides the following status:

- Green – indicates power good when the Raven in an S0 state. When in sleep modes, the LED pulses every 2 seconds.
- Yellow – indicates a fault. If this LED remains lit after power-cycling the Raven, contact VersaLogic Customer Support.

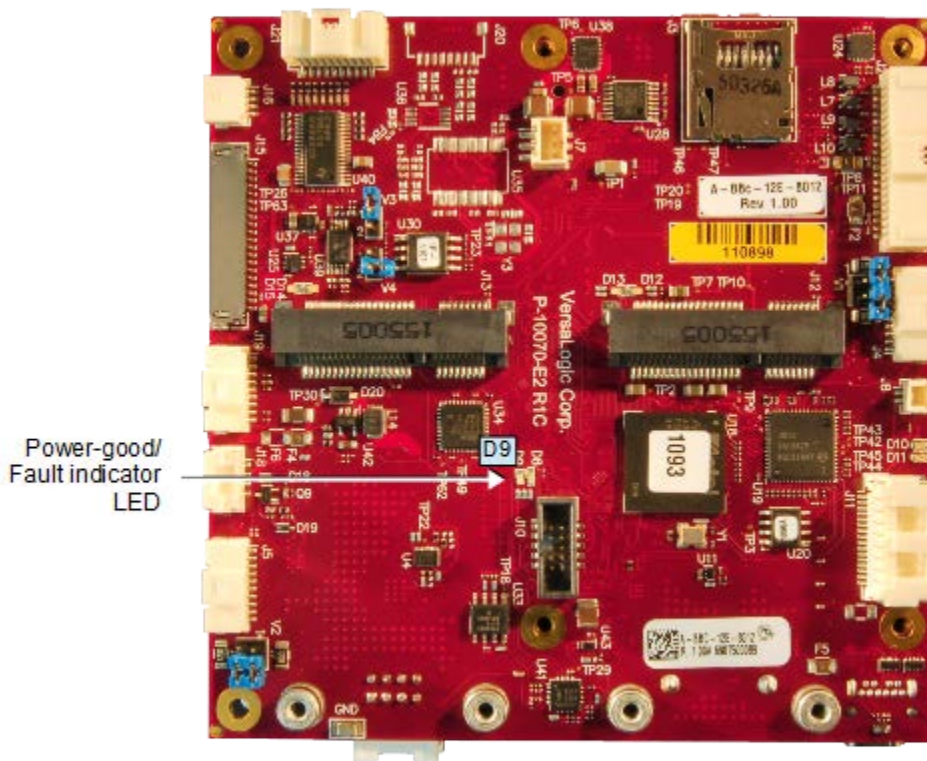

EP U3312_24

Figure 13. Location of the Power-good/Fault Indicator LED

Mass Storage Interfaces

SATA Interface

The Raven provides one serial ATA (SATA) port that communicates at a rate of up to 3.0 Gbits/s (SATA II). The SATA connector is a SATA II-compatible right-angle connector with latching capability. The ATX power supplies Power to the SATA drive. Note that the standard SATA drive power connector is different from the common 4-pin Molex connector used on IDE drives. Most current ATX power supplies provide SATA connectors, and many SATA drives provide both types of power connectors. If the power supply you are using does not provide SATA connectors, adapters are available.

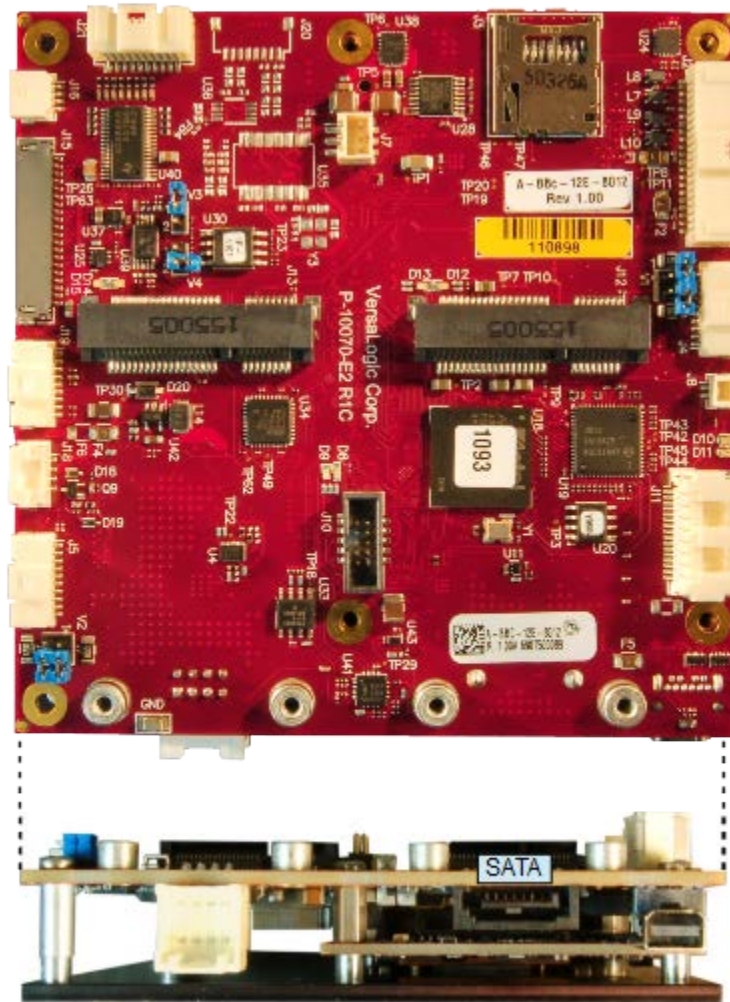

EP U3312_09

Figure 14. Location of the SATA Connector

microSD Socket

The Raven provides a microSD socket on the top side of the baseboard. The VL-F41 series of microSD cards provide solid-state storage of 2 GB, 4 GB, or 8 GB. The microSD socket accommodates cards with up to 32 GB of storage capacity.

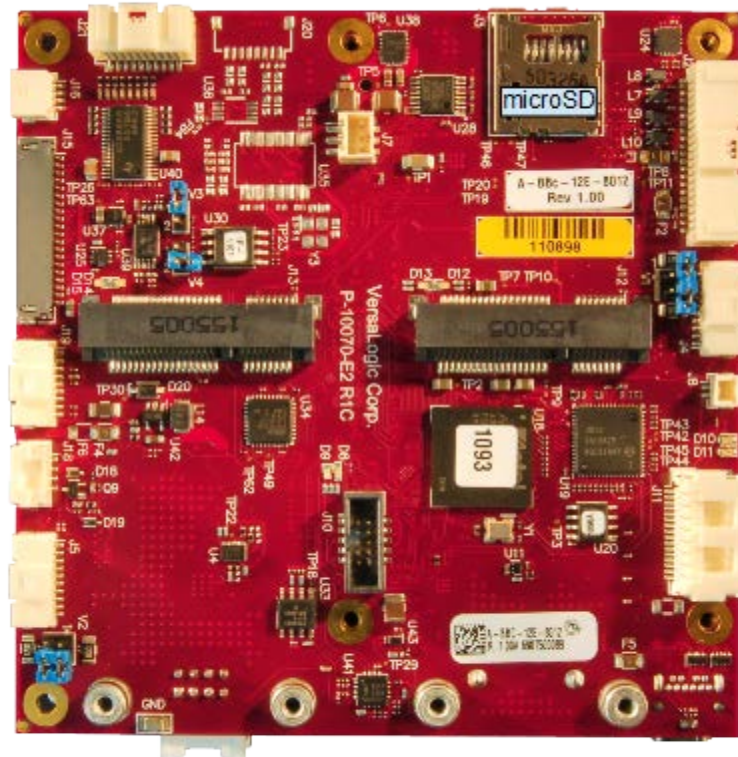

EP US312_10

Figure 15. Location of the microSD Socket

eMMC Flash

The Raven provides on-board eMMC Flash storage on certain models of the product. Specifically:

- VL-EPU-3312-EAP: none
- VL-EPU-3312-EBP: 4 GB
- VL-EPU-3312-EDP: 8 GB

Multi-purpose I/O

USB Interfaces

As shown in Figure 16, the Raven provides access to six USB ports.

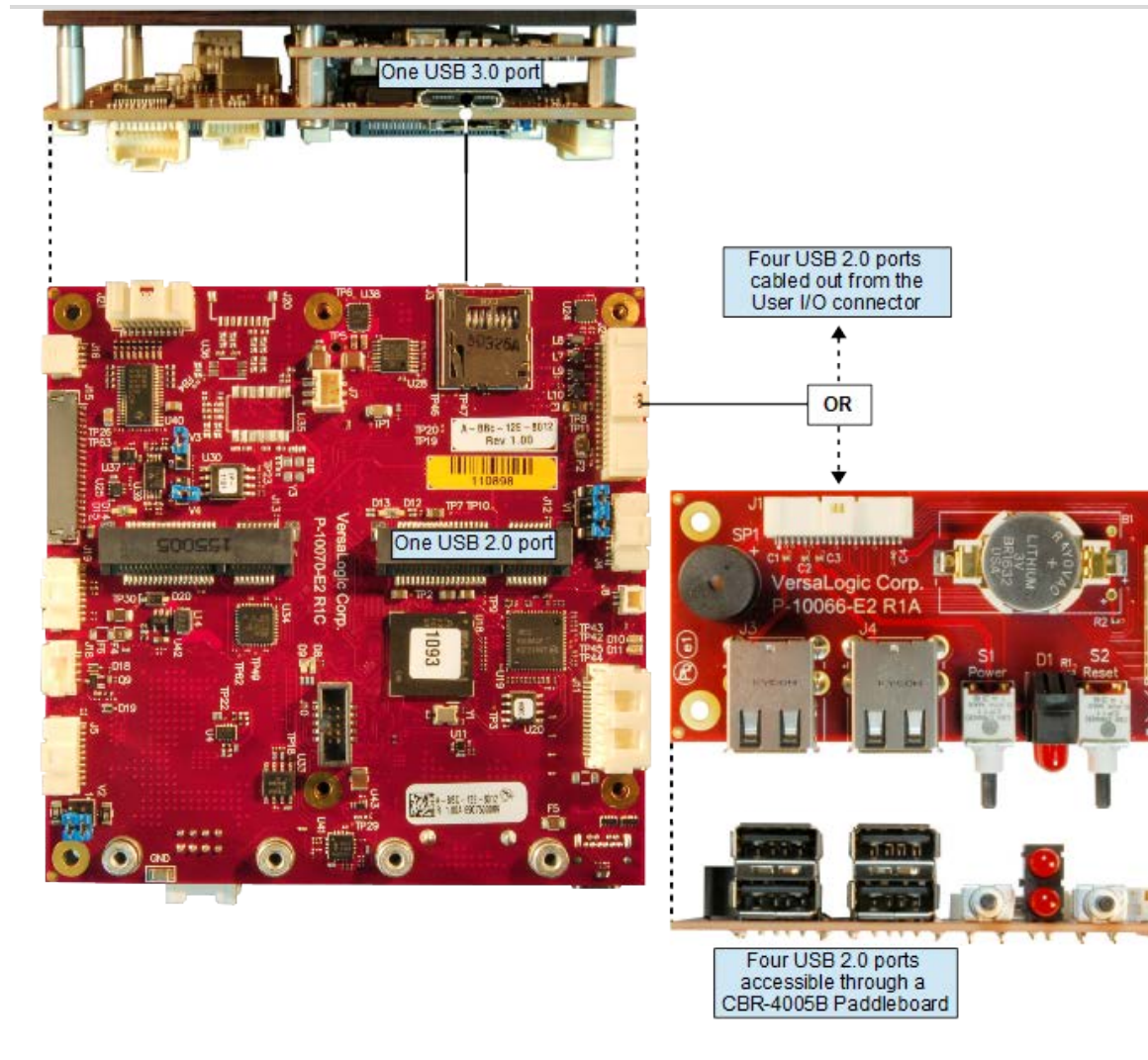

Figure 16. Location of the USB Ports

Warning! The micro USB 3.0 connector can be damaged (that is, detached from the board) if an inserted USB cable is removed by pulling up and away from the board. To reduce the risk of damaging the connector (and the board), pull the cable straight out of the connector; also, do not rock or wiggle the cable back and forth to loosen it from the connector.

Mini PCIe Sockets

Figure 17 shows the location of the two Mini PCIe sockets. Mini PCIe Socket #1 supports the use of an mSATA card.

Each Mini PCIe interface includes one PCIe x1 lane, one USB 2.0 channel, and the SMBus interface. The sockets are compatible with plug-in Wi-Fi modems, GPS receivers, MIL-STD-1553, flash data storage, and other cards for added flexibility. For information on Mini PCIe modules available from VersaLogic, contact Sales@VersaLogic.com.

The VL-MPEs-F1E series of mSATA modules provide flash storage of 4 GB, 16 GB, or 32 GB.

To secure a Mini PCIe card or mSATA module to the on-board standoffs, use two M2.5 x 6 mm pan head Philips nylon screws. These screws are available in quantities of 10 in the VL-HDW-108 hardware kit from VersaLogic.



Integrator's Note:

- Mini PCIe Socket #1 supports the use of an mSATA card; Socket #2 does not.

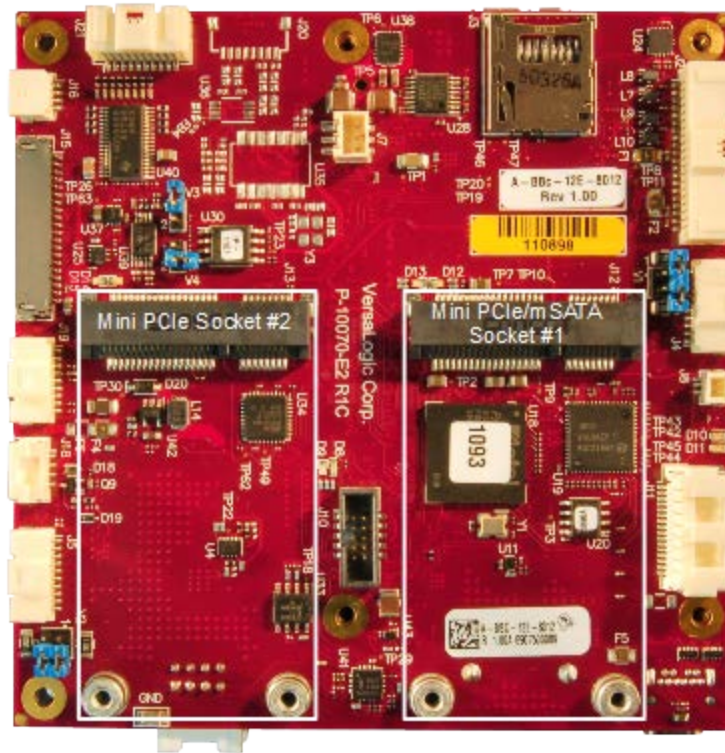

EP U3312_11

Figure 17. Location of Mini PCIe Sockets

Table 7: Mini PCIe / mSATA Socket Pinout

Pin	Mini PCIe Signal Name	Mini PCIe Function	mSATA Signal Name	mSATA Function
1	WAKE#	Wake	Reserved	Not connected
2	3.3VAUX	3.3 V auxiliary source	+3.3V	3.3 V source
3	NC	Not connected	Reserved	Not connected
4	GND	Ground	GND	Ground
5	NC	Not connected	Reserved	Not connected
6	1.5V	1.5 V power	+1.5V	1.5 V power
7	CLKREQ#	Reference clock request	Reserved	Not connected
8	NC	Not connected	Reserved	Not connected
9	GND	Ground	GND	Ground
10	NC	Not connected	Reserved	Not connected
11	REFCLK-	Reference clock input -	Reserved	Not connected
12	NC	Not connected	Reserved	Not connected
13	REFCLK+	Reference clock input +	Reserved	Not connected
14	NC	Not connected	Reserved	Not connected
15	GND	Ground	GND	Ground
16	NC	Not connected	Reserved	Not connected
17	NC	Not connected	Reserved	Not connected
18	GND	Ground	GND	Ground
19	NC	Not connected	Reserved	Not connected
20	W_DISABLE#	Wireless disable	Reserved	Not connected
21	GND	Ground	GND	Ground
22	PERST#	Card reset	Reserved	Not connected
23	PERn0	PCIe receive -	+B	Host receiver diff. pair +
24	3.3VAUX	3.3 V auxiliary source	+3.3V	3.3 V source
25	PERp0	PCIe receive +	-B	Host receiver diff. pair -
26	GND	Ground	GND	Ground
27	GND	Ground	GND	Ground
28	1.5V	1.5 V power	+1.5V	1.5 V power
29	GND	Ground	GND	Ground
30	SMB_CLK	SMBus clock	Two Wire I/F	Two wire I/F clock
31	PETn0	PCIe transmit -	-A	Host transmitter diff. pair -
32	SMB_DATA	SMBus data	Two Wire I/F	Two wire I/F data
33	PETp0	PCIe transmit +	+A	Host transmitter diff. pair +
34	GND	Ground	GND	Ground
35	GND	Ground	GND	Ground
36	USB_D-	USB data -	Reserved	Not connected

Pin	Mini PCIe Signal Name	Mini PCIe Function
37	GND	Ground
38	USB_D+	USB data +
39	3.3VAUX	3.3V auxiliary source
40	GND	Ground
41	3.3VAUX	3.3 V auxiliary source
42	LED_WWAN #	Wireless WAN LED
43	GND	mSATA Detect (Note 1)
44	LED_WLAN#	Wireless LAN LED
45	NC	Not connected
46	LED_WPAN#	Wireless PAN LED
47	NC	Not connected
48	1.5V	1.5 V power
49	Reserved	Reserved
50	GND	Ground
51	Reserved	Reserved
52	3.3VAUX	3.3 V auxiliary source

mSATA Signal Name	mSATA Function
GND	Ground
Reserved	Not connected
+3.3V	3.3 V source
GND	Ground
+3.3V	3.3 V source
Reserved	Not connected
GND/NC	Ground/Not connected (Note 2)
Reserved	Not connected
Vendor	Not connected
Reserved	Not connected
Vendor	Not connected
+1.5V	1.5 V power
DA/DSS	Device activity (Note 3)
GND	Ground
GND	Ground (Note 4)
+3.3V	3.3 V source

Notes:

1. This pin is not grounded on the Raven since it can be used to detect the presence of an mSATA module versus a Mini PCIe card.
2. This pin is not grounded on the Raven to make it available for mSATA module detection.
3. This signal drives the blue LED activity indicator shown in Figure 19. This LED lights with mSATA disk activity (if supported by the mSATA module).
4. Some Mini PCIe cards use this signal as a second Mini PCIe card wireless disable input. On the Raven, this signal is available for use for mSATA versus Mini PCIe card detection. There is an option on the VersaLogic Features BIOS Setup utility screen for setting the mSATA detection method.

W_DISABLE# Signal

The W_DISABLE# signal is for use with optional wireless Ethernet Mini PCIe cards. The signal enables you to disable a wireless card's radio operation in order to meet public safety regulations or when otherwise desired. W_DISABLE# is an active low signal that when driven low (shorted to ground) disables radio operation on the Mini PCIe card wireless device. When W_DISABLE# is not asserted, or in a high impedance state, the radio may transmit if not disabled by other means such as software. The W_DISABLE# signals for each of the two Minicards are controlled by registers in the FPGA.

Mini PCIe Card Wireless Status LEDs

Dual-colored (green and yellow) LEDs provide status for modules installed in the Mini PCIe sockets. These LEDs light when the associated device is installed and capable of transmitting. Table 8 lists the states of the LEDs. Figure 18 shows their location on the Raven.

Table 8: Mini PCIe Card Wireless Status LEDs

LED	Color	State	Description
D12 and D14	Green	On ■	Wireless WAN active
		Off ▢	Wireless WAN inactive
	Yellow	On ■	Wireless LAN active
		Off ▢	Wireless LAN inactive
D13 and D15	Green	On ■	Wireless PAN active
		Off ▢	Wireless PAN inactive
	Yellow	On ■	Minicard power is ON
		Off ▢	Minicard power is OFF

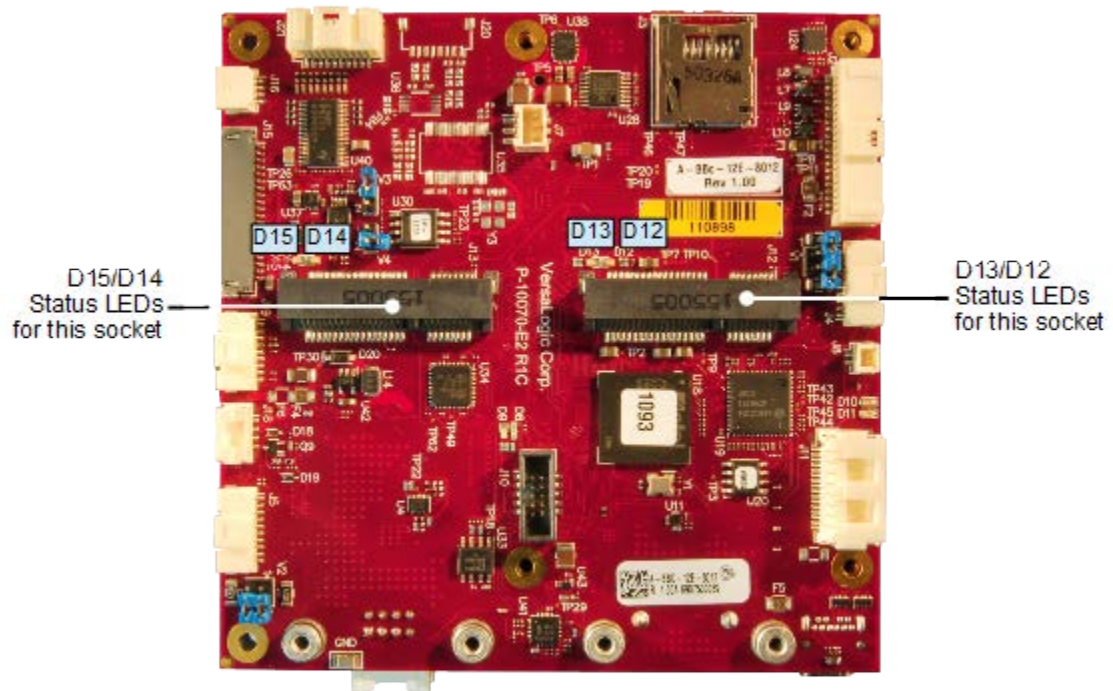

EP L3312_07

Figure 18. Mini PCIe Wireless Status LEDs

mSATA Activity LED

Figure 19 shows the location of the SATA/mSATA activity blue LED. This LED indicates activity on either the SATA or the mSATA interface. Not all mSATA drives provide this disk activity signal.

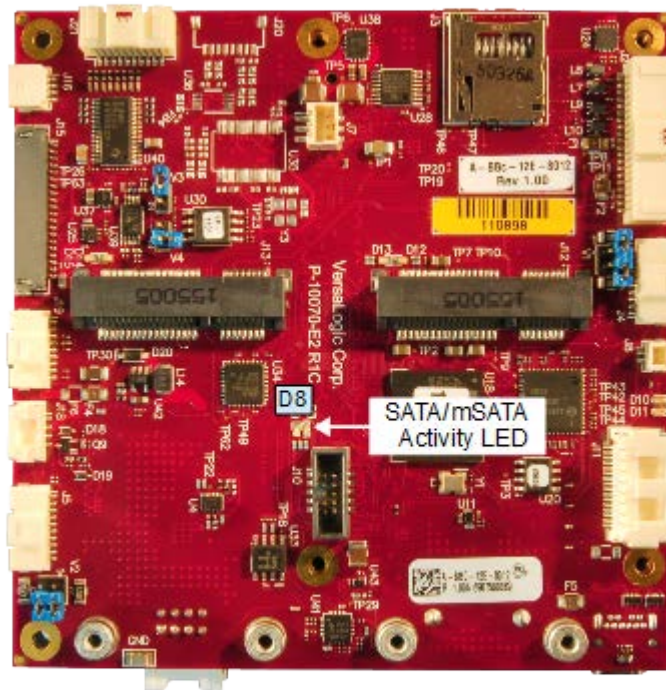

EPU3312_20

Figure 19. Location of the SATA/mSATA Activity LED

User I/O Connector

The 40-pin user I/O connector incorporates the signals for the following:

- Four USB ports
- Eight GPIO lines (these are functionally muxed with six timer I/O signals per FPGA registers). There are eight timer signals and they share digital I/Os 16-9. The eight GPIO lines on the paddleboard each have an alternate mode, accessible using the FPGA's AUXMOD1 register. Refer to the *EPU-3312 Programmer's Reference Manual* for more information on FPGA registers.
- Three LEDs (two Ethernet link status LEDs and a programmable LED)
- Two I²C signals (clock and data)
- Push-button power switch
- Push-button reset switch
- Speaker output

This connector uses IEC 61000-4-2-rated TVS components to help protect against ESD damage.

Figure 20 shows the location and pin orientation of the user I/O connector.

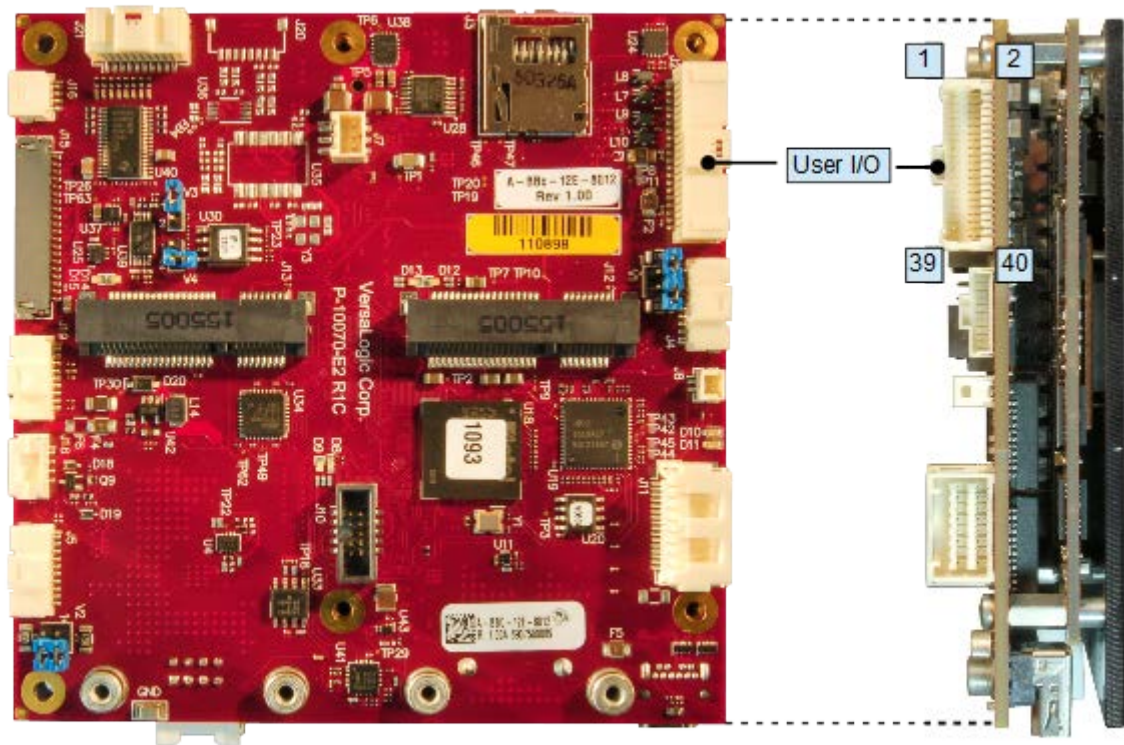

EPU3312_14

Figure 20. Location and Pin Orientation of the User I/O Connector

Table 9 provides the pinout of the user I/O connector.

Table 9: User I/O Connector Pinout and Pin Orientation

Pin	Signal	Pin	Signal
1	+5 V (Note 1)	2	GND
3	USB1_P	4	USB2_P
5	USB1_N	6	USB2_N
7	+5V (Note 2)	8	GND
9	USB3_P	10	USB4_P
11	USB3_N	12	USB4_N
13	+3.3 V (Note 3)	14	GND
15	SPKR#	16	PLED#
17	PWR_BTN#	18	RST_BTN#
19	GND	20	GND
21	I2C Clock	22	V_BATT
23	I2C Data	24	V_BATT Return
25	GND	26	GND
27	GPIO1	28	GPIO2
29	GPIO3	30	GPIO4
31	GND	32	GND
33	GPIO5	34	GPIO6
35	GPIO7	36	GPIO8
37	+3.3 V (Note 4)	38	GND
39	ETH0 LED	40	ETH1 LED

Notes:

1. This is the +5V VBUS power for USB Port 1 and 2.
2. This is the +5V VBUS power for USB Port 3 and 4.
3. This 3.3 V power goes off in sleep modes. The SPKR# uses this power as should the PLED# (there is no requirement for PLED# to use this power, but the VL-CBR-4005B paddleboard does).
4. This 3.3 V power can be turned on or off similar to the 3.3V power to the Mini Card via the FPGA (can go off in sleep modes or always stay on; by default it goes off in sleep modes). It is used for the 10 k Ω pullup resistor power on the 8x GPIOs and usually for the 2x Ethernet LEDs, however, the Ethernet LEDs can be powered by a 3.3 V power source.

Cabling

An adapter cable, part number VL-CBR-4005A, is available for connecting the CBR-4005B paddleboard to the VL-EPU-3312. This is a 12-inch, Pico-Clasp 40-pin to 40-pin cable.

If your application requires a custom cable, the following information will be useful:

EPU-3312 Board Connector	Mating Connector
Molex 501571-4007	Molex 501189-4010

Analog-to-Digital Converter Interface

The Analog-to-Digital converter interface provides eight single-ended analog input channels. Figure 21 shows the location and pin orientation of the Analog-to-Digital input connector.

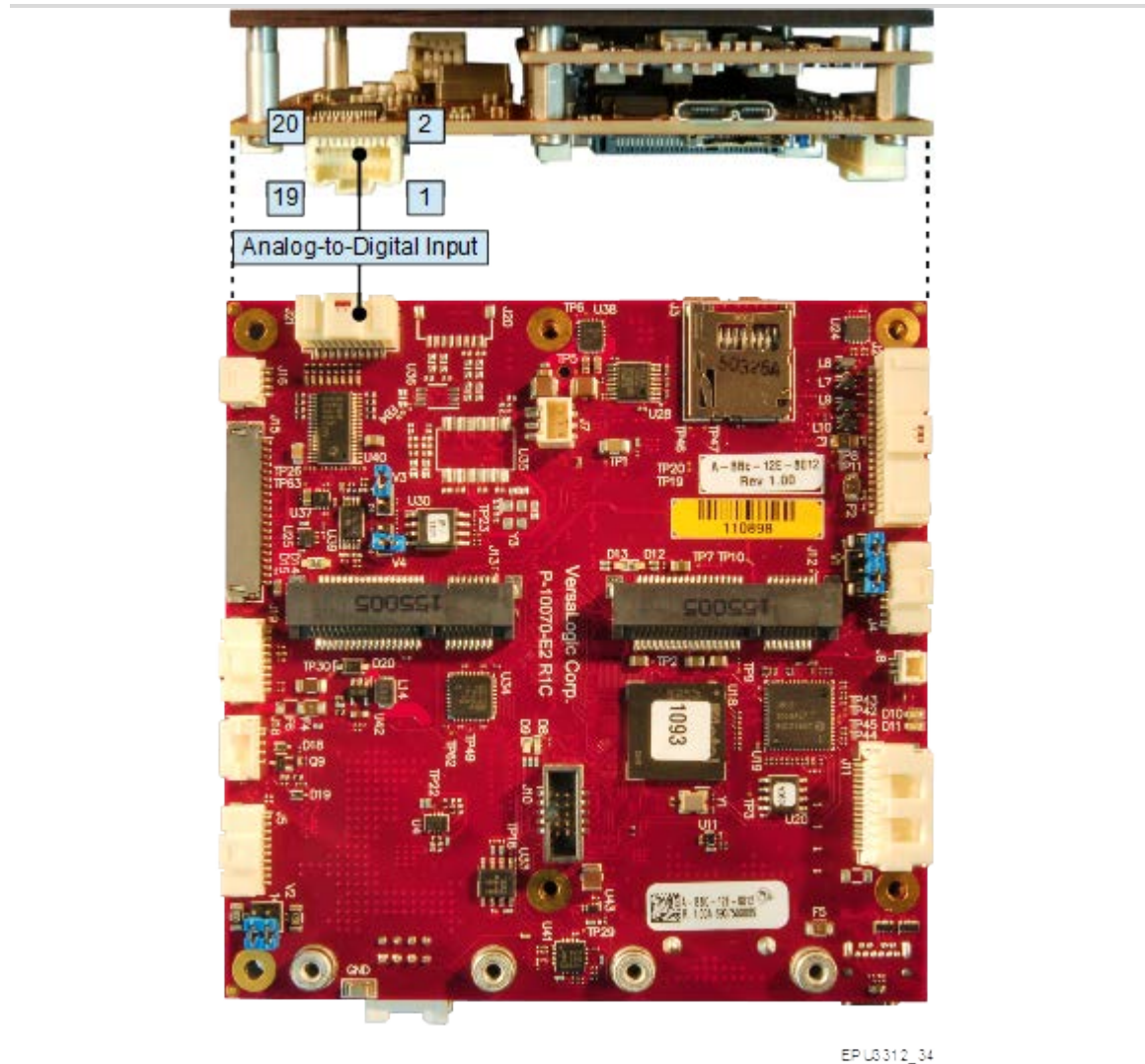

Figure 21. Location and Pin Orientation of the Analog-to-Digital Input Connector

The EPU-3312 uses a Texas Instruments ADS8668 eight-channel 12-bit A/D converter. The converter has a 500 kilo-samples-per-second (ksps) aggregate sampling rate, with a 1.115 μ s acquisition time, high-impedance. The converter is per-channel programmable for the following input ranges:

- ± 0.64 V
- ± 1.28 V
- ± 2.56 V
- ± 5.12 V
- ± 10.24 V
- 0 to 1.28 V
- 0 to 2.56 V
- 0 to 5.12 V
- 0 to 10.24 V

Communications with the A/D converter are handled by the FPGA, which uses the SPX slave selection signal for SPI device 5 to enable the A/D read strobe for the SPI interface. Refer to the *VL-EPU-3312 Programmer's Reference Manual* (available on the EPU-3312 Product Support Web Page) for information on configuring the SPX registers for A/D access.

Refer to the [Texas Instruments ADS8668 A/D Converter Datasheet](#) for programming information.

Table 10 provides the pinout of the Analog-to-Digital Input connector.

Table 10: Analog-to-Digital Input Connector Pinout

Pin	Signal	Pin	Signal
1	Analog Input 1	2	Analog Input 2
3	Analog Ground	4	Analog Ground
5	Analog Input 3	6	Analog Input 4
7	Analog Ground	8	Analog Ground
9	Analog Input 5	10	Analog Input 6
11	Analog Ground	12	Analog Ground
13	Analog Input 7	14	Analog Input 8
15	Analog Ground	16	Analog Ground
17	Digital Ground	18	Digital Ground
19	Reserved	20	Reserved

Cabling

The VL-CBR-2004 paddleboard is bundled with an adapter cable for connecting the Raven to the VL-CBR-2004 paddleboard. This is a 12-inch, Pico-Clasp 20-pin to 20-pin cable.

If your application requires a custom cable, the following information will be useful:

EPU-3312 Board Connector	Mating Connector
Molex 501571-2007	Molex 501189-2010

SPX* Expansion Bus

Up to two serial peripheral expansion (SPX) devices can be attached to the Raven at connector using a CBR-0901 cable. The SPX interface provides the standard serial peripheral interface (SPI) signals: CLK, MISO, and MOSI, as well as two chip selects, SS0# and SS1#. The +5 V power provided to pin 1 of the SPX connector is protected by a 1 A resettable fuse.

Figure 22 shows the location and pin orientation of the SPX connector.

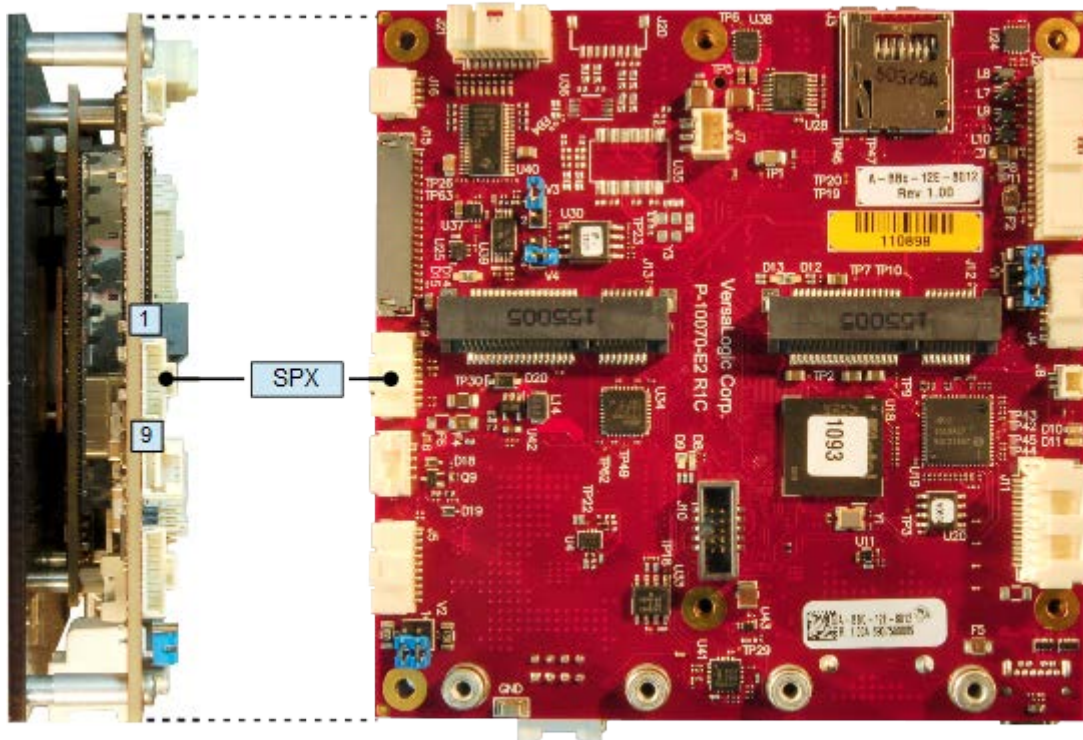

EP U3312_37

Figure 22. SPX Connector Location and Pin Configuration

Table 11 lists the pinout of the SPX connector.

Table 11: SPX Connector Pinout

Pin	Signal	Function
1	V5_SPX	+5.0 V
2	CLK	SPX Clock
3	GND	Ground
4	MISO	Master input, Slave output
5	GND	Ground
6	MOSI	Master output, Slave input
7	GND	Ground
8	SS0#	Chip Select 0
9	SS1#	Chip Select 1

SPI is, in its simplest form, a three wire serial bus. One signal is a clock, driven only by the permanent master device on-board. The others are Data In and Data Out with respect to the master. The SPX implementation on the Raven supports chip selects. The master device initiates all SPI transactions. A slave device responds when its chip select is asserted and it receives clock pulses from the master. All four common SPI modes are supported through the use of clock polarity and clock idle state controls.

The SPI clock is derived from a 33 MHz PCI clock and can be software-configured to operate at the following frequencies:

- 8.25 MHz (33 MHz/4)
- 4.125 MHz (33 MHz/8)
- 2.0625 MHz (33 MHz/16)
- 1.03125 MHz (33 MHz/32)

Cabling

An adapter cable, part number CBR-0901, is available. This is a 9-inch, 9-pin Pico-Clasp to Dual SPX cable.

If your application requires a custom cable, the following information will be useful:

EPM-31 Board Connector	Mating Connector
Molex 501568-0907	Molex 501330-0900

Serial Ports

The Raven provides four serial ports. All ports can be operated in RS-232, RS-422, or RS-485 mode. IRQ lines are chosen in the BIOS Setup utility. The UARTs are 16550-based serial ports and are implemented in the FPGA.

Figure 23 shows the location and pin orientation of the two serial I/O connectors.

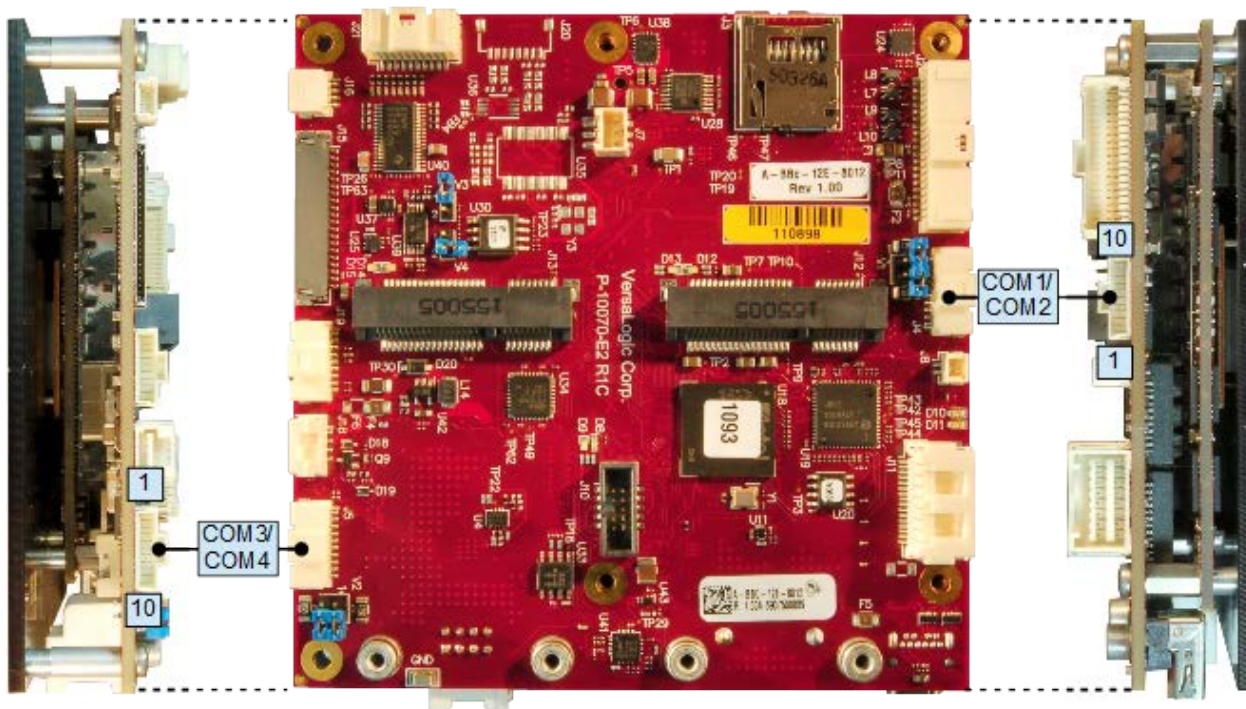

EP U312_15

Figure 23. Location and Pin Orientation of the Serial I/O Connectors

Serial Port Connector Pinout

Table 12: COM1/COM2 Connector Pinout

Pin	RS-232 Signal	RS-422/RS-485 Signal	Port
1	RTS1	TXD1_P	COM1
2	TXD1#	TXD1_N	
3	CTS1	RXD1_P	
4	RXD1#	RXD1_N	
5	GND	GND	—
6	RTS2	TXD2_P	COM2
7	TXD2#	TXD2_N	
8	CTS2	RXD2_P	
9	RXD2#	RXD2_N	
10	GND	GND	—

Table 13: COM3/COM4 Connector Pinout

Pin	RS-232 Signal	RS-422/RS-485 Signal	Port
1	RTS3	TXD3_P	COM3
2	TXD3#	TXD3_N	
3	CTS3	RXD3_P	
4	RXD3#	RXD3_N	
5	GND	GND	—
6	RTS4	TXD4_P	COM4
7	TXD4	TXD4_N	
8	CTS4	RXD4_P	
9	RXD4#	RXD4_N	
10	GND	GND	—

Cabling

An adapter cable, part number CBR-1014, is available for routing the serial I/O signals to 9-pin D-sub connectors. This is a 12-inch, Pico-Clasp 10-pin to two 9-pin D-sub connector cable.

If your application requires a custom cable, the following information will be useful:

EPU-3312 Board Connector	Mating Connector
Molex 501331-1007	Molex 501330-1000

COM Port Configuration

Jumper blocks V1 and V2 configure the serial ports for RS-232 or RS-485/RS-422 operation. See the section titled “Jumper Blocks” on page 17 for details. The termination resistor should only be enabled for RS-485 or RS-422 endpoint stations and not for intermediate stations. Termination must not be used for RS-232.

Console Redirection

The Raven can be configured for remote access by redirecting the console to a serial communications port. The BIOS Setup utility and some operating systems (such as MS-DOS) can use this console for user interaction. The default settings for the redirected console are as follows:

- 115,200 baud rate
- 8 data bits, No parity, 1 stop bit (that is, 8-None-1)
- No flow control

Video Interfaces

7

The Intel Atom E38xx processor series contains an integrated graphics engine with advanced 2D/3D graphics, video decode and encode capabilities, and a display controller. The Raven provides the following video interfaces:

- One Mini DisplayPort++ connector
- One LVDS display connector; a 4-pin LVDS backlight connector is also provided

Mini DisplayPort++ Connector

DisplayPort consists of three interfaces:

- Main Link – transfers high-speed isochronous video and audio data
- Auxiliary channel – used for link management and device control; the EDID is read over this interface
- Hot Plug Detect – indicates that a cable is plugged in

The DisplayPort interface supports:

- Audio signaling
- DP++ mode allowing connection to an HDMI device through a passive adapter. “Passive” means that the adapter does not require external power (because it uses the DP port’s 3.3 V power) and it does not require software drivers.

Figure 24 shows the location of the 20-pin Mini DisplayPort++connector. Table 14 lists the pinout of the Mini DisplayPort++ connector.

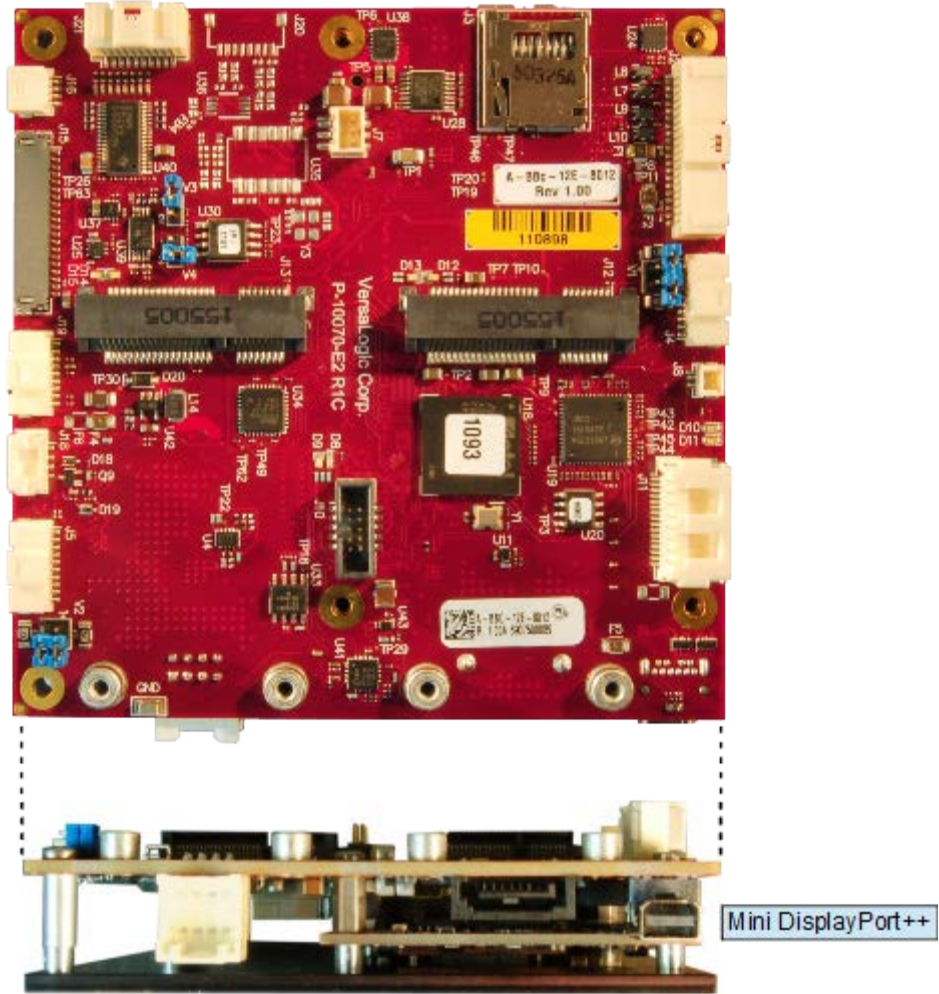

EPU3312_18

Figure 24. Location of the Mini DisplayPort++ Connector

Table 14: Mini DisplayPort++ Connector Pinout

Pin	Signal	Pin	Signal
1	GND	2	HOT PLUG DETECT
3	ML_LANE0_P	4	CONFIG 1
5	ML_LANE0_N	6	CONFIG 2
7	GND	8	GND
9	ML_LANE1_P	10	ML_LANE3_P
11	ML_LANE1_N	12	ML_LANE3_N
13	GND	14	GND
15	ML_LANE2_P	16	AUX_CH_P
17	ML_LANE2_N	18	AUX_CH_N
19	GND	20	DP_POWER (3.3V)

VGA Output

A VGA monitor can be attached to the Mini DisplayPort++ connector using the VL-CBR-2032 Mini DisplayPort-to-VGA adapter, similar to the one shown in Figure 25.



Figure 25. VL-CBR-2032 Mini DisplayPort to VGA Adapter

Mini DisplayPort Cable Options

There is a 36 inch Mini DisplayPort to Mini DisplayPort cabling option available. (VL-CBR-2031) There is also a Mini DisplayPort to HDMI 6 inch cable available (VL-CBR-2033). There is a Mini DisplayPort to VGA cable kit as well. (VL-CBR-2032)

LVDS Interface

LVDS Flat Panel Display Connector

The integrated LVDS flat panel display in the Raven is an ANSI/TIA/EIA-644-1995 specification-compliant interface. It can support 18 or 24 bits of RGB pixel data plus 3 bits of timing control (HSYNC/VSYNC/DE) on the 4 differential data output pairs. The LVDS interface supports a maximum resolution of 1280 x 768 (60 Hz). Figure 26 shows the location of the LVDS display connector as well as the location and pin orientation of the LVDS back light connector.

The BIOS Setup utility provides several options for standard LVDS flat panel types. If these options do not match the requirements of the panel you are using, contact Support@VersaLogic.com for a custom video BIOS.

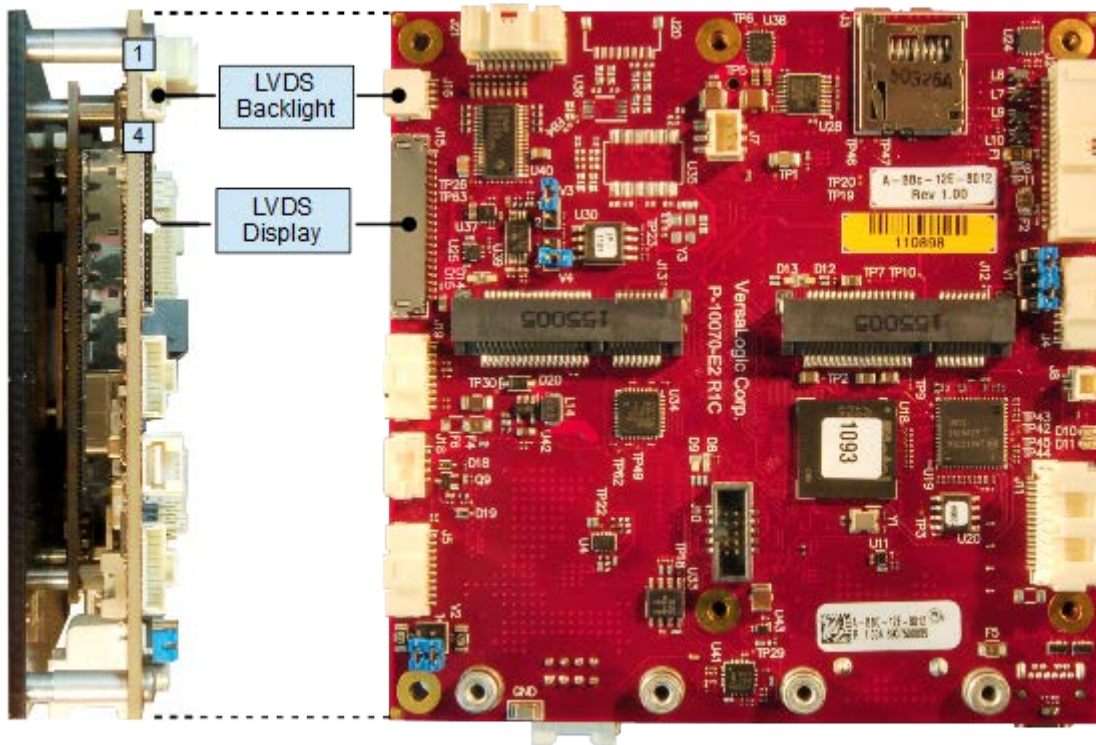

EP-U3312_17

Figure 26. Location of the LVDS Connectors

Table 15: LVDS Flat Panel Display Connector Pinout

Pin	Signal Name	Function
1	GND	Ground
2	NC	Not Connected
3	LVDSA3	Differential Data 3 (+)
4	LVDSA3#	Differential Data 3 (-)
5	GND	Ground
6	LVDSCLK0	Differential Clock (+)
7	LVDSCLK0#	Differential Clock (-)
8	GND	Ground
9	LVDSA2	Differential Data 2 (+)
10	LVDSA2#	Differential Data 2 (-)
11	GND	Ground
12	LVDSA1	Differential Data 1 (+)
13	LVDSA1#	Differential Data 1 (-)
14	GND	Ground
15	LVDSA0	Differential Data 0 (+)
16	LVDSA0#	Differential Data 0 (-)
17	GND	Ground
18	GND	Ground
19	+3.3V	+3.3 V (Protected)
20	+3.3V	+3.3 V (Protected)

The +3.3V power provided to pins 19 and 20 is protected by a software-controllable power switch (1 Amp max.). The LVDD_EN signal controls this switch from the LVDS interface controller in the CPU.

Cabling

The following LVDS cables are available for use with the Raven board:

- VL-CBR-2015 – a 20-inch 24-bit LVDS 1mm Hirose* cable
- VL-CBR-2016 – a 20-inch 18-bit LVDS flat-panel display cable with a JAE connector
- VL-CBR-2017 – a 20-inch 24-bit 1.25 mm Hirose cable

If your application requires a custom cable, the following information will be useful:

EPU-3312 Board Connector	Mating Connector
Hirose DF19G-20P-1H(54)	<ul style="list-style-type: none"> • Hirose DF19G-20S-1C (housing) • Hirose DF19-2830SCFA x19 (crimp socket)

LVDS Backlight Connector

Figure 236 on page 49 shows the location and pin orientation of the LVDS back light connector. Table 16 lists the pinout of the LVDS backlight connector.

Table 16: LVDS Backlight Connector Pinout

Pin	Signal Name	Function
1	LVDS_BKLT_EN	LVDS backlight enable. (5V TTL-level signal by default but will operate at higher voltages if the LVDS_BKLT_PWR is provided). High = enabled, Low = disabled.
2	Signal Ground	Ground
3	LVDS_BKLT_CTRL	LVDS backlight control. (5V TTL-level signal by default but will operate at higher voltages if the LVDS_BKLT_PWR is provided). This is a PWM signal and the duty cycle can be set in the BIOS Setup utility.
4	LVDS_BKLT_LOGIC_PWR	Optional backlight logic power. (Can range from +5V to +14V and sets the high-value on the LVDS_BKLT_EN and LVDS_BKLT_CTRL signals.) On-board +5V power is used when this is not connected.

Cabling

An adapter cable, part number CBR-0404, is available for powering the LVDS backlight from the Raven board.

If your application requires a custom cable, the following information will be useful:

EPU-3312 Board Connector	Mating Connector
Molex 501568-0407	Molex 501330-0400

Network Interfaces

8

The Raven provides two Intel I210-IT Gigabit Ethernet controllers. The controller provides a standard IEEE 802.3 Ethernet interface for 1000Base-T, 100Base-TX, and 10Base-T applications. The I210-IT Ethernet controller auto-negotiates connection speed. Drivers are readily available to support a variety of operating systems. For more information on this device, refer to the [Intel I210 Ethernet Controller datasheet](#).

⚠ Integrator's Note: Ethernet Port 1 supports network boot; Port 0 does not.

Ethernet Connector

The Ethernet connector provides access to the Ethernet ports 0 and 1. The connector uses IEC 61000-4-2-rated TVS components to help protect against ESD damage. Figure 27 shows the location and pin orientation of the Ethernet connector.

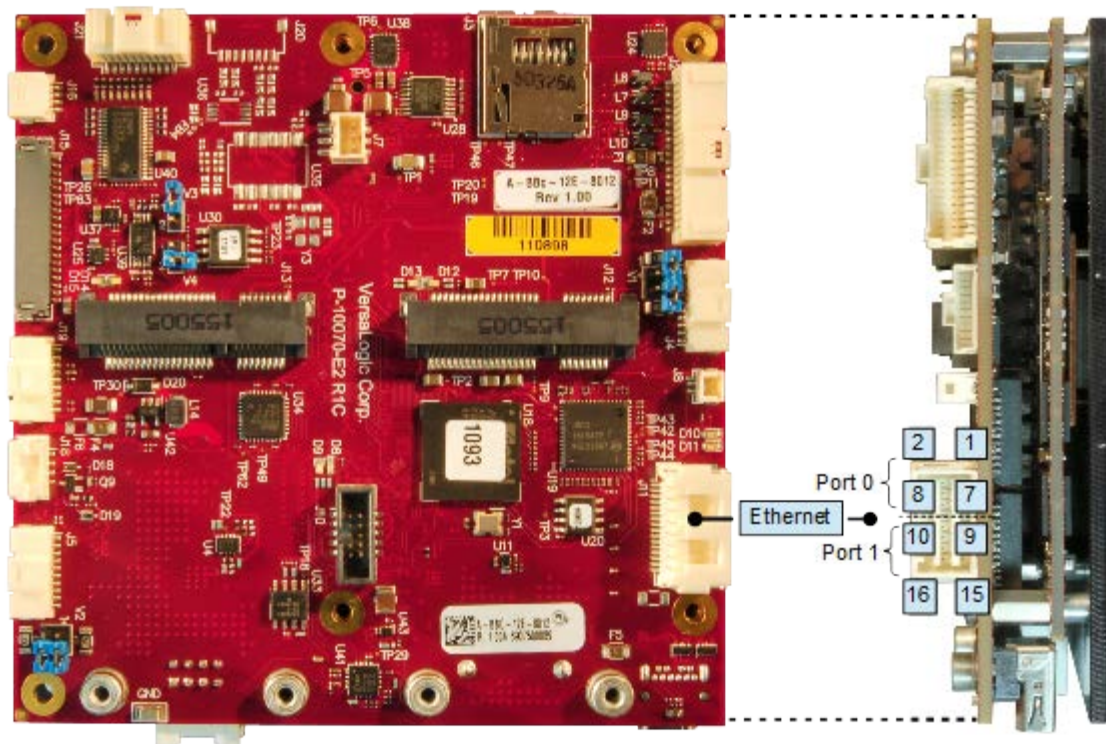

EP_L0312_16

Figure 27. Location and Pin Orientation of the Ethernet Connector

Table 17 lists the pinout of the Ethernet connector.

Table 17: Ethernet Connector Pinout

	Pin	10/100 Signals	10/100/1000 Signals		Pin	10/100 Signals	10/100/1000 Signals	
Port 0	1	- Auto Switch (Tx or Rx)	BI_DD-	Port 0	2	+ Auto Switch (Tx or Rx)	BI_DD+	Port 0
	3	- Auto Switch (Tx or Rx)	BI_DB-		4	+ Auto Switch (Tx or Rx)	BI_DB+	
	5	- Auto Switch (Tx or Rx)	BI_DC-		6	+ Auto Switch (Tx or Rx)	BI_DC+	
	7	- Auto Switch (Tx or Rx)	BI_DA-		8	+ Auto Switch (Tx or Rx)	BI_DA+	
Port 1	9	- Auto Switch (Tx or Rx)	BI_DD-	Port 1	10	+ Auto Switch (Tx or Rx)	BI_DD+	Port 1
	11	- Auto Switch (Tx or Rx)	BI_DB-		12	+ Auto Switch (Tx or Rx)	BI_DB+	
	13	- Auto Switch (Tx or Rx)	BI_DC-		14	+ Auto Switch (Tx or Rx)	BI_DC+	
	15	- Auto Switch (Tx or Rx)	BI_DA-		16	+ Auto Switch (Tx or Rx)	BI_DA+	

Cabling

An adapter cable, part number CBR-1604, is available. This is a 12-inch, 16-pin Click-Mate to two RJ-45 connector cables.

If your application requires a custom cable, the following information will be useful:

EPU-3312 Board Connector	Mating Connector
Molex 503148-1690	Molex 503149-1600

Ethernet Status LEDs

Figure 28 shows the location of the Ethernet status LEDs.

- LED D10 – ■ indicates link activity on Ethernet port 0
- LED D11 – ■ indicates link activity on Ethernet port 1

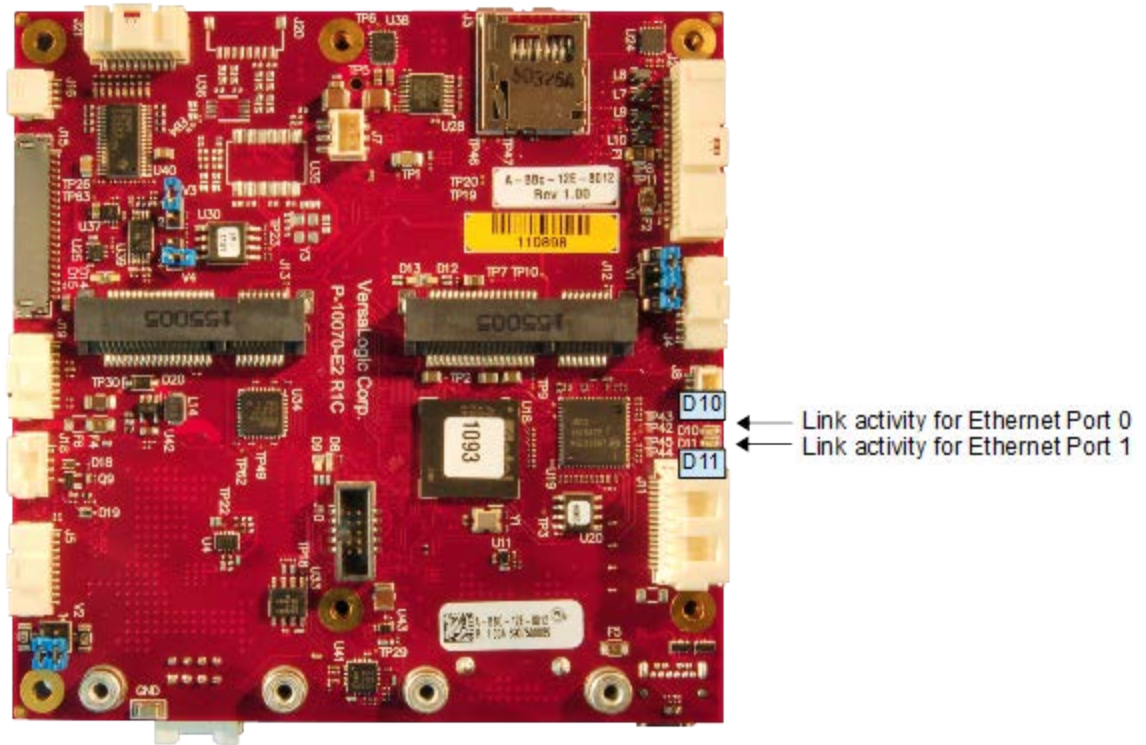

EP U3312_19

Figure 28. Onboard Ethernet Status LEDs

VL-CBR-4005B Paddleboard

VL-CBR-4005B Connectors and Indicators

Figure 29 shows the locations of the connectors, switches, and LEDs on the VL-CBR-4005B paddleboard.

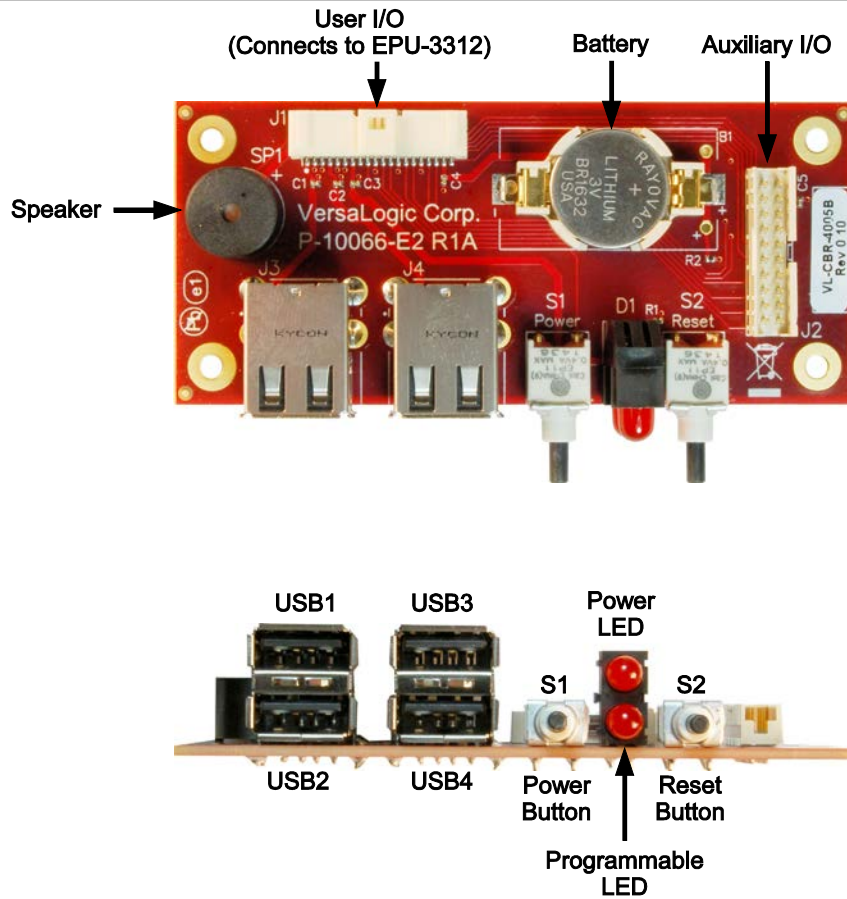

EPU3312_01

Figure 29. VL-CBR-4005B Connectors, Switches, and LEDs

User I/O Connector

Figure 30 shows the location and pin orientation of the user I/O connector.

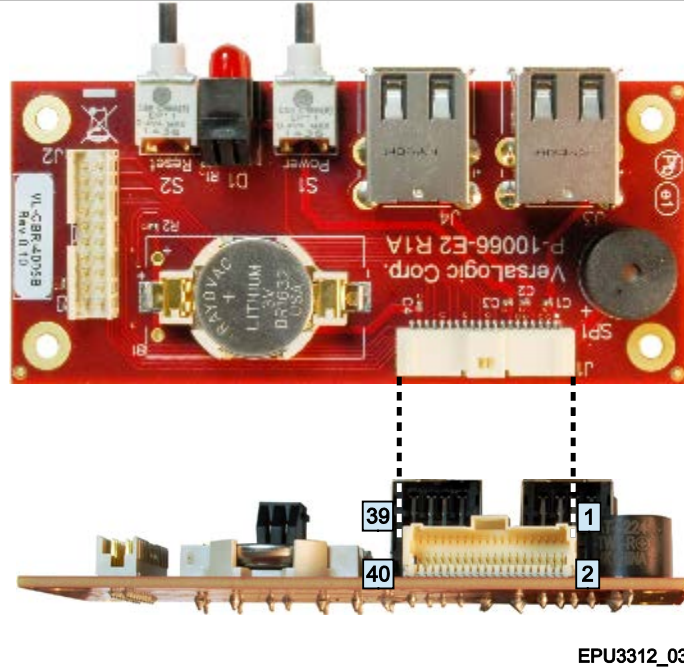

Figure 30. Location and Pin Orientation of the User I/O Connector

Table 18: User I/O Connector Pinout

Pin	Signal	Pin	Signal
1	+5 V	2	GND
3	USB1_P	4	USB2_P
5	USB1_N	6	USB2_N
7	+5V	8	GND
9	USB3_P	10	USB4_P
11	USB3_N	12	USB4_N
13	+3.3 V (Note 1)	14	GND
15	SPKR#	16	PLED#
17	PWR_BTN#	18	RST_BTN#
19	GND	20	GND
21	I2C Clock	22	V_BATT
23	I2C Data	24	V_BATT RETURN
25	GND	26	GND
27	GPIO1	28	GPIO2
29	GPIO3	30	GPIO4
31	GND	32	GND
33	GPIO5	34	GPIO6
35	GPIO7	36	GPIO8
37	+3.3 V (Note 2)	38	GND
39	ETH0 LED	40	ETH1 LED

Notes for Table 18:

1. This 3.3 V power goes off in sleep modes. The SPKR# uses this power as should the PLED# (there is no requirement for PLED# to use this power, but the VL-CBR-4005B paddleboard does).
2. This 3.3 V power can be turned on or off similar to the 3.3V power to the Mini Card via the FPGA (can go off in sleep modes or always stay on; by default it goes off in sleep modes). It is used for the 10 k Ω pullup resistor power on the 8x GPIOs and usually for the 2x Ethernet LEDs, however, the Ethernet LEDs can be powered by a 3.3 V power source.

Cabling

An adapter cable, part number CBR-4005A, is available for connecting the VL-CBR-4005B paddleboard to the EPU-3312. This is a 12-inch, Pico-Clasp 40-pin to 40-pin cable

If your application requires a custom cable, the following information will be useful:

CBR-4005B Board Connector	Mating Connector
Molex 501571-4007	Molex 501189-4010

On-board Battery



CAUTION:

To prevent shorting, premature failure or damage to the Lithium battery, do not place the board on a conductive surface such as metal, black conductive foam or the outside surface of a metalized ESD protective pouch. The Lithium battery may explode if mistreated. Do not recharge, disassemble, or dispose of the battery in fire. Dispose of used batteries promptly.

Nominal battery voltage is 3.0 V. If the voltage drops below 2.7 V, contact the factory for a replacement. The life expectancy under normal use is approximately five years.

Auxiliary I/O Connector

Figure 31 shows the location and pin orientation of the auxiliary I/O connector.

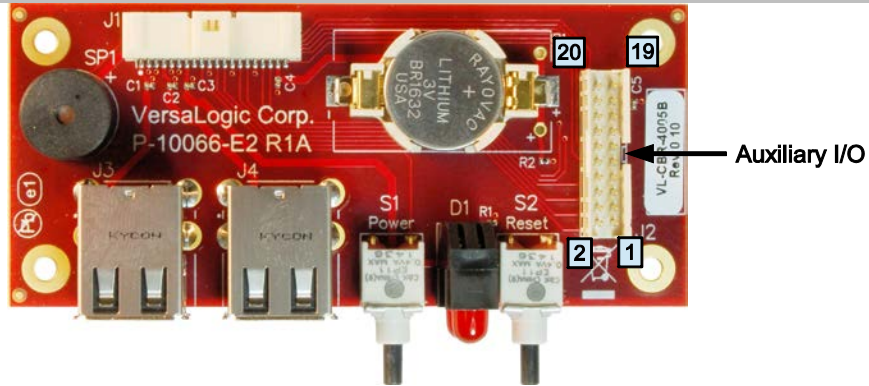

EPU3312_04

Figure 31. Location and Pin Orientation of Auxiliary I/O Connector

Table 19: Auxiliary I/O Connector Pinout

Pin	Signal	Pin	Signal
1	I2C Clock	2	V_BATT
3	I2C Data	4	V_BATT_RETURN
5	GND	6	GND
7	GPIO1	8	GPIO2
9	GPIO3	10	GPIO4
11	GND	12	GND
13	GPIO5	14	GPIO6
15	GPIO7	16	GPIO8
17	+3.3 V	18	GND
19	Ethernet Port 0 LED	20	Ethernet Port 1 LED

Dimensions and Mounting Holes

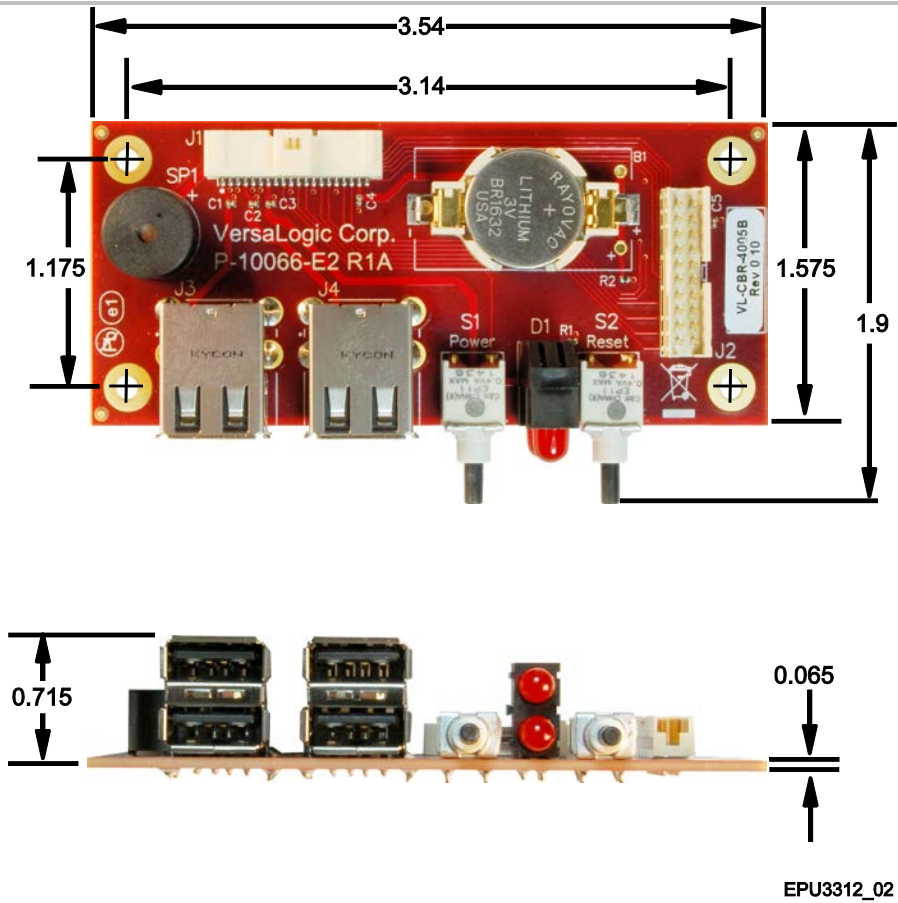
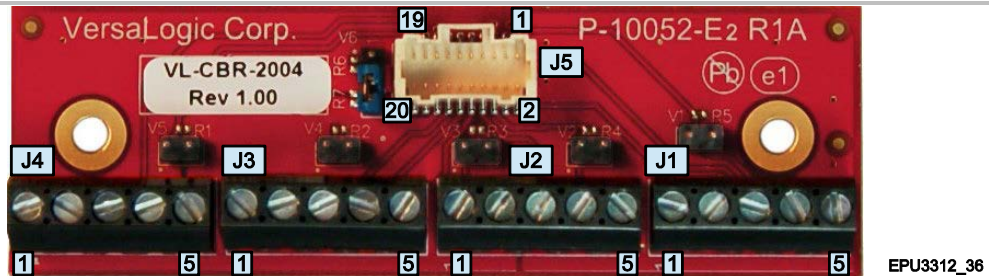

Figure 32. VL-CBR-4005B Dimensions and Mounting Holes

VL-CBR-2004B Paddleboard

To access the eight analog-to-digital inputs on the Raven, a paddleboard and 12-inch cable are available from VersaLogic, part number VL-CBR-2005. Figure 33 shows the locations and pin orientations of the connectors on the CBR-2004B paddleboard.



- J5 – Main I/O connector (mates with the Raven's analog-to-digital input connector)
- J4 – Reserved
- J3 – Analog inputs 6-8
- J2 – Analog inputs 4-5
- J1 – Analog inputs 1-3

Figure 33. CBR-2004B Connectors

Analog Input Connections

Figure 34 shows the specific analog input and ground connections when using the VL-CBR-2004 paddleboard with the Raven.

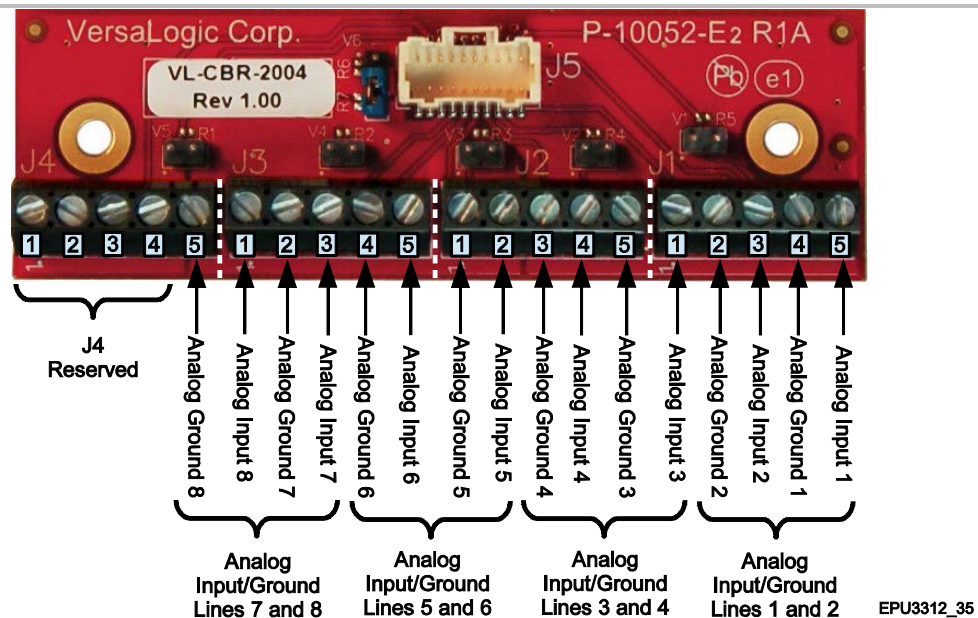
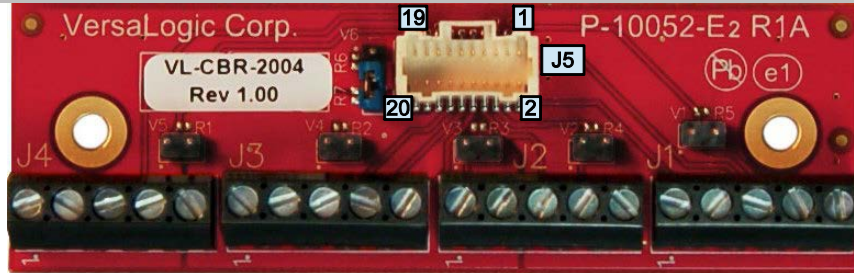

Figure 34. Analog Input and Ground Terminal Block Pinouts

Main I/O Connector

The main I/O connector mates with the Raven's analog-to-digital input connector. Figure 35 shows the location and pin orientation of the main I/O connector.



EPM31_28

Figure 35. Location and Pin Orientation of the Main I/O Connector

Table 20: Main I/O Connector Pinout

Pin	Signal	Pin	Signal
1	Analog Input 1	2	Analog Input 2
3	Analog Ground	4	Analog Ground
5	Analog Input 3	6	Analog Input 4
7	Analog Ground	8	Analog Ground
9	Analog Input 5	10	Analog Input 6
11	Analog Ground	12	Analog Ground
13	Analog Input 7	14	Analog Input 8
15	Analog Ground	16	Analog Ground
17	Digital Ground	18	Digital Ground
19	Reserved	20	Reserved

Cabling

An adapter cable is bundled with the VL-CBR-2004B paddleboard. This is a 12-inch, Pico-Clasp 20-pin to 20-pin cable

If your application requires a custom cable, the following information will be useful:

CBR-4005B Board Connector	Mating Connector
Molex 501571-2007	Molex 501189-2010

Dimensions and Mounting Holes

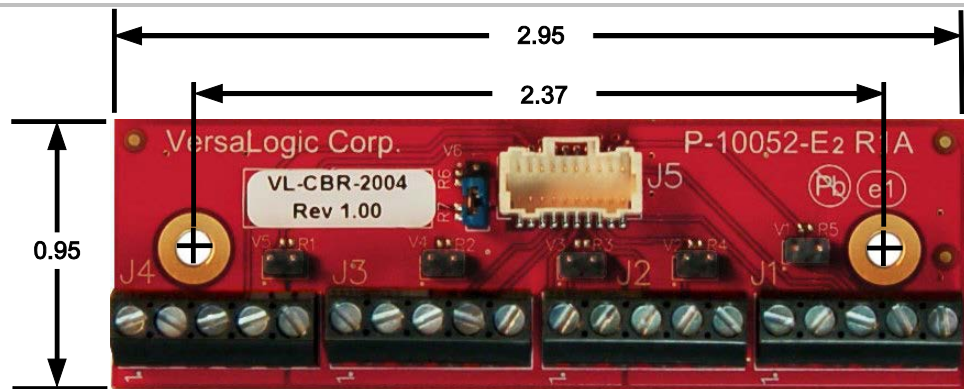

EPM31_24

Figure 36. CBR-2004B Dimensions and Mounting Holes

Thermal Considerations

This chapter discusses the following topics related to thermal issues:

- Selecting the correct thermal solution for your application
- EPU-3312 thermal characterization
- Installing the passive (HDW-406 heat sink), the active (HDW-415 fan), and the heat pipe block (HDW-408) thermal solutions available from VersaLogic

Selecting the Correct Thermal Solution for Your Application

This section provides guidelines for the overall system thermal engineering effort.

Heat Plate

The heat plate supplied with the Raven is the basis of the thermal solution. The heat plate draws heat away from the CPU chip as well as other critical components. Some components rely on the ambient air temperature at or below the maximum specified 85 °C temperature.

The design of the heat plate assumes that the user's thermal solution will maintain the top surface of the heat plate at 90 °C or less. If that temperature threshold is maintained, the CPU will remain safely within its operating temperature limits.



CAUTION:

By itself, the heat plate is not a complete thermal solution. Integrators should either implement a thermal solution using the accessories available from VersaLogic or develop their own thermal solution that attaches to the heat plate, suitable for environments in which the EPU-3312 will be used. As stated above, the thermal solution must be capable of keeping the top surface of the heat plate at or below 90 °C and the air surrounding the components in the assembly at or below 85 °C.

The heat plate is permanently affixed to the Raven and must not be removed. Removal of the heat plate voids the product warranty. Attempting to operate the Raven without the heat plate voids the product warranty and can damage the CPU.

System-level Considerations

The Raven is often mounted directly to another thermally controlled surface via its heat plate (that is, the inside surface of an enclosure). In this case, the user needs to maintain the heat plate at or below 90 °C by controlling the mounting surface temperature. The EPU-3312 thermal solutions available from VersaLogic – the HDW-406 heat sink with or without the HDW-415 fan, or the HDW-408 heat pipe block – can be used in the user's final system or only used during product development as a temporary bench-top solution.

The ambient air surrounding the EPU-3312 needs to be maintained at 85 °C or below. This may prove to be challenging depending on how and where the EPU-3312 is mounted in the end user system.

The decision which thermal solution to use relies on several factors including:

- Number of CPU cores in the SoC (single, dual, or quad)
- CPU and video processing utilization by the user application
- Temperature range within which the EPU-3312 will be operated
- Air movement (or lack of air movement)

Most of these factors involve the demands of the user application on the EPU-3312 and cannot be isolated from the overall thermal performance. Due to the interaction of the user application, the Raven thermal solution, and the overall environment of the end system, thermal performance cannot be rigidly defined.

The ambient air surrounding the EPU-3312 needs to be maintained at 85 °C or below. This would include the space between the two main boards as well as the space beneath an installed Mini PCIe expansion board. Standard methods for addressing this requirement include the following:

- Provide a typical airflow of 100 linear feet per minute (LFM) / 0.5 linear meters per second (as described in the section titled EPU-3312 Thermal Characterization, beginning on page 67) within the enclosure
- Position the EPU-3312 board to allow for convective airflow
- Lower the system level temperature requirement as needed

CPU Thermal Trip Points

The CPU cores in the Raven have their own thermal sensors. Coupled with these sensors are specific reactions to three thermal trip points. Table 21 describes the three thermal trip points. Note that these are internal temperatures that are about 10 °C above the heat plate temperature.

Table 21: CPU Thermal Trip Points

Trip Point	Description
Passive (Note 1)	At this temperature, the CPU cores throttle back to a lower speed. This reduces the power draw and heat dissipation, but lowers the processing speed.
Critical (Note 2)	At this temperature, the operating system typically puts the board into a sleep or other low-power state.
Maximum core temperature	The CPU turns itself off when this temperature is reached. This is a fixed trip point and cannot be adjusted.

Notes:

1. The default value in the BIOS Setup utility for this trip point is 90 °C.
2. The default value in the BIOS Setup utility for this trip point is 100 °C.

These trip points allow maximum CPU operational performance while maintaining the lowest CPU temperature possible. The long-term reliability of any electronic component degrades when it is continually run near its maximum thermal limit. Ideally, the CPU core temperatures will be kept well below 100 °C with only brief excursions above.

CPU temperature monitoring programs are available to run under both Windows and Linux. Table 22 lists some of these hardware monitoring programs.

Table 22: Temperature Monitoring Programs

Operating System	Program Type	Description
Windows	Core Temperature	http://www.alcpu.com/CoreTemp/
	Hardware Monitor	http://www.cpubid.com/software/hwmonitor.html
	Open Hardware Monitor	http://openhardwaremonitor.org/
Linux	lm-sensors	http://en.wikipedia.org/wiki/Lm_sensors

Thermal Specifications, Restrictions, and Conditions

Graphical test data is in the section titled EPU-3312 Thermal Characterization, beginning on page 67. Refer to that section for the details behind these specifications. These specifications are the thermal limits for using the EPU-3312 with one of the defined thermal solutions.

Due to the unknown nature of the entire thermal system, or the performance requirement of the application, VersaLogic cannot recommend a particular thermal solution. This information is intended to provide guidance in the design of an overall thermal system solution.

Table 23: Absolute Minimum and Maximum Air Temperatures

Board	With Heat Plate	With Heat Sink (HDW-406)	With Heat Sink + Fan (HDW-406 + HDW-415)
VL-EPU-3312-EAP	-40 ° to +85 °C	-40 ° to +85 °C	-40 ° to +85 °C
VL-EPU-3312-EBP	-40 ° to +85 °C	-40 ° to +85 °C	-40 ° to +85 °C
VL-EPU-3312-EDP	-40 ° to +85 °C	-40 ° to +85 °C	-40 ° to +85 °C

Overall Restrictions and Conditions:

- Ranges shown assume less than 90% CPU utilization.
- Keep the maximum CPU core temperature below 100°C.
- The ambient air surrounding the EPU-3312 needs to be maintained at 85 °C or below. This includes the space between the two main boards as well as the space beneath an installed Mini PCIe expansion board. A recommended overall airflow of 100 linear feet per minute (LFM) / 0.5 linear meters per second (LMS) addresses this requirement. If this air flow is not provided, other means must be implemented to keep the adjacent air at 85 °C or below.

Heat Plate Only Restrictions and Conditions:

- The heat plate must be kept below 90 °C. This applies to a heat plate mounted directly to another surface as well as when the HDW-408 heat pipe block is used.

Heat Sink Only Considerations:

- At 85°C air temperature and 90% CPU utilization, there will be little if any thermal margin to a CPU core temperature of 100 °C or the passive trip point (see test data). If this is the use case, consider adding a fan or other additional airflow.

Heat Sink with Fan Considerations:

- The heat sink and fan combination cools the CPU when it is running in high temperature environments, or when the application software is heavily utilizing the CPU or video circuitry. The fan assists in cooling the heat sink and provides additional air movement within the system.



Integrator’s Note: The ambient air surrounding the EPU-3312 needs to be maintained at 85 °C or below.

EPU-3312 Thermal Characterization

The EPU-3312 board underwent the following thermal characterization tests:

- Test Scenario 1: Single core EPU-3312-EAP + HDW-416 heat sink
- Test Scenario 2: Dual core EPU-3312-EBP + HDW-416 heat sink, with/without HDW-415 fan
- Test Scenario 3: Quad core EPU-3312-EDP + HDW-416 heat sink, with/without HDW-415 fan
- Test Scenario 4: Quad core EPU-3312-EDP + HDW-416 heat sink + HDW-408 heat pipe block, with/without HDW-415 fan

Table 24 describes the thermal testing setup for the board.

Table 24: EPU-3312 Thermal Testing Setup

Hardware configuration	<p>EPU-3312 (Raven) single/dual/quad core CPU with:</p> <ul style="list-style-type: none"> ▪ 4 GB of DDR3L DRAM (2 GB for the single- and dual-core board models) ▪ HDW-416 (passive heat sink) ▪ HDW-408 (heat pipe block) ▪ HDW-415 (heat sink fan) ▪ One VGA display device (connected through the LVDS interface), one display for monitor ▪ One SATA hard disk drive ▪ Two RS-232 ports in loopback configuration ▪ One VersaLogic VL-MPEe-E3 Mini PCIe Gigabit Ethernet module ▪ Two active Ethernet ports in loopback configuration ▪ Two USB 2.0 ports in loopback configuration (Note) ▪ USB keyboard and mouse (Note)
BIOS	<ul style="list-style-type: none"> ▪ ID string: Raven_3.1.0.334.r1.101 ▪ Passive thermal trip point setting: 105 °C ▪ Critical thermal trip point setting: 110 °C
Operating system	Microsoft Windows* 8.1
Test software	<ul style="list-style-type: none"> ▪ Passmark* BurnIn Test v8.1 b1016 - CPU utilization ~90% ▪ Intel Thermal Analysis Tool* (TAT) v5.0.1014 - Primarily used to read the CPU core temperature
Test environment	Thermal chamber

Note: This device connects through a VersaLogic VL-CBR-4005B paddleboard.

The test results reflect the test environment within the temperature chamber used. The airflow of this particular chamber is about 0.5 linear meters per second (~100 linear feet per minute). Thermal performance improves by increasing the airflow beyond 0.5 linear meters per second.

The system power dissipation is primarily dependent on the application program; that is, its use of computing or I/O resources. The stress levels used in this testing are at the top of the range of a typical user's needs.

Test Results

Test Scenario 1: Single Core EPU-3312-EAP + HDW-416 Heat Sink

At 90% CPU utilization this single core unit operates within the CPU’s core temperature safe operating range all the way up to +85 °C using only a heat sink.

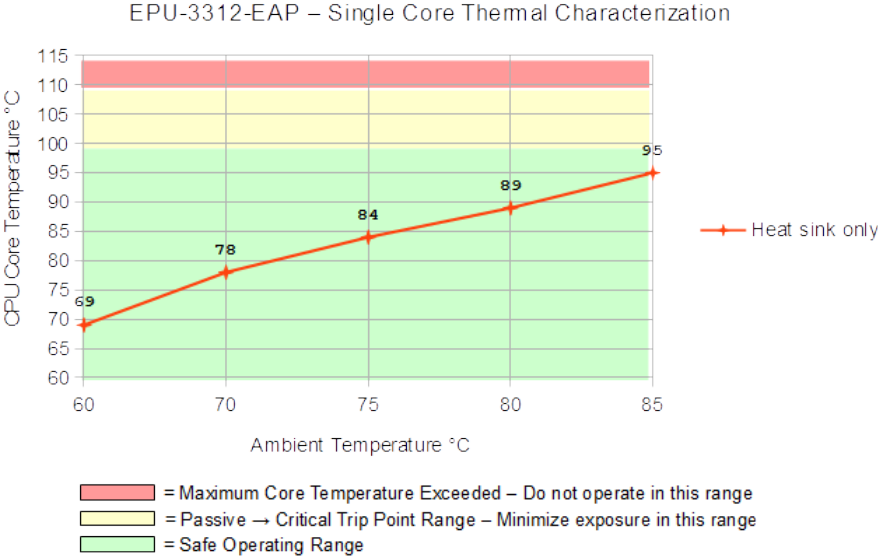

EPU3312_29

Figure 37. EPU-3312-EAP Single Core Temperature Relative to Ambient Temperature

Test Scenario 2: Dual Core EPU-3312-EBP + HDW-416 Heat Sink, with/without HDW-415 fan

As shown in Figure 38, running the test scenario with just the heat sink, the core temperature is slightly above 100 °C at maximum ambient temperature. This will be less in most applications that require less than 90% CPU utilization. Adding the fan provides an additional 5-6 °C of margin. For long-term reliability, ensure the CPU cores are predominately running with their temperatures below 100 °C.

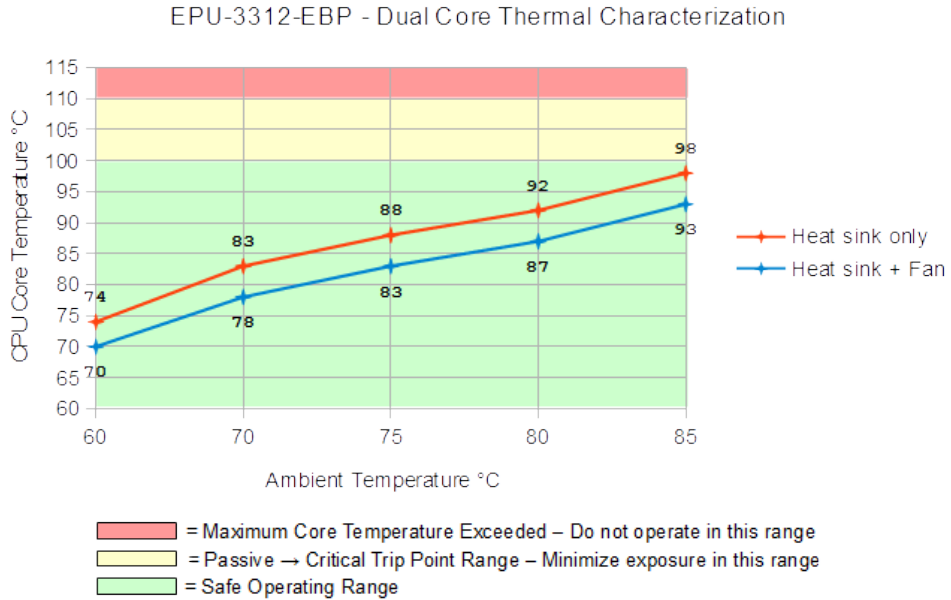

Figure 38. EPU-3312-EBP Dual Core Temperature Relative to Ambient Temperature

Test Scenario 3: Quad Core EPU-3312-EDP + HDW-416 Heat Sink, with/without HDW-415 Fan

As shown below, the quad core version of the Raven will typically require a heat sink + fan for operation above 80 °C, at >90% CPU utilization.

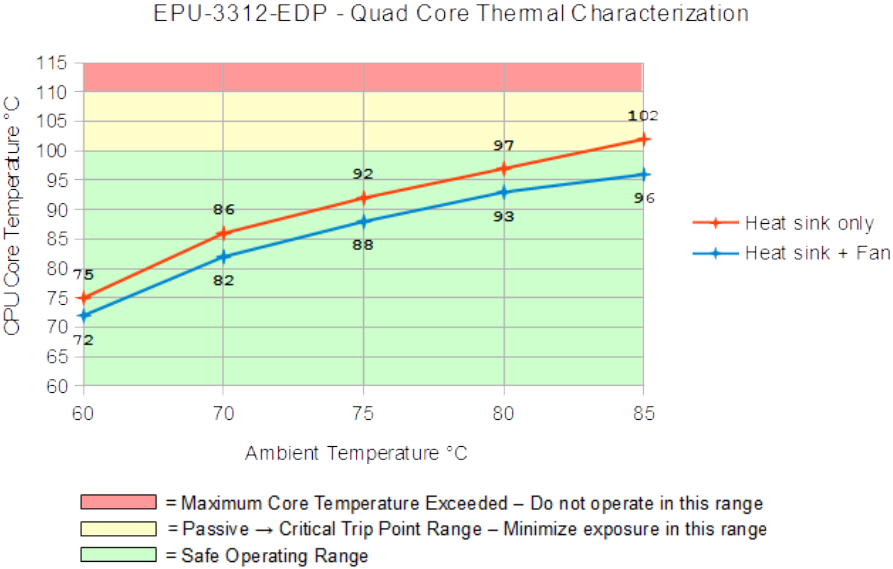

Figure 39. EPU-3312-EDP Quad Core Temperature Relative to Ambient Temperature

Test Scenario 4: Quad Core EPU-3312-EDP + HDW-408 Heat Pipe Block

This data is a reference point for custom heat pipe solutions.

Table 25: Heat Pipe Additional Configuration Details

Passive Solution Configuration	<p>HDW-408 Heat Pipe Block mounted to the EPU-3312 heat plate with:</p> <ul style="list-style-type: none"> ▪ Three 4 mm x 225 mm copper / water heat pipes ▪ The EPU-3312 is inside an environmental chamber at the noted temperatures <p>Thermal solution at far end of heat pipes:</p> <ul style="list-style-type: none"> ▪ HDW-408 heat pipe block attached to a HDW-406 heat sink ▪ The thermal solution is outside of the environmental chamber in free-air at an ambient temperature of 25 °C
Active Configuration	<ul style="list-style-type: none"> ▪ Same as above with an added HDW-415 fan on the HDW-406 heat sink

EPU-3312-EDP - Quad Core Thermal Characterization

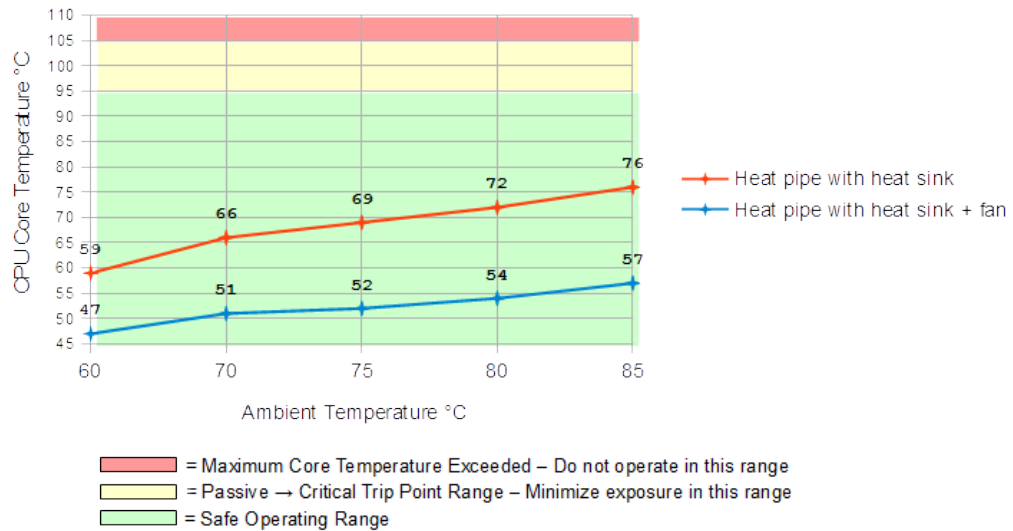

EPU3312_32

Figure 40. EPU-3312-EDP Quad Core with Heat Pipe - Temperature Relative to Ambient

Installing VersaLogic Thermal Solutions

The following thermal solution accessories are available from VersaLogic:

- VL-HDW-401 Thermal Compound Paste – used to mount the heat sink to the heat plate
- VL-HDW-416 Passive Heat Sink – mounts to standard product.
- VL-HDW-415 Fan Assembly – Cooling fan for the HDW-416 passive heatsink. Operates at +12 V and includes an EPU-3312 compatible connector
- VL-HDW-408 Heat Pipe Block – mounts to heat plate

Hardware Assembly

There are two basic assembly methods:

- Heat plate down (in relation to the enclosure)
- Heat plate up

These assembly methods are shown in Figure 41 and Figure 42, respectively.

Heat Plate Down

Figure 41 (a representative image of a similar VersaLogic product) shows the assembly. Use this assembly method if you are attaching the Raven to a larger thermal solution such as a metal chassis/enclosure.

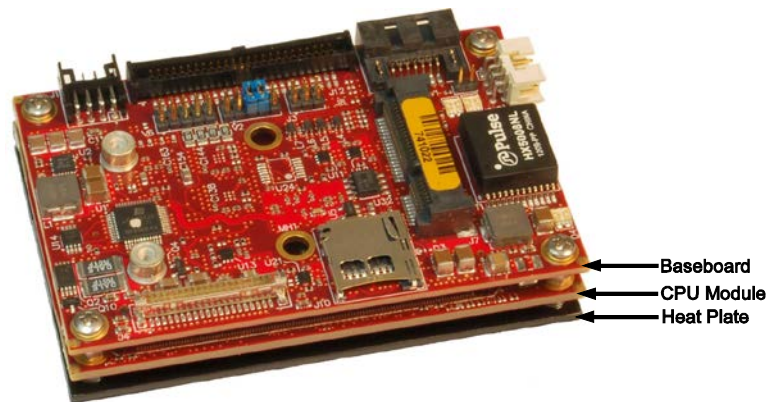

EPU3312-41

Figure 41. Hardware Assembly with Heat Plate Down

A thermal interface compound must be applied to the heat plate to thermally bond it to the mounting plate or other surface to which the Raven is mounted. Spread the compound thinly and evenly across the entire heat plate surface before mounting. The compound is supplied in the VL-CKR-RAVEN cable kit or sold separately as part number VL-HDW-401.

Heat Plate Up

Use this assembly method if you are adding a heatsink to the standard Raven heat plate. Figure 42 (a representative image of a similar VersaLogic product) shows the EPU-3310 assembly including the optional HDW-406 heatsink.

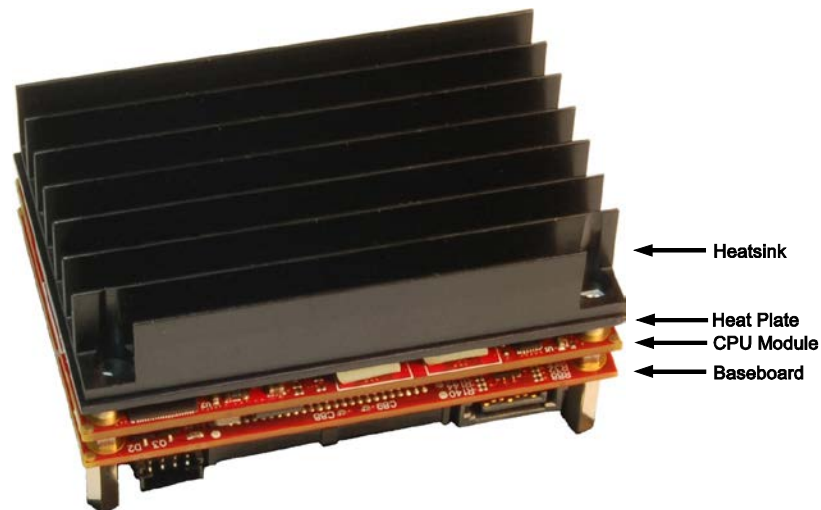

EPU3312-42

Figure 42. Hardware Assembly with Heat Plate Up

The recommended assembly method for this configuration is as follows:

1. Attach the heatsink to the Raven heat plate.
2. Attach the baseboard to the enclosure with standoffs.

Installing the VL-HDW-406 Passive Heat Sink

1. Apply the Arctic Silver[®] Thermal Compound (VL-HDW-416)

- Apply the thermal compound to the heat plate using the method described on the Arctic Silver website - <http://www.arcticsilver.com/>

2. Position the passive heat sink

- Using Figure 43 as a guide, align the five mounting holes of the heat sink with the heat plate.
- Orient the heat sink fins in the direction of the system airflow to maximize CPU cooling.

3. Secure the passive heat sink to the heat plate

- Affix the passive heat sink to the heat plate using five M2.5 pan head screws.
- Using a torque screwdriver, tighten the screws to 4.0 inch-pounds.

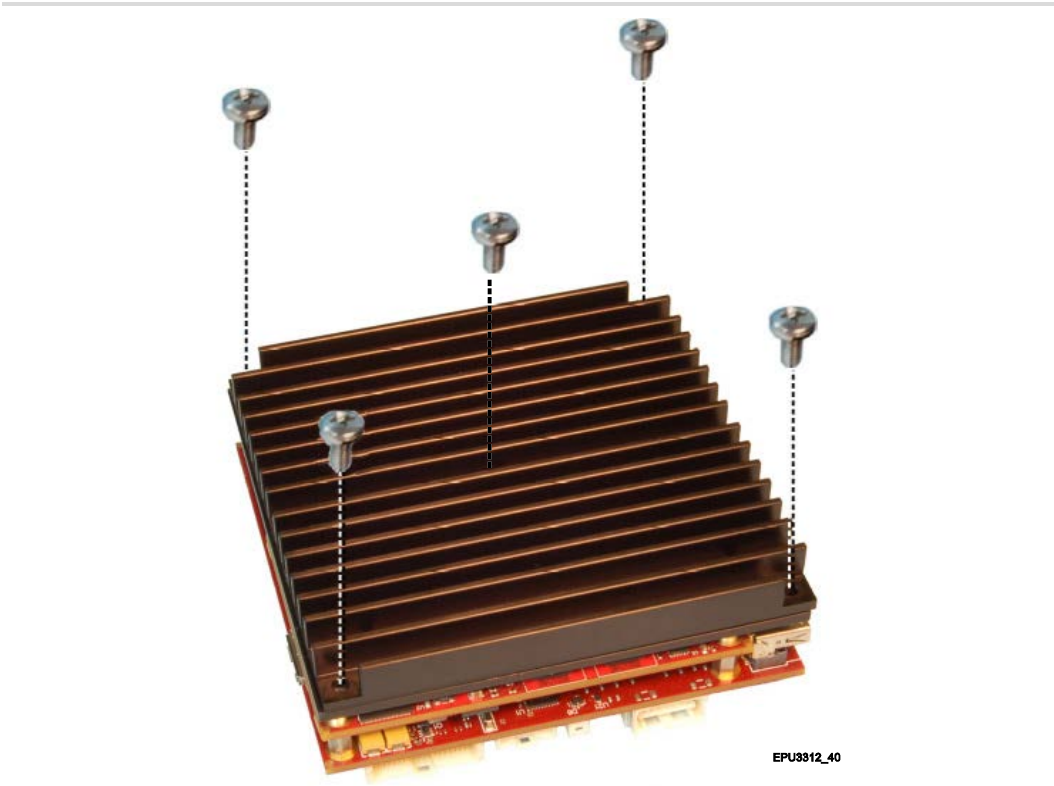

Figure 43. Installing the Passive Heat Sink

Installing the VL-HDW-415 Heat Sink Fan

1. Position the fan assembly

- Using Figure 44 as a guide, align the mounting holes of the heat sink fan with the four holes in the passive heat sink. Position the fan so that its power cable can easily reach its mate.

2. Secure the fan to the heat sink

- Affix the heat sink fan using four M3 pan head screws.
- Using a torque screwdriver, tighten the screws to 4.0 inch-pounds.

3. Connect power to the fan

- Connect the fan's power cable to J18 on the EPU-3312.

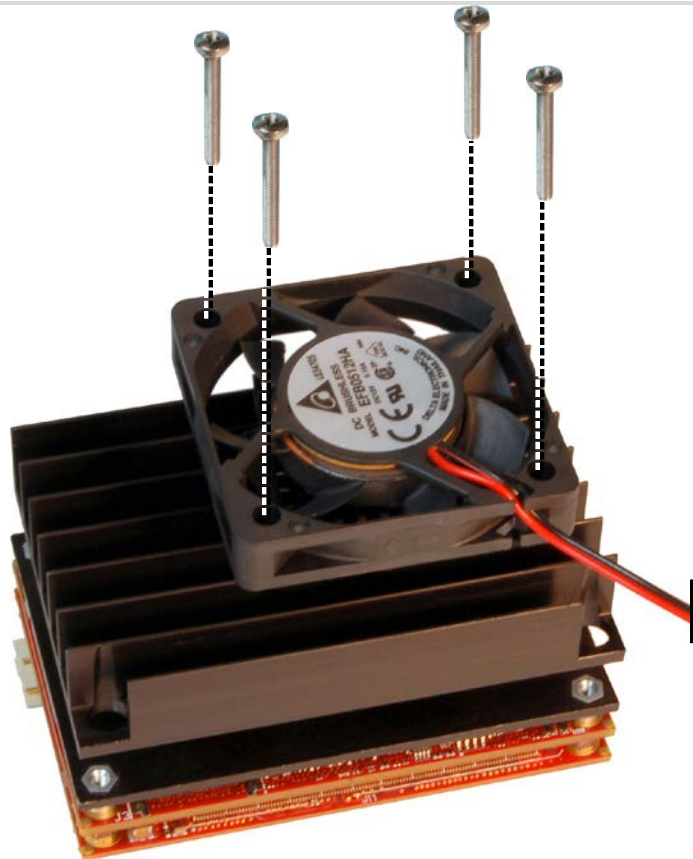

HAWK_26

Figure 44. Installing the Heat Sink Fan

Installing the VL-HDW-408 Heat Pipe Block

1. Apply the Arctic Silver Thermal Compound (VL-HDW-401)

- Apply the thermal compound to the heat plate using the method described on the Arctic Silver website - <http://www.arcticsilver.com/>. The 4 mm heat pipes will also typically have the thermal compound applied to where the pipes contact both the heat plate and the block.

2. Position the heat pipe block

- Using Figure 45 as a guide, align the six mounting holes of the heat pipe block with the heat plate. (Figure 45 shows the heat pipe block installed.)

3. Secure the heat pipe block to the heat plate

- Affix the heat pipe block to the heat plate using six M2.5-0.45 x 10mm, Phillips, pan head screws.
 - Using a torque screwdriver, tighten the screws to 4.0 inch-pounds.
-

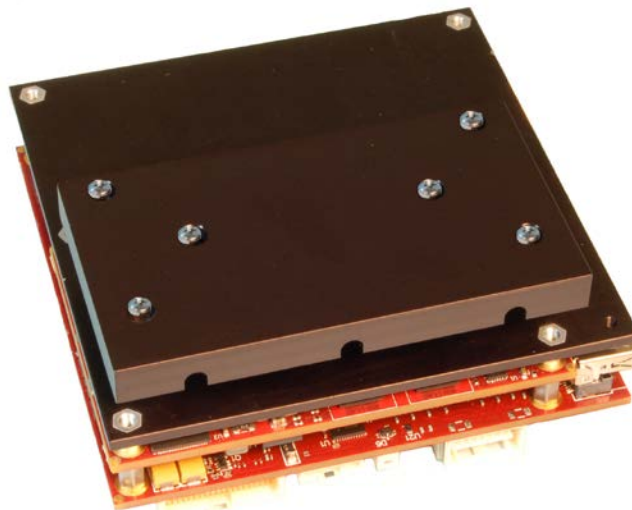

Figure 45. Installing the Heat Pipe Block

Hardware

- A microSD card cannot be removed or inserted if certain cables are attached to the micro USB 3.0 connector. Many USB 3.0 cables have a housing that is thick enough to obstruct access to the microSD socket. Some cables will not produce this limitation.

Operating Systems

- In Linux, a dual-display configuration (using both the LVDS and the Mini DisplayPort++ connectors) will fail to show output on the LVDS port unless the operating system is configured to boot in UEFI mode. Single display configurations do not have an issue.
- In Ubuntu 14.04, if an LVDS monitor goes into power saving mode or the operating system goes into suspend or hibernate mode, the LVDS monitor will fail to come back on.

BIOS

- An installed microSD card disappears from Windows Device Manager after the board enters an S3 state. Extracting/re-inserting the microSD card does not bring it back; the board must be rebooted for Windows to recognize the microSD card again.
- In the USB Configuration menu, disabling the xHCI controller without enabling the EHCI controller prevents the use of all USB devices, including the keyboard. Without a keyboard to navigate BIOS Setup utility, the board may need to be returned to VersaLogic for repair.

*** *End of document* ***