

## EMIPAK-2B PressFit Power Module 3-Levels Half-Bridge Inverter Stage, 150 A



EMIPAK-2B  
(package example)

### FEATURES

- Trench IGBT technology
- FRED Pt® clamping diodes
- PressFit pins technology
- Exposed Al<sub>2</sub>O<sub>3</sub> substrate with low thermal resistance
- Short circuit rated
- Square RBSOA
- Integrated thermistor
- Low internal inductances
- Low switching loss
- PressFit pins locking technology. Patent # US.263.820 B2
- UL approved file E78996
- Material categorization: for definitions of compliance please see [www.vishay.com/doc?99912](http://www.vishay.com/doc?99912)



RoHS  
COMPLIANT

PRODUCT SUMMARY	
<b>Q1 to Q4 IGBT</b>	
V <sub>CES</sub>	650 V
V <sub>CE(ON)</sub> typical at I <sub>C</sub> = 150 A	1.70 V
I <sub>C</sub> at T <sub>C</sub> = 82 °C	150 A
Speed	8 kHz to 30 kHz
Package	EMIPAK-2B
Circuit	3-levels half bridge inverter stage

### DESCRIPTION

VS-ETF150Y65N is an integrated solution for a multi level inverter stage in a single package. The EMIPAK-2B package is easy to use thanks to the PressFit pins and the exposed substrate provides improved thermal performance. The optimized layout also helps to minimize stray parameters, allowing for better EMI performance.

ABSOLUTE MAXIMUM RATINGS				
PARAMETER	SYMBOL	TEST CONDITIONS	MAX.	UNITS
Operating junction temperature	T <sub>J</sub>		175	°C
Storage temperature range	T <sub>Stg</sub>		-40 to +150	
RMS isolation voltage	V <sub>ISOL</sub>	T <sub>J</sub> = 25 °C, all terminals shorted, f = 50 Hz, t = 1 s	3500	V
<b>Q1 to Q4 IGBT</b>				
Collector to emitter voltage	V <sub>CES</sub>		650	V
Gate to emitter voltage	V <sub>GES</sub>		20	
Pulsed collector current	I <sub>CM</sub>		450	A
Clamped inductive load current	I <sub>LM</sub>		180	
Continuous collector current	I <sub>C</sub>	T <sub>C</sub> = 25 °C	201	A
		T <sub>C</sub> = 60 °C	171	
		T <sub>SINK</sub> = 60 °C	77	
Power dissipation	P <sub>D</sub>	T <sub>C</sub> = 25 °C	600	W
		T <sub>C</sub> = 60 °C	460	

PATENT(S): [www.vishay.com/patents](http://www.vishay.com/patents)

This Vishay product is protected by one or more United States and International patents.



ABSOLUTE MAXIMUM RATINGS				
PARAMETER	SYMBOL	TEST CONDITIONS	MAX.	UNITS
<b>D5 - D6 CLAMPING DIODE</b>				
Repetitive peak reverse voltage	$V_{RRM}$		650	V
Single pulse forward current	$I_{FSM}$	10 ms sine or 6 ms rectangular pulse, $T_J = 25\text{ }^\circ\text{C}$	750	A
Diode continuous forward current	$I_F$	$T_C = 25\text{ }^\circ\text{C}$	161	
		$T_C = 60\text{ }^\circ\text{C}$	140	
Power dissipation	$P_D$	$T_C = 25\text{ }^\circ\text{C}$	319	W
		$T_C = 60\text{ }^\circ\text{C}$	245	
<b>D1 - D2 - D3 - D4 AP DIODE</b>				
Single pulse forward current	$I_{FSM}$	10 ms sine or 6 ms rectangular pulse, $T_J = 25\text{ }^\circ\text{C}$	500	A
Diode continuous forward current	$I_F$	$T_C = 25\text{ }^\circ\text{C}$	102	
		$T_C = 60\text{ }^\circ\text{C}$	92	
Power dissipation	$P_D$	$T_C = 25\text{ }^\circ\text{C}$	238	W
		$T_C = 60\text{ }^\circ\text{C}$	182	

**Notes**

- Absolute Maximum Ratings indicate sustained limits beyond which damage to the device may occur.
- (1)  $V_{CC} = 325\text{ V}$ ,  $V_{GE} = 15\text{ V}$ ,  $L = 500\text{ }\mu\text{H}$ ,  $R_g = 4.7\text{ }\Omega$ ,  $T_J = 175\text{ }^\circ\text{C}$

ELECTRICAL SPECIFICATIONS ( $T_J = 25\text{ }^\circ\text{C}$ unless otherwise noted)						
PARAMETER	SYMBOL	TEST CONDITIONS	MIN.	TYP.	MAX.	UNITS
<b>Q1 to Q4 IGBT</b>						
Collector to emitter breakdown voltage	$BV_{CES}$	$V_{GE} = 0\text{ V}$ , $I_C = 100\text{ }\mu\text{A}$	650	-	-	V
Collector to emitter voltage	$V_{CE(ON)}$	$V_{GE} = 15\text{ V}$ , $I_C = 150\text{ A}$	-	1.70	2.17	
		$V_{GE} = 15\text{ V}$ , $I_C = 150\text{ A}$ , $T_J = 125\text{ }^\circ\text{C}$	-	1.95	-	
Gate threshold voltage	$V_{GE(th)}$	$V_{CE} = V_{GE}$ , $I_C = 5.0\text{ mA}$	5.0	6.0	8.4	
Temperature coefficient of threshold voltage	$\Delta V_{GE(th)}/\Delta T_J$	$V_{CE} = V_{GE}$ , $I_C = 1.0\text{ mA}$ ( $25\text{ }^\circ\text{C}$ to $125\text{ }^\circ\text{C}$ )	-	-18	-	mV/ $^\circ\text{C}$
Forward transconductance	$g_{fe}$	$V_{CE} = 20\text{ V}$ , $I_C = 150\text{ A}$	-	102	-	S
Transfer characteristics	$V_{GE}$	$V_{CE} = 20\text{ V}$ , $I_C = 150\text{ A}$	-	10.2	-	V
Zero gate voltage collector current	$I_{CES}$	$V_{GE} = 0\text{ V}$ , $V_{CE} = 650\text{ V}$	-	0.1	100	$\mu\text{A}$
		$V_{GE} = 0\text{ V}$ , $V_{CE} = 650\text{ V}$ , $T_J = 125\text{ }^\circ\text{C}$	-	130	-	
Gate to emitter leakage current	$I_{GES}$	$V_{GE} = \pm 20\text{ V}$ , $V_{CE} = 0\text{ V}$	-	-	$\pm 600$	nA
<b>D5 - D6 CLAMPING DIODE</b>						
Cathode to anode blocking voltage	$V_{BR}$	$I_R = 500\text{ }\mu\text{A}$	650	-	-	V
Forward voltage drop	$V_{FM}$	$I_F = 100\text{ A}$	-	1.64	2.0	
		$I_F = 100\text{ A}$ , $T_J = 125\text{ }^\circ\text{C}$	-	1.35	-	
Reverse leakage current	$I_{RM}$	$V_R = 650\text{ V}$	-	0.3	100	$\mu\text{A}$
		$V_R = 650\text{ V}$ , $T_J = 125\text{ }^\circ\text{C}$	-	100	-	
<b>D1 - D2 - D3 - D4 AP DIODE</b>						
Forward voltage drop	$V_{FM}$	$I_F = 100\text{ A}$	-	2.1	2.9	V
		$I_F = 100\text{ A}$ , $T_J = 125\text{ }^\circ\text{C}$	-	1.64	-	



<b>SWITCHING CHARACTERISTICS</b> ( $T_J = 25\text{ }^\circ\text{C}$ unless otherwise noted)							
PARAMETER	SYMBOL	TEST CONDITIONS	MIN.	TYP.	MAX.	UNITS	
<b>Q1 to Q4 IGBT</b>							
Total gate charge (turn-on)	$Q_g$	$I_C = 150\text{ A}$ $V_{CC} = 400\text{ V}$ $V_{GE} = 15\text{ V}$	-	310	-	nC	
Gate to emitter charge (turn-on)	$Q_{ge}$		-	95	-		
Gate to collector charge (turn-on)	$Q_{gc}$		-	130	-		
Input capacitance	$C_{ies}$	$V_{GE} = 0\text{ V}$ $V_{CC} = 30\text{ V}$ $f = 1\text{ MHz}$	-	9900	-	pF	
Output capacitance	$C_{oes}$		-	460	-		
Reverse transfer capacitance	$C_{res}$		-	250	-		
<b>Q1 and Q4 IGBT with D5 and D6 CLAMP DIODE</b>							
Turn-on switching loss	$E_{ON}$	$I_C = 150\text{ A}$ $V_{CC} = 325\text{ V}$ $V_{GE} = 15\text{ V}$ $R_g = 4.7\text{ }\Omega$ $L = 500\text{ }\mu\text{H}^{(1)}$	-	0.69	-	mJ	
Turn-off switching loss	$E_{OFF}$		-	3.4	-		
Total switching loss	$E_{TOT}$		-	4.1	-		
Turn-on delay time	$t_{d(on)}$		$I_C = 150\text{ A}$ $V_{CC} = 325\text{ V}$ $V_{GE} = 15\text{ V}$ $R_g = 4.7\text{ }\Omega$ $L = 500\text{ }\mu\text{H}^{(1)}$ $T_J = 125\text{ }^\circ\text{C}^{(1)}$	-	161	-	ns
Rise time	$t_r$			-	108	-	
Turn-off delay time	$t_{d(off)}$			-	139	-	
Fall time	$t_f$			-	91	-	
Turn-on switching loss	$E_{ON}$	$I_C = 150\text{ A}$ $V_{CC} = 325\text{ V}$ $V_{GE} = 15\text{ V}$ $R_g = 4.7\text{ }\Omega$ $L = 500\text{ }\mu\text{H}^{(1)}$ $T_J = 125\text{ }^\circ\text{C}^{(1)}$	-	0.9	-	mJ	
Turn-off switching loss	$E_{OFF}$		-	4.2	-		
Total switching loss	$E_{TOT}$		-	5.1	-		
Turn-on delay time	$t_{d(on)}$		$I_C = 150\text{ A}$ $V_{CC} = 325\text{ V}$ $V_{GE} = 15\text{ V}$ $R_g = 4.7\text{ }\Omega$ $L = 500\text{ }\mu\text{H}^{(1)}$ $T_J = 125\text{ }^\circ\text{C}^{(1)}$	-	160	-	ns
Rise time	$t_r$			-	109	-	
Turn-off delay time	$t_{d(off)}$			-	150	-	
Fall time	$t_f$			-	97	-	
<b>Q2 and Q3 IGBT with D2 and D3 AP DIODE</b>							
Turn-on switching loss	$E_{ON}$	$I_C = 150\text{ A}$ $V_{CC} = 325\text{ V}$ $V_{GE} = 15\text{ V}$ $R_g = 4.7\text{ }\Omega$ $L = 500\text{ }\mu\text{H}^{(1)}$	-	0.8	-	mJ	
Turn-off switching loss	$E_{OFF}$		-	4.0	-		
Total switching loss	$E_{TOT}$		-	4.8	-		
Turn-on delay time	$t_{d(on)}$		$I_C = 150\text{ A}$ $V_{CC} = 325\text{ V}$ $V_{GE} = 15\text{ V}$ $R_g = 4.7\text{ }\Omega$ $L = 500\text{ }\mu\text{H}^{(1)}$	-	144	-	ns
Rise time	$t_r$			-	117	-	
Turn-off delay time	$t_{d(off)}$			-	144	-	
Fall time	$t_f$			-	98	-	
Turn-on switching loss	$E_{ON}$	$I_C = 150\text{ A}$ $V_{CC} = 325\text{ V}$ $V_{GE} = 15\text{ V}$ $R_g = 4.7\text{ }\Omega$ $L = 500\text{ }\mu\text{H}^{(1)}$ $T_J = 125\text{ }^\circ\text{C}^{(1)}$	-	0.98	-	mJ	
Turn-off switching loss	$E_{OFF}$		-	4.7	-		
Total switching loss	$E_{TOT}$		-	5.7	-		
Turn-on delay time	$t_{d(on)}$		$I_C = 150\text{ A}$ $V_{CC} = 325\text{ V}$ $V_{GE} = 15\text{ V}$ $R_g = 4.7\text{ }\Omega$ $L = 500\text{ }\mu\text{H}^{(1)}$ $T_J = 125\text{ }^\circ\text{C}^{(1)}$	-	166	-	ns
Rise time	$t_r$			-	120	-	
Turn-off delay time	$t_{d(off)}$			-	153	-	
Fall time	$t_f$			-	106	-	
Reverse bias safe operating area	RBSOA	$T_J = 175\text{ }^\circ\text{C}$ , $I_C = 180\text{ A}$ , $V_{CC} = 325\text{ V}$ , $V_P = 650\text{ V}$ , $R_g = 4.7\text{ }\Omega$ , $V_{GE} = 15\text{ V to } 0\text{ V}$	Fullsquare				
Short circuit safe operating area	SCSOA	$R_g = 5.0\text{ }\Omega$ , $V_{CC} = 400\text{ V}$ , $V_P = 600\text{ V}$ , $V_{GE} = 15\text{ V to } 0$ , $T_J = 150\text{ }^\circ\text{C}$	-	-	5.5	$\mu\text{s}$	



<b>SWITCHING CHARACTERISTICS</b> ( $T_J = 25\text{ }^\circ\text{C}$ unless otherwise noted)						
PARAMETER	SYMBOL	TEST CONDITIONS	MIN.	TYP.	MAX.	UNITS
<b>D5 - D6 CLAMPING DIODE</b>						
Diode reverse recovery time	$t_{rr}$	$V_R = 200\text{ V}$ $I_F = 50\text{ A}$ $di/dt = 500\text{ A}/\mu\text{s}$	-	78	-	ns
Diode peak reverse current	$I_{rr}$		-	11	-	A
Diode recovery charge	$Q_{rr}$		-	433	-	nC
Diode reverse recovery time	$t_{rr}$	$V_R = 200\text{ V}$ $I_F = 50\text{ A}$ $di/dt = 500\text{ A}/\mu\text{s}, T_J = 125\text{ }^\circ\text{C}$	-	155	-	ns
Diode peak reverse current	$I_{rr}$		-	28	-	A
Diode recovery charge	$Q_{rr}$		-	2150	-	nC
<b>D1 - D2 - D3 - D4 AP DIODE</b>						
Diode reverse recovery time	$t_{rr}$	$V_R = 200\text{ V}$ $I_F = 50\text{ A}$ $di/dt = 500\text{ A}/\mu\text{s}$	-	82	-	ns
Diode peak reverse current	$I_{rr}$		-	11	-	A
Diode recovery charge	$Q_{rr}$		-	363	-	nC
Diode reverse recovery time	$t_{rr}$	$V_R = 200\text{ V}$ $I_F = 50\text{ A}$ $di/dt = 500\text{ A}/\mu\text{s}, T_J = 125\text{ }^\circ\text{C}$	-	134	-	ns
Diode peak reverse current	$I_{rr}$		-	22	-	A
Diode recovery charge	$Q_{rr}$		-	1500	-	nC

**Note**

(1) Energy losses include “tail” and diode reverse recovery.

<b>INTERNAL NTC - THERMISTOR SPECIFICATIONS</b>				
PARAMETER	SYMBOL	TEST CONDITIONS	TYP.	UNITS
Resistance	R25	$T_J = 25\text{ }^\circ\text{C}$	$5000 \pm 5\%$	$\Omega$
	R125	$T_J = 100\text{ }^\circ\text{C}$	$493 \pm 5\%$	
B-constant	B	$R_2 = R_{25} \exp. [B_{25/50} (1/T_2 - 1/(298.15\text{ K}))]$	$3375 \pm 5\%$	K
Temperature range			-40 to +125	$^\circ\text{C}$
Maximum operating temperature			220	
Dissipation constant			2	mW/ $^\circ\text{C}$
Thermal time constant			8	s

<b>THERMAL AND MECHANICAL SPECIFICATIONS</b>					
PARAMETER	SYMBOL	MIN.	TYP.	MAX.	UNITS
Q1 to Q4 IGBT- junction to case thermal resistance (per switch)	$R_{thJC}$	-	-	0.25	$^\circ\text{C}/\text{W}$
D5 - D6 Clamping diode - junction to case thermal resistance (per diode)		-	-	0.47	
D1 - D2 - D3 - D4 AP diode - junction to case thermal resistance (per diode)		-	-	0.63	
Q1 to Q4 IGBT - case to sink thermal resistance (per switch)	$R_{thCS}^{(1)}$	-	0.62	-	
D5 - D6 Clamping diode - case to sink thermal resistance (per diode)		-	0.7	-	
D1 - D2 - D3 - D4 AP diode - case to sink thermal resistance (per diode)		-	0.7	-	
Case to sink thermal resistance per module		-	0.1	-	
Mounting torque (M4)		2	-	3	Nm
Weight		-	45	-	g

**Note**

(1) Mounting surface flat, smooth, and greased

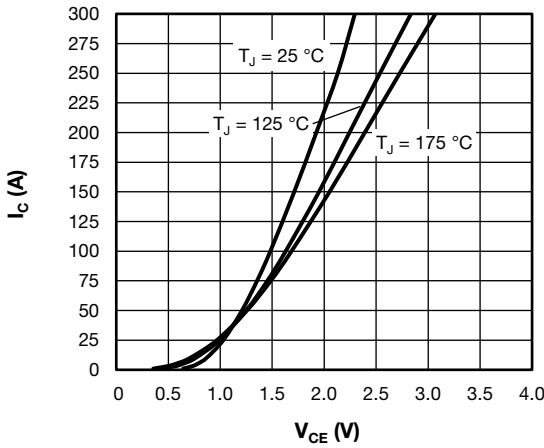

Fig. 1 -  $I_C$  vs.  $V_{CE}$ ,  
Typical Q1 to Q4 Trench IGBT Output Characteristics,  
 $V_{GE} = 15\text{ V}$

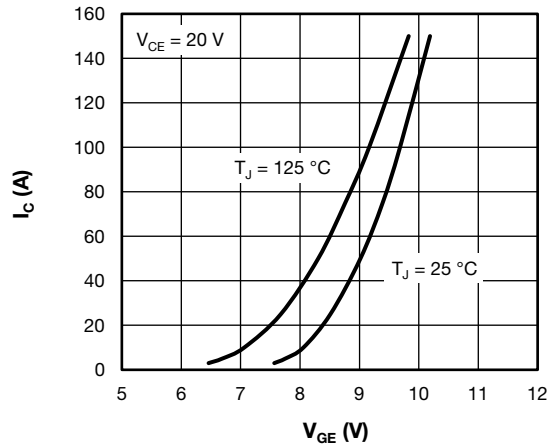

Fig. 4 -  $I_C$  vs  $V_{GE}$   
Typical Q1 to Q4 Trench IGBT Transfer Characteristics

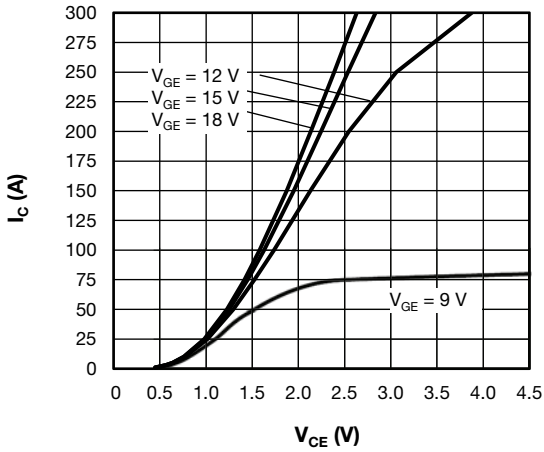

Fig. 2 -  $I_C$  vs.  $V_{CE}$   
Typical Q1 to Q4 Trench IGBT Output Characteristics,  
 $T_J = 125\text{ °C}$

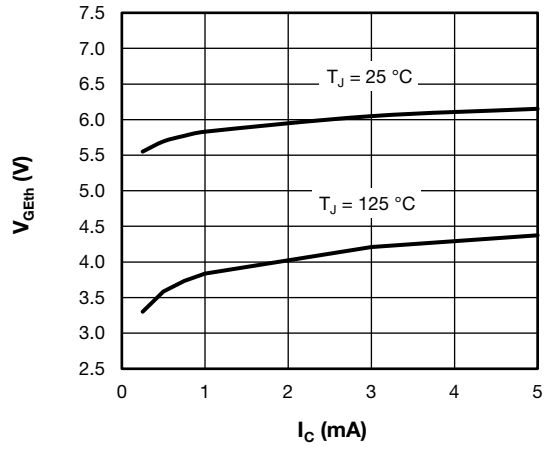

Fig. 5 -  $V_{Geth}$  vs.  $I_C$   
Typical Q1 to Q4 Trench IGBT Gate Threshold Voltage

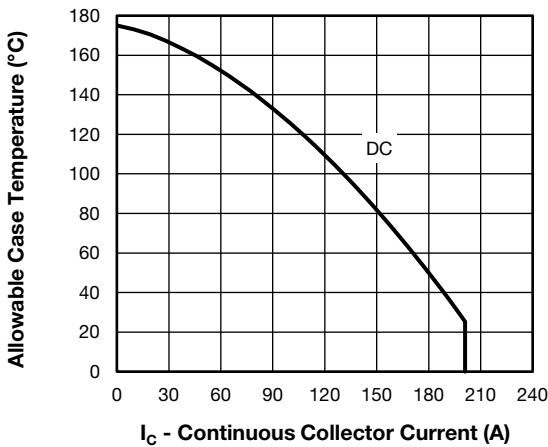

Fig. 3 - Allowable Case Temperature vs. Continuous Collector Current,  
Maximum Q1 to Q4 Trench IGBT Continuous Collector Current vs.  
Case Temperature

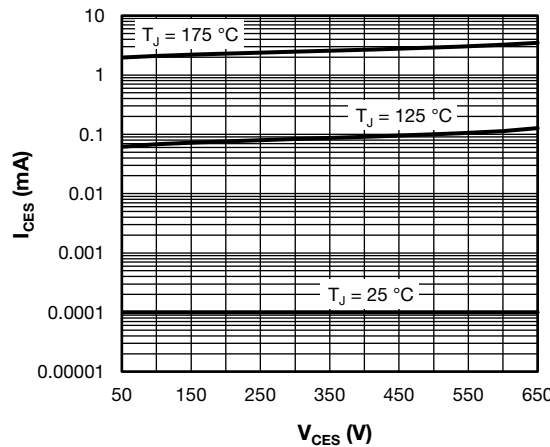

Fig. 6 -  $I_{CES}$  vs  $V_{CES}$   
Typical Q1 to Q4 Trench IGBT Zero Gate Voltage Collector Current

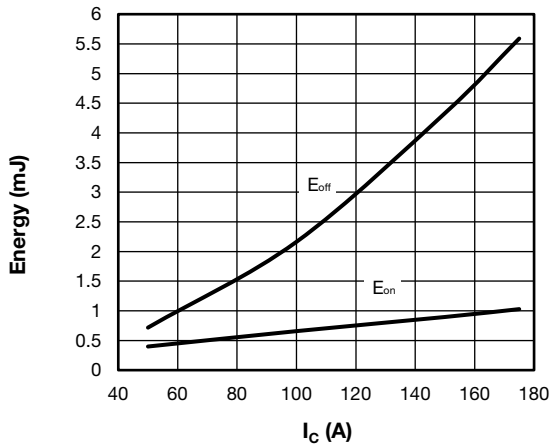

Fig. 7 - Energy Loss vs.  $I_C$   
(Typical Q1 - Q4 Trench IGBT Energy Loss vs.  $I_C$   
(with D5 - D6 Clamping Diode)),

$T_J = 125^\circ\text{C}$ ,  $V_{CC} = 325\text{ V}$ ,  $R_g = 4.7\ \Omega$ ,  $V_{GE} = \pm 15\text{ V}$ ,  $L = 500\ \mu\text{H}$

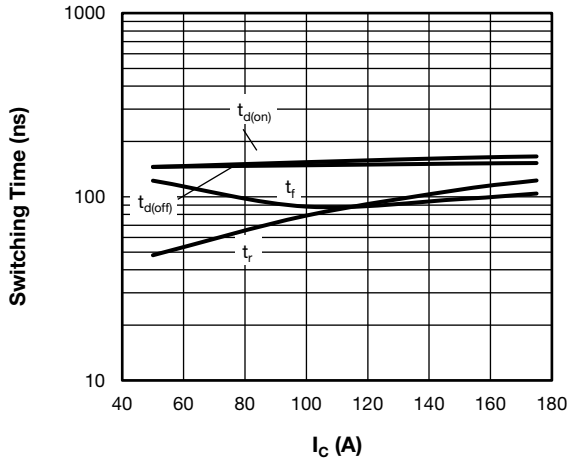

Fig. 8 - Switching Time vs.  $I_C$   
(Typical Q1 - Q4 Trench IGBT Switching Time vs.  $I_C$   
(with D5 - D6 Clamping Diode)),

$T_J = 125^\circ\text{C}$ ,  $V_{CC} = 325\text{ V}$ ,  $R_g = 4.7\ \Omega$ ,  $V_{GE} = \pm 15\text{ V}$ ,  $L = 500\ \mu\text{H}$

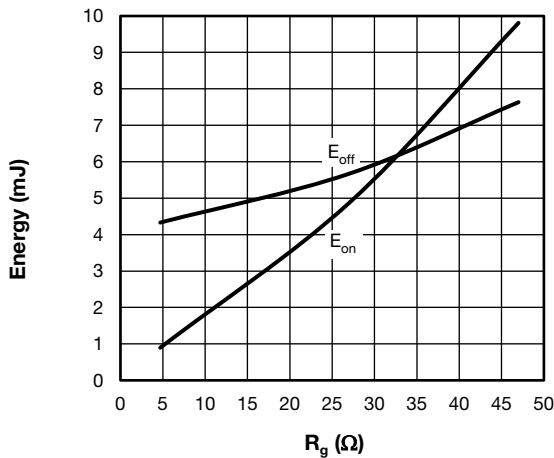

Fig. 9 - Energy Loss vs.  $R_g$   
(Typical Q1 - Q4 Trench IGBT Energy Loss vs.  $R_g$   
(with D5 - D6 Clamping Diode)),

$T_J = 125^\circ\text{C}$ ,  $V_{CC} = 325\text{ V}$ ,  $I_C = 150\text{ A}$ ,  $V_{GE} = \pm 15\text{ V}$ ,  $L = 500\ \mu\text{H}$

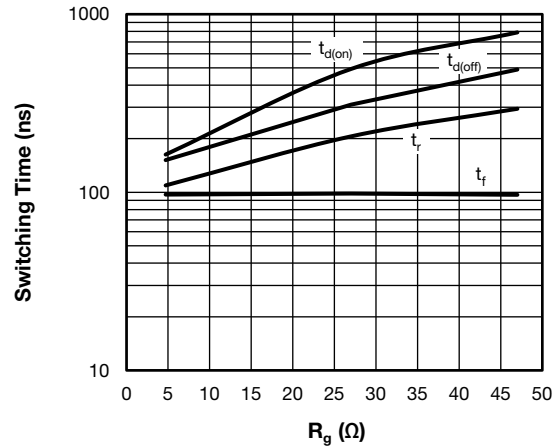

Fig. 10 - Switching Time vs.  $R_g$   
(Typical Q1 - Q4 Trench IGBT Switching Time vs.  $R_g$   
(with D5 - D6 Clamping Diode)),

$T_J = 125^\circ\text{C}$ ,  $V_{CC} = 325\text{ V}$ ,  $I_C = 150\text{ A}$ ,  $V_{GE} = \pm 15\text{ V}$ ,  $L = 500\ \mu\text{H}$

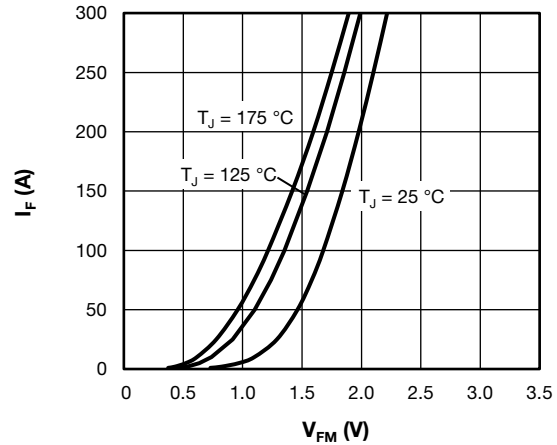

Fig. 11 -  $I_F$  vs.  $V_{FM}$   
(Typical D5 - D6 Clamping Diode Forward Characteristics)

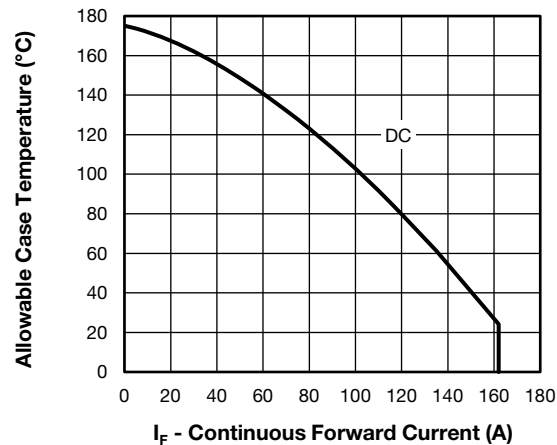

Fig. 12 - Allowable Case Temperature vs. Continuous Forward Current,  
(Maximum D5 - D6 Diode Continuous Forward Current vs.  
Case Temperature)

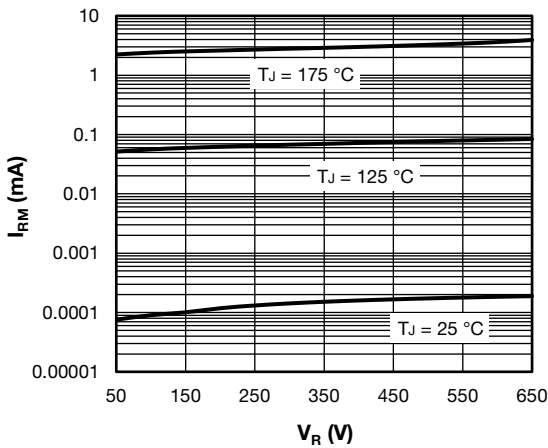

Fig. 13 -  $I_{RM}$  vs.  $V_R$   
(Typical D5 - D6 Clamping Diode Reverse Leakage Current)

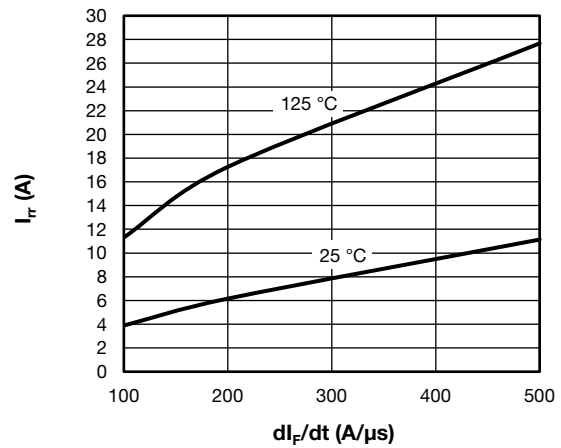

Fig. 15 -  $I_{rr}$  vs.  $di_F/dt$   
(Typical D5 - D6 Clamping Diode Reverse Recovery Current vs.  $di_F/dt$ ),  $V_{rr} = 200\text{ V}$ ,  $I_F = 50\text{ A}$

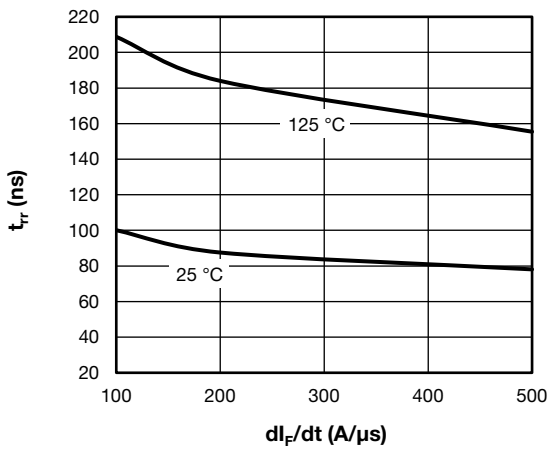

Fig. 14 -  $t_{rr}$  vs.  $di_F/dt$   
(Typical D5 - D6 Clamping Diode Reverse Recovery Time vs.  $di_F/dt$ ),  $V_{rr} = 200\text{ V}$ ,  $I_F = 50\text{ A}$

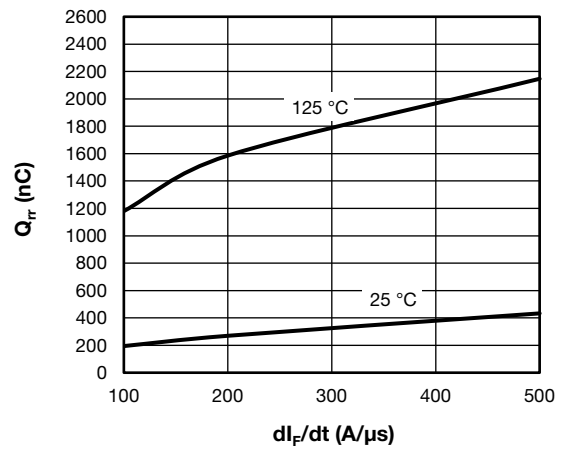

Fig. 16 -  $Q_{rr}$  vs.  $di_F/dt$   
(Typical D5 - D6 Clamping Diode Reverse Recovery Charge vs.  $di_F/dt$ ),  $V_{rr} = 200\text{ V}$ ,  $I_F = 50\text{ A}$

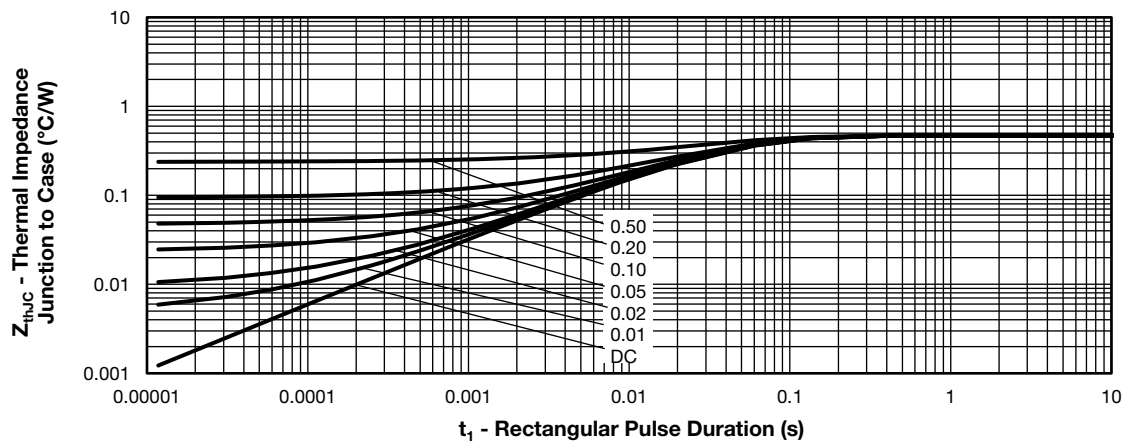

Fig. 17 -  $Z_{thJC}$  vs.  $t_1$  Rectangular Pulse Duration (Maximum Thermal Impedance  $Z_{thJC}$  Characteristics - (D5 - D6 Clamping Diode))

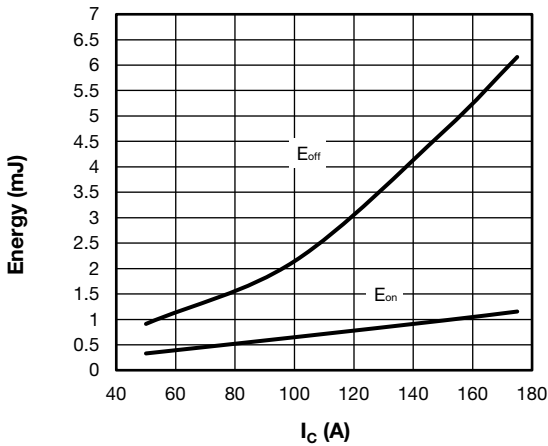

Fig. 18 - Energy Loss vs.  $I_C$   
(Typical Q2 - Q3 Trench IGBT Energy Loss vs.  $I_C$   
(with D2 - D3 Antiparallel Diode)),

$T_J = 125^\circ\text{C}$ ,  $V_{CC} = 325\text{ V}$ ,  $R_g = 4.7\ \Omega$ ,  $V_{GE} = \pm 15\text{ V}$ ,  $L = 500\ \mu\text{H}$

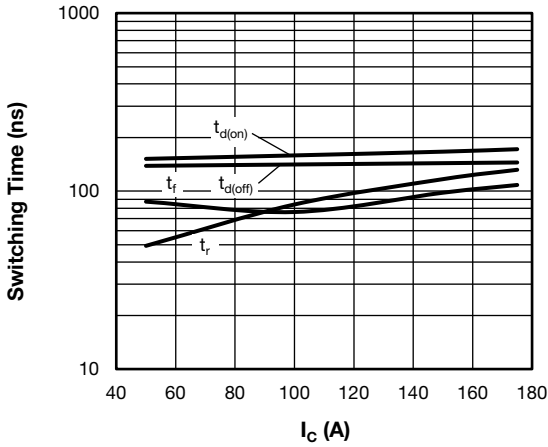

Fig. 19 - Switching Time vs.  $I_C$   
(Typical Q2 - Q3 Trench IGBT Switching Time vs.  $I_C$   
(with D2 - D3 Antiparallel Diode)),

$T_J = 125^\circ\text{C}$ ,  $V_{CC} = 325\text{ V}$ ,  $R_g = 4.7\ \Omega$ ,  $V_{GE} = \pm 15\text{ V}$ ,  $L = 500\ \mu\text{H}$

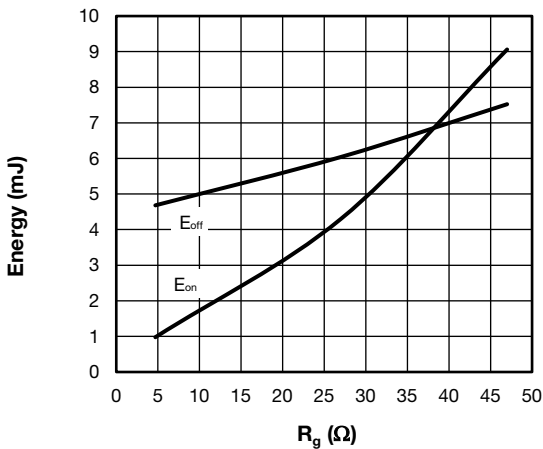

Fig. 20 - Energy Loss vs.  $R_g$   
(Typical Q2 - Q3 Trench IGBT Energy Loss vs.  $R_g$   
(with D2 - D3 Antiparallel Diode)),

$T_J = 125^\circ\text{C}$ ,  $V_{CC} = 325\text{ V}$ ,  $I_C = 150\text{ A}$ ,  $V_{GE} = \pm 15\text{ V}$ ,  $L = 500\ \mu\text{H}$

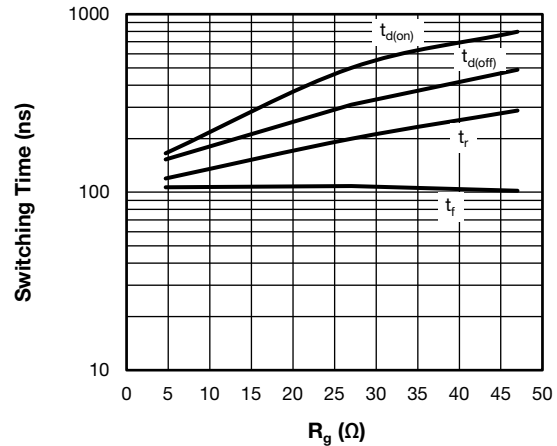

Fig. 21 - Switching Time vs.  $R_g$  (Typical Q2 - Q3 Trench IGBT  
Switching Time vs.  $R_g$  (with D2 - D3 Antiparallel Diode)),

$T_J = 125^\circ\text{C}$ ,  $V_{CC} = 325\text{ V}$ ,  $I_C = 150\text{ A}$ ,  $V_{GE} = \pm 15\text{ V}$ ,  $L = 500\ \mu\text{H}$

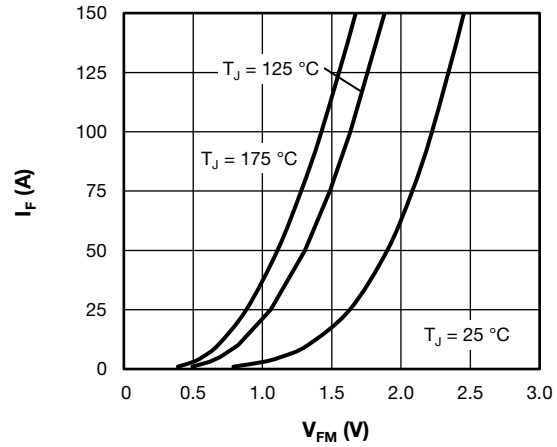

Fig. 22 -  $I_F$  vs.  $V_{FM}$   
(Typical D1 - D2 - D3 - D4 Antiparallel Diode Forward Characteristics)

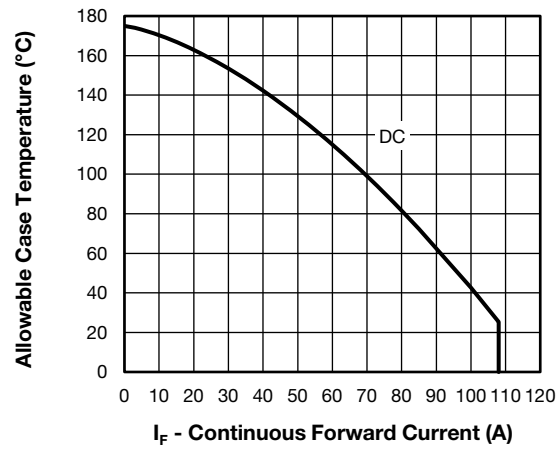

Fig. 23 - Allowable Case Temperature vs. Continuous Forward Current,  
(Maximum D1 - D2 - D3 - D4 Diode Continuous Forward Current vs.  
Case Temperature)



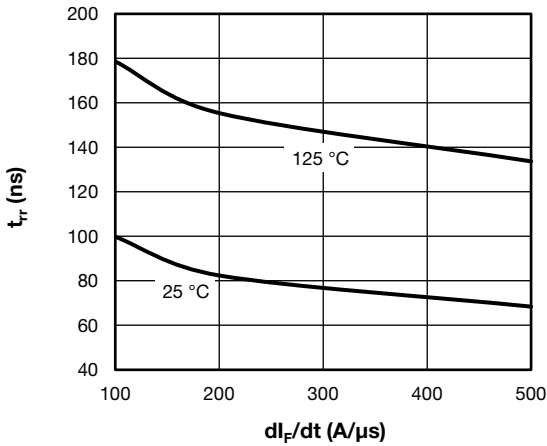

Fig. 24 -  $t_{rr}$  vs.  $di_F/dt$   
(Typical D1 - D2 - D3 - D4 Antiparallel Diode Reverse Recovery Time vs.  $di_F/dt$ ),  $V_{rr} = 200\text{ V}$ ,  $I_F = 50\text{ A}$

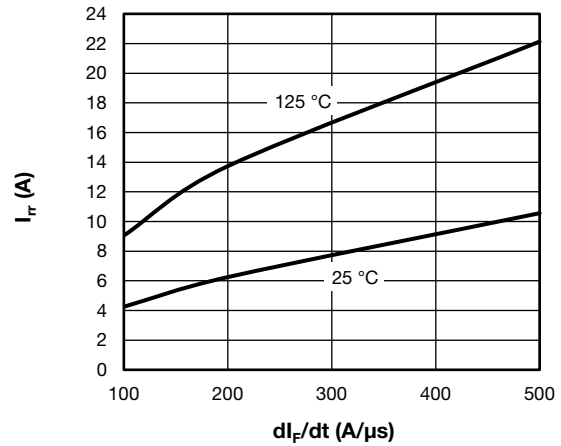

Fig. 25 -  $I_{rr}$  vs.  $di_F/dt$   
(Typical D1 - D2 - D3 - D4 Antiparallel Diode Reverse Recovery Current vs.  $di_F/dt$ ),  $V_{rr} = 200\text{ V}$ ,  $I_F = 50\text{ A}$

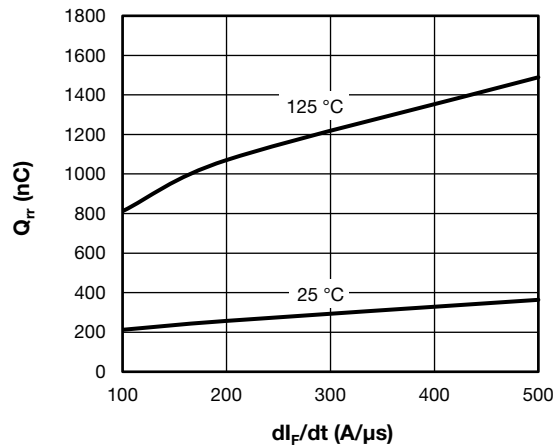

Fig. 26 -  $Q_{rr}$  vs.  $di_F/dt$   
(Typical D1 - D2 - D3 - D4 Antiparallel Diode Reverse Recovery Charge vs.  $di_F/dt$ ),  $V_{rr} = 200\text{ V}$ ,  $I_F = 50\text{ A}$

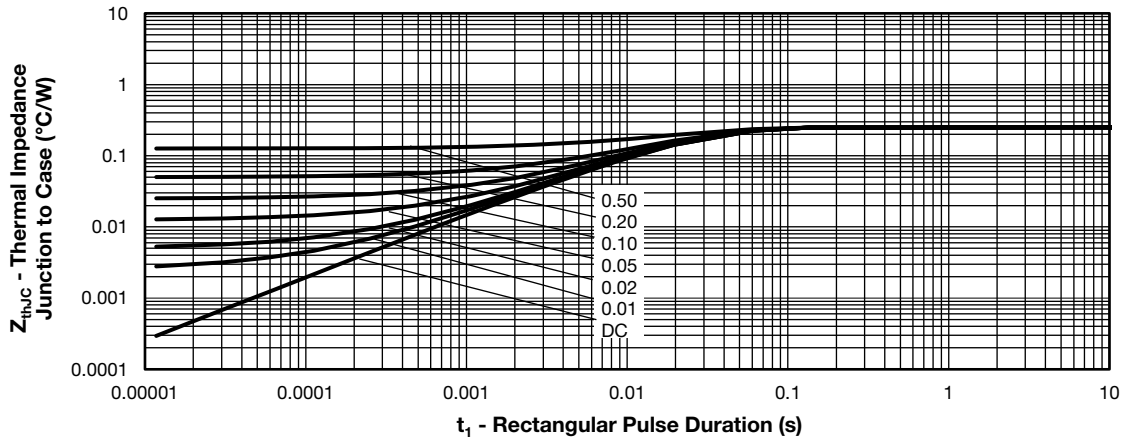

Fig. 27 -  $Z_{thJC}$  vs.  $t_1$  Rectangular Pulse Duration (Maximum Thermal Impedance  $Z_{thJC}$  Characteristics - (Q2 - Q3 Trench IGBT))

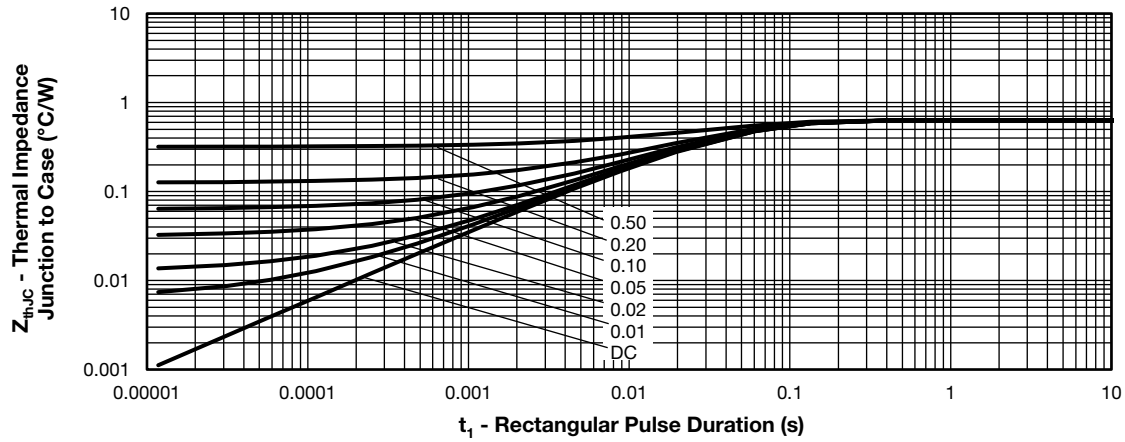

Fig. 28 -  $Z_{thJC}$  vs.  $t_i$  Rectangular Pulse Duration (Maximum Thermal Impedance  $Z_{thJC}$  Characteristics - (D1 - D2 - D3 - D4 Antiparallel Diode))

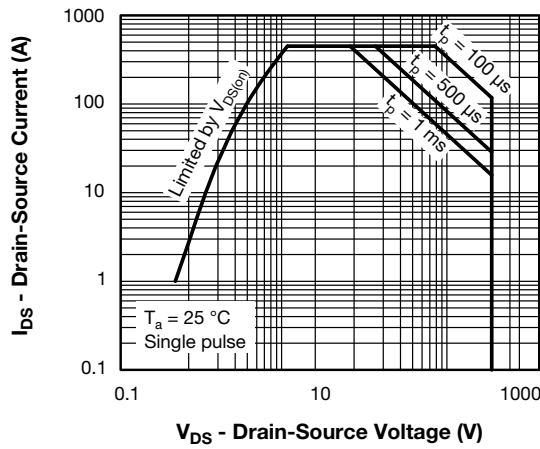

Fig. 29 - SOA

**ORDERING INFORMATION TABLE**

Device code	<b>VS-</b>	<b>ET</b>	<b>F</b>	<b>150</b>	<b>Y</b>	<b>65</b>	<b>N</b>
	①	②	③	④	⑤	⑥	⑦

- 1** - Vishay Semiconductors product
- 2** - Package indicator (ET = EMIPAK-2B)
- 3** - Circuit configuration (F = 3-levels half-bridge inverter stage)
- 4** - Current rating (150 = 150 A)
- 5** - Switch die technology (Y = trench IGBT)
- 6** - Voltage rating (65 = 650 V)
- 7** - Diode die technology (N = ultrafast diode)



CIRCUIT CONFIGURATION

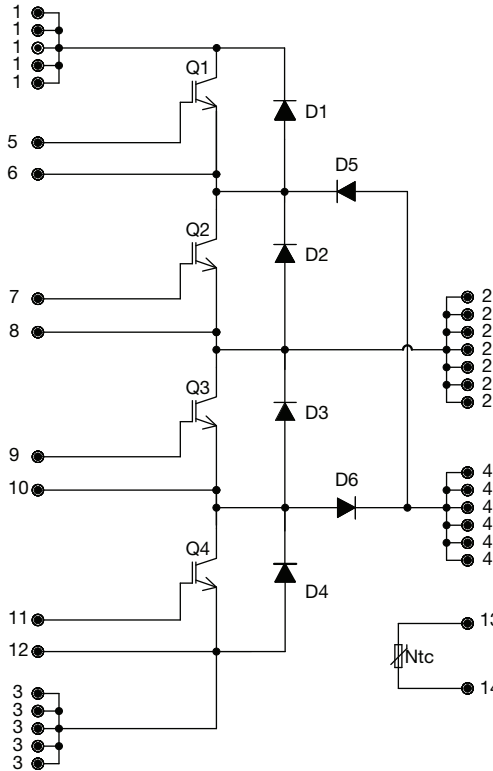

PACKAGE in millimeters

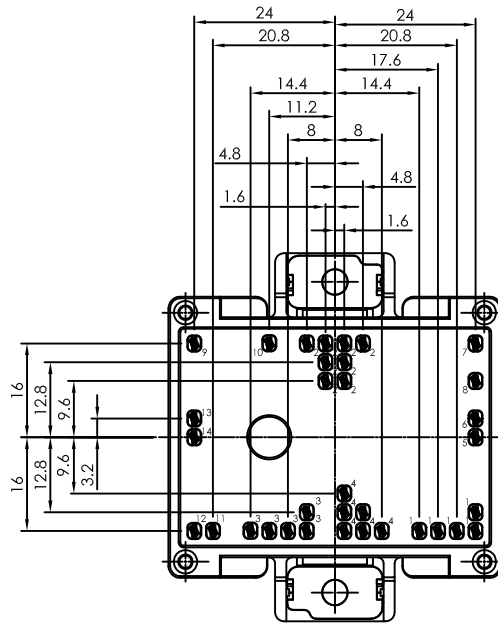

LINKS TO RELATED DOCUMENTS

Dimensions	<a href="http://www.vishay.com/doc?95559">www.vishay.com/doc?95559</a>
------------	--



## EMIPAK-2B PressFit

**DIMENSIONS** in millimeters

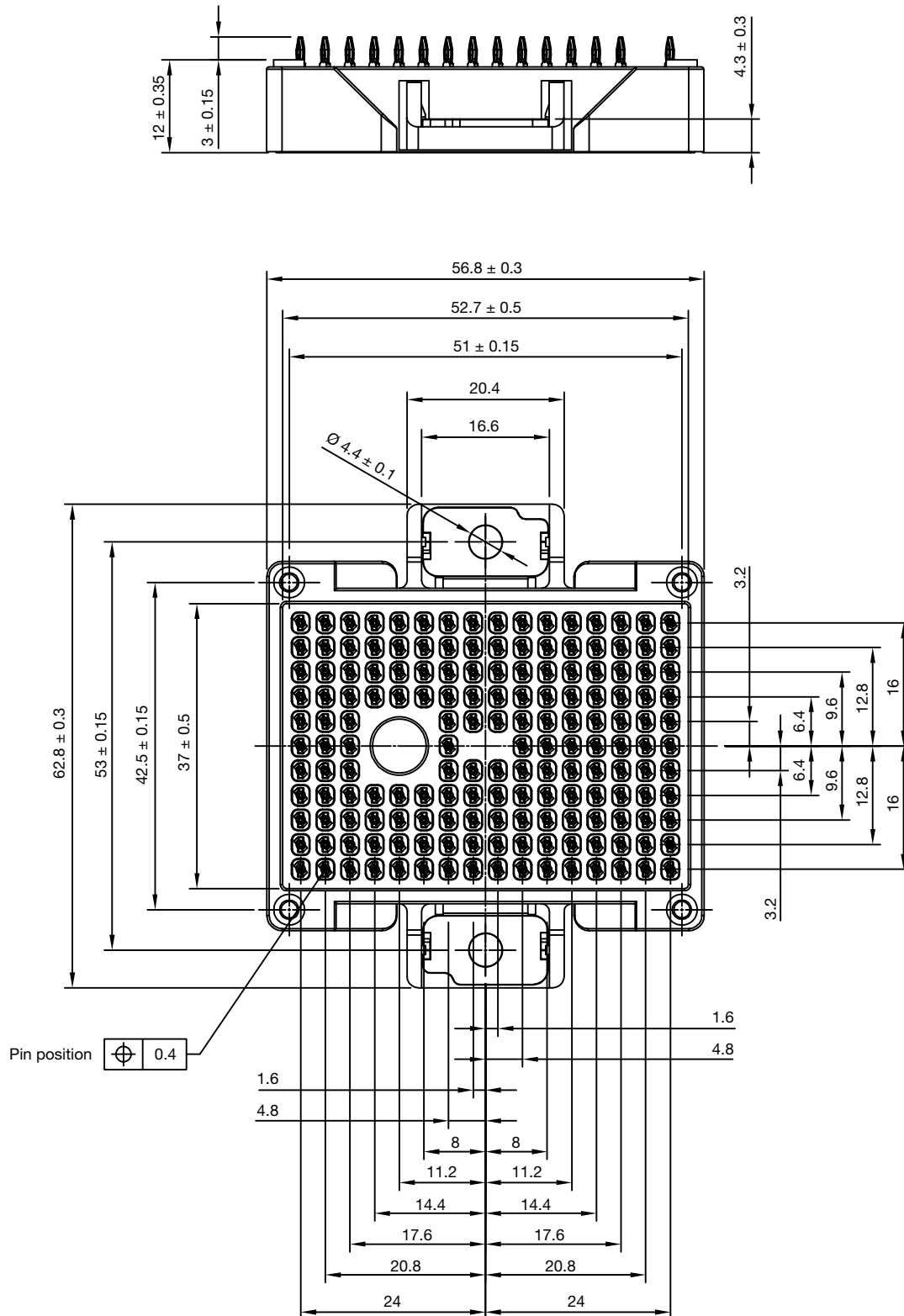



## **Disclaimer**

ALL PRODUCT, PRODUCT SPECIFICATIONS AND DATA ARE SUBJECT TO CHANGE WITHOUT NOTICE TO IMPROVE RELIABILITY, FUNCTION OR DESIGN OR OTHERWISE.

Vishay Intertechnology, Inc., its affiliates, agents, and employees, and all persons acting on its or their behalf (collectively, "Vishay"), disclaim any and all liability for any errors, inaccuracies or incompleteness contained in any datasheet or in any other disclosure relating to any product.

Vishay makes no warranty, representation or guarantee regarding the suitability of the products for any particular purpose or the continuing production of any product. To the maximum extent permitted by applicable law, Vishay disclaims (i) any and all liability arising out of the application or use of any product, (ii) any and all liability, including without limitation special, consequential or incidental damages, and (iii) any and all implied warranties, including warranties of fitness for particular purpose, non-infringement and merchantability.

Statements regarding the suitability of products for certain types of applications are based on Vishay's knowledge of typical requirements that are often placed on Vishay products in generic applications. Such statements are not binding statements about the suitability of products for a particular application. It is the customer's responsibility to validate that a particular product with the properties described in the product specification is suitable for use in a particular application. Parameters provided in datasheets and / or specifications may vary in different applications and performance may vary over time. All operating parameters, including typical parameters, must be validated for each customer application by the customer's technical experts. Product specifications do not expand or otherwise modify Vishay's terms and conditions of purchase, including but not limited to the warranty expressed therein.

Except as expressly indicated in writing, Vishay products are not designed for use in medical, life-saving, or life-sustaining applications or for any other application in which the failure of the Vishay product could result in personal injury or death. Customers using or selling Vishay products not expressly indicated for use in such applications do so at their own risk. Please contact authorized Vishay personnel to obtain written terms and conditions regarding products designed for such applications.

No license, express or implied, by estoppel or otherwise, to any intellectual property rights is granted by this document or by any conduct of Vishay. Product names and markings noted herein may be trademarks of their respective owners.