

IGBT SIP Module (Fast IGBT)



IMS-2

PRODUCT SUMMARY	
OUTPUT CURRENT IN A TYPICAL 5.0 kHz MOTOR DRIVE	
V_{CES}	600 V
I_{RMS} per phase (3.1 kW total) with $T_C = 90\text{ }^\circ\text{C}$	11 A
T_J	125 $^\circ\text{C}$
Supply voltage	360 V_{DC}
Power factor	0.8
Modulation depth See fig. 1	115 %
$V_{CE(on)}$ (typical) at $I_C = 4.8\text{ A}$, 25 $^\circ\text{C}$	1.41 V
Speed	1 kHz to 8 kHz
Package	SIP
Circuit	Three phase inverter

FEATURES

- Fully isolated printed circuit board mount package
- Switching-loss rating includes all “tail” losses
- HEXFRED® soft ultrafast diodes
- Optimized for medium speed, see fig. 1 for current vs. frequency curve
- Designed and qualified for industrial level
- UL approved file E78996
- Material categorization: for definitions of compliance please see www.vishay.com/doc?99912

RoHS
COMPLIANT

DESCRIPTION

The IGBT technology is the key to the advanced line of IMS (Insulated Metal Substrate) power modules. These modules are more efficient than comparable bipolar transistor modules, while at the same time having the simpler gate-drive requirements of the familiar power MOSFET. This superior technology has now been coupled to a state of the art materials system that maximizes power throughput with low thermal resistance. This package is highly suited to motor drive applications and where space is at a premium.

ABSOLUTE MAXIMUM RATINGS				
PARAMETER	SYMBOL	TEST CONDITIONS	MAX.	UNITS
Collector to emitter voltage	V_{CES}		600	V
Continuous collector current, each IGBT	I_C	$T_C = 25\text{ }^\circ\text{C}$	8.8	A
		$T_C = 100\text{ }^\circ\text{C}$	4.8	
Pulsed collector current	I_{CM}	Repetitive rating; $V_{GE} = 20\text{ V}$, pulse width limited by maximum junction temperature. See fig. 20	26	
Clamped inductive load current	I_{LM}	$V_{CC} = 80\%$ (V_{CES}), $V_{GE} = 20\text{ V}$, $L = 10\text{ }\mu\text{H}$, $R_G = 50\text{ }\Omega$ See fig. 19	800	
Diode continuous forward current	I_F	$T_C = 100\text{ }^\circ\text{C}$	3.4	
Diode maximum forward current	I_{FM}		26	
Gate to emitter voltage	V_{GE}		± 20	V
Isolation voltage	V_{ISOL}	Any terminal to case, $t = 1\text{ min}$	2500	V_{RMS}
Maximum power dissipation, each IGBT	P_D	$T_C = 25\text{ }^\circ\text{C}$	23	W
		$T_C = 100\text{ }^\circ\text{C}$	9.1	
Operating junction and storage temperature range	T_J, T_{Stg}		-40 to +150	$^\circ\text{C}$
Soldering temperature		For 10 s	300 (0.063" (1.6 mm) from case)	
Mounting torque		6-32 or M3 screw	5 to 7 (0.55 to 0.8)	lbf · in (N · m)

THERMAL AND MECHANICAL SPECIFICATIONS				
PARAMETER	SYMBOL	TYP.	MAX.	UNITS
Junction to case, each IGBT, one IGBT in conduction	R_{thJC} (IGBT)	-	5.5	$^\circ\text{C/W}$
Junction to case, each diode, one diode in conduction	R_{thJC} (diode)	-	9.0	
Case to sink, flat, greased surface	R_{thCS} (module)	0.1	-	
Weight of module		20 (0.7)	-	g (oz.)



ELECTRICAL SPECIFICATIONS (T _J = 25 °C unless otherwise specified)						
PARAMETER	SYMBOL	TEST CONDITIONS	MIN.	TYP.	MAX.	UNITS
Collector to emitter breakdown voltage	V _{(BR)CES}	V _{GE} = 0 V, I _C = 250 μA Pulse width ≤ 80 μs, duty factor ≤ 0.1 %	600	-	-	V
Temperature coeff. of breakdown voltage	ΔV _{(BR)CES} /ΔT _J	V _{GE} = 0 V, I _C = 1.0 mA	-	0.72	-	V/°C
Collector to emitter saturation voltage	V _{CE(on)}	I _C = 4.8 A	-	1.41	1.7	V
		I _C = 8.8 A	-	1.66	-	
		I _C = 4.8 A, T _J = 150 °C	-	1.42	-	
Gate threshold voltage	V _{GE(th)}	V _{CE} = V _{GE} , I _C = 250 μA	3.0	-	6.0	
Gate to emitter leakage current	I _{GES}	V _{GE} = ± 20 V	-	-	± 100	nA
Temperature coeff. of threshold voltage	ΔV _{GE(th)} /ΔT _J	V _{GE} = 0 V, I _C = 1.0 mA	-	-11	-	mV/°C
Forward transconductance	g _{fe}	V _{CE} = 100 V, I _C = 4.8 A Pulse width 5.0 μs; single shot	2.9	5.0	-	S
Zero gate voltage collector current	I _{CES}	V _{GE} = 0 V, V _{CE} = 600 V	-	-	250	μA
		V _{GE} = 0 V, V _{CE} = 600 V, T _J = 150 °C	-	-	1700	
Diode forward voltage drop	V _{FM}	I _C = 8.0 A	-	1.4	1.7	V
		I _C = 8.0 A, T _J = 150 °C	-	1.3	1.6	

SWITCHING CHARACTERISTICS (T _J = 25 °C unless otherwise specified)								
PARAMETER	SYMBOL	TEST CONDITIONS	MIN.	TYP.	MAX.	UNITS		
Total gate charge (turn on)	Q _g	I _C = 4.8 A V _{CC} = 400 V See fig. 8	-	30	45	nC		
Gate to emitter charge (turn on)	Q _{ge}		-	4.0	6.0			
Gate to collector charge	Q _{gc}		-	13	20			
Turn-on delay time	t _{d(on)}	T _J = 25 °C I _C = 4.8 A, V _{CC} = 480 V V _{GE} = 15 V, R _G = 50 Ω Energy losses include "tail" and diode reverse recovery. See fig. 9, 10, 18	-	49	-	ns		
Rise time	t _r		-	22	-			
Turn-off delay time	t _{d(off)}		-	200	300			
Fall time	t _f		-	214	320			
Turn-on switching loss	E _{on}		-	0.23	-		mJ	
Turn-off switching loss	E _{off}		-	0.33	-			
Total switching loss	E _{ts}	-	0.45	0.70				
Turn-on delay time	t _{d(on)}	T _J = 150 °C, I _C = 4.8 A, V _{CC} = 480 V V _{GE} = 15 V, R _G = 50 Ω Energy losses include "tail" and diode reverse recovery See fig. 10, 11, 18	-	48	-	ns		
Rise time	t _r		-	25	-			
Turn-off delay time	t _{d(off)}		-	435	-			
Fall time	t _f		-	364	-			
Total switching loss	E _{ts}		-	0.93	-		mJ	
Input capacitance	C _{ies}		V _{GE} = 0 V V _{CC} = 30 V	-	340		-	pF
Output capacitance	C _{oes}	See fig. 7		-	63	-		
Reverse transfer capacitance	C _{res}			-	5.9	-		
Diode reverse recovery time	t _{rr}	T _J = 25 °C	See fig. 14	-	37	55	ns	
		T _J = 125 °C		-	55	90		
Diode peak reverse recovery current	I _{rr}	T _J = 25 °C	See fig. 15	-	3.5	50	A	
		T _J = 125 °C		-	4.5	8.0		
Diode reverse recovery charge	Q _{rr}	T _J = 25 °C	See fig. 16	I _F = 8.0 A V _R = 200 V di/dt = 200 A/μs	-	65	138	nC
		T _J = 125 °C			-	124	360	
Diode peak rate of fall of recovery during t _b	dl _{(rec)M} /dt	T _J = 25 °C	See fig. 17		-	240	-	A/μs
		T _J = 125 °C			-	210	-	

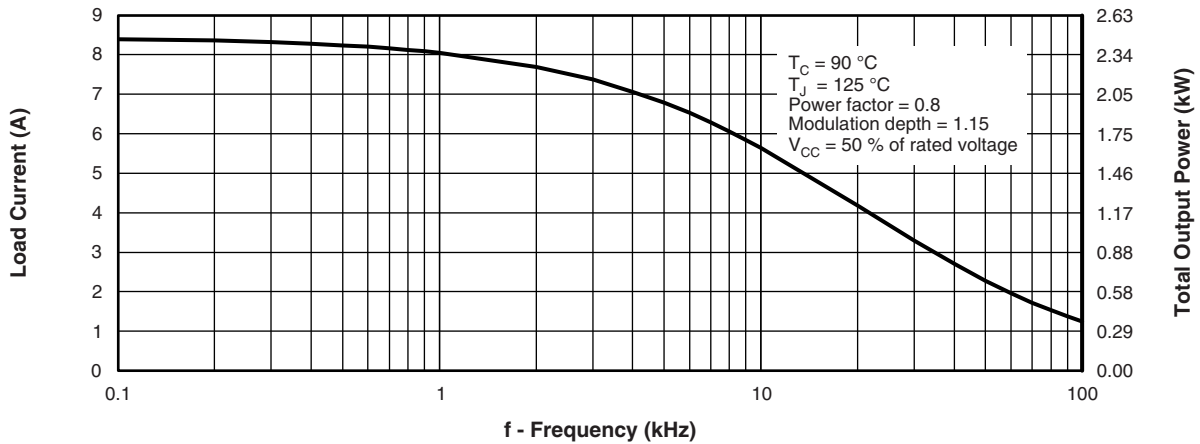

Fig. 1 - Typical Load Current vs. Frequency
(Load Current = I_{RMS} of Fundamental)

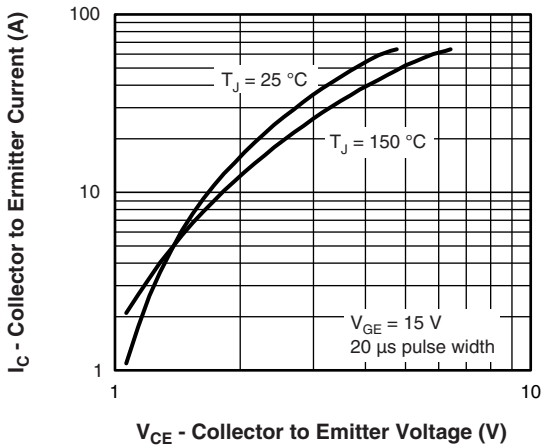

Fig. 2 - Typical Output Characteristics

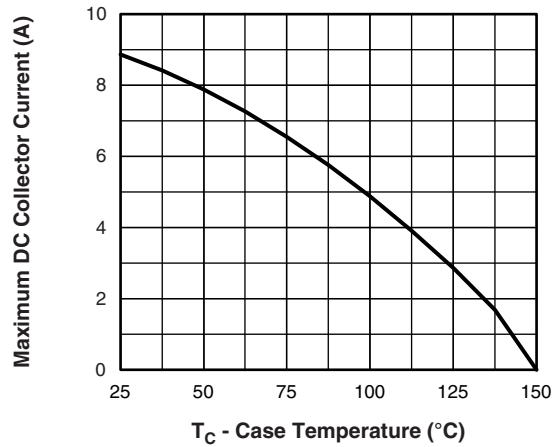

Fig. 4 - Maximum Collector Current vs. Case Temperature

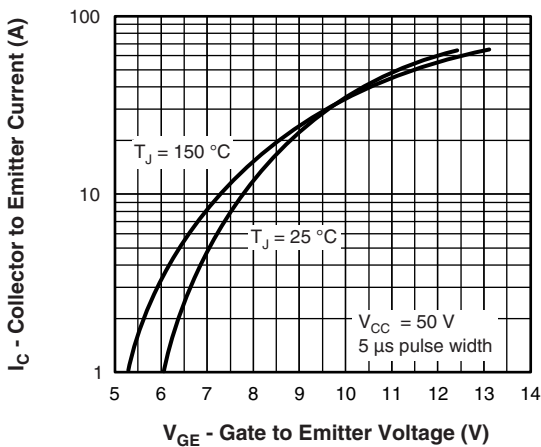

Fig. 3 - Typical Transfer Characteristics

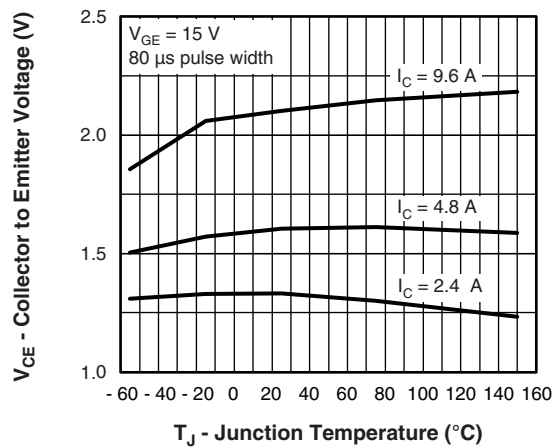

Fig. 5 - Typical Collector to Emitter Voltage vs. Junction Temperature

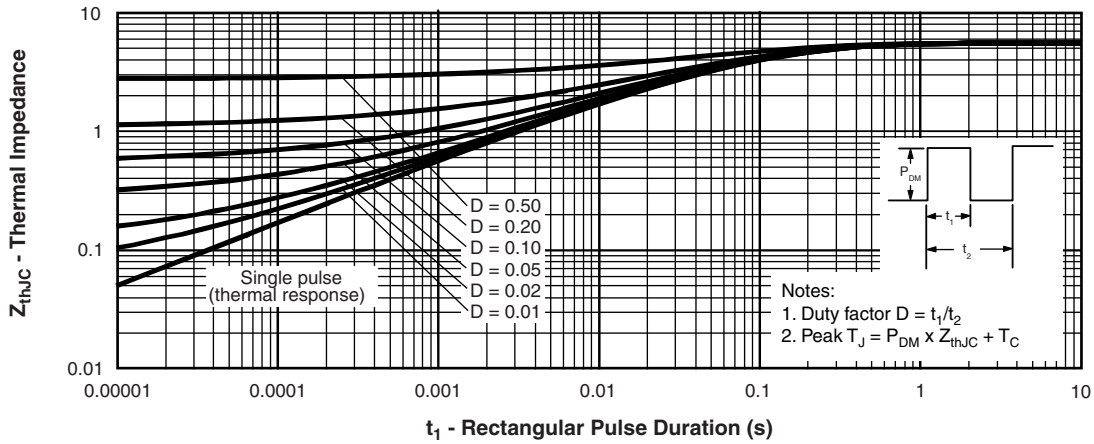

Fig. 6 - Maximum Effective Transient Thermal Impedance, Junction to Case

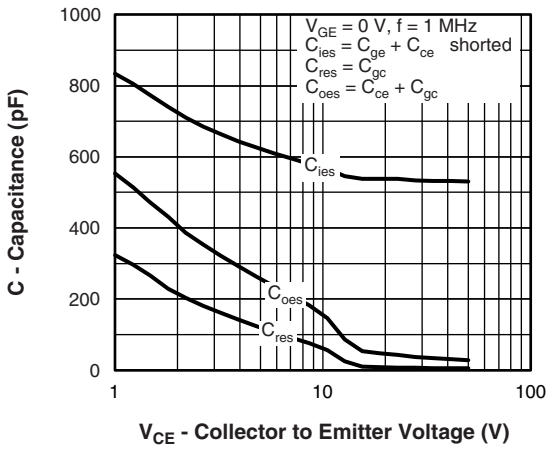

Fig. 7 - Typical Capacitance vs. Collector to Emitter Voltage

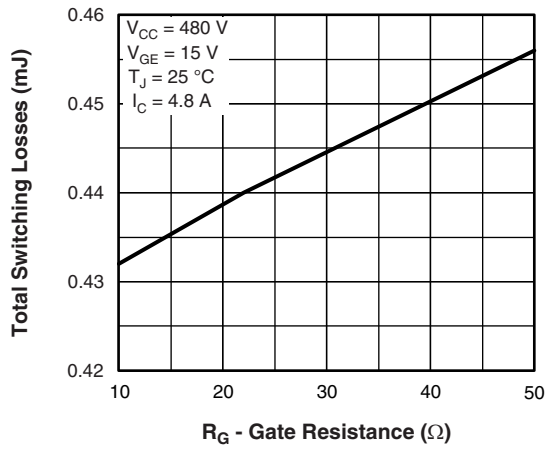

Fig. 9 - Typical Switching Losses vs. Gate Resistance

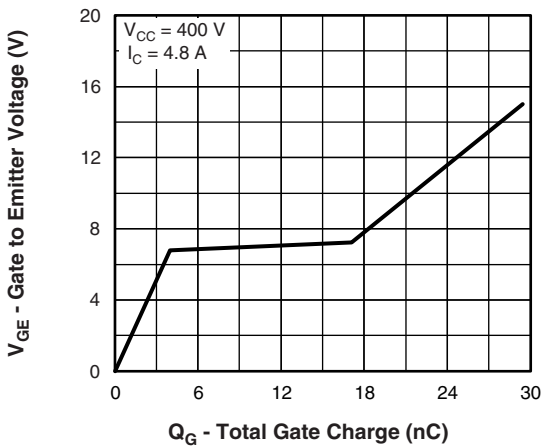

Fig. 8 - Typical Gate Charge vs. Gate to Emitter Voltage

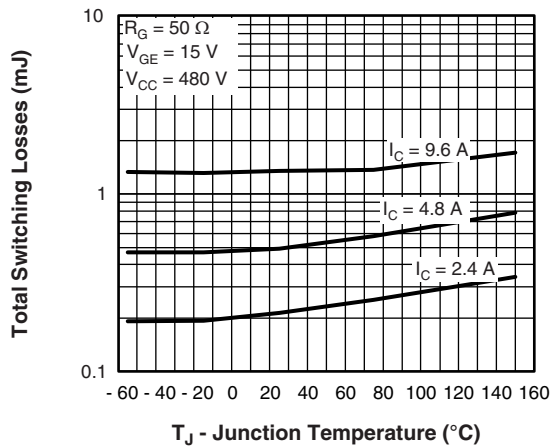

Fig. 10 - Typical Switching Losses vs. Junction Temperature

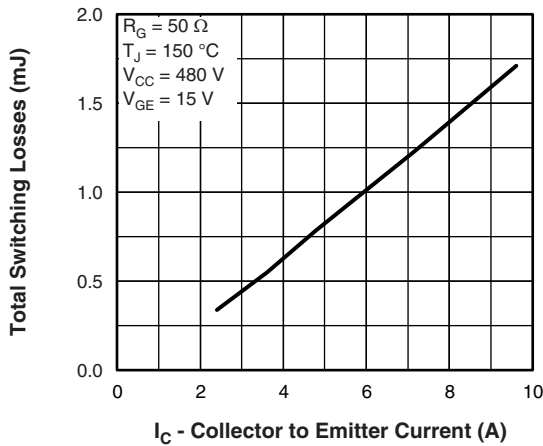

Fig. 11 - Typical Switching Losses vs. Collector to Emitter Current

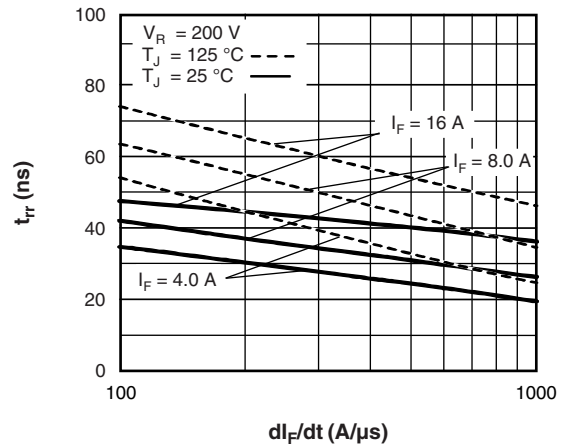

Fig. 14 - Typical Reverse Recovery Time vs. di_F/dt

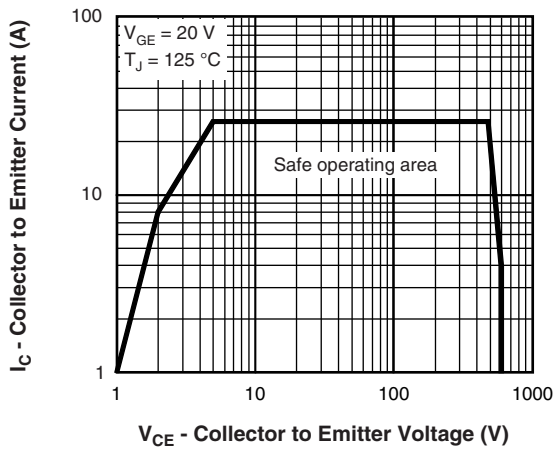

Fig. 12 - Turn-Off SOA

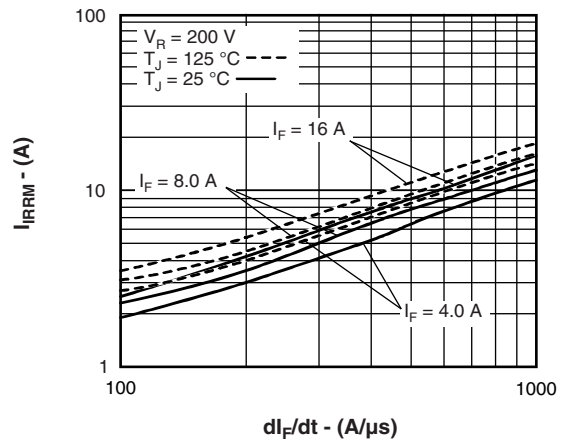

Fig. 15 - Typical Recovery Current vs. di_F/dt

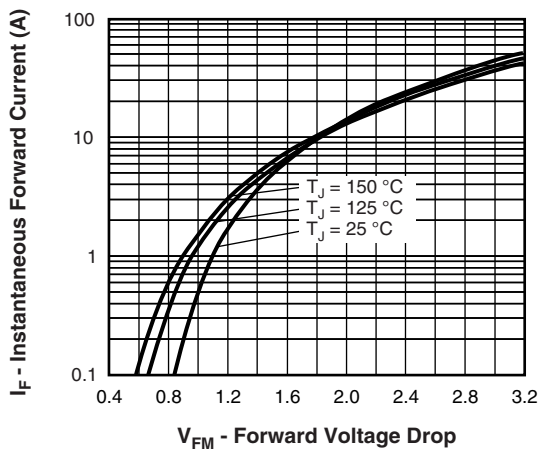

Fig. 13 - Maximum Forward Voltage Drop vs. Instantaneous Forward Current

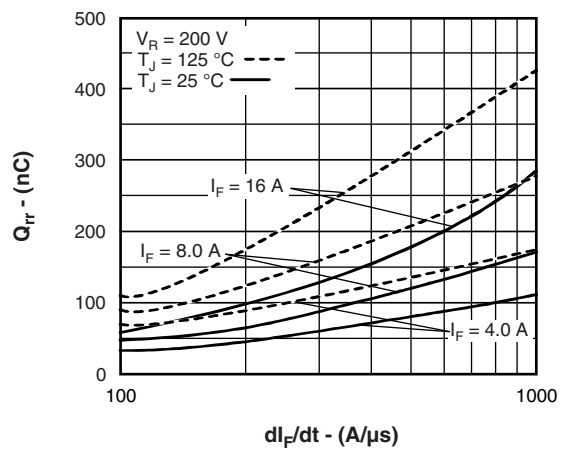

Fig. 16 - Typical Stored Charge vs. di_F/dt

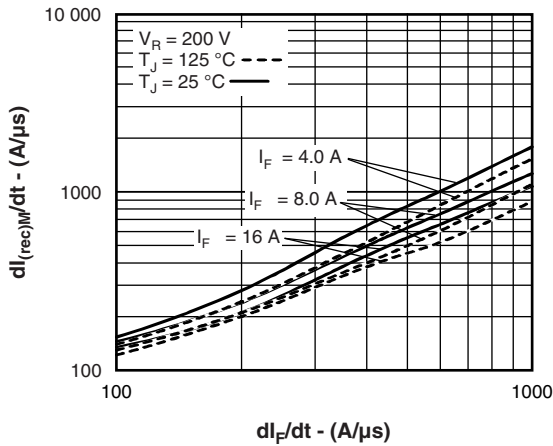

Fig. 17 - Typical $dI_{(REC)M}/dt$ vs dI_F/dt

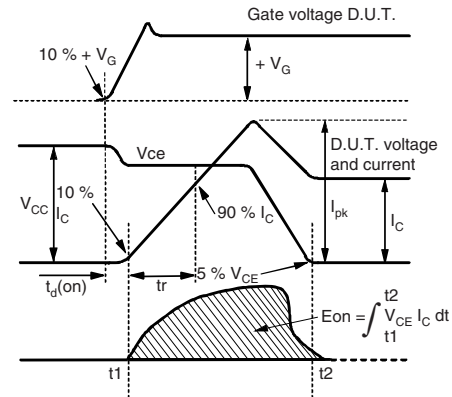

Fig. 18c - Test Waveforms of Circuit of Fig. 18a, Defining E_{on} , $t_{d(on)}$, t_r

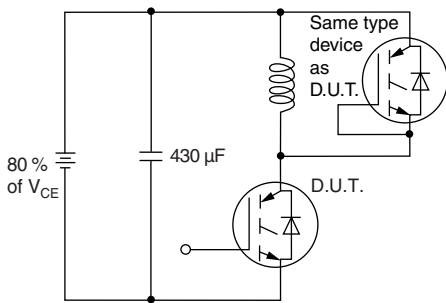

Fig. 18a - Test Circuit for Measurement of I_{LM} , E_{on} , $E_{off(diode)}$, t_{rr} , Q_{rr} , I_{rr} , $t_{d(on)}$, t_r , $t_{d(off)}$, t_f

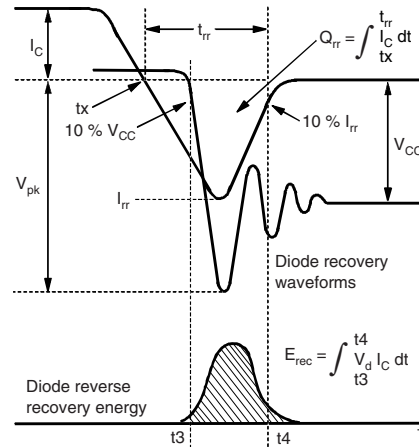

Fig. 18d - Test Waveforms of Circuit of Fig. 18a, Defining E_{rec} , t_{rr} , Q_{rr} , I_{rr}

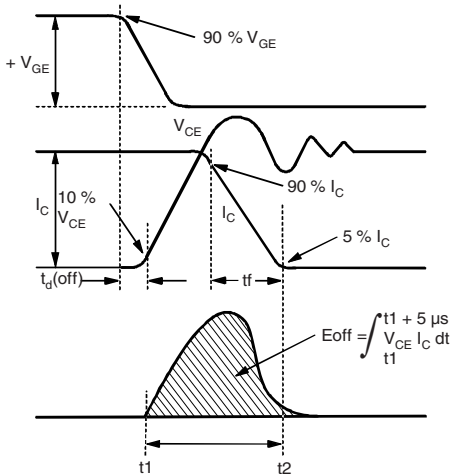

Fig. 18b - Test Waveforms of Circuit of Fig. 18a, Defining E_{off} , $t_{d(off)}$, t_f

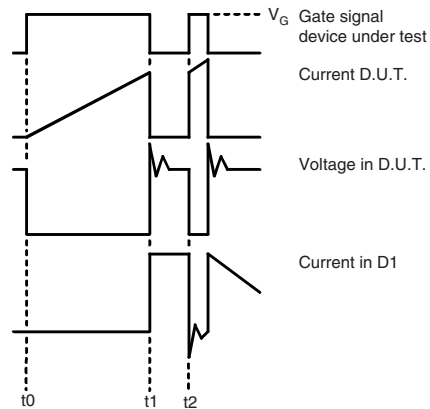

Fig. 18e - Macro Waveforms for Figure 18a's Test Circuit

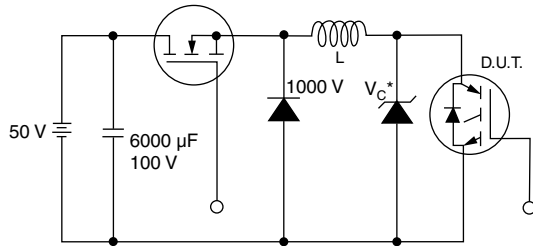

Fig. 19 - Clamped Inductive Load Test Circuit

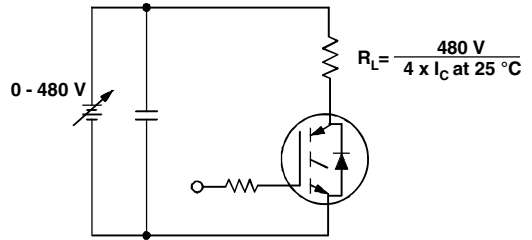
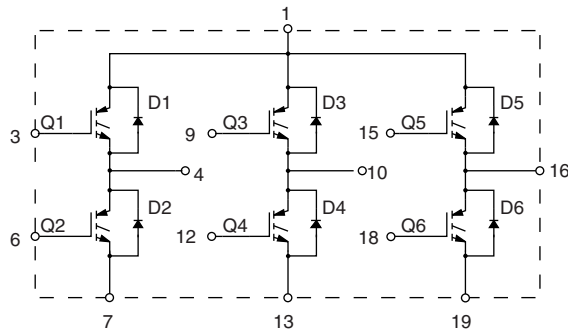

Fig. 20 - Pulsed Collector Current Test Circuit

CIRCUIT CONFIGURATION

LINKS TO RELATED DOCUMENTS

Dimensions	www.vishay.com/doc?95066
------------	--

IMS-2 (SIP)

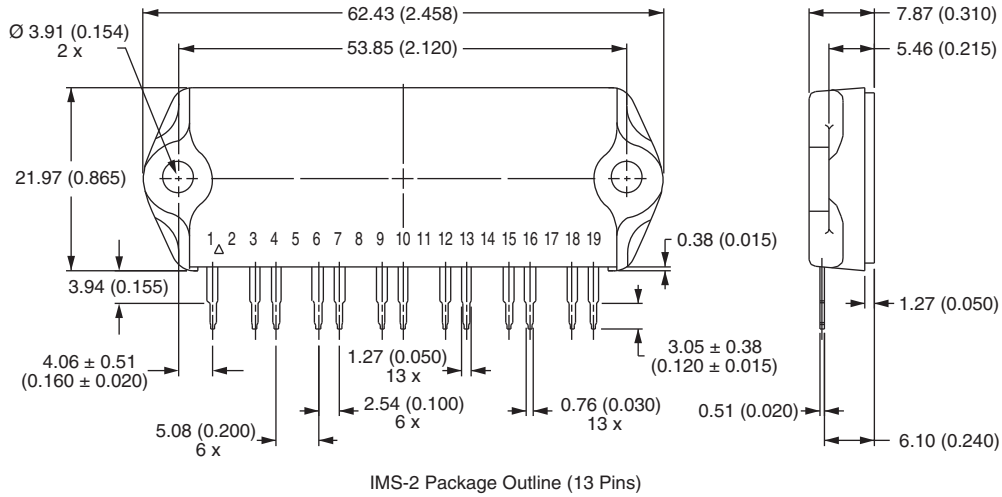
DIMENSIONS in millimeters (inches)



Notes

- (1) Tolerance unless otherwise specified ± 0.254 mm (0.010")
- (2) Controlling dimension: inch
- (3) Terminal numbers are shown for reference only



Disclaimer

ALL PRODUCT, PRODUCT SPECIFICATIONS AND DATA ARE SUBJECT TO CHANGE WITHOUT NOTICE TO IMPROVE RELIABILITY, FUNCTION OR DESIGN OR OTHERWISE.

Vishay Intertechnology, Inc., its affiliates, agents, and employees, and all persons acting on its or their behalf (collectively, "Vishay"), disclaim any and all liability for any errors, inaccuracies or incompleteness contained in any datasheet or in any other disclosure relating to any product.

Vishay makes no warranty, representation or guarantee regarding the suitability of the products for any particular purpose or the continuing production of any product. To the maximum extent permitted by applicable law, Vishay disclaims (i) any and all liability arising out of the application or use of any product, (ii) any and all liability, including without limitation special, consequential or incidental damages, and (iii) any and all implied warranties, including warranties of fitness for particular purpose, non-infringement and merchantability.

Statements regarding the suitability of products for certain types of applications are based on Vishay's knowledge of typical requirements that are often placed on Vishay products in generic applications. Such statements are not binding statements about the suitability of products for a particular application. It is the customer's responsibility to validate that a particular product with the properties described in the product specification is suitable for use in a particular application. Parameters provided in datasheets and / or specifications may vary in different applications and performance may vary over time. All operating parameters, including typical parameters, must be validated for each customer application by the customer's technical experts. Product specifications do not expand or otherwise modify Vishay's terms and conditions of purchase, including but not limited to the warranty expressed therein.

Except as expressly indicated in writing, Vishay products are not designed for use in medical, life-saving, or life-sustaining applications or for any other application in which the failure of the Vishay product could result in personal injury or death. Customers using or selling Vishay products not expressly indicated for use in such applications do so at their own risk. Please contact authorized Vishay personnel to obtain written terms and conditions regarding products designed for such applications.

No license, express or implied, by estoppel or otherwise, to any intellectual property rights is granted by this document or by any conduct of Vishay. Product names and markings noted herein may be trademarks of their respective owners.