

ALL TOLERANCES = ± 0.004 [± 0.10]
UNLESS OTHERWISE INDICATED

BACK SHELL KIT INCLUDES:

- 2 - BACK SHELL HALVES
- 2 - 4-40 MATING SCREWS
- 2 - SADDLE WASHERS
- 2 - HOUSING SCREWS
- 2 - HOUSING NUTS
- 1 - GROMMET TREE - VARIOUS SIZES
(NON-CONDUCTIVE GROMMETS)

MATERIAL: DIE-CAST ZINC ALLOY
PLATING: NICKEL
OPERATING TEMPERATURE: -45°C TO + 120°C

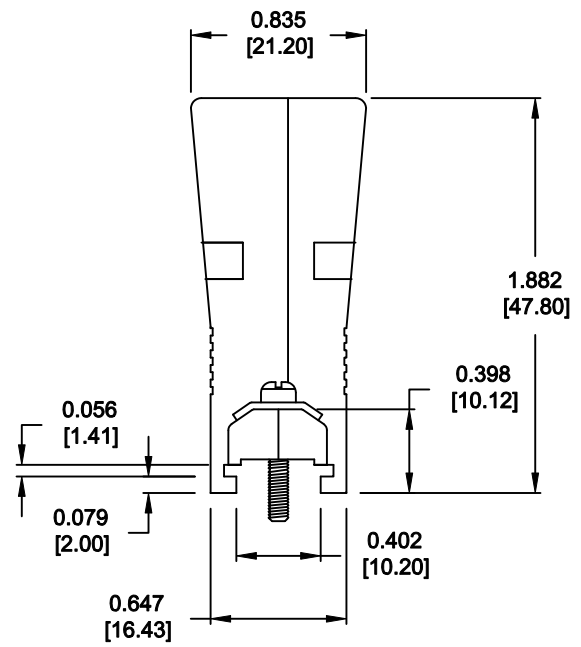
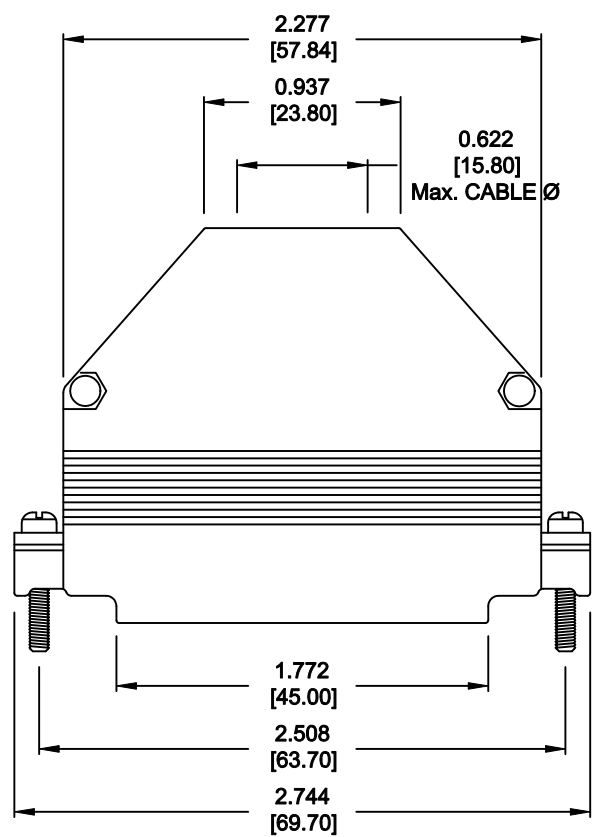

979-037-030 R 12 1

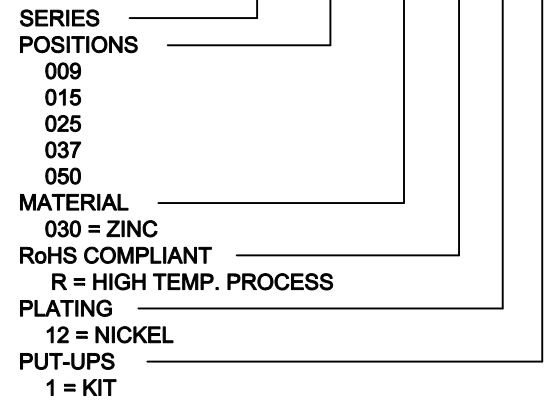

DO NOT SCALE FROM DRAWING

RoHS COMPLIANT

	THESE DRAWINGS AND SPECIFICATIONS ARE THE PROPERTY OF NorComp AND SHALL NOT BE REPRODUCED, COPIED OR USED AS THE BASIS FOR THE MANUFACTURE OF SALE OF APPARATUS WITHOUT WRITTEN PERMISSION.		DRAWN: C. SMITH	DATE: 03-18-10
			CHECKED:	DATE:
<h1>NorComp</h1>		SCALE: 1 : 1	SHEET 1 OF 1	REV 2
		DWG NO. 979-037-030R121		

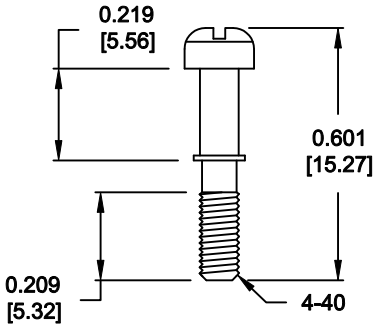

MATING SCREW

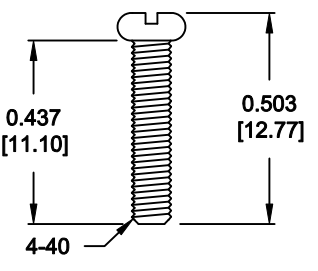

HOUSING SCREW

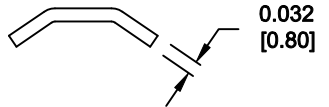

SADDLE WASHER

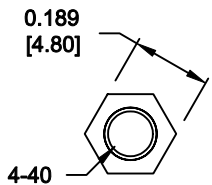
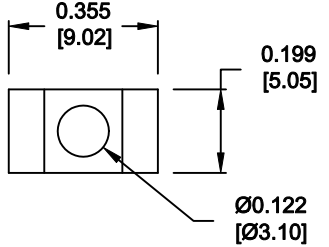

HOUSING NUT

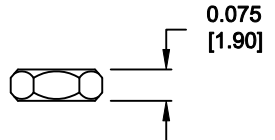

ALL HARDWARE:
 MATERIAL = BRASS
 PLATING = NICKEL
 TOLERANCE = ±0.002 [±0.05]
 SCALE = 2 : 1

RoHS COMPLIANT

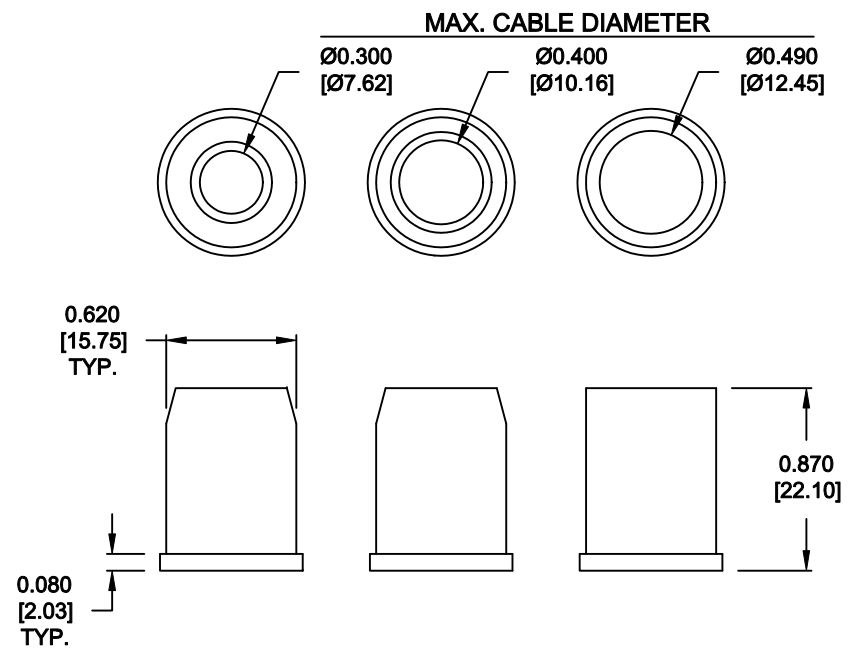

MATERIAL: NON CONDUCTIVE PVC - BLACK
 TOLERANCE = ±0.010 [±0.25]
 SCALE = 1 : 1

DO NOT SCALE FROM DRAWING

	THESE DRAWINGS AND SPECIFICATIONS ARE THE PROPERTY OF NorComp AND SHALL NOT BE REPRODUCED, COPIED OR USED AS THE BASIS FOR THE MANUFACTURE OF SALE OF APPARATUS WITHOUT WRITTEN PERMISSION.		DRAWN: C. SMITH	DATE: 04-20-10
			CHECKED:	DATE:
<h1>NorComp</h1>		SCALE: AS SHOWN	SHEET 2 OF 2	REV 2
		DWG NO. 979-037-030R121		