

SIOV metal oxide varistors

Leaded varistors, EnergetiQ series

Series/Type: B722*
Date: May 2017

© EPCOS AG 2017. Reproduction, publication and dissemination of this publication, enclosures hereto and the information contained therein without EPCOS' prior express consent is prohibited.

EPCOS AG is a TDK Group Company.

EnergetiQ series
Construction

- Square varistor element, leaded
- Coating: epoxy resin, flame-retardant to UL 94 V-0

Features

- High-EnergetiQ series Q14/Q20
- Maximum load capacity at minimum component height
- Very high surge current ratings up to 15 kA
- All types duty cycle @ 6 kV/ 3 kA → 10 pulses, according to IEC 60950-1 Annex Q; IEC 61051-2
- All types I_{nom} @ 3 kA (Q14), $I_{nom} = 5$ kA (Q20) → 15 impulses according to UL 1449, 3rd edition surge current generator (8/20 μ s), Type 2 listed
- PSpice models

Approvals

- UL
- CSA
- VDE
- IEC

Delivery mode

- Bulk (standard), taped versions on reel or in Ammo pack upon request.
- For further details refer chapter "Taping, packaging and lead configuration" for leaded varistors.

General technical data

Climatic category	to IEC 60068-1	40/105/56	
Operating temperature	to IEC 61051	-40 ... +105	°C
Storage temperature		-40 ... +125	°C
Electric strength	to IEC 61051	≥ 2.5	kV _{RMS}
Insulation resistance	to IEC 61051	≥ 100	M Ω
Response time		< 25	ns

Electrical specifications and ordering codes
Maximum ratings ($T_A = 105\text{ °C}$)

Ordering code	Type (untaped) SIOV-	V_{RMS}	V_{DC}	i_{max} (8/20 μ s)	W_{max} (2 ms)	P_{max}
		V	V	A	J	W
B72214Q0131K101	Q14K130	130	170	8000	75	0.80
B72220Q0131K101	Q20K130	130	170	15000	100	1.20
B72214Q0141K101	Q14K140	140	180	8000	80	0.80
B72220Q0141K101	Q20K140	140	180	15000	110	1.20
B72214Q0151K101	Q14K150	150	200	8000	85	0.80
B72220Q0151K101	Q20K150	150	200	15000	120	1.20
B72214Q0171K101	Q14K175	175	225	8000	100	0.80
B72220Q0171K101	Q20K175	175	225	15000	135	1.20
B72214Q0211K101	Q14K210	210	270	8000	115	0.80
B72220Q0211K101	Q20K210	210	270	15000	165	1.20
B72214Q0231K101	Q14K230	230	300	8000	130	0.80
B72220Q0231K101	Q20K230	230	300	15000	180	1.20
B72214Q0251K101	Q14K250	250	320	8000	140	0.80
B72220Q0251K101	Q20K250	250	320	15000	195	1.20
B72214Q0271K101	Q14K275	275	350	8000	150	0.80
B72220Q0271K101	Q20K275	275	350	15000	215	1.20
B72214Q0301K101	Q14K300	300	385	8000	175	0.80
B72220Q0301K101	Q20K300	300	385	15000	235	1.20
B72214Q0321K101	Q14K320	320	420	8000	185	0.80
B72220Q0321K101	Q20K320	320	420	15000	255	1.20
B72214Q0351K101	Q14K350	350	460	8000	200	0.80
B72220Q0351K101	Q20K350	350	460	15000	280	1.20
B72214Q0381K101	Q14K385	385	505	8000	225	0.80
B72220Q0381K101	Q20K385	385	505	15000	315	1.20
B72214Q0421K101	Q14K420	420	560	8000	245	0.80
B72220Q0421K101	Q20K420	420	560	15000	340	1.20
B72214Q0461K101	Q14K460	460	615	8000	270	0.80
B72220Q0461K101	Q20K460	460	615	15000	380	1.20

Characteristics (T_A = 25 °C)

Ordering code	V _v (1 mA) V	ΔV _v (1 mA) %	V _{c,max} (i _c) V	i _c A	C _{typ} (1 kHz) pF
	B72214Q0131K101	205	±10	340	65
B72220Q0131K101	205	±10	340	130	2400
B72214Q0141K101	220	±10	360	65	1200
B72220Q0141K101	220	±10	360	130	2200
B72214Q0151K101	240	±10	395	65	1100
B72220Q0151K101	240	±10	395	130	2000
B72214Q0171K101	270	±10	455	65	1000
B72220Q0171K101	270	±10	455	130	1800
B72214Q0211K101	330	±10	550	65	750
B72220Q0211K101	330	±10	550	130	1500
B72214Q0231K101	360	±10	595	65	700
B72220Q0231K101	360	±10	595	130	1350
B72214Q0251K101	390	±10	650	65	650
B72220Q0251K101	390	±10	650	130	1250
B72214Q0271K101	430	±10	710	65	600
B72220Q0271K101	430	±10	710	130	1150
B72214Q0301K101	470	±10	775	65	550
B72220Q0301K101	470	±10	775	130	1050
B72214Q0321K101	510	±10	840	65	500
B72220Q0321K101	510	±10	840	130	950
B72214Q0351K101	560	±10	910	65	450
B72220Q0351K101	560	±10	910	130	870
B72214Q0381K101	620	±10	1025	65	400
B72220Q0381K101	620	±10	1025	130	780
B72214Q0421K101	680	±10	1120	65	360
B72220Q0421K101	680	±10	1120	130	710
B72214Q0461K101	750	±10	1240	65	330
B72220Q0461K101	750	±10	1240	130	650

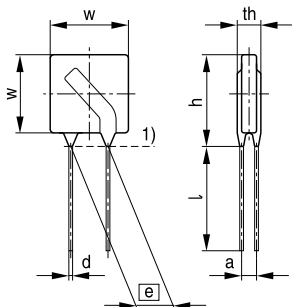
Dimensional drawings

1) Seating plane to IEC 60717

VAR0393-TE

Weight

Nominal diameter mm	V_{RMS} V	Weight g
14	130 ... 460	2.4 ... 4.4
20	130 ... 460	4.1 ... 8.2

The weight of varistors in between these voltage classes can be interpolated.

Dimensions

Ordering code	[e] ±1 mm	a ±1 mm	w_{max} mm	th_{max} mm	h_{max} mm	l_{min} mm	d ±0.05 mm
B72214Q0131K101	10.0	1.9	16.5	5.0	19.5	25.0	1.0
B72220Q0131K101	10.0	1.9	22.5	5.0	27.0	25.0	1.0
B72214Q0141K101	10.0	2.0	16.5	5.1	19.5	25.0	1.0
B72220Q0141K101	10.0	2.0	22.5	5.1	27.0	25.0	1.0
B72214Q0151K101	10.0	2.1	16.5	5.2	19.5	25.0	1.0
B72220Q0151K101	10.0	2.1	22.5	5.2	27.0	25.0	1.0
B72214Q0171K101	10.0	2.2	16.5	5.3	19.5	25.0	1.0
B72220Q0171K101	10.0	2.2	22.5	5.3	27.0	25.0	1.0
B72214Q0211K101	10.0	2.2	16.5	5.4	19.5	25.0	1.0
B72220Q0211K101	10.0	2.2	22.5	5.4	27.0	25.0	1.0
B72214Q0231K101	10.0	2.3	16.5	5.5	19.5	25.0	1.0
B72220Q0231K101	10.0	2.3	22.5	5.5	27.0	25.0	1.0
B72214Q0251K101	10.0	2.4	16.5	5.7	19.5	25.0	1.0
B72220Q0251K101	10.0	2.4	22.5	5.7	27.0	25.0	1.0
B72214Q0271K101	10.0	2.6	16.5	5.8	19.5	25.0	1.0
B72220Q0271K101	10.0	2.6	22.5	5.8	27.0	25.0	1.0
B72214Q0301K101	10.0	2.8	16.5	6.1	19.5	25.0	1.0
B72220Q0301K101	10.0	2.8	22.5	6.1	27.0	25.0	1.0
B72214Q0321K101	10.0	2.9	16.5	6.3	19.5	25.0	1.0
B72220Q0321K101	10.0	2.9	22.5	6.3	27.0	25.0	1.0
B72214Q0351K101	10.0	3.6	16.5	7.3	19.5	25.0	1.0
B72220Q0351K101	10.0	3.6	22.5	7.3	27.0	25.0	1.0
B72214Q0381K101	10.0	3.9	16.5	7.6	19.5	25.0	1.0
B72220Q0381K101	10.0	3.9	22.5	7.6	27.0	25.0	1.0
B72214Q0421K101	10.0	4.2	16.5	7.9	19.5	25.0	1.0
B72220Q0421K101	10.0	4.2	22.5	7.9	27.0	25.0	1.0
B72214Q0461K101	10.0	4.5	16.5	8.2	19.5	25.0	1.0
B72220Q0461K101	10.0	4.5	22.5	8.2	27.0	25.0	1.0

Reliability data

Test	Test methods/conditions	Requirement
Varistor voltage	The voltage between two terminals with the specified measuring current applied is called V_V (1 mA _{DC} @ 0.2 ... 2 s).	To meet the specified value
Clamping voltage	The maximum voltage between two terminals with the specified standard impulse current (8/20 μ s) applied.	To meet the specified value
Endurance at upper category temperature	1000 h at UCT After having continuously applied the maximum allowable AC voltage at UCT ± 2 °C for 1000 h, the specimen shall be stored at room temperature and normal humidity for 1 to 2 h. Thereafter, the change of V_V shall be measured.	$ \Delta V/V$ (1 mA) $\leq 10\%$
Surge current derating, 8/20 μ s	10 surge currents (8/20 μ s), unipolar, interval 30 s, amplitude corresponding to derating curve for 10 impulses at 20 μ s	$ \Delta V/V$ (1 mA) $\leq 10\%$ (measured in direction of surge current) No visible damage
Surge current derating, 2 ms	10 surge currents (2 ms), unipolar, interval 120 s, amplitude corresponding to derating curve for 10 impulses at 2 ms	$ \Delta V/V$ (1 mA) $\leq 10\%$ (measured in direction of surge current) No visible damage
Electric strength	IEC 61051-1, test 4.9.2 Metal balls method, 2500 V _{RMS} , 60 s The varistor is placed in a container holding 1.6 \pm 0.2 mm diameter metal balls such that only the terminations of the varistor are protruding. The specified voltage shall be applied between both terminals of the specimen connected together and the electrode inserted between the metal balls.	No breakdown



Test	Test methods/conditions	Requirement
Climatic sequence	<p>The specimen shall be subjected to:</p> <p>a) dry heat at UCT, 16 h, IEC 60068-2-2, test Ba</p> <p>b) damp heat, 1st cycle: 55 °C, 93% r. H., 24 h, IEC 60068-2-30, test Db</p> <p>c) cold, LCT, 2 h, IEC 60068-2-1, test Aa</p> <p>d) damp heat, additional 5 cycles: 55 °C/25 °C, 93% r. H., 24 h/cycle, IEC 60068-2-30, test Db.</p> <p>Then the specimen shall be stored at room temperature and normal humidity for 1 to 2 h.</p> <p>Thereafter, the change of V_V shall be measured. Thereafter, insulation resistance R_{ins} shall be measured at $V = 500$ V.</p>	$ \Delta V/V (1 \text{ mA}) \leq 10\%$ $R_{ins} \geq 100 \text{ M}\Omega$
Rapid change of temperature	IEC 60068-2-14, test Na, LCT/UCT, dwell time 30 min, 5 cycles	$ \Delta V/V (1 \text{ mA}) \leq 5\%$ No visible damage
Damp heat, steady state	IEC 60068-2-78, test Ca The specimen shall be subjected to 40 ± 2 °C, 90 to 95% r. H. for 56 days without load / with 10% of the maximum continuous DC operating voltage V_{DC} . Then stored at room temperature and normal humidity for 1 to 2 h. Thereafter, the change of V_V shall be measured. Thereafter, insulation resistance R_{ins} shall be measured at $V = 500$ V (insulated varistors only).	$ \Delta V/V (1 \text{ mA}) \leq 10\%$ $R_{ins} \geq 100 \text{ M}\Omega$

Leaded varistors
B722*
EnergetiQ series

Test	Test methods/conditions	Requirement
Solderability	IEC 60068-2-20, test Ta, method 1 with modified conditions for lead-free solder alloys: 245 °C, 3 s: After dipping the terminals to a depth of approximately 3 mm from the body in a soldering bath of 245 °C for 3 s, the terminals shall be visually examined.	The inspection shall be carried out under adequate light with normal eyesight or with the assistance of a magnifier capable of giving a magnification of 4 to 10 times. The dipped surface shall be covered with a smooth and bright solder coating with no more than small amounts of scattered imperfections such as pinholes or un-wetted or de-wetted areas. These imperfections shall not be concentrated in one area.
Resistance to soldering heat	IEC 60068-2-20, test Tb, method 1A, 260 °C, 10 s: Each lead shall be dipped into a solder bath having a temperature of 260 ±5 °C to a point 2.0 to 2.5 mm from the body of the specimen, be held there for 10 ±1 s and then be stored at room temperature and normal humidity for 1 to 2 h. The change of V_V shall be measured and the specimen shall be visually examined.	$ \Delta V/V (1 \text{ mA}) \leq 5\%$ No visible damage
Tensile strength	IEC 60068-2-21, test Ua1 After gradually applying the force specified below and keeping the unit fixed for 10 s, the terminal shall be visually examined for any damage. Force for wire diameter: 0.6 mm = 10 N 0.8 mm = 10 N 1.0 mm = 20 N	$ \Delta V/V (1 \text{ mA}) \leq 5\%$ No break of solder joint, no wire break

Leaded varistors
B722*
EnergetiQ series

Test	Test methods/conditions	Requirement
Vibration	IEC 60068-2-6, test Fc, method B4 Frequency range: 10 ... 55 Hz Amplitude: 0.75 mm or 98 m/s ² Duration: 6 h (3 · 2 h) Pulse: sine wave After repeatedly applying a single harmonic vibration according to the table above. The change of V _v shall be measured and the specimen shall be visually examined.	ΔV/V (1 mA) ≤5% No visible damage
Bump	IEC 60068-2-29, test Eb Pulse duration: 6 ms Max. acceleration: 400 m/s ² Number of bumps: 4000 Pulse: half sine	ΔV/V (1 mA) ≤5% No visible damage
Fire hazard	IEC 60695-11-5 (needle flame test) Severity: vertical 10 s	5 s max.

Note:

UCT = Upper category temperature

LCT = Lower category temperature

 R_{ins} = Insulation resistance



v/i characteristics

$v = f(i)$ - for explanation of the characteristics refer to "General technical information", 1.6.3
 A = Leakage current, B = Protection level } for worst-case varistor tolerances

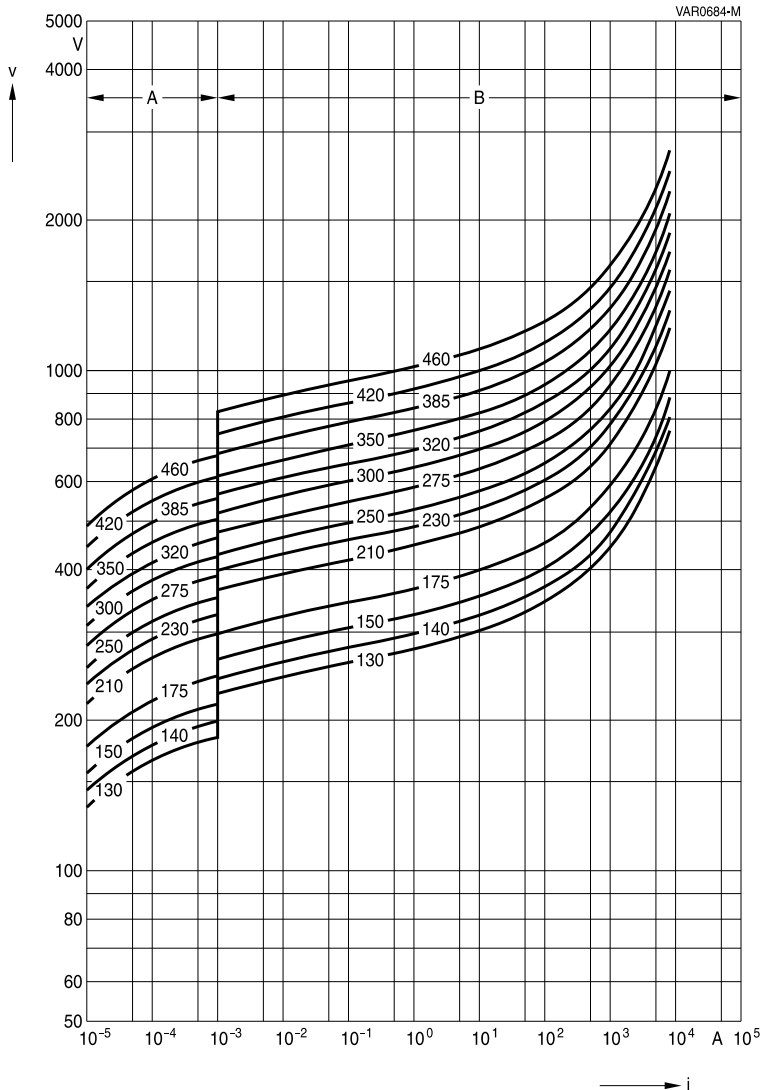

SIOV-Q14 ...

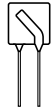

v/i characteristics

$v = f(i)$ - for explanation of the characteristics refer to "General technical information", 1.6.3
 A = Leakage current, B = Protection level } for worst-case varistor tolerances

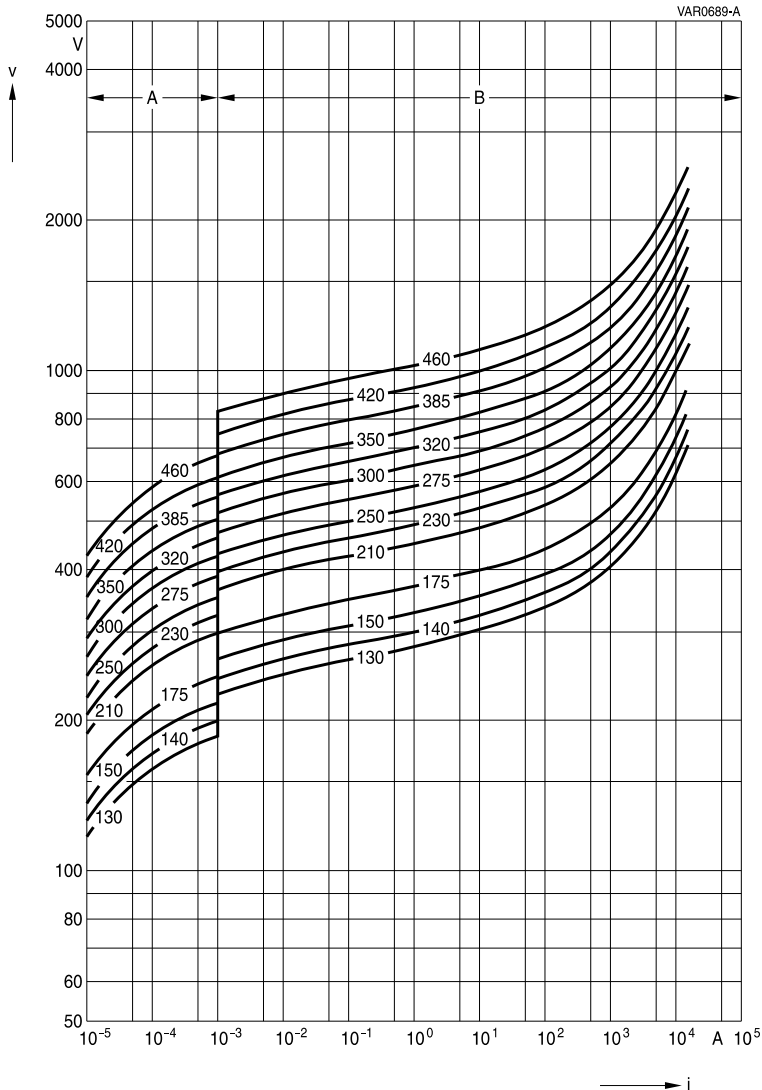

SIOV-Q20 ...

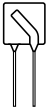

Derating curves

Maximum surge current $i_{max} = f(t_r, \text{pulse train})$

For explanation of the derating curves refer to "General technical information", section 1.8.1

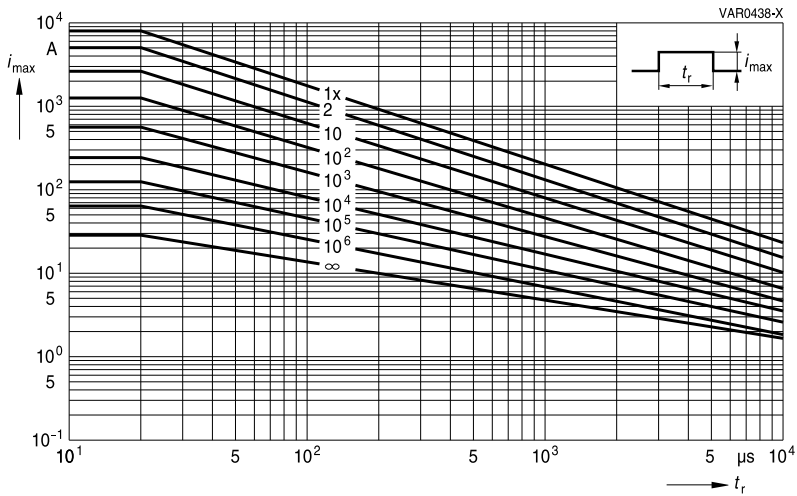

SIOV-Q14K130 ... K320

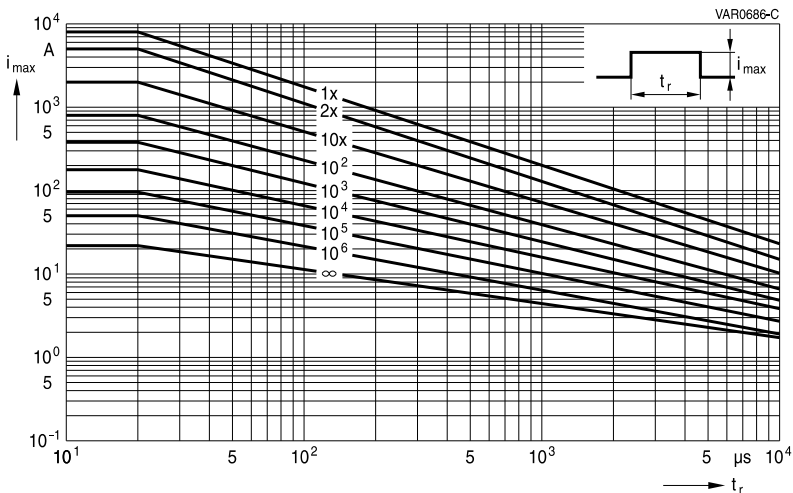

SIOV-Q14K350 ... K460

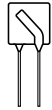

Derating curves

Maximum surge current $i_{max} = f(t_r, \text{pulse train})$

For explanation of the derating curves refer to "General technical information", section 1.8.1

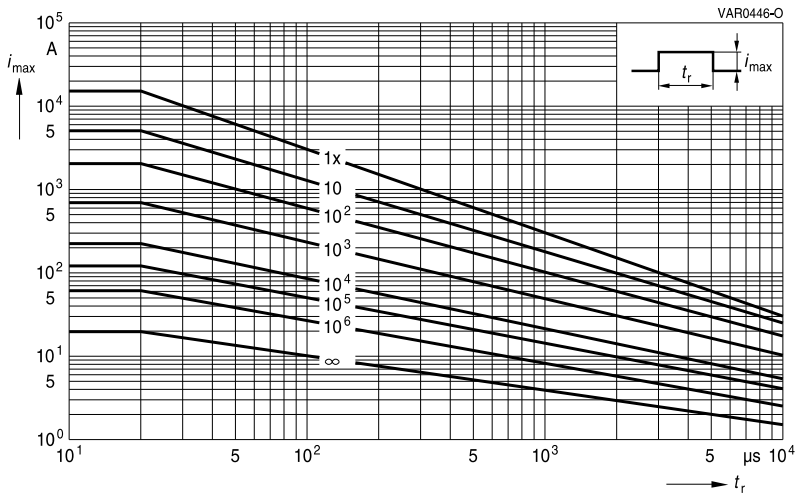

SIOV-Q20K130 ... K320

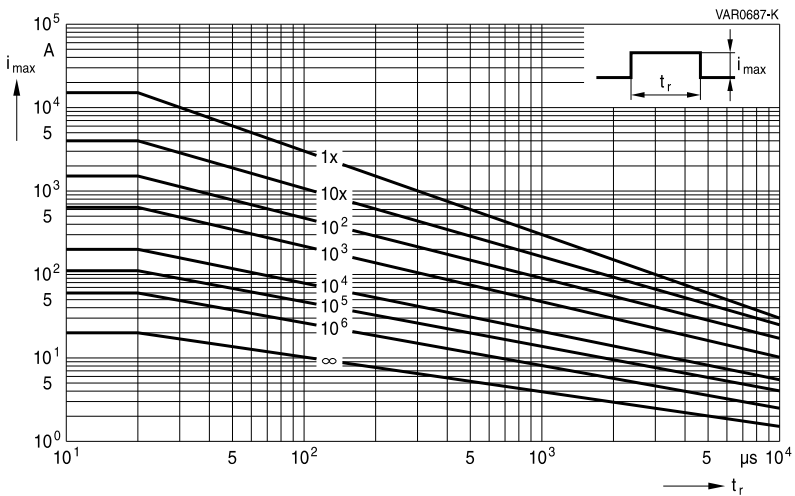

SIOV-Q20K350 ... K460

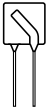
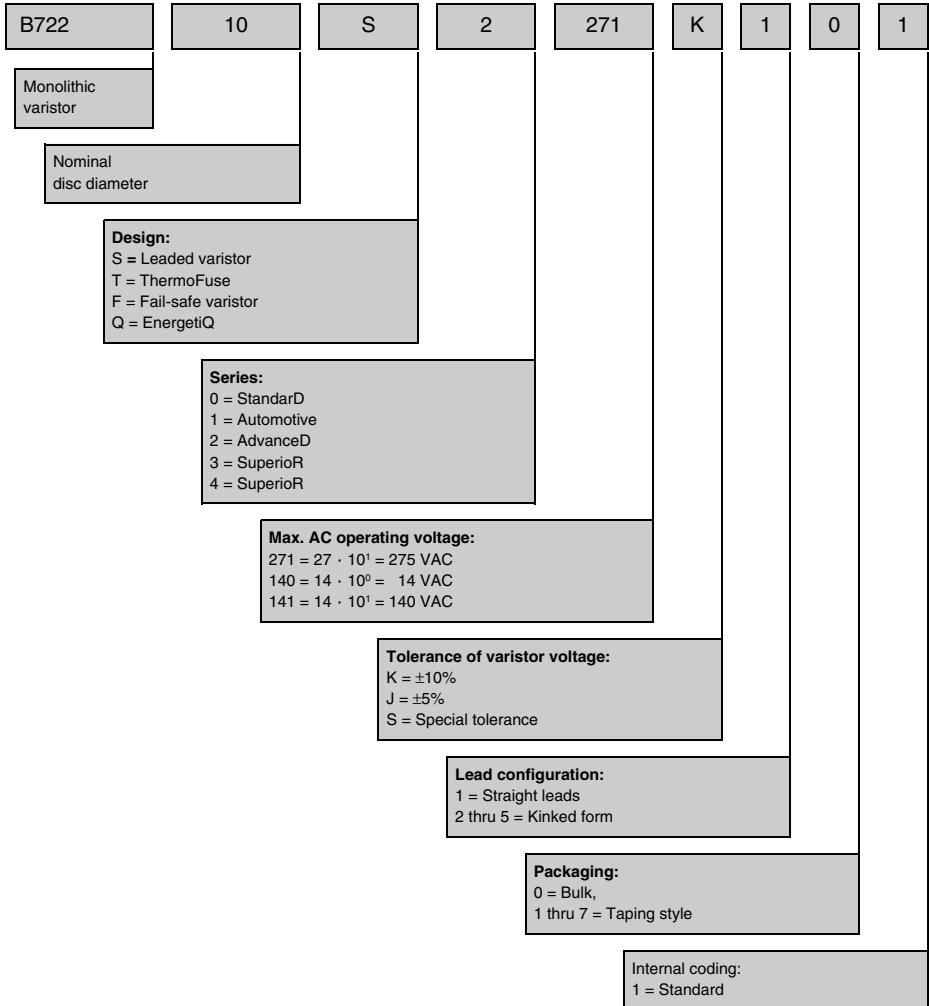

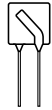
Taping, packaging and lead configuration
1 EPCOS ordering code system
For leaded varistors



2 Taping and packaging of leaded varistors

Tape packaging for lead spacing $\boxed{e} = 5$ fully conforms to IEC 60286-2, while for lead spacings $\boxed{e} = 7.5$ and 10 the taping mode is based on this standard.

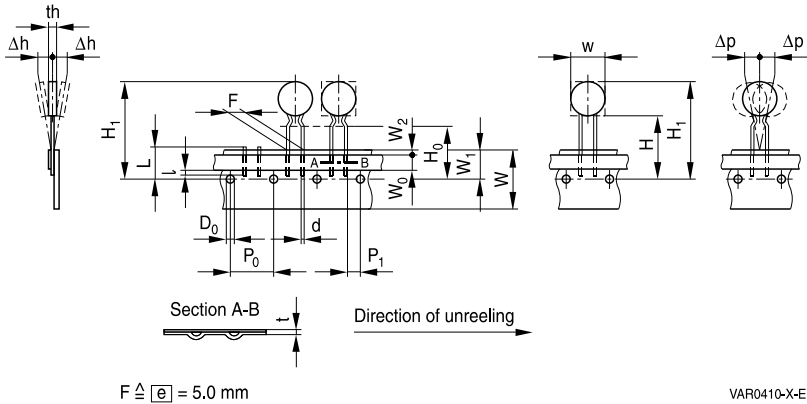
2.1 Taping in accordance with IEC 60286-2 for lead spacing 5.0 mm



2.2 Taping based on IEC 60286-2 for lead spacing 7.5 and 10 mm

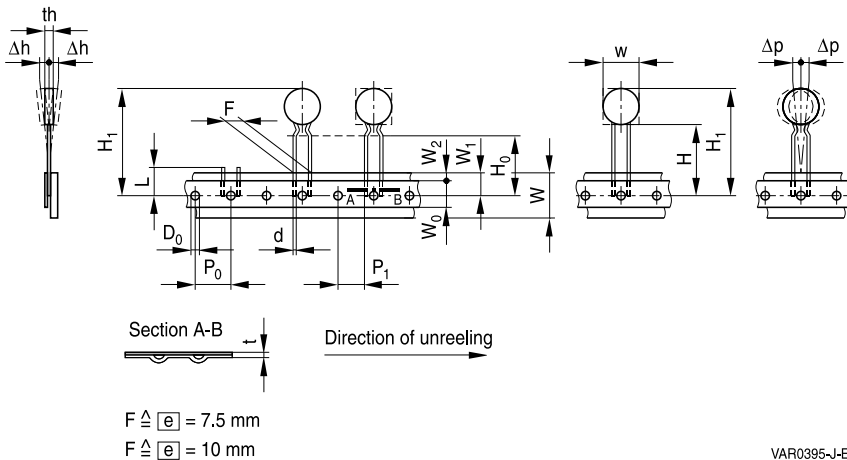

2.3 Tape dimensions (in mm)

Symbol	$e = 5.0$	Tolerance	$e = 7.5$	Tolerance	$e = 10.0$	Tolerance	Remarks	
w		max.		max.		max.	see tables in each series under "Dimensions"	
th		max.		max.		max.		
d	0.6	± 0.05	0.8	± 0.05	1.0	± 0.05		
P ₀	12.7	± 0.3	12.7 ¹⁾	± 0.3	12.7	± 0.3	± 1 mm/20 sprocket holes	
P ₁	3.85	± 0.7	8.95	± 0.8	7.7	± 0.8		
F	5.0	$+0.6/-0.1$	7.5	± 0.8	10.0	± 0.8	measured at top of component body	
Δh	0	± 2.0	depends on s		depends on s			
Δp	0	± 1.3	0	± 2.0	0	± 2.0		
W	18.0	± 0.5	18.0	± 0.5	18.0	± 0.5	Peel-off force ≥ 5 N	
W ₀	5.5	min.	11.0	min.	11.0	min.		
W ₁	9.0	± 0.5	9.0	$+0.75/-0.5$	9.0	$+0.75/-0.5$		
W ₂	3.0	max.	3.0	max.	3.0	max.		
H	18.0	$+2.0/-0$	18.0	$+2.0/-0$	18.0	$+2.0/-0$	²⁾	
H ₀	16.0 (18.0)	± 0.5	16.0 (18.0)	± 0.5	16.0	± 0.5		³⁾
H ₁	32.2	max.	45.0	max.	45.0	max.		
D ₀	4.0	± 0.2	4.0	± 0.2	4.0	± 0.2	without lead	
t	0.9	max.	0.9	max.	0.9	max.		
L	11.0	max.	11.0	max.	11.0	max.		
l	4.0	max.						

1) Taping with P₀ = 15.0 mm upon request

2) Applies only to uncrimped types

3) Applies only to crimped types (H₀ = 18 upon request)



2.4 Taping mode

Example: B72210S0271K1 5 1
|
Digit 14

Digit 14	Taping mode	Reel type	Seating plane height H ₀ for crimped types mm	Seating plane height H for uncrimped types mm	Pitch distance P ₀ mm
0	–	Bulk	–	–	–
1	G	I	16	18	12.7
2	G2	I	18	–	12.7
3	G3	II	16	18	12.7
4	G4	II	18	–	12.7
5	G5	III	16	18	12.7
6	GA	Ammo pack	16	18	12.7
7	G2A	Ammo pack	18	–	12.7
Internal coding for special taping					
	G6	III	18	–	12.7
	G10	II	16	18	15.0
	G11	II	18	–	15.0
	G10A	Ammo pack	16	18	15.0
	G11A	Ammo pack	18	–	15.0



2.5 Reel dimension

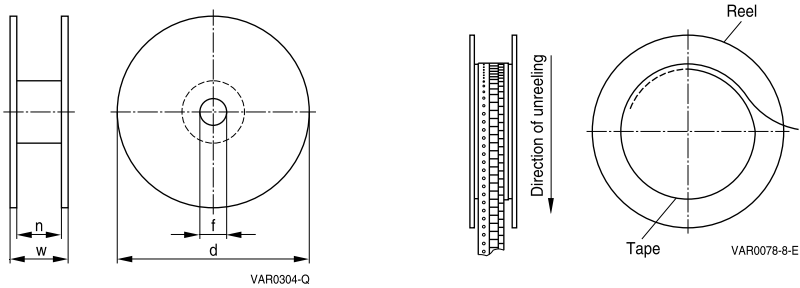

Dimensions (in mm)

Reel type	d	f	n	w
I	360 max.	31 ±1	approx. 45	54 max.
II	360 max.	31 ±1	approx. 55	64 max.
III	500 max.	23 ±1	approx. 59	72 max.

If reel type III is not compatible with insertion equipment because of its large diameter, nominal disk diameter 10 mm and 14 mm can be supplied on reel II upon request (taping mode G3).

2.6 Ammo pack dimensions

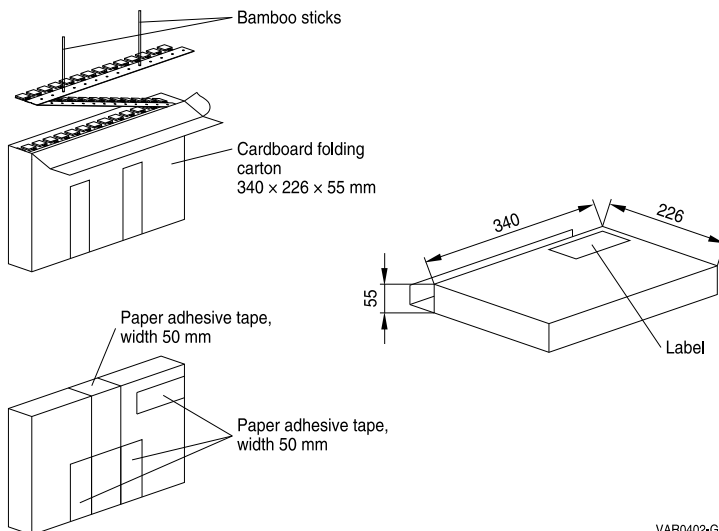

VAR0402-G



3 Lead configuration

Straight leads are standard for disk varistors. Other lead configurations as crimp style or customer-specific lead wire length according to 3.1, 3.2, 3.3 and 3.4 are optional. Crimped leads (non-standard) are differently crimped for technical reasons; the individual crimp styles are denoted by consecutive numbers (S, S2 through S5) as shown in the dimensional drawings below.

The crimp styles of the individual types can be seen from the type designation in the ordering tables.

3.1 Crimp style mode

Example: B72210S0271K 501
|
Digit 13

Digit 13 of ordering code	Crimp style	Figure
1	Standard, straight leads	1
2	S2	2
3	S3	3
4	S4	4
5	S5	5
Available upon request		
Internal coding	—	6

3.2 Standard leads and non-standard crimp styles

Standard, straight leads

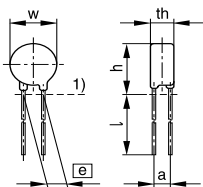

1) Seating plane to IEC 717
 VAR0586-W-E

Figure 1

Non-standard, crimp style S2

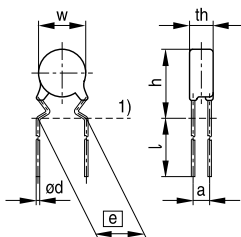

1) Seating plane to IEC 60717
 VAR0411-F-E

Figure 2

Non-standard, crimp style S3

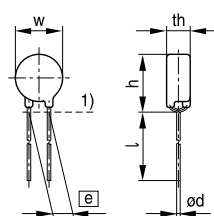

1) Seating plane to IEC 60717
 VAR0396-R-E

Figure 3

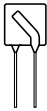
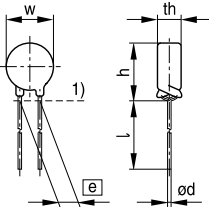
Non-standard, crimp style S4

1) Seating plane to IEC 60717

VAR0404-W-E

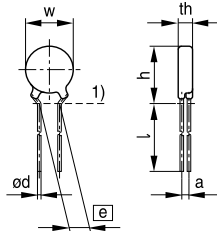
Non-standard, crimp style S5

1) Seating plane to IEC 60717

VAR0412-N-E

Figure 4
Figure 5

3.3 Component height (h_{max}) for crimped versions (non-standard)

Due to technical reasons the component height (h_{max}) increases if a crimp is added. The maximum height of the crimped component can be found in the table below.

Nominal diameter mm	V_{RMS} V	Crimp style	e mm	h_{max} mm
5	11 ... 175	S2	5.0	10.0
5	210 ... 460	S3	5.0	10.0
7	11 ... 175	S2	5.0	12.0
7	210 ... 460	S3	5.0	12.0
10	11 ... 300	S5	7.5	15.5
10	320 ... 460	S3/S5	7.5	16.5
10	510	S3/S5	7.5	17.5
10	Automotive	S5	7.5	17.0
10	Automotive (D1 types)	S5	7.5	16.0
10	11 ... 175	S4	5.0	16.5
10	210 ... 460	S3	5.0	16.5
14	11 ... 300	S5	7.5	20.0
14	320 ... 460	S3/S5	7.5	20.0
14	510	S3/S5	7.5	21.5
14	Automotive	S5	7.5	21.0
14	Automotive (D1 types)	S5	7.5	20.0
20	11 ... 320	S5	10.0	27.0
20	385 ... 510	S5	10.0	27.5

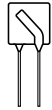

3.4 Trimmed leads (non-standard)

Varistors with cut leads available upon request.

Lead length tolerances:

Straight leads ± 1.0 mm

Crimped leads ± 0.8 mm

Minimum lead length 3.5 mm

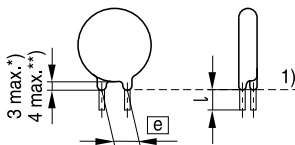

1) Seating plane to IEC 60717

*) For round component head

***) For EnergetiQ series, square component head

VAR0642-U-E

Figure 6



Mounting

1. Potting, sealing or adhesive compounds can produce chemical reactions in the SIOV ceramic that will degrade the component's electrical characteristics.
2. Overloading SIOVs may result in ruptured packages and expulsion of hot materials. For this reason SIOVs should be physically shielded from adjacent components.

Operation

1. Use SIOVs only within the specified temperature operating range.
2. Use SIOVs only within the specified voltage and current ranges.
3. Environmental conditions must not harm SIOVs. Use SIOVs only in normal atmospheric conditions. Avoid use in deoxidizing gases (chlorine gas, hydrogen sulfide gas, ammonia gas, sulfuric acid gas etc), corrosive agents, humid or salty conditions. Contact with any liquids and solvents should be prevented.

Display of ordering codes for EPCOS products

The ordering code for one and the same EPCOS product can be represented differently in data sheets, data books, other publications, on the EPCOS website, or in order-related documents such as shipping notes, order confirmations and product labels. **The varying representations of the ordering codes are due to different processes employed and do not affect the specifications of the respective products.** Detailed information can be found on the Internet under www.epcos.com/orderingcodes

Symbols and terms

Symbol	Term
C	Capacitance
C_{typ}	Typical capacitance
i	Current
i_c	Current at which $V_{c, max}$ is measured
I_{leak}	Leakage current
i_{max}	Maximum surge current (also termed peak current)
I_{max}	Maximum discharge current
I_n	Nominal discharge current
LCT	Lower category temperature
L_{typ}	Typical inductance
P_{max}	Maximum average power dissipation
R_{ins}	Insulation resistance
R_{min}	Minimum resistance
T_A	Ambient temperature
t_r	Duration of equivalent rectangular wave
UCT	Upper category temperature
v	Voltage
V_{clamp}	Clamping voltage
$V_{c, max}$	Maximum clamping voltage at specified current i_c
V_{DC}	DC operating voltage
V_{jump}	Maximum jump start voltage
V_{max}	Maximum voltage
V_{op}	Operating voltage
V_{RMS}	AC operating voltage, root-mean-square value
$V_{RMS, op, max}$	Root-mean-square value of max. DC operating voltage incl. ripple current
V_{surge}	Super imposed surge voltage
V_V	Varistor voltage
ΔV_V	Tolerance of varistor voltage
W_{LD}	Maximum load dump
W_{max}	Maximum energy absorption
e	Lead spacing

All dimensions are given in mm.

The commas used in numerical values denote decimal points.

Important notes

The following applies to all products named in this publication:

1. Some parts of this publication contain **statements about the suitability of our products for certain areas of application**. These statements are based on our knowledge of typical requirements that are often placed on our products in the areas of application concerned. We nevertheless expressly point out **that such statements cannot be regarded as binding statements about the suitability of our products for a particular customer application**. As a rule, EPCOS is either unfamiliar with individual customer applications or less familiar with them than the customers themselves. For these reasons, it is always ultimately incumbent on the customer to check and decide whether an EPCOS product with the properties described in the product specification is suitable for use in a particular customer application.
2. We also point out that **in individual cases, a malfunction of electronic components or failure before the end of their usual service life cannot be completely ruled out in the current state of the art, even if they are operated as specified**. In customer applications requiring a very high level of operational safety and especially in customer applications in which the malfunction or failure of an electronic component could endanger human life or health (e.g. in accident prevention or lifesaving systems), it must therefore be ensured by means of suitable design of the customer application or other action taken by the customer (e.g. installation of protective circuitry or redundancy) that no injury or damage is sustained by third parties in the event of malfunction or failure of an electronic component.
3. **The warnings, cautions and product-specific notes must be observed.**
4. In order to satisfy certain technical requirements, **some of the products described in this publication may contain substances subject to restrictions in certain jurisdictions (e.g. because they are classed as hazardous)**. Useful information on this will be found in our Material Data Sheets on the Internet (www.epcos.com/material). Should you have any more detailed questions, please contact our sales offices.
5. We constantly strive to improve our products. Consequently, **the products described in this publication may change from time to time**. The same is true of the corresponding product specifications. Please check therefore to what extent product descriptions and specifications contained in this publication are still applicable before or when you place an order. We also **reserve the right to discontinue production and delivery of products**. Consequently, we cannot guarantee that all products named in this publication will always be available. The aforementioned does not apply in the case of individual agreements deviating from the foregoing for customer-specific products.
6. Unless otherwise agreed in individual contracts, **all orders are subject to the current version of the "General Terms of Delivery for Products and Services in the Electrical Industry" published by the German Electrical and Electronics Industry Association (ZVEI)**.

Important notes

7. The trade names EPCOS, CeraCharge, CeraDiode, CeraLink, CeraPad, CeraPlas, CSMP, CTVS, DeltaCap, DigiSiMic, ExoCore, FilterCap, FormFit, LeaXield, MiniBlue, MiniCell, MKD, MKK, MotorCap, PCC, PhaseCap, PhaseCube, PhaseMod, PhiCap, PowerHap, PQSine, PQvar, SIFERRIT, SIFI, SIKOREL, SilverCap, SIMDAD, SiMic, SIMID, SineFormer, SIOV, ThermoFuse, WindCap are **trademarks registered or pending** in Europe and in other countries. Further information will be found on the Internet at www.epcos.com/trademarks.