

## SN74AHCT1G04 Single Inverter Gate

### 1 Features

- Operating Range 4.5-V to 5.5-V
- Max  $t_{pd}$  of 7.5 ns at 5-V
- Low Power Consumption, 10- $\mu$ A Max  $I_{CC}$
- $\pm 8$ -mA Output Drive at 5-V
- Inputs are TTL-Voltage Compatible
- Latch-Up Performance Exceeds 250 mA Per JESD 17

### 2 Applications

- Notebook PCs
- Electronic Points of Sale
- Patient Monitoring
- Motor Controls: AC Induction
- Network Switches
- Tests

### 3 Description

The SN74AHCT1G04 contains one gate. The device performs the Boolean function  $Y = \bar{A}$ .

#### Device Information<sup>(1)</sup>

PART NUMBER	PACKAGE	BODY SIZE (NOM)
SN74AHCT1G04	SOT-23 (5)	2.90 mm x 1.60 mm
	SC-70 (5)	2.00 mm x 1.30 mm

(1) For all available packages, see the orderable addendum at the end of the data sheet.

### 4 Simplified Schematic

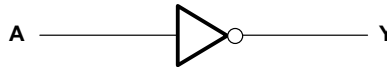

## Table of Contents

<b>1 Features</b> .....	<b>1</b>	9.1 Overview .....	<b>7</b>
<b>2 Applications</b> .....	<b>1</b>	9.2 Functional Block Diagram .....	<b>7</b>
<b>3 Description</b> .....	<b>1</b>	9.3 Feature Description .....	<b>7</b>
<b>4 Simplified Schematic</b> .....	<b>1</b>	9.4 Device Functional Modes .....	<b>7</b>
<b>5 Revision History</b> .....	<b>2</b>	<b>10 Application and Implementation</b> .....	<b>8</b>
<b>6 Pin Configuration and Functions</b> .....	<b>3</b>	10.1 Application Information .....	<b>8</b>
<b>7 Specifications</b> .....	<b>4</b>	10.2 Typical Application .....	<b>8</b>
7.1 Absolute Maximum Ratings .....	<b>4</b>	<b>11 Power Supply Recommendations</b> .....	<b>9</b>
7.2 ESD Ratings .....	<b>4</b>	<b>12 Layout</b> .....	<b>10</b>
7.3 Recommended Operating Conditions .....	<b>4</b>	12.1 Layout Guidelines .....	<b>10</b>
7.4 Thermal Information .....	<b>4</b>	12.2 Layout Example .....	<b>10</b>
7.5 Electrical Characteristics .....	<b>5</b>	<b>13 Device and Documentation Support</b> .....	<b>10</b>
7.6 Switching Characteristics .....	<b>5</b>	13.1 Trademarks .....	<b>10</b>
7.7 Operating Characteristics .....	<b>5</b>	13.2 Electrostatic Discharge Caution .....	<b>10</b>
7.8 Typical Characteristics .....	<b>5</b>	13.3 Glossary .....	<b>10</b>
<b>8 Parameter Measurement Information</b> .....	<b>6</b>	<b>14 Mechanical, Packaging, and Orderable Information</b> .....	<b>10</b>
<b>9 Detailed Description</b> .....	<b>7</b>		

## 5 Revision History

### Changes from Revision O (October 2013) to Revision P

Page

• Added <i>Applications</i> , <i>Device Information</i> table, <i>Pin Functions</i> table, <i>ESD Ratings</i> table, <i>Thermal Information</i> table, <i>Typical Characteristics</i> , <i>Feature Description</i> section, <i>Device Functional Modes</i> , <i>Application and Implementation</i> section, <i>Power Supply Recommendations</i> section, <i>Layout</i> section, <i>Device and Documentation Support</i> section, and <i>Mechanical, Packaging, and Orderable Information</i> section. ....	<b>1</b>
• Deleted <i>Ordering Information</i> table. ....	<b>1</b>
• Changed MAX operating temperature to 125°C in <i>Recommended Operating Conditions</i> table. ....	<b>4</b>

## 6 Pin Configuration and Functions

**DBV OR DCK PACKAGE  
(TOP VIEW)**

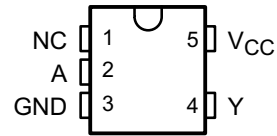

NC – No internal connection

### Pin Functions

PIN		TYPE	DESCRIPTION
NO.	NAME		
1	NC	—	No Connection
2	A	I	Input A
3	GND	—	Ground Pin
4	Y	O	Output Y
5	V <sub>CC</sub>	—	Power Pin

## 7 Specifications

### 7.1 Absolute Maximum Ratings

 over operating free-air temperature range (unless otherwise noted)<sup>(1)</sup>

		MIN	MAX	UNIT
V <sub>CC</sub>	Supply voltage range	-0.5	7	V
V <sub>I</sub>	Input voltage range <sup>(2)</sup>	-0.5	7	V
V <sub>O</sub>	Output voltage range <sup>(2)</sup>	-0.5	V <sub>CC</sub> + 0.5	V
I <sub>IK</sub>	Input clamp current	V <sub>I</sub> < 0	-20	mA
I <sub>OK</sub>	Output clamp current	V <sub>O</sub> < 0 or V <sub>O</sub> > V <sub>CC</sub>	±20	mA
I <sub>O</sub>	Continuous output current	V <sub>O</sub> = 0 to V <sub>CC</sub>	±25	mA
	Continuous current through V <sub>CC</sub> or GND		±50	mA
T <sub>stg</sub>	Storage temperature range	-65	150	°C

- (1) Stresses beyond those listed under *Absolute Maximum Ratings* may cause permanent damage to the device. These are stress ratings only, and functional operation of the device at these or any other conditions beyond those indicated under *Recommended Operating Conditions*<sup>(1)</sup> is not implied. Exposure to absolute-maximum-rated conditions for extended periods may affect device reliability.
- (2) The input and output voltage ratings may be exceeded if the input and output current ratings are observed.

### 7.2 ESD Ratings

		VALUE	UNIT
V <sub>(ESD)</sub>	Electrostatic discharge	Human body model (HBM), per ANSI/ESDA/JEDEC JS-001, all pins <sup>(1)</sup>	1500
		Charged device model (CDM), per JEDEC specification JESD22-C101, all pins <sup>(2)</sup>	1000

- (1) JEDEC document JEP155 states that 500-V HBM allows safe manufacturing with a standard ESD control process.
- (2) JEDEC document JEP157 states that 250-V CDM allows safe manufacturing with a standard ESD control process.

### 7.3 Recommended Operating Conditions<sup>(1)</sup>

		MIN	MAX	UNIT
V <sub>CC</sub>	Supply voltage	4.5	5.5	V
V <sub>IH</sub>	High-level input voltage	2		V
V <sub>IL</sub>	Low-level Input voltage		0.8	V
V <sub>I</sub>	Input voltage	0	5.5	V
V <sub>O</sub>	Output voltage	0	V <sub>CC</sub>	V
I <sub>OH</sub>	High-level output current		-8	mA
I <sub>OL</sub>	Low-level output current		8	mA
Δt/Δv	Input Transition rise or fall rate		20	ns/V
T <sub>A</sub>	Operating free-air temperature	-40	125	°C

- (1) All unused inputs of the device must be held at V<sub>CC</sub> or GND to ensure proper device operation. Refer to the TI application report, *Implications of Slow or Floating CMOS Inputs (SCBA004)*

### 7.4 Thermal Information

THERMAL METRIC <sup>(1)</sup>	SN74AHCT1G04		UNIT	
	DBV	DCK		
	5 PINS			
R <sub>θJA</sub>	Junction-to-ambient thermal resistance	231.3	287.6	°C/W
R <sub>θJC(top)</sub>	Junction-to-case (top) thermal resistance	119.9	97.7	
R <sub>θJB</sub>	Junction-to-board thermal resistance	60.6	65.	
Ψ <sub>JT</sub>	Junction-to-top characterization parameter	17.8	2.0	
Ψ <sub>JB</sub>	Junction-to-board characterization parameter	60.1	64.2	

- (1) For more information about traditional and new thermal metrics, see the *IC Package Thermal Metrics* application report (SPRA953).

### 7.5 Electrical Characteristics

over operating free-air temperature range (unless otherwise noted)

PARAMETER	TEST CONDITIONS	V <sub>CC</sub>	T <sub>A</sub> = 25°C			–40°C to 85°C		–40°C to 125°C		UNIT
			MIN	TYP	MAX	MIN	MAX	MIN	MAX	
V <sub>OH</sub>	I <sub>OH</sub> = –50 μA	4.5 V	4.4	4.5		4.4		4.4	V	
	I <sub>OH</sub> = –8 mA		3.94			3.8		3.8		
V <sub>OL</sub>	I <sub>OL</sub> = 50 μA	4.5 V			0.1		0.1	0.1	V	
	I <sub>OL</sub> = 8 mA				0.36		0.44	0.44		
I <sub>I</sub>	V <sub>I</sub> = 5.5 V or GND	0 V to 5.5 V			±0.1		±1	±1	μA	
I <sub>CC</sub>	V <sub>I</sub> = V <sub>CC</sub> or GND, I <sub>O</sub> = 0	5.5 V			1		10	10	μA	
ΔI <sub>CC</sub> <sup>(1)</sup>	One input at 3.4 V, Other Inputs at V <sub>CC</sub> or GND	5.5 V			1.35		1.5	1.5	mA	
C <sub>i</sub>	V <sub>I</sub> = V <sub>CC</sub> or GND	5 V		4			10	10	pF	

(1) This is the increase in supply current for each input at one of the specified TTL voltage levels, rather than 0 V or V<sub>CC</sub>.

### 7.6 Switching Characteristics

over recommended operating free-air temperature range, V<sub>CC</sub> = 5 V ± 0.5 V (unless otherwise noted) (see Figure 2)

PARAMETER	FROM (INPUT)	TO (OUTPUT)	OUTPUT CAPACITANCE	T <sub>A</sub> = 25°C		–40°C to 85°C		–40°C to 125°C		UNIT
				TYP	MAX	MIN	MAX	MIN	MAX	
t <sub>PLH</sub>	A or B	Y	C <sub>L</sub> = 15 pF	4.7		1	7.5	1	8	ns
t <sub>PHL</sub>				4.7		1	7.5	1	8	
t <sub>PLH</sub>	A or B	Y	C <sub>L</sub> = 50 pF	5.5		1	8.5	1	9	ns
t <sub>PHL</sub>				5.5		1	8.5	1	9	

### 7.7 Operating Characteristics

V<sub>CC</sub> = 5 V, T<sub>A</sub> = 25°C

PARAMETER	TEST CONDITIONS	TYP	UNIT
C <sub>pd</sub> Power dissipation capacitance	No load, f = 1 MHz	14	pF

### 7.8 Typical Characteristics

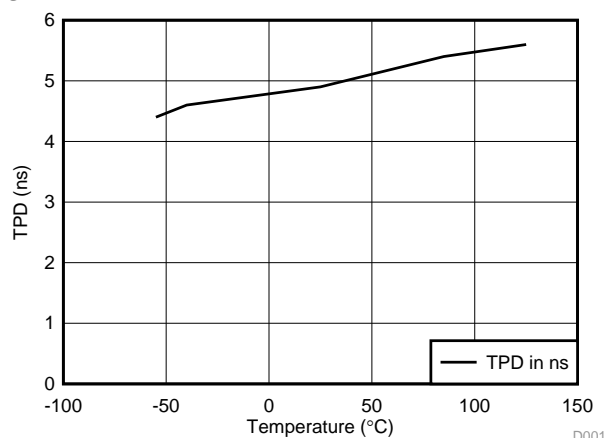
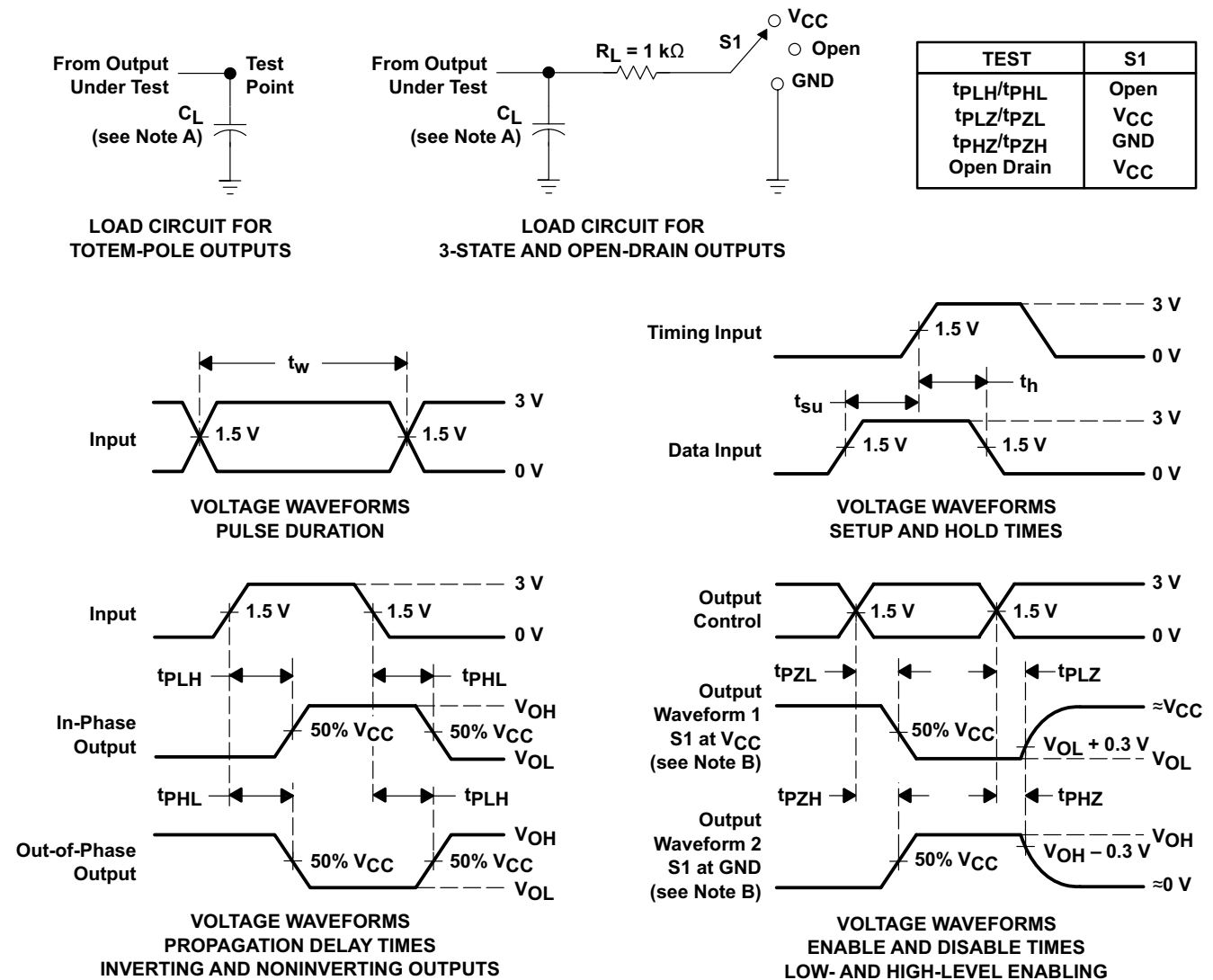

Figure 1. TPD vs Temperature

## 8 Parameter Measurement Information



- A.  $C_L$  includes probe and jig capacitance.
- B. Waveform 1 is for an output with internal conditions such that the output is low except when disabled by the output control.  
Waveform 2 is for an output with internal conditions such that the output is high except when disabled by the output control.
- C. All input pulses are supplied by generators having the following characteristics:  $PRR \leq 1\text{ MHz}$ ,  $Z_O = 50\ \Omega$ ,  $t_r \leq 3\text{ ns}$ ,  $t_f \leq 3\text{ ns}$ .
- D. The outputs are measured one at a time with one input transition per measurement.
- E. All parameters and waveforms are not applicable to all devices.

**Figure 2. Load Circuit And Voltage Waveforms**

## 9 Detailed Description

### 9.1 Overview

The SN74AHCT1G04 device contains one inverter. This device has TTL input levels that allow up translation from 3.3 V to 5 V.

### 9.2 Functional Block Diagram

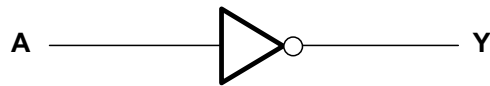

**Figure 3. Logic Diagram (Positive Logic)**

### 9.3 Feature Description

- $V_{CC}$  is optimized at 5 V
- Allows up voltage translation from 3.3 V to 5 V
  - Inputs accept  $V_{IH}$  levels of 2 V
- Slow edge rates minimize output ringing
- Inputs are TTL-Voltage compatible

### 9.4 Device Functional Modes

**Table 1. Function Table**

INPUT A	OUTPUT Y
H	L
L	H

## 10 Application and Implementation

### NOTE

Information in the following applications sections is not part of the TI component specification, and TI does not warrant its accuracy or completeness. TI's customers are responsible for determining suitability of components for their purposes. Customers should validate and test their design implementation to confirm system functionality.

### 10.1 Application Information

SN74AHCT1G04 is a low-drive CMOS device that can be used for a multitude of inverting type applications where output ringing is a concern. The low drive and slow edge rates will minimize overshoot and undershoot on the outputs. The input switching levels have been lowered to accommodate TTL inputs of  $0.8\text{ V } V_{IL}$  and  $2\text{ V } V_{IH}$ . This feature makes it ideal for translating up from  $3.3\text{ V}$  to  $5\text{ V}$ . [Figure 5](#) shows this type of translation.

### 10.2 Typical Application

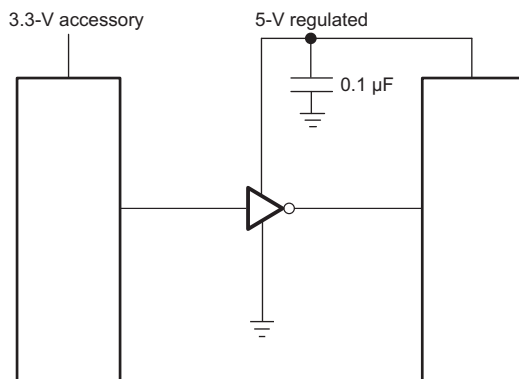

**Figure 4. Typical Application Schematic**

#### 10.2.1 Design Requirements

This device uses CMOS technology and has balanced output drive. Care should be taken to avoid bus contention because it can drive currents that would exceed maximum limits. The high drive will also create fast edges into light loads, so routing and load conditions should be considered to prevent ringing.

#### 10.2.2 Detailed Design Procedure

1. Recommended Input Conditions
    - For rise time and fall time specifications, see  $\Delta t/\Delta V$  in the [Recommended Operating Conditions<sup>\(1\)</sup>](#) table.
    - For specified High and low levels, see  $V_{IH}$  and  $V_{IL}$  in the [Recommended Operating Conditions<sup>\(1\)</sup>](#) table.
    - Inputs are overvoltage tolerant allowing them to go as high as  $5.5\text{ V}$  at any valid  $V_{CC}$ .
  2. Recommend Output Conditions
    - Load currents should not exceed  $25\text{ mA}$  per output and  $50\text{ mA}$  total for the part.
    - Outputs should not be pulled above  $V_{CC}$ .
- (1) All unused inputs of the device must be held at  $V_{CC}$  or GND to ensure proper device operation. Refer to the TI application report, [Implications of Slow or Floating CMOS Inputs \(SCBA004\)](#)



## Typical Application (continued)

### 10.2.3 Application Curves

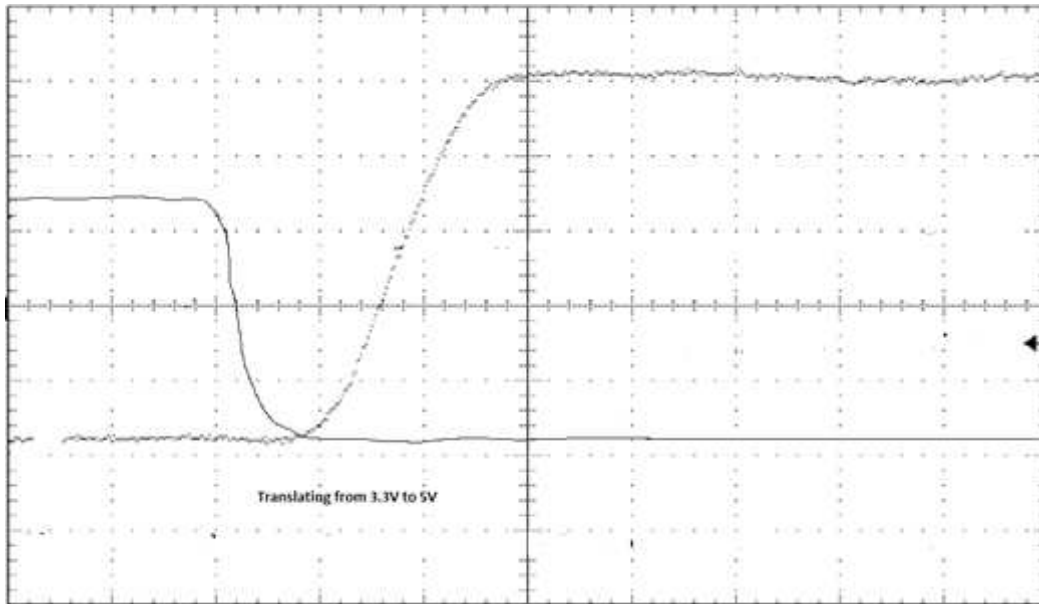

Figure 5. 3.3-V to 5-V Translation

## 11 Power Supply Recommendations

The power supply can be any voltage between the MIN and MAX supply voltage rating located in the [Recommended Operating Conditions<sup>\(1\)</sup>](#) table.

Each  $V_{CC}$  pin should have a good bypass capacitor to prevent power disturbance. For devices with a single supply, 0.1  $\mu\text{F}$  is recommended. If there are multiple  $V_{CC}$  pins, 0.01  $\mu\text{F}$  or 0.022  $\mu\text{F}$  is recommended for each power pin. It is acceptable to parallel multiple bypass caps to reject different frequencies of noise. A 0.1  $\mu\text{F}$  and 1  $\mu\text{F}$  are commonly used in parallel. The bypass capacitor should be installed as close to the power pin as possible for best results.

## 12 Layout

### 12.1 Layout Guidelines

When using multiple bit logic devices, inputs should not float. In many cases, functions or parts of functions of digital logic devices are unused. Some examples are when only two inputs of a triple-input AND gate are used, or when only 3 of the 4-buffer gates are used. Such input pins should not be left unconnected because the undefined voltages at the outside connections result in undefined operational states.

Specified in [Figure 6](#) are rules that must be observed under all circumstances. All unused inputs of digital logic devices must be connected to a high or low bias to prevent them from floating. The logic level that should be applied to any particular unused input depends on the function of the device. Generally they will be tied to GND or  $V_{CC}$ , whichever makes more sense or is more convenient. It is acceptable to float outputs unless the part is a transceiver. If the transceiver has an output enable pin, it will disable the outputs section of the part when asserted. This will not disable the input section of the I/Os so they also cannot float when disabled.

### 12.2 Layout Example

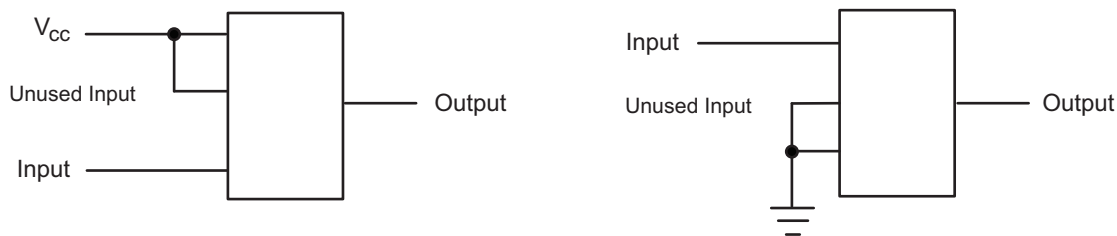

Figure 6. Layout Diagram

## 13 Device and Documentation Support

### 13.1 Trademarks

All trademarks are the property of their respective owners.

### 13.2 Electrostatic Discharge Caution



These devices have limited built-in ESD protection. The leads should be shorted together or the device placed in conductive foam during storage or handling to prevent electrostatic damage to the MOS gates.

### 13.3 Glossary

[SLYZ022](#) — *TI Glossary*.

This glossary lists and explains terms, acronyms, and definitions.

## 14 Mechanical, Packaging, and Orderable Information

The following pages include mechanical, packaging, and orderable information. This information is the most current data available for the designated devices. This data is subject to change without notice and revision of this document. For browser-based versions of this data sheet, refer to the left-hand navigation.

**PACKAGING INFORMATION**

Orderable Device	Status (1)	Package Type	Package Drawing	Pins	Package Qty	Eco Plan (2)	Lead/Ball Finish (6)	MSL Peak Temp (3)	Op Temp (°C)	Device Marking (4/5)	Samples
74AHCT1G04DBVRE4	ACTIVE	SOT-23	DBV	5	3000	Green (RoHS & no Sb/Br)	CU NIPDAU	Level-1-260C-UNLIM	-40 to 125	B04G	<a href="#">Samples</a>
74AHCT1G04DBVRG4	ACTIVE	SOT-23	DBV	5	3000	Green (RoHS & no Sb/Br)	CU NIPDAU	Level-1-260C-UNLIM	-40 to 125	B04G	<a href="#">Samples</a>
74AHCT1G04DBVTE4	ACTIVE	SOT-23	DBV	5	250	Green (RoHS & no Sb/Br)	CU NIPDAU	Level-1-260C-UNLIM	-40 to 125	B04G	<a href="#">Samples</a>
74AHCT1G04DBVTG4	ACTIVE	SOT-23	DBV	5	250	Green (RoHS & no Sb/Br)	CU NIPDAU	Level-1-260C-UNLIM	-40 to 125	B04G	<a href="#">Samples</a>
74AHCT1G04DCKRE4	ACTIVE	SC70	DCK	5	3000	Green (RoHS & no Sb/Br)	CU NIPDAU	Level-1-260C-UNLIM	-40 to 125	(BC3 ~ BCG ~ BCJ ~ BCL ~ BCS)	<a href="#">Samples</a>
74AHCT1G04DCKRG4	ACTIVE	SC70	DCK	5	3000	Green (RoHS & no Sb/Br)	CU NIPDAU	Level-1-260C-UNLIM	-40 to 125	(BC3 ~ BCG ~ BCJ ~ BCL ~ BCS)	<a href="#">Samples</a>
74AHCT1G04DCKTG4	ACTIVE	SC70	DCK	5	250	Green (RoHS & no Sb/Br)	CU NIPDAU	Level-1-260C-UNLIM	-40 to 125	(BC3 ~ BCG ~ BCL ~ BCS)	<a href="#">Samples</a>
SN74AHCT1G04DBVR	ACTIVE	SOT-23	DBV	5	3000	Green (RoHS & no Sb/Br)	CU NIPDAU   CU SN	Level-1-260C-UNLIM	-40 to 125	(B043 ~ B04G ~ B04J ~ B04L ~ B04S)	<a href="#">Samples</a>
SN74AHCT1G04DBVT	ACTIVE	SOT-23	DBV	5	250	Green (RoHS & no Sb/Br)	CU NIPDAU   CU SN	Level-1-260C-UNLIM	-40 to 125	(B043 ~ B04G ~ B04L ~ B04S)	<a href="#">Samples</a>
SN74AHCT1G04DCKR	ACTIVE	SC70	DCK	5	3000	Green (RoHS & no Sb/Br)	CU NIPDAU	Level-1-260C-UNLIM	-40 to 125	(BC3 ~ BCG ~ BCJ ~ BCL ~ BCS)	<a href="#">Samples</a>
SN74AHCT1G04DCKT	ACTIVE	SC70	DCK	5	250	Green (RoHS & no Sb/Br)	CU NIPDAU	Level-1-260C-UNLIM	-40 to 125	(BC3 ~ BCG ~ BCL ~ BCS)	<a href="#">Samples</a>

(1) The marketing status values are defined as follows:

**ACTIVE:** Product device recommended for new designs.

**LIFEBUY:** TI has announced that the device will be discontinued, and a lifetime-buy period is in effect.

**NRND:** Not recommended for new designs. Device is in production to support existing customers, but TI does not recommend using this part in a new design.

**PREVIEW:** Device has been announced but is not in production. Samples may or may not be available.

**OBSELETE:** TI has discontinued the production of the device.

(2) Eco Plan - The planned eco-friendly classification: Pb-Free (RoHS), Pb-Free (RoHS Exempt), or Green (RoHS & no Sb/Br) - please check <http://www.ti.com/productcontent> for the latest availability information and additional product content details.

**TBD:** The Pb-Free/Green conversion plan has not been defined.

**Pb-Free (RoHS):** TI's terms "Lead-Free" or "Pb-Free" mean semiconductor products that are compatible with the current RoHS requirements for all 6 substances, including the requirement that lead not exceed 0.1% by weight in homogeneous materials. Where designed to be soldered at high temperatures, TI Pb-Free products are suitable for use in specified lead-free processes.

---

**Pb-Free (RoHS Exempt):** This component has a RoHS exemption for either 1) lead-based flip-chip solder bumps used between the die and package, or 2) lead-based die adhesive used between the die and leadframe. The component is otherwise considered Pb-Free (RoHS compatible) as defined above.

**Green (RoHS & no Sb/Br):** TI defines "Green" to mean Pb-Free (RoHS compatible), and free of Bromine (Br) and Antimony (Sb) based flame retardants (Br or Sb do not exceed 0.1% by weight in homogeneous material)

<sup>(3)</sup> MSL, Peak Temp. - The Moisture Sensitivity Level rating according to the JEDEC industry standard classifications, and peak solder temperature.

<sup>(4)</sup> There may be additional marking, which relates to the logo, the lot trace code information, or the environmental category on the device.

<sup>(5)</sup> Multiple Device Markings will be inside parentheses. Only one Device Marking contained in parentheses and separated by a "~" will appear on a device. If a line is indented then it is a continuation of the previous line and the two combined represent the entire Device Marking for that device.

<sup>(6)</sup> Lead/Ball Finish - Orderable Devices may have multiple material finish options. Finish options are separated by a vertical ruled line. Lead/Ball Finish values may wrap to two lines if the finish value exceeds the maximum column width.

**Important Information and Disclaimer:** The information provided on this page represents TI's knowledge and belief as of the date that it is provided. TI bases its knowledge and belief on information provided by third parties, and makes no representation or warranty as to the accuracy of such information. Efforts are underway to better integrate information from third parties. TI has taken and continues to take reasonable steps to provide representative and accurate information but may not have conducted destructive testing or chemical analysis on incoming materials and chemicals. TI and TI suppliers consider certain information to be proprietary, and thus CAS numbers and other limited information may not be available for release.

In no event shall TI's liability arising out of such information exceed the total purchase price of the TI part(s) at issue in this document sold by TI to Customer on an annual basis.

**OTHER QUALIFIED VERSIONS OF SN74AHCT1G04 :**

- Automotive: [SN74AHCT1G04-Q1](#)

NOTE: Qualified Version Definitions:

- Automotive - Q100 devices qualified for high-reliability automotive applications targeting zero defects

**TAPE AND REEL INFORMATION**

**QUADRANT ASSIGNMENTS FOR PIN 1 ORIENTATION IN TAPE**

\*All dimensions are nominal

Device	Package Type	Package Drawing	Pins	SPQ	Reel Diameter (mm)	Reel Width W1 (mm)	A0 (mm)	B0 (mm)	K0 (mm)	P1 (mm)	W (mm)	Pin1 Quadrant
74AHCT1G04DBVRG4	SOT-23	DBV	5	3000	178.0	9.0	3.23	3.17	1.37	4.0	8.0	Q3
74AHCT1G04DBVTG4	SOT-23	DBV	5	250	178.0	9.0	3.23	3.17	1.37	4.0	8.0	Q3
SN74AHCT1G04DBVR	SOT-23	DBV	5	3000	178.0	9.2	3.3	3.23	1.55	4.0	8.0	Q3
SN74AHCT1G04DBVR	SOT-23	DBV	5	3000	178.0	9.0	3.23	3.17	1.37	4.0	8.0	Q3
SN74AHCT1G04DBVT	SOT-23	DBV	5	250	178.0	9.2	3.3	3.23	1.55	4.0	8.0	Q3
SN74AHCT1G04DBVT	SOT-23	DBV	5	250	178.0	9.0	3.23	3.17	1.37	4.0	8.0	Q3
SN74AHCT1G04DCKR	SC70	DCK	5	3000	180.0	9.2	2.3	2.55	1.2	4.0	8.0	Q3
SN74AHCT1G04DCKR	SC70	DCK	5	3000	178.0	9.2	2.4	2.4	1.22	4.0	8.0	Q3
SN74AHCT1G04DCKR	SC70	DCK	5	3000	178.0	9.0	2.4	2.5	1.2	4.0	8.0	Q3
SN74AHCT1G04DCKT	SC70	DCK	5	250	180.0	9.2	2.3	2.55	1.2	4.0	8.0	Q3
SN74AHCT1G04DCKT	SC70	DCK	5	250	178.0	9.2	2.4	2.4	1.22	4.0	8.0	Q3
SN74AHCT1G04DCKT	SC70	DCK	5	250	178.0	9.0	2.4	2.5	1.2	4.0	8.0	Q3

**TAPE AND REEL BOX DIMENSIONS**

\*All dimensions are nominal

Device	Package Type	Package Drawing	Pins	SPQ	Length (mm)	Width (mm)	Height (mm)
74AHCT1G04DBVRG4	SOT-23	DBV	5	3000	180.0	180.0	18.0
74AHCT1G04DBVTG4	SOT-23	DBV	5	250	180.0	180.0	18.0
SN74AHCT1G04DBVR	SOT-23	DBV	5	3000	180.0	180.0	18.0
SN74AHCT1G04DBVR	SOT-23	DBV	5	3000	180.0	180.0	18.0
SN74AHCT1G04DBVT	SOT-23	DBV	5	250	180.0	180.0	18.0
SN74AHCT1G04DBVT	SOT-23	DBV	5	250	180.0	180.0	18.0
SN74AHCT1G04DCKR	SC70	DCK	5	3000	205.0	200.0	33.0
SN74AHCT1G04DCKR	SC70	DCK	5	3000	180.0	180.0	18.0
SN74AHCT1G04DCKR	SC70	DCK	5	3000	180.0	180.0	18.0
SN74AHCT1G04DCKT	SC70	DCK	5	250	205.0	200.0	33.0
SN74AHCT1G04DCKT	SC70	DCK	5	250	180.0	180.0	18.0
SN74AHCT1G04DCKT	SC70	DCK	5	250	180.0	180.0	18.0

DBV (R-PDSO-G5)

PLASTIC SMALL-OUTLINE PACKAGE



- NOTES:
- A. All linear dimensions are in millimeters.
  - B. This drawing is subject to change without notice.
  - C. Body dimensions do not include mold flash or protrusion. Mold flash and protrusion shall not exceed 0.15 per side.
  - D. Falls within JEDEC MO-178 Variation AA.

DBV (R-PDSO-G5)

PLASTIC SMALL OUTLINE



- NOTES:
- A. All linear dimensions are in millimeters.
  - B. This drawing is subject to change without notice.
  - C. Customers should place a note on the circuit board fabrication drawing not to alter the center solder mask defined pad.
  - D. Publication IPC-7351 is recommended for alternate designs.
  - E. Laser cutting apertures with trapezoidal walls and also rounding corners will offer better paste release. Customers should contact their board assembly site for stencil design recommendations. Example stencil design based on a 50% volumetric metal load solder paste. Refer to IPC-7525 for other stencil recommendations.



DCK (R-PDSO-G5)

PLASTIC SMALL-OUTLINE PACKAGE

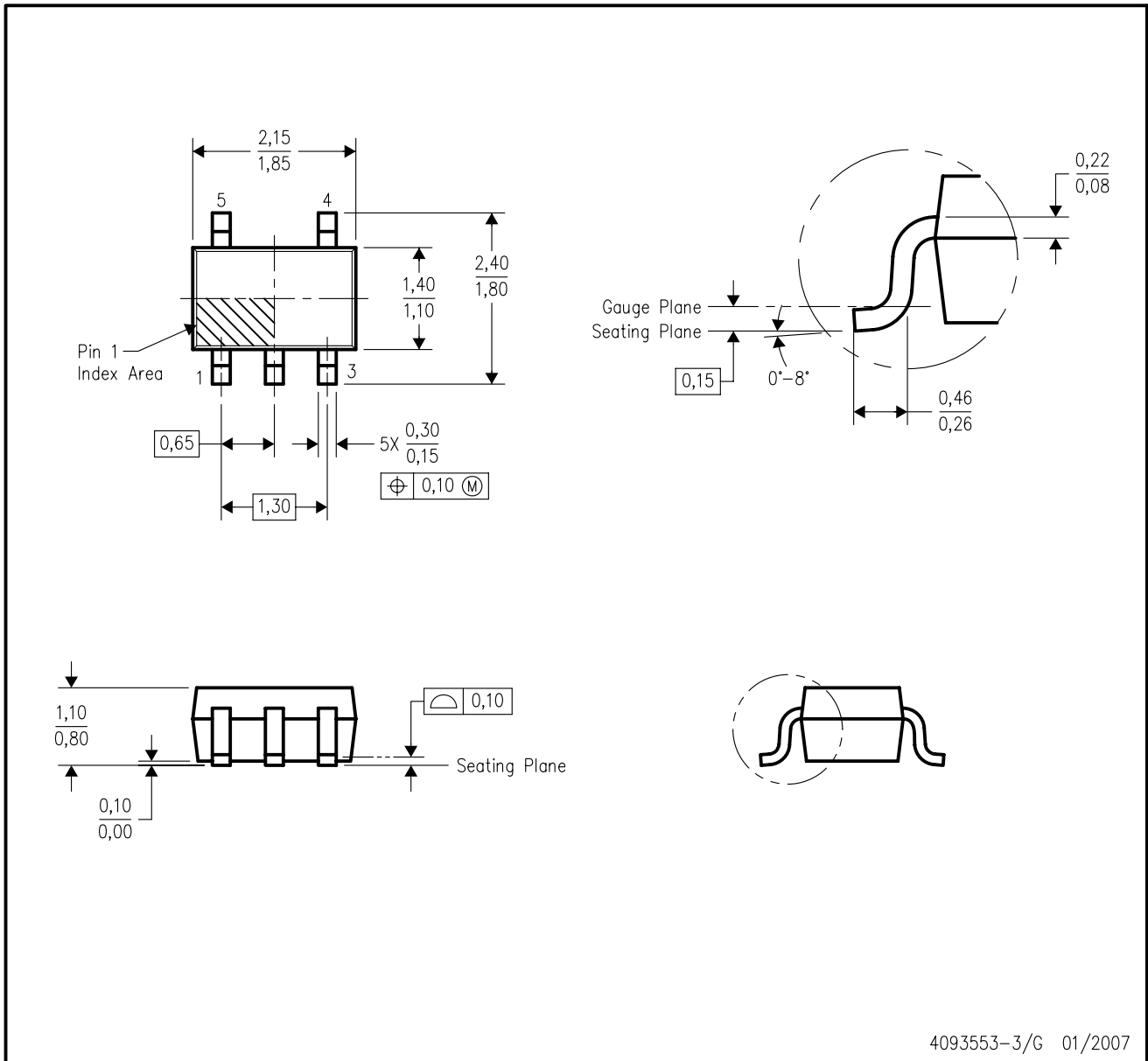

- NOTES:
- A. All linear dimensions are in millimeters.
  - B. This drawing is subject to change without notice.
  - C. Body dimensions do not include mold flash or protrusion. Mold flash and protrusion shall not exceed 0.15 per side.
  - D. Falls within JEDEC MO-203 variation AA.

DCK (R-PDSO-G5)

PLASTIC SMALL OUTLINE



- NOTES:
- A. All linear dimensions are in millimeters.
  - B. This drawing is subject to change without notice.
  - C. Customers should place a note on the circuit board fabrication drawing not to alter the center solder mask defined pad.
  - D. Publication IPC-7351 is recommended for alternate designs.
  - E. Laser cutting apertures with trapezoidal walls and also rounding corners will offer better paste release. Customers should contact their board assembly site for stencil design recommendations. Example stencil design based on a 50% volumetric metal load solder paste. Refer to IPC-7525 for other stencil recommendations.

## IMPORTANT NOTICE

Texas Instruments Incorporated (TI) reserves the right to make corrections, enhancements, improvements and other changes to its semiconductor products and services per JESD46, latest issue, and to discontinue any product or service per JESD48, latest issue. Buyers should obtain the latest relevant information before placing orders and should verify that such information is current and complete.

TI's published terms of sale for semiconductor products (<http://www.ti.com/sc/docs/stdterms.htm>) apply to the sale of packaged integrated circuit products that TI has qualified and released to market. Additional terms may apply to the use or sale of other types of TI products and services.

Reproduction of significant portions of TI information in TI data sheets is permissible only if reproduction is without alteration and is accompanied by all associated warranties, conditions, limitations, and notices. TI is not responsible or liable for such reproduced documentation. Information of third parties may be subject to additional restrictions. Resale of TI products or services with statements different from or beyond the parameters stated by TI for that product or service voids all express and any implied warranties for the associated TI product or service and is an unfair and deceptive business practice. TI is not responsible or liable for any such statements.

Buyers and others who are developing systems that incorporate TI products (collectively, "Designers") understand and agree that Designers remain responsible for using their independent analysis, evaluation and judgment in designing their applications and that Designers have full and exclusive responsibility to assure the safety of Designers' applications and compliance of their applications (and of all TI products used in or for Designers' applications) with all applicable regulations, laws and other applicable requirements. Designer represents that, with respect to their applications, Designer has all the necessary expertise to create and implement safeguards that (1) anticipate dangerous consequences of failures, (2) monitor failures and their consequences, and (3) lessen the likelihood of failures that might cause harm and take appropriate actions. Designer agrees that prior to using or distributing any applications that include TI products, Designer will thoroughly test such applications and the functionality of such TI products as used in such applications.

TI's provision of technical, application or other design advice, quality characterization, reliability data or other services or information, including, but not limited to, reference designs and materials relating to evaluation modules, (collectively, "TI Resources") are intended to assist designers who are developing applications that incorporate TI products; by downloading, accessing or using TI Resources in any way, Designer (individually or, if Designer is acting on behalf of a company, Designer's company) agrees to use any particular TI Resource solely for this purpose and subject to the terms of this Notice.

TI's provision of TI Resources does not expand or otherwise alter TI's applicable published warranties or warranty disclaimers for TI products, and no additional obligations or liabilities arise from TI providing such TI Resources. TI reserves the right to make corrections, enhancements, improvements and other changes to its TI Resources. TI has not conducted any testing other than that specifically described in the published documentation for a particular TI Resource.

Designer is authorized to use, copy and modify any individual TI Resource only in connection with the development of applications that include the TI product(s) identified in such TI Resource. NO OTHER LICENSE, EXPRESS OR IMPLIED, BY ESTOPPEL OR OTHERWISE TO ANY OTHER TI INTELLECTUAL PROPERTY RIGHT, AND NO LICENSE TO ANY TECHNOLOGY OR INTELLECTUAL PROPERTY RIGHT OF TI OR ANY THIRD PARTY IS GRANTED HEREIN, including but not limited to any patent right, copyright, mask work right, or other intellectual property right relating to any combination, machine, or process in which TI products or services are used. Information regarding or referencing third-party products or services does not constitute a license to use such products or services, or a warranty or endorsement thereof. Use of TI Resources may require a license from a third party under the patents or other intellectual property of the third party, or a license from TI under the patents or other intellectual property of TI.

TI RESOURCES ARE PROVIDED "AS IS" AND WITH ALL FAULTS. TI DISCLAIMS ALL OTHER WARRANTIES OR REPRESENTATIONS, EXPRESS OR IMPLIED, REGARDING RESOURCES OR USE THEREOF, INCLUDING BUT NOT LIMITED TO ACCURACY OR COMPLETENESS, TITLE, ANY EPIDEMIC FAILURE WARRANTY AND ANY IMPLIED WARRANTIES OF MERCHANTABILITY, FITNESS FOR A PARTICULAR PURPOSE, AND NON-INFRINGEMENT OF ANY THIRD PARTY INTELLECTUAL PROPERTY RIGHTS. TI SHALL NOT BE LIABLE FOR AND SHALL NOT DEFEND OR INDEMNIFY DESIGNER AGAINST ANY CLAIM, INCLUDING BUT NOT LIMITED TO ANY INFRINGEMENT CLAIM THAT RELATES TO OR IS BASED ON ANY COMBINATION OF PRODUCTS EVEN IF DESCRIBED IN TI RESOURCES OR OTHERWISE. IN NO EVENT SHALL TI BE LIABLE FOR ANY ACTUAL, DIRECT, SPECIAL, COLLATERAL, INDIRECT, PUNITIVE, INCIDENTAL, CONSEQUENTIAL OR EXEMPLARY DAMAGES IN CONNECTION WITH OR ARISING OUT OF TI RESOURCES OR USE THEREOF, AND REGARDLESS OF WHETHER TI HAS BEEN ADVISED OF THE POSSIBILITY OF SUCH DAMAGES.

Unless TI has explicitly designated an individual product as meeting the requirements of a particular industry standard (e.g., ISO/TS 16949 and ISO 26262), TI is not responsible for any failure to meet such industry standard requirements.

Where TI specifically promotes products as facilitating functional safety or as compliant with industry functional safety standards, such products are intended to help enable customers to design and create their own applications that meet applicable functional safety standards and requirements. Using products in an application does not by itself establish any safety features in the application. Designers must ensure compliance with safety-related requirements and standards applicable to their applications. Designer may not use any TI products in life-critical medical equipment unless authorized officers of the parties have executed a special contract specifically governing such use. Life-critical medical equipment is medical equipment where failure of such equipment would cause serious bodily injury or death (e.g., life support, pacemakers, defibrillators, heart pumps, neurostimulators, and implantables). Such equipment includes, without limitation, all medical devices identified by the U.S. Food and Drug Administration as Class III devices and equivalent classifications outside the U.S.

TI may expressly designate certain products as completing a particular qualification (e.g., Q100, Military Grade, or Enhanced Product). Designers agree that it has the necessary expertise to select the product with the appropriate qualification designation for their applications and that proper product selection is at Designers' own risk. Designers are solely responsible for compliance with all legal and regulatory requirements in connection with such selection.

Designer will fully indemnify TI and its representatives against any damages, costs, losses, and/or liabilities arising out of Designer's non-compliance with the terms and provisions of this Notice.