

## PLED-150W Series Flicker-Free LED Drivers

select **SYNC**  
classic

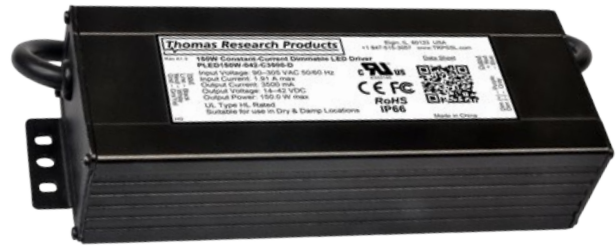

### Electrical Specifications

Input Voltage Range:	100-277 Vac Nom. (90-305 V Min/Max)
Input Over-Voltage:	Can endure 320Vac for 48 Hrs, 350Vac for 2 Hrs
Frequency:	50/60 Hz Nom. (47-63 Hz Min/Max)
Power Factor:	>0.90 @ > 70% load, 120-277V
Inrush Current:	<60.0 Amps max @ 277Vac, cold start, full load
Input Current:	0.75 Amps max @ 230Vac, 1.41 A max @ 120Vac
Maximum Power:	150W
Current Accuracy:	± 3%
Load Regulation:	± 4%
THD:	≤ 20% @ > 70% load, 120-277V
Ripple & Noise: (Vpk-pk)	5% Vo max @ 20 MHz BW, Full load output in parallel with 0.1 µF ceramic & 10 µF Electrolytic
Ripple: (Ipk-pk)	5% Io max @ 20 MHz BW, Full load output in parallel with 0.1 µF ceramic & 10 µF Electrolytic. 120 Hz component (Flicker Free)
Start-up Time:	150mS typical @ Full Load, 120Vac/60Hz (1000mS max)
Leakage Current:	0.68 mA max @ 120Vac, 0.75 mA max @ 277Vac
Hold-up Time:	30mS typical @ Full Load, 277Vac

### Protections

Over-voltage	Over-Voltage, Over-Current
Short Circuit	Auto Recovery

### Environmental Specifications

Maximum Case Temp.	90°C
Minimum Starting Temp:	-30°C
UL Type TL Rating:	Non-Class 2: 90/82°C
Storage Temperature:	-40°C to +85°C
Humidity:	5% to 95%
Cooling:	Convection
Vibration Frequency:	5 to 55 Hz/2g, 30 minutes
MTBF:	260,000 Hours at full load and 40°C ambient conditions per MIL-217F Notice 2
EMC:	FCC 47CFR Part 15 Class B compliant
Impact Resistance:	1g/s
Weight:	24.4 oz (690 grams)

### Ordering Options:

- D: 0-10V & Resistance dimmable models dim 100-10%. Two extra wires on the output side (+Purple/-Gray). Compatible with most quality 0-10V wall dimmers. See page 3.
- D3: 3-wire dimmable models dim 100-10%. Three extra wires on the output side (Yellow/Purple/Gray). Compatible with potentiometer dimming. See page 3.
- Total Power: 150 Watts
- Constant Current & Constant Voltage with Isolation
- Input Voltage: 100-277 Vac Nom.
- UL Dry & Damp Location Rated
- IP66 & NEMA6
- UL Type HL Rated for Hazardous Locations
- UL Sign Components Manual (S.A.M. Models)
- Black Magic Thermal Advantage™ Aluminum Housing

### Constant Current Models

Model	Output Current (mA ±5%)	Output Voltage Range (Vdc)	Max Output Power (W)	Typical Efficiency
PLED150W-428-C0350-XX	350	142-428	150	92%
PLED150W-333-C0450-XX	450	111-333	150	92%
PLED150W-283-C0530-XX	530	95-283	150	91%
PLED150W-214-C0700-XX	700	72-214	150	91%
PLED150W-142-C1050-XX	1050	48-142	150	91%
PLED150W-107-C1400-XX	1400	36-107	150	91%
PLED150W-085-C1750-XX	1750	29-85	150	90%
PLED150W-071-C2100-XX	2100	24-71	150	90%
PLED150W-061-C2450-XX	2450	21-61	150	90%
PLED150W-053-C2800-XX	2800	18-53	150	90%
PLED150W-048-C3150-XX	3150	16-48	150	89%
PLED150W-042-C3500-XX	3500	14-42	150	89%
PLED150W-035-C4200-XX	4200	12-35	150	89%
PLED150W-030-C4900-XX	4900	10-30	150	88%
PLED150W-024-C6250-XX	6250	8-24	150	88%

-XX indicates dimming options are available. See options at left. Blank = fixed current output

### Constant Voltage Models

Model	Output Voltage (Vdc ±5%)	Output Current Range (mA)	Max Output Power (W)	Typical Efficiency
PLED150W-024	24	1563-6250	150	88%
PLED150W-030	30	1225-4900	150	88%
PLED150W-035	35	1050-4200	150	89%
PLED150W-042	42	875-3500	150	89%
PLED150W-048	48	788-3150	150	89%
PLED150W-053	53	700-2800	150	90%
PLED150W-061	61	613-2450	150	90%
PLED150W-071	71	525-2100	150	90%
PLED150W-085	85	438-1750	150	90%
PLED150W-107	107	350-1400	150	91%
PLED150W-142	142	263-1050	150	91%
PLED150W-214	214	175-700	150	91%
PLED150W-283	283	133-530	150	91%
PLED150W-333	333	113-450	150	92%
PLED150W-428	428	88-350	150	92%

• Indicates S.A.M.

Safety Cert.	Standard
UL/CUL	UL8750 & CAN/CSA-22.2 No. 250.13-12, UL1012/CSA-C22.2 No.107.1
CE	EN 61347-1, EN61347-2-13
EMC Standard	Notes
FCC, 47CFR Part 15	Class B
EN 55015	Limits and methods of measurement of radio disturbance characteristics of electrical lighting and similar equipment.
EN 61000-3-2	Part 3-2: Limits for harmonic current emissions Class C, >80% Rated Power
EN 61000-3-3	Part 3-3: Limitation of voltage changes, voltage fluctuations and flicker.
EN 61000-4-5	Part 4-5: Surge Immunity test, 2 kV L-N, 4 kV L-G & N-G



**Dimensions**

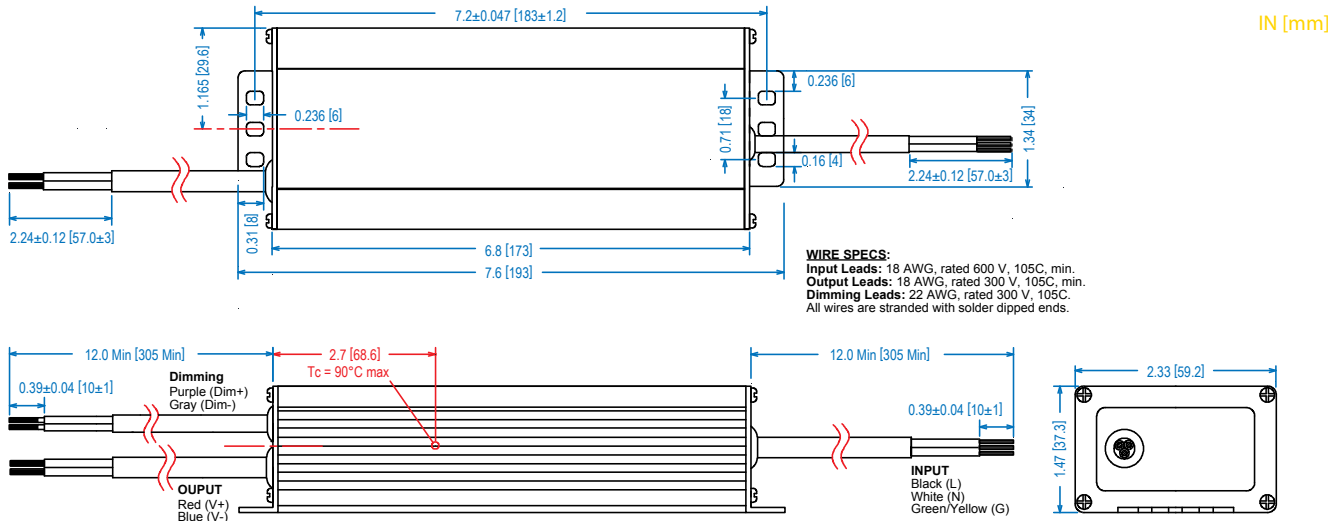

**Power Characteristics**

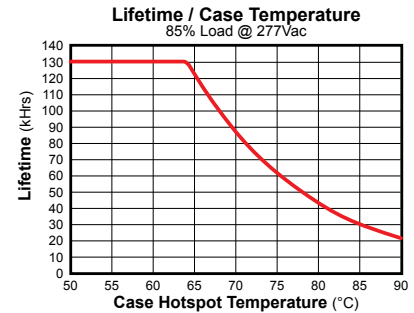
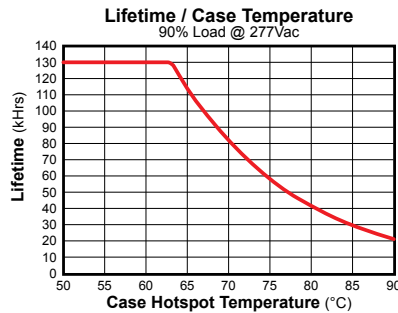
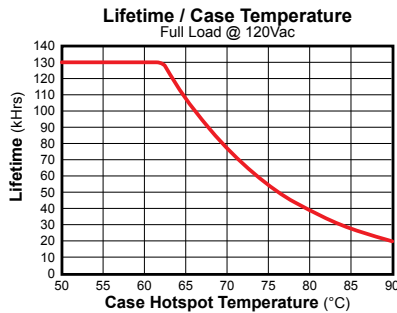
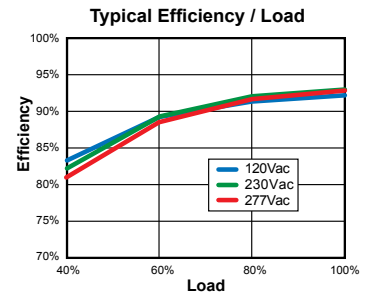
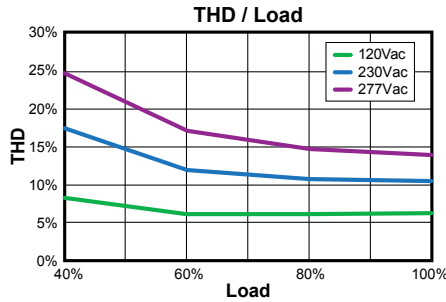
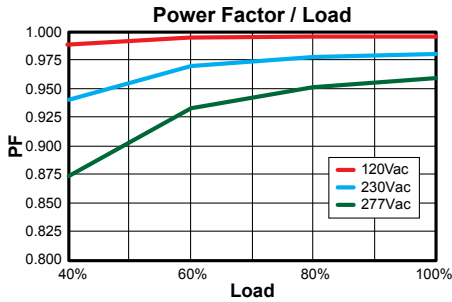

**UL Conditions of Acceptability**

See website for additional information

*Note: The area under the life-temperature curve represents where the driver has highly reliable operation within specification. Driver performance may drift out of published specifications as the hours of operation exceed the curve at a given temperature. Higher operating temperatures increase the chances of a failure to function. Other electrical, mechanical and environmental factors affect driver lifetime but are not represented in this calculation.*

### "-D" Option: 0-10VDC and Resistance Dimming

Parameters	Minimum	Typical	Maximum
10V Output, Yellow Wire	9.2V	10.0V	10.8V
Source Current out of Aux Yellow Wire	—	—	10mA
Absolute Voltage Range on 0-10V (+) Purple Wire	-2.0V	—	+15V
Source Current out of 0-10V Purple Wire	0mA	—	2mA

#### Typical Dimming Circuit

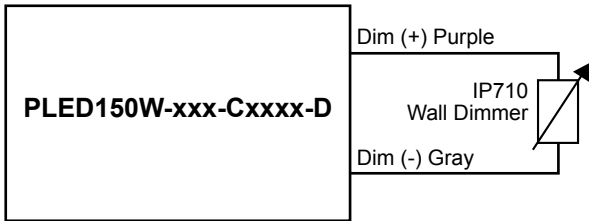

(Dimmer must be current-sink type control)

#### 3-Wire Dimming Typical Circuit

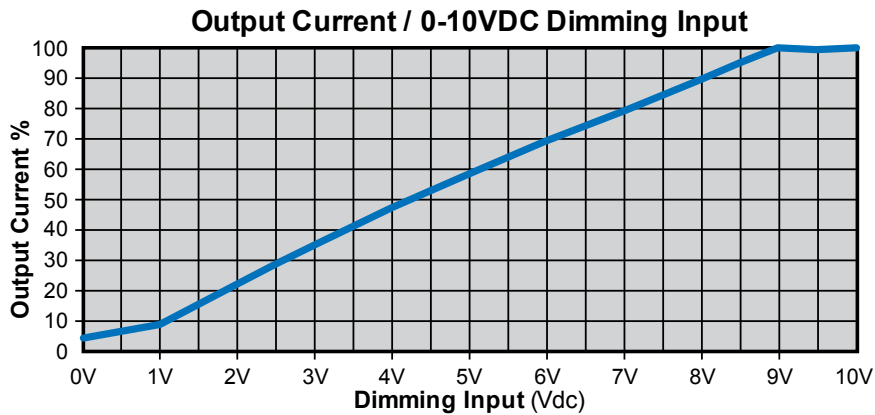
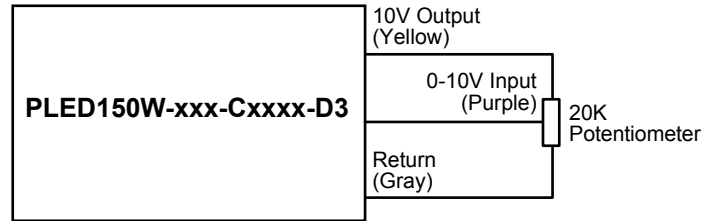

#### Notes:

- 0-10V dimmable version comes with an extra two wires +Purple/-Gray on the output side.
- Compatible with most 0-10V Wall Slide dimmers and direct 0-10V analog signal. Recommended dimmer is Leviton IP710 or equivalent
- 0-10V dimmable version is not intended to dim to zero (off). Will be out <10% @ Vdim <1.0V
- 0-10V dimmable version output will be 100% with Purple/Gray open and minimum with Purple/Gray Shorted.