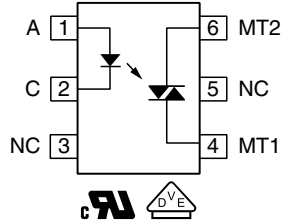
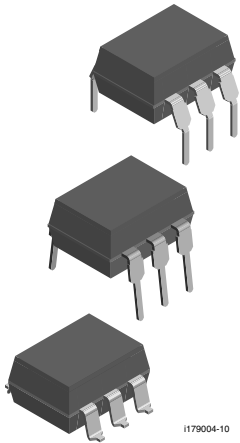




# Optocoupler, Phototriac Output, Non-Zero Crossing



## FEATURES

- $I_{RMS} = 300\text{ mA}$
- High static  $dV/dt < 10\,000\text{ V}/\mu\text{s}$
- Electrically insulated between input and output circuit
- Microcomputer compatible - very low trigger current
- Trigger current
  - ( $I_{FT} < 1.2\text{ mA}$ ) BRT12F
  - ( $I_{FT} < 2\text{ mA}$ ) BRT11H, BRT12H, BRT13H
  - ( $I_{FT} < 3\text{ mA}$ ) BRT11M, BRT12M, BRT13M
- Non-zero voltage detectors high input sensitivity
- Compliant to RoHS Directive 2002/95/EC and in accordance to WEEE 2002/96/EC



**RoHS**  
COMPLIANT

## DESCRIPTION

The BRT11, BRT12, and BRT13 product family consists of AC optocouplers non-zero voltage detectors consisting of two electrically insulated lateral power ICs which integrate a thyristor system, a photo detector and noise suppression at the output and an IR GaAs diode input.

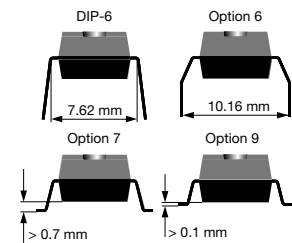
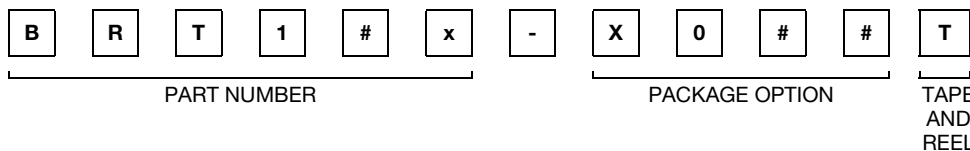
## APPLICATIONS

- Industrial controls
- Office equipment
- Consumer appliances

## AGENCY APPROVALS

- UL 1577, file no. E52744 system code H
- DIN EN 60747-5-2 (VDE 0844)/DIN EN 60747-5-5 (pending) available with option 1
- CQC

## ORDERING INFORMATION



| AGENCY CERTIFIED/PACKAGE | $V_{DRM}\text{ (V)}$   |                        |                             |                             |                        |                             |                        |
|--------------------------|------------------------|------------------------|-----------------------------|-----------------------------|------------------------|-----------------------------|------------------------|
|                          | $\leq 400$             |                        | $\leq 600$                  |                             |                        | $\leq 800$                  |                        |
| UL                       | $I_{FT} = 2\text{ mA}$ | $I_{FT} = 3\text{ mA}$ | $I_{FT} = 1.2\text{ mA}$    | $I_{FT} = 2\text{ mA}$      | $I_{FT} = 3\text{ mA}$ | $I_{FT} = 2\text{ mA}$      | $I_{FT} = 3\text{ mA}$ |
| DIP-6                    | BRT11H                 | BRT11M                 | BRT12F                      | BRT12H                      | BRT12M                 | BRT13H                      | BRT13M                 |
| DIP-6, 400 mil, option 6 | -                      | -                      | BRT12F-X006                 | BRT12H-X006                 | -                      | BRT13H-X006                 | -                      |
| SMD-6, option 7          | -                      | -                      | BRT12F-X007T <sup>(1)</sup> | BRT12H-X007T <sup>(1)</sup> | -                      | BRT13H-X007T <sup>(1)</sup> | -                      |
| SMD-6, option 9          | -                      | -                      | -                           | BRT12H-X009T                | -                      | BRT13H-X009T                | -                      |
| UL, VDE                  | $I_{FT} = 2\text{ mA}$ | $I_{FT} = 3\text{ mA}$ | $I_{FT} = 1.2\text{ mA}$    | $I_{FT} = 2\text{ mA}$      | $I_{FT} = 3\text{ mA}$ | $I_{FT} = 2\text{ mA}$      | $I_{FT} = 3\text{ mA}$ |
| DIP-6                    | -                      | -                      | -                           | BRT12H-X001                 | BRT12M-X001            | -                           | -                      |
| DIP-6, option 6          | -                      | -                      | BRT12F-X016                 | BRT12H-X016                 | BRT12M-X016            | BRT13H-X016                 | -                      |
| SMD-6, option 7          | -                      | -                      | -                           | -                           | -                      | BRT13H-X017T <sup>(1)</sup> | -                      |

### Note

<sup>(1)</sup> Also available in tube, do not put T on the end.



| <b>ABSOLUTE MAXIMUM RATINGS</b> ( $T_{amb} = 25\text{ }^{\circ}\text{C}$ , unless otherwise specified)           |   |       |            |                |                    |
|--|---|-------|------------|----------------|--------------------|
| PARAMETER  | TEST CONDITION  | PART  | SYMBOL     | VALUE          | UNIT               |
| <b>INPUT</b>   |   |       |            |                |                    |
| Reverse voltage  |   |       | $V_R$      | 6              | V                  |
| Forward current  |   |       | $I_F$      | 20             | mA                 |
| Surge forward current  |   |       | $I_{FSM}$  | 1.5            | A                  |
| Power dissipation  | $t \leq 10\text{ }\mu\text{s}$                                    |       | $P_{diss}$ | 30             | mW                 |
| <b>OUTPUT</b>  |   |       |            |                |                    |
| Repetitive peak off-state voltage  |   | BRT11 | $V_{DRM}$  | 400            | V                  |
|  |   | BRT12 | $V_{DRM}$  | 600            | V                  |
|  |   | BRT13 | $V_{DRM}$  | 800            | V                  |
| RMS on-state current   |   |       | $I_{TRMS}$ | 300            | mA                 |
| Single cycle surge current   | 50 Hz   |       | $I_{TSM}$  | 3              | A                  |
| Power dissipation  |   |       | $P_{diss}$ | 600            | mW                 |
| <b>COUPLER</b>   |   |       |            |                |                    |
| Maximum power dissipation  |   |       | $P_{tot}$  | 630            | mW                 |
| Isolation test voltage<br>(between emitter and detector, climate per DIN 500414, part 2, Nov. 74) <sup>(1)</sup> |   |       | $V_{ISO}$  | 5300           | $V_{RMS}$          |
| Reference voltage in accordance with VDE 0110 b  |   |       | $V_{ref}$  | 500            | $V_{RMS}$          |
| Reference voltage in accordance with VDE 0110 b (insulation group C)   |   |       | $V_{ref}$  | 600            | $V_{DC}$           |
| Creepage distance  |   |       |            | $\geq 7.2$     | mm                 |
| Clearance distance   |   |       |            | $\geq 7.2$     | mm                 |
| Comparative tracking index per DIN IEC 112/VDE 0303 part 1   | group IIIa according to DIN VDE 0109                              |       | CTI        | $\geq 175$     |                    |
| Isolation resistance   | $V_{IO} = 500\text{ V}$ , $T_{amb} = 25\text{ }^{\circ}\text{C}$  |       | $R_{IO}$   | $\geq 10^{12}$ | $\Omega$           |
|  | $V_{IO} = 500\text{ V}$ , $T_{amb} = 100\text{ }^{\circ}\text{C}$ |       | $R_{IO}$   | $\geq 10^{11}$ | $\Omega$           |
| Storage temperature range  |   |       | $T_{stg}$  | - 40 to + 150  | $^{\circ}\text{C}$ |
| Ambient temperature range  |   |       | $T_{amb}$  | - 40 to + 100  | $^{\circ}\text{C}$ |

**Notes**

- Stresses in excess of the absolute maximum ratings can cause permanent damage to the device. Functional operation of the device is not implied at these or any other conditions in excess of those given in the operational sections of this document. Exposure to absolute maximum ratings for extended periods of the time can adversely affect reliability.

<sup>(1)</sup> Test AC voltage in accordance with DIN 57883, June 1980.

| <b>ELECTRICAL CHARACTERISTICS</b> ( $T_{amb} = 25\text{ }^{\circ}\text{C}$ , unless otherwise specified) |   |       |                            |      |      |      |                                |
|--|---|-------|----------------------------|------|------|------|--------------------------------|
| PARAMETER  | TEST CONDITION  | PART  | SYMBOL                     | MIN. | TYP. | MAX. | UNIT                           |
| <b>INPUT</b>   |   |       |                            |      |      |      |                                |
| Forward voltage  | $I_F = 10\text{ mA}$  |       | $V_F$                      |      | 1.1  | 1.35 | V                              |
| Reverse current  | $V_R = 6\text{ V}$  |       | $I_R$                      |      |      | 10   | $\mu\text{A}$                  |
| Thermal resistance, junction to ambient <sup>(1)</sup>   |   |       | $R_{thJA}$                 |      |      | 750  | $^{\circ}\text{C/W}$           |
| <b>OUTPUT</b>  |   |       |                            |      |      |      |                                |
| Peak off-state voltage   | $I_{D(RMS)} = 100\text{ }\mu\text{A}$   | BRT11 | $V_{DM}$                   |      | 400  |      | $\mu\text{A}$                  |
|  |   | BRT12 |                            |      | 600  |      | $\mu\text{A}$                  |
|  |   | BRT13 |                            |      | 800  |      | $\mu\text{A}$                  |
| Off-state current  | $T_C = 80\text{ }^{\circ}\text{C}$ , $V_{DRM}$  |       | $I_D$                      |      | 0.5  | 100  | $\mu\text{A}$                  |
| On-state voltage   | $I_T = 300\text{ mA}$   |       | $V_T$                      |      |      | 2.3  | V                              |
| Pulse current  | $t_p \leq 5\text{ }\mu\text{s}$ , $f = 100\text{ Hz}$ ,<br>$di_{tp}/dt \leq 8\text{ A}/\mu\text{s}$     |       | $I_{tp}$                   |      |      | 2    | A                              |
| Critical rate of rise of off-state voltage   | $V_D = 0.67\text{ }V_{DRM}$ , $T_j = 25\text{ }^{\circ}\text{C}$  |       | $dV/dt_{cr}$               | 10   |      |      | $\text{kV}/\mu\text{s}$        |
|  | $V_D = 0.67\text{ }V_{DRM}$ , $T_j = 80\text{ }^{\circ}\text{C}$  |       | $dV/dt_{cr}$               | 5    |      |      | $\text{kV}/\mu\text{s}$        |
| Critical rate of rise of voltage at current commutation  | $V_D = 0.67\text{ }V_{DRM}$ , $T_j = 25\text{ }^{\circ}\text{C}$ ,<br>$di/dt_{crq} \leq 15\text{ A/ms}$ |       | $dV/dt_{crq}$              | 10   |      |      | $\text{kV}/\mu\text{s}$        |
|  | $V_D = 0.67\text{ }V_{DRM}$ , $T_j = 80\text{ }^{\circ}\text{C}$ ,<br>$di/dt_{crq} \leq 15\text{ A/ms}$ |       | $dV/dt_{crq}$              | 5    |      |      | $\text{kV}/\mu\text{s}$        |
| Critical rate of rise of on-state at current   |   |       | $di/dt_{cr}$               | 8    |      |      | $\text{A}/\mu\text{s}$         |
| Holding current  | $V_D = 10\text{ V}$   |       | $I_H$                      |      | 80   | 500  | $\mu\text{A}$                  |
| Thermal resistance, junction to ambient  |   |       | $R_{thJA}$                 |      |      | 125  | $^{\circ}\text{C/W}$           |
| <b>COUPLER</b>   |   |       |                            |      |      |      |                                |
| Trigger current  | $V_D = 10\text{ V}$ , F - versions  |       | $I_{FT}$                   |      |      | 1.2  | mA                             |
|  | $V_D = 10\text{ V}$ , H - versions  |       | $I_{FT}$                   | 0.4  |      | 2    | mA                             |
|  | $V_D = 10\text{ V}$ , M - versions  |       | $I_{FT}$                   | 0.8  |      | 3    | mA                             |
| Trigger current temperature gradient   |   |       | $\Delta I_{FT}/\Delta T_j$ |      | 7    | 14   | $\mu\text{A}/^{\circ}\text{C}$ |
| Capacitance (input to output)  | $f = 1\text{ MHz}$ , $V_R = 0\text{ V}$   |       | $C_{IO}$                   |      |      | 2    | pF                             |

**Notes**

- Minimum and maximum values are testing requirements. Typical values are characteristics of the device and are the result of engineering evaluation. Typical values are for information only and are not part of the testing requirements.
- (1) Static air, SITAC soldered in PCB or base plate.

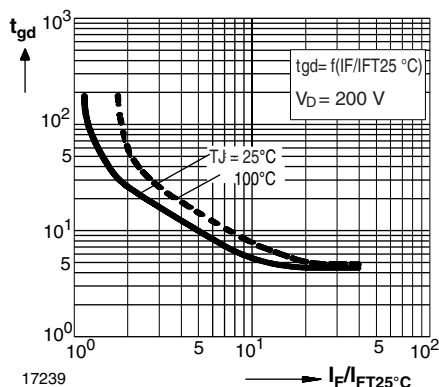
**TYPICAL CHARACTERISTICS** ( $T_{amb} = 25\text{ }^{\circ}\text{C}$ , unless otherwise specified)


Fig. 1 - Typical Trigger Delay Time

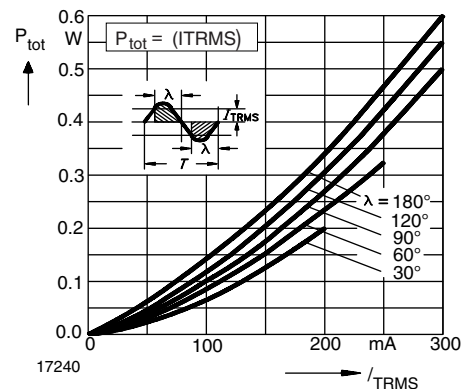


Fig. 2 - Power Dissipation 60 Hz to 60 Hz Line Operation

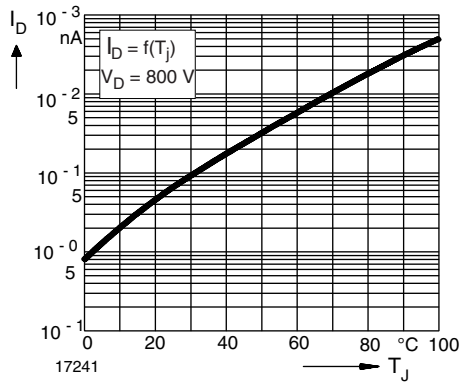


Fig. 3 - Typical Off-State Current

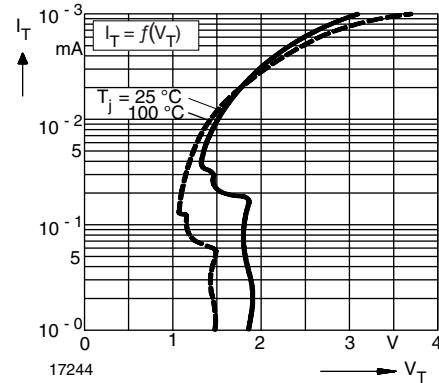


Fig. 6 - Typical Output Characteristics

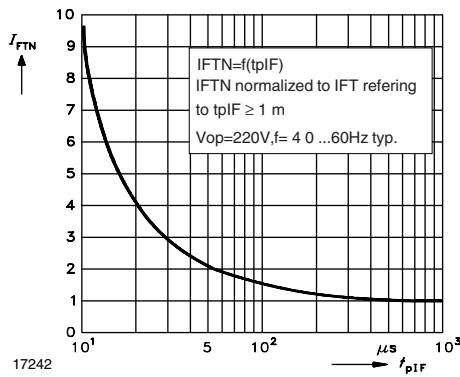


Fig. 4 - Pulse Trigger Current

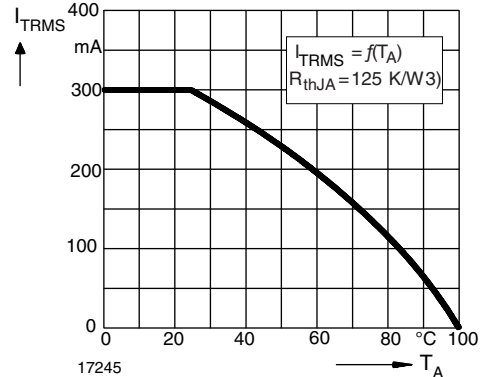


Fig. 7 - Current Reduction

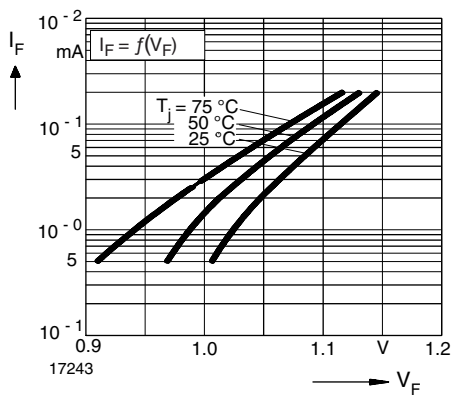


Fig. 5 - Typical Input Characteristics

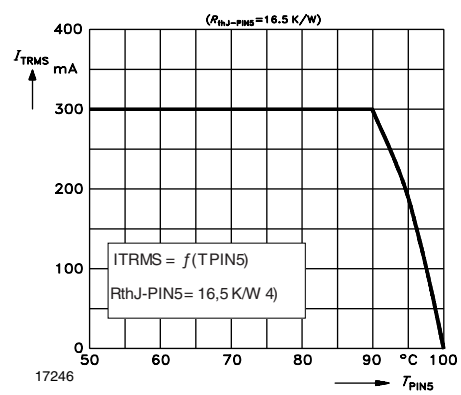
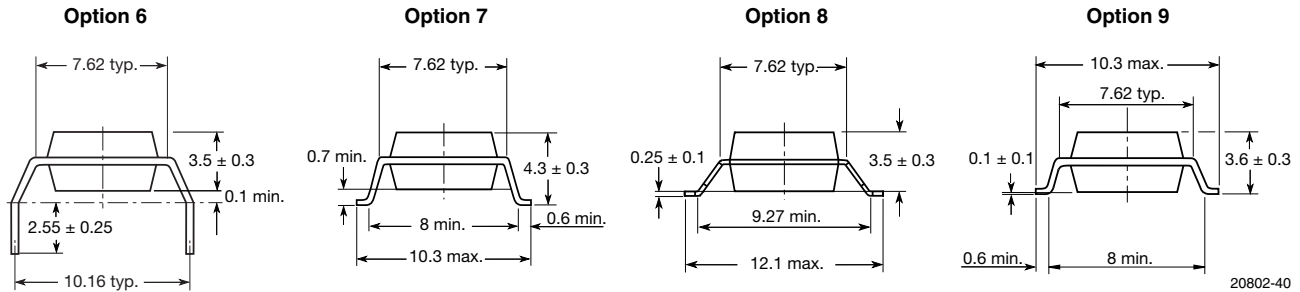
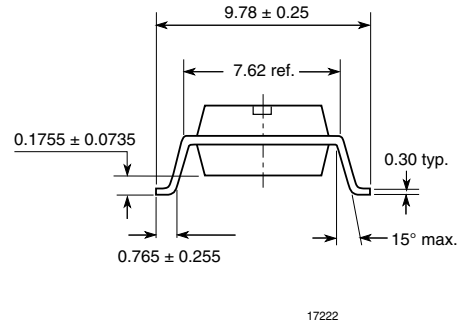
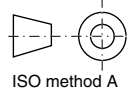
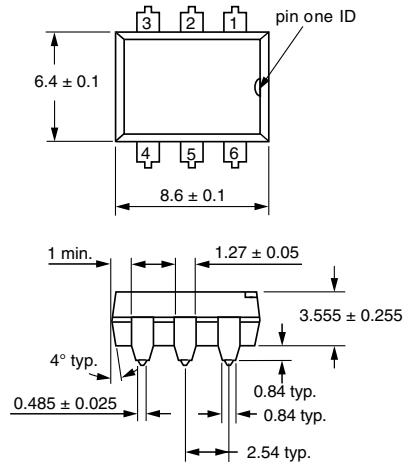


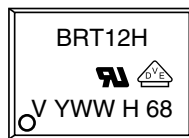
Fig. 8 - Current Reduction



### PACKAGE DIMENSIONS in millimeters



### PACKAGE MARKING (example)



#### Notes

- Only options 1, and 7 are reflected in the package marking.
- The VDE logo is only marked on option 1 parts.
- Tape and reel suffix (T) is not part of the package marking.



## **Disclaimer**

ALL PRODUCT, PRODUCT SPECIFICATIONS AND DATA ARE SUBJECT TO CHANGE WITHOUT NOTICE TO IMPROVE RELIABILITY, FUNCTION OR DESIGN OR OTHERWISE.

Vishay Intertechnology, Inc., its affiliates, agents, and employees, and all persons acting on its or their behalf (collectively, "Vishay"), disclaim any and all liability for any errors, inaccuracies or incompleteness contained in any datasheet or in any other disclosure relating to any product.

Vishay makes no warranty, representation or guarantee regarding the suitability of the products for any particular purpose or the continuing production of any product. To the maximum extent permitted by applicable law, Vishay disclaims (i) any and all liability arising out of the application or use of any product, (ii) any and all liability, including without limitation special, consequential or incidental damages, and (iii) any and all implied warranties, including warranties of fitness for particular purpose, non-infringement and merchantability.

Statements regarding the suitability of products for certain types of applications are based on Vishay's knowledge of typical requirements that are often placed on Vishay products in generic applications. Such statements are not binding statements about the suitability of products for a particular application. It is the customer's responsibility to validate that a particular product with the properties described in the product specification is suitable for use in a particular application. Parameters provided in datasheets and / or specifications may vary in different applications and performance may vary over time. All operating parameters, including typical parameters, must be validated for each customer application by the customer's technical experts. Product specifications do not expand or otherwise modify Vishay's terms and conditions of purchase, including but not limited to the warranty expressed therein.

Except as expressly indicated in writing, Vishay products are not designed for use in medical, life-saving, or life-sustaining applications or for any other application in which the failure of the Vishay product could result in personal injury or death. Customers using or selling Vishay products not expressly indicated for use in such applications do so at their own risk. Please contact authorized Vishay personnel to obtain written terms and conditions regarding products designed for such applications.

No license, express or implied, by estoppel or otherwise, to any intellectual property rights is granted by this document or by any conduct of Vishay. Product names and markings noted herein may be trademarks of their respective owners.