

AC Filter for PCB Mounting Cost Optimized

Standard- or Medical-Filter



Description

- Line filter in standard and medical version
- 1-stage
- standard attenuation

Approvals

- Approval Reference Type: FPP2
- VDE Certificate Number: 40004673
- UL File Number: E72928

Characteristics

- Cost-saving plastic housing
- Designed for standard applications
- Protection against interference voltage from the mains
- Possible interferences generated in the equipment are strongly attenuated
- For standard applications
- Suitable for use in equipment according to IEC/UL 60950

Other versions on request

- Version with wire connection
- Medical version M80

References

Alternative: Standard version

Weblinks

[pdf datasheet](#), [html-datasheet](#), [General Product Information](#), [Approvals](#), [CE declaration of conformity](#), [RoHS](#), [CHINA-RoHS](#), [REACH](#), [Distributor-Stock-Check](#), [Detailed request for product](#), [Microsite](#)

Technical Data

Ratings IEC	0.6 - 6 A @ Ta 40 °C / 250 VAC; 50 Hz
Ratings UL/CSA	0.6 - 6 A @ Ta 40 °C / 125 VAC; 60 Hz
Leakage Current	standard < 0.25 mA (250 V / 60 Hz) medical < 5 µA (250 V / 60 Hz)
Dielectric Strength	> 1.7 kVDC between L-N > 2.7 kVDC between L/N-PE Test voltage (2 sec)
Allowable Operation Temperature	-25 °C to 85 °C
Climatic Category	25/085/21 acc. to IEC 60068-1
Protection Class	Suitable for appliances with protection class I acc. to IEC 61140
Terminal	For PCB mounting, tin-plated
Material: Housing	Thermoplastic, black, UL 94V-0

Line Filter	Standard and Medical Version, IEC 60939, UL 1283, CSA C22.2 no. 8 Technical Details
MTBF	> 200'000h acc. to MIL-HB-217 F

Detailed information on product approvals, code requirements, usage instructions and detailed test conditions can be looked up in [General Product Information](#)

Dimension [mm]

Case 13P

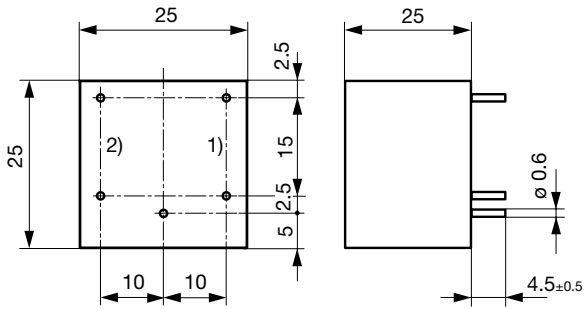

Case 18P

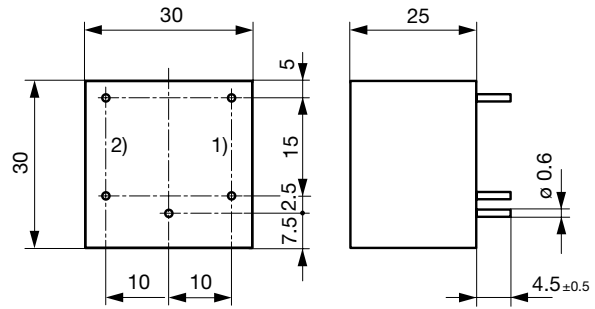

Case 24P

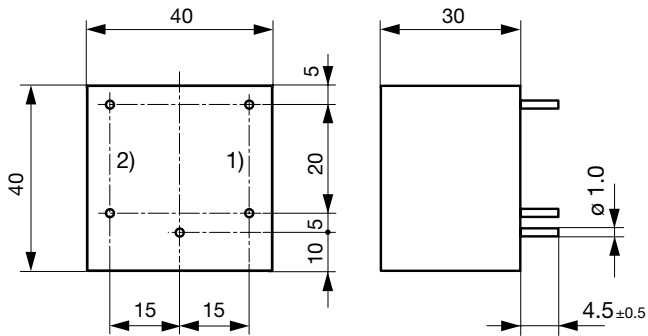

- 1) Line
- 2) Load

Diagrams

S1 standard version

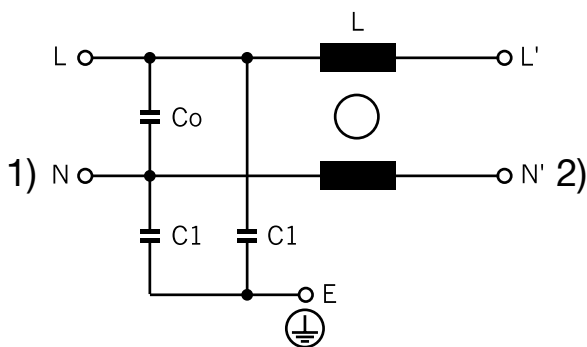

- 1) Line
- 2) Load

S2 medical version

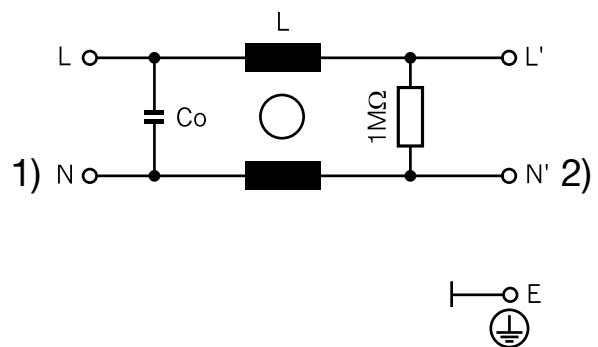

- 1) Line
- 2) Load

Attenuation Loss

--- 50Ω differential mode ___ 50Ω common mode

Standard version

0.6 A

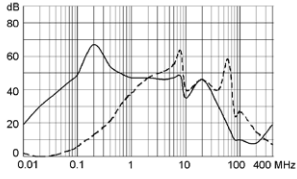

1 A

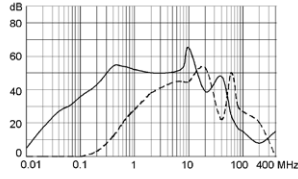

2 A

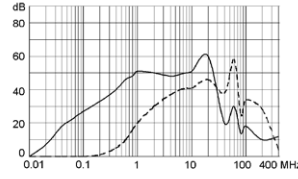

4 A

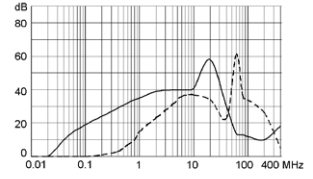

6 A

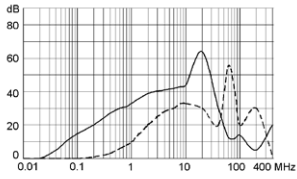

0.7 A

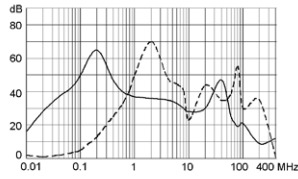

1 A

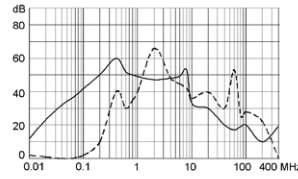

2 A

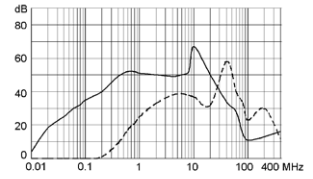

3 A

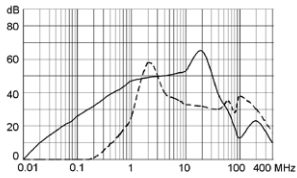

1 A

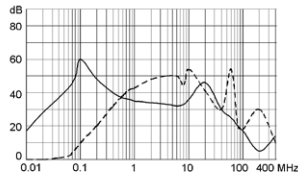

3 A

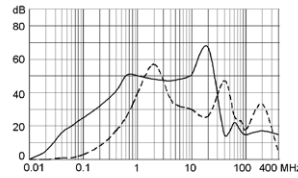

Medical version (M5)

0.6 A

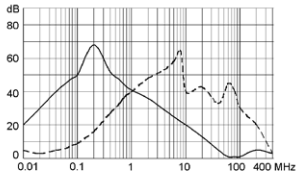

1 A

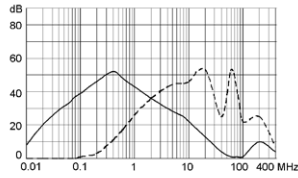

2 A

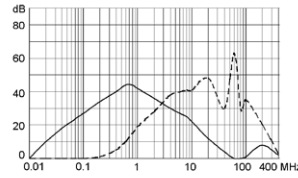

4 A

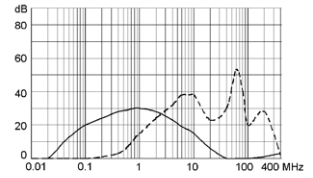

6 A

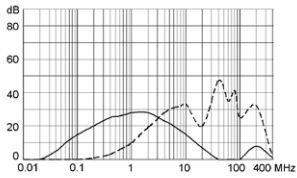

0.7 A

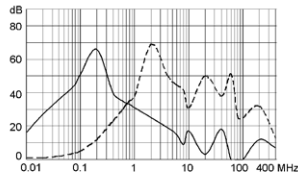

1 A

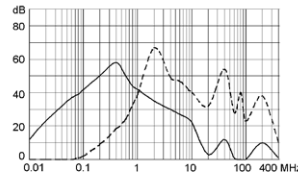

2 A

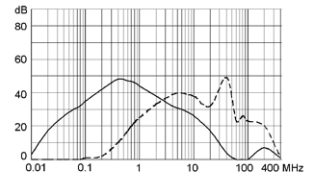

3 A

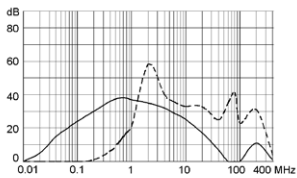

1 A

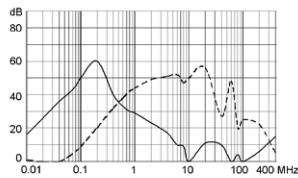

3 A

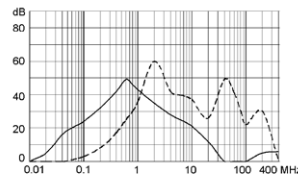

All Variants

Rated Current [A]	Filter-Type	L [mH]	Co / C2 (X2) [µF]	C1 (Y2) [nF]	Diagram	Weight [g]	Housings	Order Number
0.6	Standard Version	2 x 40	0.015	2.2	S1	27 g	13P	5500.2000
1	Standard Version	2 x 10	0.015	2.2	S1	27 g	13P	5500.2001
2	Standard Version	2 x 4	0.015	2.2	S1	27 g	13P	5500.2002
4	Standard Version	2 x 1.5	0.015	2.2	S1	27 g	13P	5500.2003
6	Standard Version	2 x 0.8	0.015	2.2	S1	35 g	13P	5500.2004
0.7	Standard Version	2 x 40	0.015	2.2	S1	32 g	18P	5500.2005
1	Standard Version	2 x 20	0.022	2.2	S1	32 g	18P	5500.2006
2	Standard Version	2 x 6	0.022	2.2	S1	32 g	18P	5500.2007
3	Standard Version	2 x 3	0.022	2.2	S1	32 g	18P	5500.2008
1	Standard Version	2 x 30	0.047	2.2	S1	78 g	24P	5500.2009
3	Standard Version	2 x 4	0.047	2.2	S1	78 g	24P	5500.2010
0.6	Medical Version (M5)	2 x 40	0.015	-	S2	35 g	13P	5500.2116
1	Medical Version (M5)	2 x 10	0.015	-	S2	35 g	13P	5500.2117
2	Medical Version (M5)	2 x 4	0.015	-	S2	25.5 g	13P	5500.2118
4	Medical Version (M5)	2 x 1.5	0.015	-	S2	35 g	13P	5500.2119
6	Medical Version (M5)	2 x 0.8	0.015	-	S2	35 g	13P	5500.2120
0.7	Medical Version (M5)	2 x 40	0.015	-	S2	45 g	18P	5500.2121
1	Medical Version (M5)	2 x 20	0.022	-	S2	45 g	18P	5500.2122
2	Medical Version (M5)	2 x 6	0.022	-	S2	45 g	18P	5500.2123
3	Medical Version (M5)	2 x 3	0.022	-	S2	45 g	18P	5500.2124
1	Medical Version (M5)	2 x 30	0.047	-	S2	78 g	24P	5500.2125
3	Medical Version (M5)	2 x 4	0.047	-	S2	78 g	24P	5500.2126

Most Popular.

Availability for all products can be searched real-time:<http://www.schurter.com/en/Stock-Check/Stock-Check-SCHURTER>

Packaging unit 50 Pcs