

## Switch Mode Power Supply

# S8VK-G (15/30/60/120/240/480-W Models)

**Reliable and Easy Operation-Worldwide Power Supply**  
**Resistant in tough environments**  
**Easy and fast installation**  
**The most compact class on the market**

- Universal input for worldwide applications:  
100 to 240 VAC (85 to 264 VAC)
- DC input can be available: 90 to 350 VDC
- Possible for 2-phase input usage.
- Wide operation temperature range: -40 to 70 °C
- Power Boost function at 120%
- Conformal coated models available: coating protects internal parts against contaminants in the ambient air
- Safety standards:  
UL508/60950-1, CSA C22.2 No. 107.1/60950-1  
EN50178, EN60950-1.  
Lloyd's standards, EN60204-1 PELV  
Safety of Power Transformers: EN61558-2-16
- ANSI/ISA 12.12.01 (excluding 480-W models)
- UL Class I Div 2 approved
- CSA C22.2 No.213 (excluding 480-W models)
- 15-W,30-W, and 60-W models conform to UL Class 2 output Standards
- EMS: EN 61204-3  
EMI: EN 61204-3 Class B
- Five-year warranty \*1

\*1 See the Terms of Warranty on page 22.



 Refer to *Safety Precautions for All Power Supplies* and *Safety Precautions* on page 17.

# S8VK-G

## Model Number Structure

### Model Number Legend

**Note:** Not all combinations are possible. Refer to *List of Models* in *Ordering Information*, below.

S8VK- 

|  |  |  |  |  |  |
|--|--|--|--|--|--|
|  |  |  |  |  |  |
|--|--|--|--|--|--|

 - 

|  |
|--|
|  |
|--|

1    2    3    4

#### 1. Input voltage type

G: Single phase

#### 2. Power Ratings

015: 15 W  
030: 30 W  
060: 60 W  
120: 120 W  
240: 240 W  
480: 480 W

#### 3. Output voltage

05: 5 V  
12: 12 V  
24: 24 V  
48: 48 V

#### 4. Option

None: Standard model  
400: Coating

## Ordering Information

**Note:** For details on normal stock models, contact your nearest OMRON representative.

### Standard Models

| Power ratings | Input voltage                                   | Output Voltage | Output current | Boost Current | Model number |
|---------------|---|----------------|----------------|---------------|--------------|
| 15 W          | Single phase<br>100 to 240 VAC<br>90 to 350 VDC | 5 V            | 3 A            | 3.6 A         | S8VK-G01505  |
|               |   | 12 V           | 1.2 A          | 1.44 A        | S8VK-G01512  |
|               |   | 24 V           | 0.65 A         | 0.78 A        | S8VK-G01524  |
| 30 W          |   | 5 V            | 5 A            | 6 A           | S8VK-G03005  |
|               |   | 12 V           | 2.5 A          | 3 A           | S8VK-G03012  |
|               |   | 24 V           | 1.3 A          | 1.56 A        | S8VK-G03024  |
| 60 W          |   | 12 V           | 4.5 A          | 5.4 A         | S8VK-G06012  |
|               |   | 24 V           | 2.5 A          | 3 A           | S8VK-G06024  |
| 120 W         |   | 24 V           | 5 A            | 6 A           | S8VK-G12024  |
| 240 W         |   | 24 V           | 10 A           | 12 A          | S8VK-G24024  |
|               |   | 48 V           | 5 A            | 6 A           | S8VK-G24048  |
| 480 W         |   | 24 V           | 20 A           | 24 A          | S8VK-G48024  |
|               | 48 V  | 10 A           | 12 A           | S8VK-G48048   |              |

### Conformal Coated Models

| Power ratings | Input voltage                                   | Output Voltage | Output current | Boost Current  | Model number   |
|---------------|---|----------------|----------------|----------------|----------------|
| 15 W          | Single phase<br>100 to 240 VAC<br>90 to 350 VDC | 5 V            | 3 A            | 3.6 A          | S8VK-G01505400 |
|               |   | 12 V           | 1.2 A          | 1.44 A         | S8VK-G01512400 |
|               |   | 24 V           | 0.65 A         | 0.78 A         | S8VK-G01524400 |
| 30 W          |   | 5 V            | 5 A            | 6 A            | S8VK-G03005400 |
|               |   | 12 V           | 2.5 A          | 3 A            | S8VK-G03012400 |
|               |   | 24 V           | 1.3 A          | 1.56 A         | S8VK-G03024400 |
| 60 W          |   | 12 V           | 4.5 A          | 5.4 A          | S8VK-G06012400 |
|               |   | 24 V           | 2.5 A          | 3 A            | S8VK-G06024400 |
| 120 W         |   | 24 V           | 5 A            | 6 A            | S8VK-G12024400 |
| 240 W         |   | 24 V           | 10 A           | 12 A           | S8VK-G24024400 |
|               |   | 48 V           | 5 A            | 6 A            | S8VK-G24048400 |
| 480 W         |   | 24 V           | 20 A           | 24 A           | S8VK-G48024400 |
|               | 48 V  | 10 A           | 12 A           | S8VK-G48048400 |                |

# Specifications

## Ratings, Characteristics, and Functions

| Item   | Power rating<br>Output voltage    | 15 W   |  |  | 30 W   |                                      |                                      |                                      |
|--|-----------------------------------|--|--|--|--|--------------------------------------|--------------------------------------|--------------------------------------|
|  |                                   | 5 V  | 12 V   | 24 V   | 5 V  | 12 V                                 | 24 V                                 |                                      |
| Efficiency                                   | 230 VAC input *6                  | 77% typ.   | 77% typ.   | 80% typ.   | 79% typ.   | 82% typ.                             | 86% typ.                             |                                      |
| Input  | Voltage range *1                  | Single-phase, 85 to 264 VAC, 90 to 350 VDC *10   |  |  |  |                                      |                                      |                                      |
|  | Frequency *1                      | 50/60 Hz (47 to 450 Hz)  |  |  |  |                                      |                                      |                                      |
|  | Current                           | 115 VAC input *6   | 0.32 A typ.                                      | 0.3 A typ.                                       | 0.31 A typ.  | 0.5 A typ.                           | 0.57 A typ.                          | 0.58 A typ.                          |
|  |                                   | 230 VAC input *6   | 0.2 A typ.                                       | 0.21 A typ.                                      | 0.2 A typ.   | 0.32 A typ.                          | 0.37 A typ.                          | 0.36 A typ.                          |
|  | Power factor                      | 230 VAC input, 100% load   |  | 0.42 min.  | 0.43 min.  |                                      | 0.42 min.                            | 0.43 min.                            |
|  | Leakage current                   | 115 VAC input  | 0.14 mA typ.                                     |  |  | 0.13 mA typ.                         |                                      |                                      |
|  |                                   | 230 VAC input  | 0.25 mA typ.                                     |  |  | 0.24 mA typ.                         |                                      |                                      |
| Inrush current *2 (for a cold start at 25°C) | 115 VAC input                     | 16 A typ.  |  |  | 16 A typ.  |                                      |                                      |                                      |
|  | 230 VAC input                     | 32 A typ.  |  |  | 32 A typ.  |                                      |                                      |                                      |
| Output                                       | Rated output current              | 3 A  | 1.2 A  | 0.65 A   | 5 A  | 2.5 A                                | 1.3 A                                |                                      |
|  | Boost current                     | 3.6 A  |  | 1.44 A   | 0.78 A   | 6 A                                  | 3 A                                  | 1.56 A                               |
|  | Voltage adjustment range *3       | -10% to 15% (with V.ADJ) (guaranteed)  |  |  |  |                                      |                                      |                                      |
|  | Ripple & Noise voltage *4         | 100 to 240 VAC input, 100% load *6   | 60 mVp-p max. at 20 MHz of bandwidth             | 50 mVp-p max. at 20 MHz of bandwidth             | 30 mVp-p max. at 20 MHz of bandwidth   | 30 mVp-p max. at 20 MHz of bandwidth | 30 mVp-p max. at 20 MHz of bandwidth | 30 mVp-p max. at 20 MHz of bandwidth |
|  | Input variation influence *8      | 0.4% max.  |  |  | 0.4% max.  |                                      |                                      |                                      |
|  | Load variation influence *7       | 0.8% max.  |  |  | 0.8% max.  |                                      |                                      |                                      |
|  | Temperature variation influence   | 115 to 230 VAC input   | 0.05%/°C max.                                    |  |  | 0.05%/°C max.                        |                                      |                                      |
|  | Start up time *2                  | 115 VAC input *6   | 530 ms typ.                                      | 520 ms typ.                                      | 580 ms typ.  | 550 ms typ.                          | 550 ms typ.                          | 600 ms typ.                          |
|  |                                   | 230 VAC input *6   | 330 ms typ.                                      | 400 ms typ.                                      | 400 ms typ.  | 430 ms typ.                          | 490 ms typ.                          | 480 ms typ.                          |
|  | Hold time *2                      | 115 VAC input *6   | 28 ms typ.                                       | 29 ms typ.                                       | 32 ms typ.   | 33 ms typ.                           | 36 ms typ.                           | 23 ms typ.                           |
|  |                                   | 230 VAC input *6   | 134 ms typ.                                      | 138 ms typ.                                      | 134 ms typ.  | 177 ms typ.                          | 170 ms typ.                          | 154 ms typ.                          |
| Additional functions                         | Overload protection               | Yes, automatic reset   |  |  | Yes, automatic reset   |                                      |                                      |                                      |
|  | Overvoltage protection *5         | Yes, 130% or higher of rated output voltage, power shut off (shut off the input voltage and turn on the input again)   |  |  |  |                                      |                                      |                                      |
|  | Series operation                  | Yes (For up to two Power Supplies, external diodes are required.)  |  |  |  |                                      |                                      |                                      |
|  | Parallel operation                | Yes (Refer to <i>Safety Precautions</i> ) (For up to two Power Supplies)   |  |  |  |                                      |                                      |                                      |
|  | Output indicator                  | Yes (LED: Green), lighting from 80% to 90% or more of rated voltage  |  |  |  |                                      |                                      |                                      |
| Insulation                                   | Withstand voltage                 | 3.0 kVAC for 1 min. (between all input terminals and output terminals), current cutoff 20 mA   |  |  | 2.0 kVAC for 1 min. (between all input terminals and PE terminals), current cutoff 20 mA |                                      |                                      |                                      |
|  |                                   | 1.0 kVAC for 1 min. (between all output terminals and PE terminals), current cutoff 20 mA  |  |  |  |                                      |                                      |                                      |
|  |                                   | 100 MΩ min. (between all output terminals and all input terminals/PE terminals) at 500 VDC   |  |  |  |                                      |                                      |                                      |
| Environment                                  | Ambient operating temperature *12 | -40 to 70°C (Derating is required according to the temperature. Refer to <i>Engineering Data</i> ) (with no condensation or icing)   |  |  |  |                                      |                                      |                                      |
|  | Storage temperature               | -40 to 85°C (with no condensation or icing)  |  |  |  |                                      |                                      |                                      |
|  | Ambient operating humidity        | 0% to 95% (Storage humidity: 0% to 95%)  |  |  |  |                                      |                                      |                                      |
|  | Vibration resistance              | 10 to 55 Hz, 0.375 mm half amplitude for 2 h each in X, Y, and Z directions  |  |  |  |                                      |                                      |                                      |
|  | Shock resistance                  | 150 m/s <sup>2</sup> , 3 times each in ±X, ±Y, and ±Z directions   |  |  |  |                                      |                                      |                                      |
| Reliability                                  | MTBF                              | 135,000 hrs min.   |  |  |  |                                      |                                      |                                      |
|  | Life expectancy *9                | 10 years min.  |  |  |  |                                      |                                      |                                      |
| Construction                                 | Weight                            | 150 g max.   |  |  |  | 195 g max.                           |                                      |                                      |
|  | Cooling fan                       | No   |  |  |  |                                      |                                      |                                      |
| Standards                                    | Degree of protection              | IP20 by EN/IEC 60529   |  |  |  |                                      |                                      |                                      |
|  | Harmonic current emissions        | Conforms to EN 61000-3-2   |  |  |  |                                      |                                      |                                      |
|  |                                   | EMI  | Conducted Emissions                              | Conforms to EN 61204-3 Class B, EN 55011 Class B |  |                                      |                                      |                                      |
|  | Radiated Emissions                |  | Conforms to EN 61204-3 Class B, EN 55011 Class B |  |  |                                      |                                      |                                      |
|  | EMS                               | Conforms to EN 61204-3 high severity levels  |  |  |  |                                      |                                      |                                      |
|  | Approved Standards                | UL Listed: UL 508 (Listing, Class2 Output: Per UL 1310)<br>UL UR: UL 60950-1 (Recognition)<br>cUL: CSA C22.2 No. 107.1 (Class2 Output: Per CSA C22.2 No.223)<br>cUR: CSA C22.2 No.60950-1<br>EN/VDE: EN 50178, EN 60950-1<br>ANSI/ISA 12.12.01 |  |  |  |                                      |                                      |                                      |
|  |                                   | Conformed Standards  | PELV (EN 60204-1, EN 50178)                      |  |  |                                      |                                      |                                      |
|  |                                   |  | EN 61558-2-16                                    |  |  |                                      |                                      |                                      |
|  |                                   | Marine Standards   | Lloyd's register *10 *11                         |  |  |                                      |                                      |                                      |
|  | SEMI                              | Conforms to F47-0706 ( 200 to 240 VAC input)   |  |  |  |                                      |                                      |                                      |

\*1. Do not use an inverter output for the Power Supply. Inverters with an output frequency of 50/60 Hz are available, but the rise in the internal temperature of the Power Supply may result in ignition or burning.

\*2. For a cold start at 25°C. Refer to *Engineering Data* on page 9 to 11 for details.

\*3. If the output voltage adjuster (V. ADJ) is turned, the voltage will increase by more than +15% of the voltage adjustment range. When adjusting the output voltage, confirm the actual output voltage from the Power Supply and be sure that the load is not damaged.

\*4. A characteristic when the ambient operating temperature is between -25 to 70°C.

\*5. Refer to *Overvoltage Protection* on page 10 for the time when input voltage shuts off and input turns on again.

\*6. The value is when both rated output voltage and rated output current are satisfied.

\*7. 100 to 240 VAC input, in the range of 0 A to the rated output current

\*8. This is the maximum variation in the output voltage when the input voltage is gradually changed within the allowable input voltage range at the rated output voltage and rated output current.

\*9. Refer to *Recommended Replacement Periods and Periodic Replacement for Preventive Maintenance* on page 22 for details.

\*10. Safety Standards for a DC Input

The following safety standards apply to a DC input: UL 60950-1, cUR (CSA C22.2 No. 60950-1), EN 50178, EN 60950-1, and Lloyd's.

For a DC input, safety is ensured by an external fuse.

Select an external fuse that meets the following conditions.

S8VK-G015□□: 350 VDC min, 3 A

S8VK-G030□□: 350 VDC min, 4 A

\*11. Clamp filter "ZCAT2035-0930" manufactured by TDK Corporation. or equivalent should be installed in the cable connected to the input - output terminals of S8VK-G series.

Noise filter "FN2080-10-06" manufactured by SCHAFFNER Corporation. or equivalent should be connected to the Input terminals of S8VK-G series.

\*12. At -40 to -25°C, time will be required before the rated output voltage is output after the input voltage is input.

Also, the ripple noise value may exceed the value shown in the above table.

# S8VK-G

| Item   | Power rating                      |   | 60 W   |             | 120 W                                 |
|--|-----------------------------------|---|--|-------------|---------------------------------------|
|  | Output voltage                    |   | 12 V   | 24 V        | 24 V                                  |
| Efficiency                                   | 230 VAC input *6                  |   | 85% typ.   | 88% typ.    | 89% typ.                              |
| Input  | Voltage range *1                  |   | Single-phase, 85 to 264 VAC, 90 to 350 VDC *10   |             |                                       |
|  | Frequency *1                      |   | 50/60 Hz (47 to 450 Hz)  |             | 50/60 Hz (47 to 63 Hz)                |
|  | Current                           | 115 VAC input *6  | 1.0 A typ.   | 1.1 A typ.  | 1.3 A typ.                            |
|  |                                   | 230 VAC input *6  | 0.6 A typ.   | 0.7 A typ.  | 0.7 A typ.                            |
|  | Power factor                      | 230 VAC input, 100% load  | 0.46 min.  | 0.45 min.   | 0.94 min.                             |
|  | Leakage current                   | 115 VAC input   | 0.16 mA typ.   |             | 0.24 mA typ.                          |
|  |                                   | 230 VAC input   | 0.30 mA typ.   |             | 0.38 mA typ.                          |
| Inrush current *2 (for a cold start at 25°C) | 115 VAC input                     | 16 A typ.   |  | 16 A typ.   |                                       |
|  | 230 VAC input                     | 32 A typ.   |  | 32 A typ.   |                                       |
| Output                                       | Rated output current              |   | 4.5 A  | 2.5 A       | 5 A                                   |
|  | Boost current                     |   | 5.4 A  | 3 A         | 6 A                                   |
|  | Voltage adjustment range *3       |   | -10% to 15% (with V. ADJ) (guaranteed)   |             |                                       |
|  | Ripple & Noise                    | 100 to 240 VAC input, 100% load *6  | 150 mVp-p max. at 20 MHz of bandwidth  |             | 150 mVp-p max. at 20 MHz of bandwidth |
|  |                                   |   | 50 mVp-p max. at 20 MHz of bandwidth   |             | 150 mVp-p max. at 20 MHz of bandwidth |
|  | Input variation influence *8      |   | 0.4% max.  |             | 0.4% max.                             |
|  | Load variation influence *7       |   | 0.8% max.  |             | 0.8% max.                             |
|  | Temperature variation influence   | 115 to 230 VAC input  | 0.05%/°C max.  |             | 0.05%/°C max.                         |
|  |                                   |   | 0.05%/°C max.  |             | 0.05%/°C max.                         |
|  | Start up time *2                  | 115 VAC input *6  | 570 ms typ.  | 650 ms typ. | 790 ms typ.                           |
| 230 VAC input *6                             |                                   | 430 ms typ.   | 500 ms typ.  | 750 ms typ. |                                       |
| Hold time *2                                 | 115 VAC input *6                  | 26 ms typ.  | 25 ms typ.   | 42 ms typ.  |                                       |
|  | 230 VAC input *6                  | 139 ms typ.   | 129 ms typ.  | 42 ms typ.  |                                       |
| Additional functions                         | Overload protection               |   | Yes, automatic reset   |             | Yes, automatic reset                  |
|  | Overvoltage protection *5         |   | Yes, 130% or higher of rated output voltage, power shut off (shut off the input voltage and turn on the input again)               |             |                                       |
|  | Series operation                  |   | Yes (For up to two Power Supplies, external diodes are required.)  |             |                                       |
|  | Parallel operation                |   | Yes (Refer to <i>Safety Precautions</i> ) (For up to two Power Supplies)   |             |                                       |
|  | Output indicator                  |   | Yes (LED: Green), lighting from 80% to 90% or more of rated voltage  |             |                                       |
| Insulation                                   | Withstand voltage                 |   | 3.0 kVAC for 1 min. (between all input terminals and output terminals), current cutoff 20 mA                                       |             |                                       |
|  |                                   |   | 2.0 kVAC for 1 min. (between all input terminals and PE terminals), current cutoff 20 mA   |             |                                       |
|  |                                   |   | 1.0 kVAC for 1 min. (between all output terminals and PE terminals), current cutoff 20 mA  |             |                                       |
| Insulation resistance                        |                                   | 100 MΩ min. (between all output terminals and all input terminals/PE terminals) at 500 VDC  |  |             |                                       |
| Environment                                  | Ambient operating temperature *12 |   | -40 to 70°C (Derating is required according to the temperature. Refer to <i>Engineering Data</i> ) (with no condensation or icing) |             |                                       |
|  | Storage temperature               |   | -40 to 85°C (with no condensation or icing)  |             |                                       |
|  | Ambient operating humidity        |   | 0% to 95% (Storage humidity: 0% to 95%)  |             |                                       |
|  | Vibration resistance              |   | 10 to 55 Hz, 0.375 mm half amplitude for 2 h each in X, Y, and Z directions  |             |                                       |
|  | Shock resistance                  |   | 150 m/s <sup>2</sup> , 3 times each in ±X, ±Y, ±Z directions   |             |                                       |
| Reliability                                  | MTBF                              |   | 135,000 hrs min.   |             |                                       |
|  | Life expectancy *9                |   | 10 years min.  |             |                                       |
| Construction                                 | Weight                            |   | 260 g max.   |             | 620 g max.                            |
|  | Cooling fan                       |   | No   |             |                                       |
|  | Degree of protection              |   | IP20 by EN/IEC 60529   |             |                                       |
| Standards                                    | Harmonic current emissions        |   | Conforms to EN 61000-3-2   |             |                                       |
|  | EMI                               | Conducted Emissions   | Conforms to EN 61204-3 Class B, EN 55011 Class B   |             |                                       |
|  |                                   | Radiated Emissions  | Conforms to EN 61204-3 Class B, EN 55011 Class B   |             |                                       |
|  | EMS                               |   | Conforms to EN 61204-3 high severity levels  |             |                                       |
|  | Approved Standards                | UL Listed: UL 508 (Listing, For 60 W only Class2 Output: Per UL 1310 )  |  |             |                                       |
|  |                                   | UL UR: UL 60950-1 (Recognition)   |  |             |                                       |
|  |                                   | cUL: CSA C22.2 No.107.1 (For 60 W only Class2 Output: Per CSA C22.2 No.223)<br>cUR: CSA C22.2 No.60950-1<br>EN/VDE: EN 50178, EN 60950-1<br>ANSI/ISA 12.12.01 |  |             |                                       |
|  | Conformed Standards               |   | PELV (EN 60204-1, EN 50178)<br>EN 61558-2-16   |             |                                       |
| Marine Standards                             |                                   | Lloyd's register *10 *11  |  |             |                                       |
| SEMI   |                                   | Conforms to F47-0706 (200 to 240 VAC input)   |  |             |                                       |

- \*1. Do not use an inverter output for the Power Supply. Inverters with an output frequency of 50/60 Hz are available, but the rise in the internal temperature of the Power Supply may result in ignition or burning.
- \*2. For a cold start at 25°C. Refer to *Engineering Data* on page 9 to 11 for details.
- \*3. If the output voltage adjuster (V. ADJ) is turned, the voltage will increase by more than +15% of the voltage adjustment range. When adjusting the output voltage, confirm the actual output voltage from the Power Supply and be sure that the load is not damaged.
- \*4. A characteristic when the ambient operating temperature is between -25 to 70°C.
- \*5. Refer to *Overvoltage Protection* on page 10 for the time when input voltage shuts off and input turns on again.
- \*6. The value is when both rated output voltage and rated output current are satisfied.
- \*7. 100 to 240 VAC input, in the range of 0 A to the rated output current
- \*8. This is the maximum variation in the output voltage when the input voltage is gradually changed within the allowable input voltage range at the rated output voltage and rated output current.
- \*9. Refer to *Recommended Replacement Periods and Periodic Replacement for Preventive Maintenance* on page 22 for details.
- \*10. Safety Standards for a DC Input  
The following safety standards apply to a DC input: UL 60950-1, cUR (CSA C22.2 No. 60950-1), EN 50178, EN 60950-1, and Lloyd's.
- For a DC input, safety is ensured by an external fuse.  
Select an external fuse that meets the following conditions.  
S8VK-G060□□: 350 VDC min, 6 A  
S8VK-G12024: 350 VDC min, 5 A
- \*11. Clamp filter "ZCAT2035-0930" manufactured by TDK Corporation. or equivalent should be installed in the cable connected to the input - output terminals of S8VK-G series.  
Noise filter "FN2080-10-06" manufactured by SCHAFFNER Corporation. or equivalent should be connected to the Input terminals of S8VK-G series.
- \*12. At -40 to -25°C, time will be required before the rated output voltage is output after the input voltage is input.  
Also, the ripple noise value may exceed the value shown in the above table.



| Item   | Power rating<br>Output voltage    | 240 W   |  | 480 W                                 |                                       |                                       |
|--|-----------------------------------|---|--|---------------------------------------|---------------------------------------|---------------------------------------|
|  |                                   | 24 V  | 48 V   | 24 V                                  | 48 V                                  |                                       |
| Efficiency                                   | 230 VAC input *6                  | 92% typ.  |  | 93% typ.                              |                                       |                                       |
| Input  | Voltage range *1                  | Single-phase, 85 to 264 VAC, 90 to 350 VDC *10  |  |                                       |                                       |                                       |
|  | Frequency *1                      | 50/60 Hz (47 to 63 Hz)  |  |                                       |                                       |                                       |
|  | Current                           | 115 VAC input *6  | 2.4 A typ.                                       |                                       | 4.7 A typ.                            |                                       |
|  |                                   | 230 VAC input *6  | 1.3 A typ.                                       |                                       | 2.3 A typ.                            |                                       |
|  | Power factor                      | 230 VAC input, 100% load  | 0.9 min.   |                                       | 0.97 min.                             |                                       |
|  | Leakage current                   | 115 VAC input   | 0.23 mA typ.                                     |                                       | 0.3 mA typ.                           |                                       |
|  |                                   | 230 VAC input   | 0.33 mA typ.                                     |                                       | 0.49 mA typ.                          |                                       |
| Inrush current *2 (for a cold start at 25°C) | 115 VAC input                     | 16 A typ.   |  | 16 A typ.                             |                                       |                                       |
|  | 230 VAC input                     | 32 A typ.   |  | 32 A typ.                             |                                       |                                       |
| Output                                       | Rated output current              | 10 A  | 5 A  | 20 A                                  | 10 A                                  |                                       |
|  | Boost current                     | 12 A  | 6 A  | 24 A                                  | 12 A                                  |                                       |
|  | Voltage adjustment range *3       | -10% to 15% (with V.ADJ) (guaranteed)   |  |                                       |                                       |                                       |
|  | Ripple & Noise                    | 100 to 240 VAC input, 100% load *6  | 180 mVp-p max. at 20 MHz of bandwidth            | 350 mVp-p max. at 20 MHz of bandwidth | 230 mVp-p max. at 20 MHz of bandwidth | 470 mVp-p max. at 20 MHz of bandwidth |
|  | Input variation influence *8      | 0.4% max.   |  |                                       |                                       |                                       |
|  | Load variation influence *7       | 0.8% max.   |  |                                       |                                       |                                       |
|  | Temperature variation influence   | 115 to 230 VAC input  | 0.05%/°C max.                                    |                                       |                                       |                                       |
|  | Start up time *2                  | 115 VAC input *6  | 250 ms typ.                                      | 290 ms typ.                           | 380 ms typ.                           |                                       |
|  |                                   | 230 VAC input *6  | 250 ms typ.                                      | 290 ms typ.                           | 260 ms typ.                           |                                       |
|  | Hold time *2                      | 115 VAC input *6  | 44 ms typ.                                       | 43 ms typ.                            | 40 ms typ.                            |                                       |
|  |                                   | 230 VAC input *6  | 44 ms typ.                                       |                                       | 50 ms typ.                            |                                       |
| Additional functions                         | Overload protection               | Yes, automatic reset  |  |                                       | Yes, automatic reset                  |                                       |
|  | Overvoltage protection *5         | Yes, 130% or higher of rated output voltage, power shut off (shut off the input voltage and turn on the input again)  |  |                                       |                                       |                                       |
|  | Series operation                  | Yes (For up to two Power Supplies, external diodes are required.)   |  |                                       |                                       |                                       |
|  | Parallel operation                | Yes (Refer to <i>Safety Precautions</i> ) (For up to two Power Supplies)  |  |                                       |                                       |                                       |
|  | Output indicator                  | Yes (LED: Green), lighting from 80% to 90% or more of rated voltage   |  |                                       |                                       |                                       |
| Insulation                                   | Withstand voltage                 | 3.0 kVAC for 1 min. (between all input terminals and output terminals), current cutoff 20 mA  |  |                                       |                                       |                                       |
|  |                                   | 2.0 kVAC for 1 min. (between all input terminals and PE terminals), current cutoff 20 mA  |  |                                       |                                       |                                       |
|  |                                   | 1.0 kVAC for 1 min. (between all output terminals and PE terminals), current cutoff 20 mA   |  |                                       |                                       |                                       |
|  | Insulation resistance             | 100 MΩ min. (between all output terminals and all input terminals/PE terminals) at 500 VDC  |  |                                       |                                       |                                       |
| Environment                                  | Ambient operating temperature *12 | -40 to 70 °C (Derating is required according to the temperature. Refer to <i>Engineering Data</i> ) (with no condensation or icing)   |  |                                       |                                       |                                       |
|  | Storage temperature               | -40 to 85°C (with no condensation or icing)   |  |                                       |                                       |                                       |
|  | Ambient operating humidity        | 0% to 95% (Storage humidity: 0% to 95%)   |  |                                       |                                       |                                       |
|  | Vibration resistance              | 10 to 55 Hz, 0.375 mm half amplitude for 2 h each in X, Y, and Z directions   |  |                                       |                                       |                                       |
|  | Shock resistance                  | 150 m/s <sup>2</sup> , 3 times each in ±X, ±Y, ±Z directions  |  |                                       |                                       |                                       |
| Reliability                                  | MTBF                              | 135,000 hrs min.  |  |                                       |                                       |                                       |
|  | Life expectancy *9                | 10 years min.   |  |                                       |                                       |                                       |
| Construction                                 | Weight                            | 900 g max.  |  | 1,500 g max.                          |                                       |                                       |
|  | Cooling fan                       | No  |  |                                       |                                       |                                       |
|  | Degree of protection              | IP20 by EN/IEC 60529  |  |                                       |                                       |                                       |
| Standards                                    | Harmonic current emissions        |   | Conforms to EN 61000-3-2                         |                                       |                                       |                                       |
|  | EMI                               | Conducted Emissions   | Conforms to EN 61204-3 Class B, EN 55011 Class B |                                       |                                       |                                       |
|  |                                   | Radiated Emissions  | Conforms to EN 61204-3 Class B, EN 55011 Class B |                                       |                                       |                                       |
|  | EMS                               |   | Conforms to EN 61204-3 high severity levels      |                                       |                                       |                                       |
|  | Approved Standards                | UL Listed: UL 508 (Listing)<br>UL UR: UL 60950-1 (Recognition)<br>cUL: CSA C22.2 No.107.1<br>cUR: CSA C22.2 No.60950-1<br>EN/VDE: EN 50178, EN 60950-1<br>ANSI/ISA 12.12.01 |  |                                       |                                       |                                       |
|  |                                   | Conformed Standards   | PELV (EN 60204-1, EN 50178)                      |                                       |                                       |                                       |
|  |                                   |   | EN 61558-2-16                                    |                                       |                                       |                                       |
|  | Marine Standards                  |   | Lloyd's register *10 *11                         |                                       |                                       |                                       |
|  | SEMI                              |   | Conforms to F47-0706 (200 to 240 VAC input)      |                                       |                                       |                                       |

- \*1. Do not use an inverter output for the Power Supply. Inverters with an output frequency of 50/60 Hz are available, but the rise in the internal temperature of the Power Supply may result in ignition or burning.
- \*2. For a cold start at 25°C. Refer to *Engineering Data* on page 9 to 11 for details.
- \*3. If the output voltage adjuster (V. ADJ) is turned, the voltage will increase by more than +15% of the voltage adjustment range. When adjusting the output voltage, confirm the actual output voltage from the Power Supply and be sure that the load is not damaged.
- \*4. A characteristic when the ambient operating temperature is between -25 to 70°C.
- \*5. Refer to *Overvoltage Protection* on page 10 for the time when input voltage shuts off and input turns on again.
- \*6. The value is when both rated output voltage and rated output current are satisfied.
- \*7. 100 to 240 VAC input, in the range of 0 A to the rated output current
- \*8. This is the maximum variation in the output voltage when the input voltage is gradually changed within the allowable input voltage range at the rated output voltage and rated output current.
- \*9. Refer to *Recommended Replacement Periods and Periodic Replacement for Preventive Maintenance* on page 22 for details.
- \*10. Safety Standards for a DC Input  
The following safety standards apply to a DC input: UL 60950-1, cUR (CSA C22.2 No. 60950-1), EN 50178, EN 60950-1, and Lloyd's.  
For a DC input, safety is ensured by an external fuse.  
Select an external fuse that meets the following conditions.  
S8VK-G240□□: 350 VDC min, 8 A  
S8VK-G480□□: 350 VDC min, 12 A
- \*11. Clamp filter "ZCAT2035-0930" manufactured by TDK Corporation. or equivalent should be installed in the cable connected to the input - output terminals of S8VK-G series.  
Noise filter "FN2080-10-06" manufactured by SCHAFFNER Corporation. or equivalent should be connected to the input terminals of S8VK-G series.
- \*12. At -40 to -25°C, time will be required before the rated output voltage is output after the input voltage is input.  
Also, the ripple noise value may exceed the value shown in the above table.

# S8VK-G

## Connections

### Block Diagrams

S8VK-G015□□ (15 W)

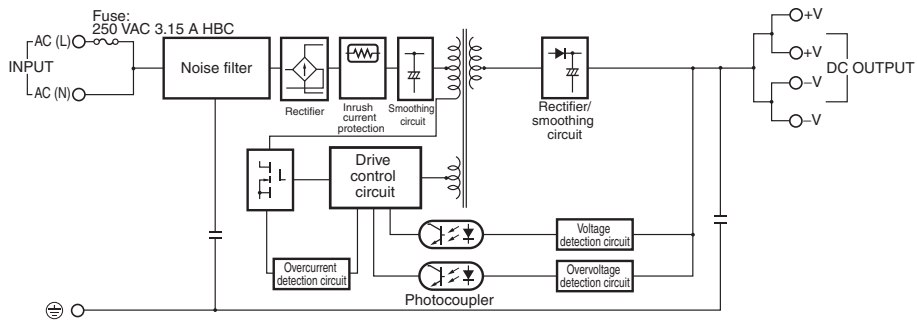

S8VK-G030□□ (30 W)

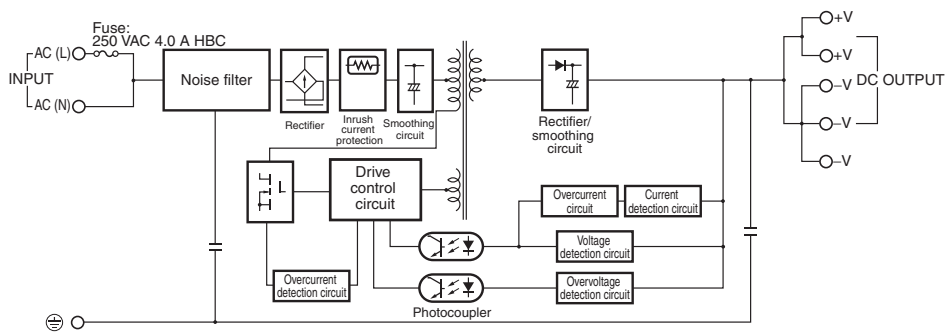

S8VK-G060□□ (60 W)

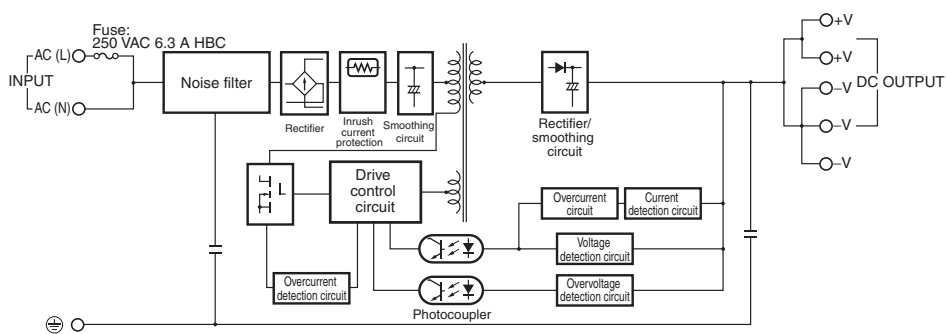



# S8VK-G

## Construction and Nomenclature

### Nomenclature

#### 15-W Models

S8VK-G015□□

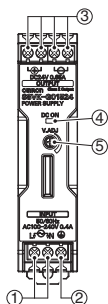

#### 30-W Models

S8VK-G030□□

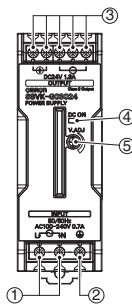

#### 60-W Models

S8VK-G060□□

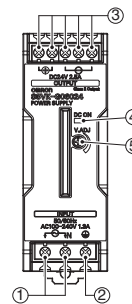

#### 120-W Models

S8VK-G12024

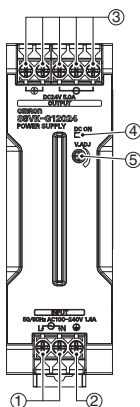

#### 240-W Models

S8VK-G240□□

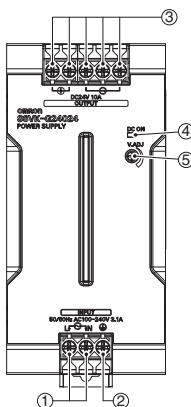

#### 480-W Models

S8VK-G480□□

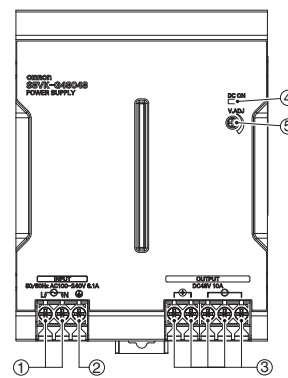

| No. | Name                            | Function   |
|-----|---------------------------------|--|
| 1   | Input terminals (L), (N)        | Connect the input lines to these terminals. *1   |
| 2   | Protective Earth terminal (PE)  | Connect the ground line to this terminal. *2     |
| 3   | DC Output terminals (-V), (+V)  | Connect the load lines to these terminals.       |
| 4   | Output indicator (DC ON: Green) | Lights while a direct current (DC) output is ON. |
| 5   | Output voltage adjuster (V.ADJ) | Use to adjust the voltage.                       |

\*1. The fuse is located on the (L) side. It is not user-replaceable. For a DC input, connect the positive voltage to the L terminal.  
 \*2. This is the protective earth terminal specified in the safety standards. Always ground this terminal.

## Engineering Data

### Derating Curve

15, 30, 240 W (S8VK-G015@@, S8VK-G030@@, S8VK-G240@@)

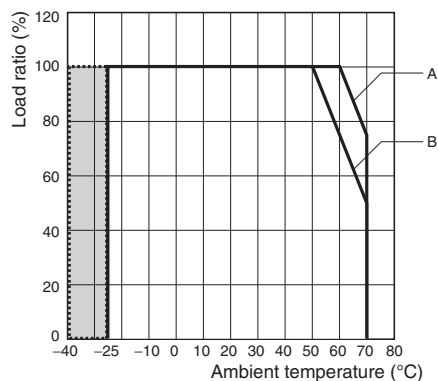

- Note:**
- At less than 90 VAC, the derating is 2.5%/V
  - For a DC power input, reduce the load given in the above derating curve by multiplying the following coefficients.  
 S8VK-G015□□: 1.0  
 S8VK-G030□□: 0.9  
 S8VK-G240□□: 0.8
  - This is the guaranteed value for startup.

- A.** Standard mounting  
**B.** Face-up mounting / Side mounting (15W only)

60 W (S8VK-G060@@)

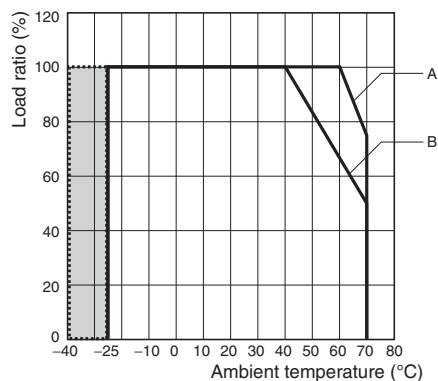

- Note:**
- At less than 90 VAC, the derating is 2.5%/V
  - For a DC power input, reduce the load given in the above derating curve by multiplying the following coefficients.  
 S8VK-G060□□: 0.9
  - This is the guaranteed value for startup.

- A.** Standard mounting  
**B.** Face-up mounting

120 W (S8VK-G12024)

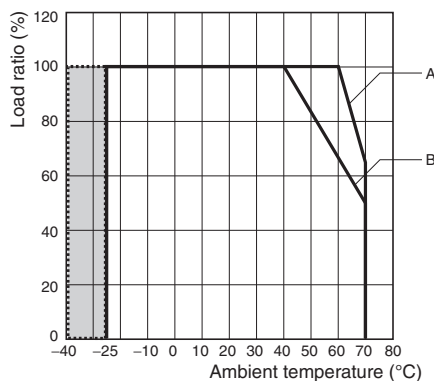

- Note:**
- At less than 90 VAC, the derating is 2.5%/V
  - For a DC power input, reduce the load given in the above derating curve by multiplying the following coefficients.  
 S8VK-G12024: 0.9
  - This is the guaranteed value for startup.

- A.** Standard mounting  
**B.** Face-up mounting

480 W (S8VK-G480@@)

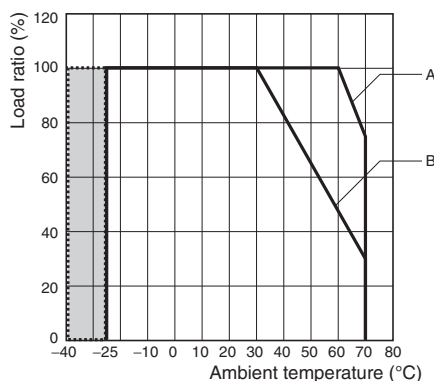

- Note:**
- At less than 90 VAC, the derating is 2.5%/V
  - For a DC power input, reduce the load given in the above derating curve by multiplying the following coefficients.  
 S8VK-G480□□: 0.8
  - This is the guaranteed value for startup.

- A.** Standard mounting  
**B.** Face-up mounting

## Mounting

- (A) Standard (Vertical) mounting
- (B) Face-up mounting

(C) Side mounting only for 15 W

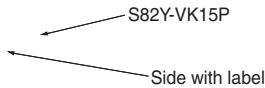

Side mounting is only for S8VK-G015□□. Use a mounting bracket (S82Y-VK15P, sold separately) when the product is mounted horizontally. Heat dissipation will be adversely affected. When the product is mounted facing horizontally, always place the side with label facing upward.

## Overload Protection

The load and the power supply are automatically protected from overcurrent damage by this function. Overload protection is activated if the output current rises above 121% of the rated current. When the output current returns within the rated range, overload protection is automatically cleared.

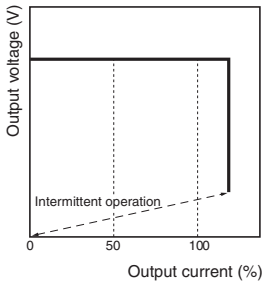

The values shown in the above diagrams are for reference only.

- Note: 1.** Internal parts may occasionally deteriorate or be damaged if a short-circuited or overcurrent state continues during operation.
- 2.** Internal parts may possibly deteriorate or be damaged if the Power Supply is used for applications with frequent inrush current or overloading at the load end. Do not use the Power Supply for such applications.

## Overvoltage Protection

Consider the possibility of an overvoltage and design the system so that the load will not be subjected to an excessive voltage even if the feedback circuit in the Power Supply fails. If an excessive voltage that is approximately 130% of the rated voltage or more is output, the output voltage is shut OFF. Reset the input power by turning it OFF for at least three minutes and then turning it back ON again.

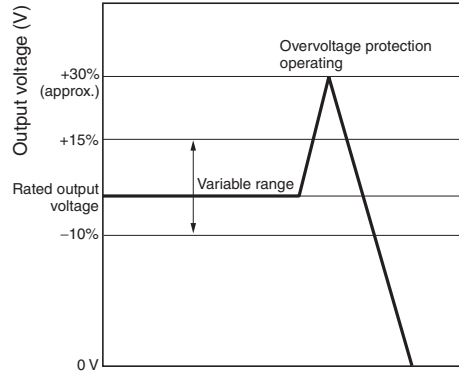

The values shown in the above diagram is for reference only.

**Note:** Do not turn ON the power again until the cause of the overvoltage has been removed.

## Inrush Current, Startup Time, Output Hold Time

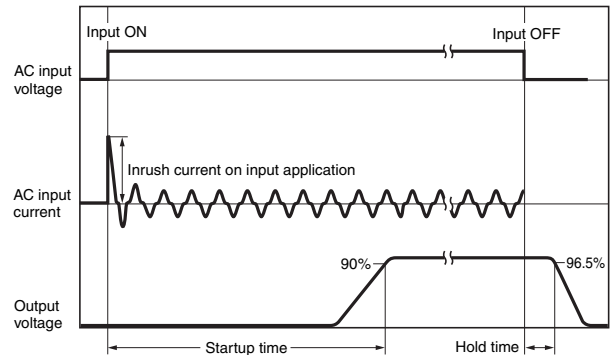

**Note:** Twice the input current or above will flow during the parallel operation or redundant system. Therefore, check the fusing characteristics of fuses and operating characteristics of breakers making sure that the external fuses will not burn out and the circuit breakers will not be activated by the inrush current.



## Two phases application for Single phase models

### For All Single phase Models, S8VK-G

Basically OMRON single phase power supply can be used on two-phases of a 3-phase-system when some of conditions satisfy like below.

1. The supplying voltage is below the maximum rated input.  
OMRON Power supply allows the input voltage equivalent or less than 240 VAC+10%.  
Please confirm the input voltage between two lines if the input voltage satisfies this condition before connecting.
2. The external protector is needed on N input line to secure a safety.  
N line has no protection of a fuse internally.  
An appropriate fuse or circuit breaker should be connected on N input line like the following.

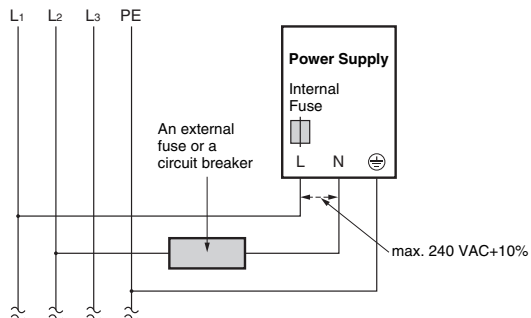

## Reference Value

|                           | Value  |
|---------------------------|--|
| <b>Reliability (MTBF)</b> | Single phase model<br>15 W: 600,000 hrs<br>30 W: 580,000 hrs<br>60 W: 590,000 hrs<br>120 W: 450,000 hrs<br>240 W: 360,000 hrs<br>480 W: 230,000 hrs  |
| <b>Definition</b>         | MTBF stands for Mean Time Between Failures, which is calculated according to the probability of accidental device failures, and indicates reliability of devices.<br>Therefore, it does not necessarily represent a life of the product. |
| <b>Life expectancy</b>    | 10 yrs. Min.   |
| <b>Definition</b>         | The life expectancy indicates average operating hours under the ambient temperature of 40°C and a load rate of 50%.<br>Normally this is determined by the life expectancy of the built-in aluminum electrolytic capacitor.               |

















## Safety Precautions

### Warning Indications

|  |   |
|--|---|
|  <b>CAUTION</b> | Indicates a potentially hazardous situation which, if not avoided, may result in minor or moderate injury or in property damage.              |
| <b>Precautions for Safe Use</b>  | Supplementary comments on what to do or avoid doing, to use the product safely.   |
| <b>Precautions for Correct Use</b>   | Supplementary comments on what to do or avoid doing, to prevent failure to operate, malfunction or undesirable effect on product performance. |

### Meaning of Product Safety Symbols

|  |  |
|--|--|
|   | Used to warn of the risk of electric shock under specific conditions.  |
|   | Used to warn of the risk of minor injury caused by high temperatures.  |
|   | Used for general mandatory action precautions for which there is no specified symbol.  |
|  | Use to indicate prohibition when there is a risk of minor injury from electrical shock or other source if the product is disassembled. |

### ! CAUTION

Minor electric shock, fire, or Product failure may occasionally occur. Do not disassemble, modify, or repair the Product or touch the interior of the Product.



Minor burns may occasionally occur. Do not touch the Product while power is being supplied or immediately after power is turned OFF.



Fire may occasionally occur. Tighten terminal screws to the specified torque (0.5 to 0.6 N·m).



Minor injury due to electric shock may occasionally occur. Do not touch the terminals while power is being supplied. Always close the terminal cover after wiring.



Minor electric shock, fire, or Product failure may occasionally occur. Do not allow any pieces of metal or conductors or any clippings or cuttings resulting from installation work to enter the Product.



## Precautions for Safe Use

### Wiring

- Connect the ground completely. A protective earthing terminal stipulated in safety standards is used. Electric shock or malfunction may occur if the ground is not connected completely.
- Minor fire may possibly occur. Ensure that input and output terminals are wired correctly.
- Do not apply more than 75-N force to the terminal block when tightening it.
- Be sure to remove the sheet covering the Product for machining before power-ON so that it does not interfere with heat dissipation.
- Use the following material for the wires to be connected to the S8VK-G to prevent smoking or ignition caused by abnormal loads.

### Recommended Wire Type/Cross-sectional Area and Stripping Length

| Model       | INPUT               |   | OUTPUT              |   | PE                  |  | Wire Stripping Length |
|-------------|---------------------|---|---------------------|---|---------------------|--|-----------------------|
|             | American Wire Gauge | Solid Wire /Stranded Wire                                 | American Wire Gauge | Solid Wire /Stranded Wire                                 | American Wire Gauge | Solid Wire /Stranded Wire                              |                       |
| S8VK-G01505 | AWG24 to 12         | 0.25 to 4 mm <sup>2</sup><br>/0.25 to 2.5 mm <sup>2</sup> | AWG20 to 12         | 0.5 to 4 mm <sup>2</sup><br>/0.5 to 2.5 mm <sup>2</sup>   | AWG14 to 12         | 2.5 to 4 mm <sup>2</sup> /<br>2.5 to 4 mm <sup>2</sup> | 8 to 10 mm            |
| S8VK-G01512 |                     |   | AWG22 to 12         | 0.35 to 4 mm <sup>2</sup><br>/0.35 to 2.5 mm <sup>2</sup> |                     |  |                       |
| S8VK-G01524 |                     |   | AWG24 to 12         | 0.25 to 4 mm <sup>2</sup><br>/0.25 to 2.5 mm <sup>2</sup> |                     |  |                       |
| S8VK-G03005 | AWG24 to 12         | 0.25 to 4 mm <sup>2</sup><br>/0.25 to 2.5 mm <sup>2</sup> | AWG18 to 12         | 0.75 to 4 mm <sup>2</sup><br>/0.75 to 2.5 mm <sup>2</sup> |                     |  |                       |
| S8VK-G03012 |                     |   | AWG20 to 12         | 0.5 to 4 mm <sup>2</sup><br>/0.5 to 2.5 mm <sup>2</sup>   |                     |  |                       |
| S8VK-G03024 |                     |   | AWG22 to 12         | 0.35 to 4 mm <sup>2</sup><br>/0.35 to 2.5 mm <sup>2</sup> |                     |  |                       |
| S8VK-G06012 | AWG22 to 12         | 0.35 to 4 mm <sup>2</sup><br>/0.35 to 2.5 mm <sup>2</sup> | AWG18 to 12         | 0.75 to 4 mm <sup>2</sup><br>/0.75 to 2.5 mm <sup>2</sup> |                     |  |                       |
| S8VK-G06024 |                     |   | AWG20 to 12         | 0.5 to 4 mm <sup>2</sup><br>/0.5 to 2.5 mm <sup>2</sup>   |                     |  |                       |
| S8VK-G12024 | AWG22 to 10         | 0.35 to 6 mm <sup>2</sup><br>/0.35 to 4 mm <sup>2</sup>   | AWG18 to 10         | 0.75 to 6 mm <sup>2</sup><br>/0.75 to 4 mm <sup>2</sup>   |                     |  |                       |
| S8VK-G24024 | AWG20 to 10         | 0.5 to 6 mm <sup>2</sup><br>/0.5 to 4 mm <sup>2</sup>     | AWG14 to 10         | 2.5 to 6 mm <sup>2</sup><br>/2.5 to 4 mm <sup>2</sup>     |                     |  |                       |
| S8VK-G24048 |                     |   | AWG18 to 10         | 0.75 to 6 mm <sup>2</sup><br>/0.75 to 4 mm <sup>2</sup>   |                     |  |                       |
| S8VK-G48024 | AWG16 to 10         | 1.5 to 6 mm <sup>2</sup><br>/1.5 to 4 mm <sup>2</sup>     | AWG12 to 10         | 4 to 6 mm <sup>2</sup><br>/4 mm <sup>2</sup>              |                     |  |                       |
| S8VK-G48048 |                     |   | AWG14 to 10         | 2.5 to 6 mm <sup>2</sup><br>/2.5 to 4 mm <sup>2</sup>     |                     |  |                       |

- The wire insertion hole, and applicable screwdriver of the terminal block are as follows.

| Model       | Wire Insertion Hole<br>(Refer to the diagram on the right) |     | Applicable Screwdriver |                 |             |
|-------------|--|-----|------------------------|-----------------|-------------|
|             | W  | L   | No.                    | Driver Diameter | Length      |
| S8VK-G01505 | 2.7  | 2.9 | #1                     | 3.5 mm max.     | 4.5 mm min. |
| S8VK-G01512 |  |     |                        |                 |             |
| S8VK-G01524 |  |     |                        |                 |             |
| S8VK-G03005 |  |     |                        |                 |             |
| S8VK-G03012 |  |     |                        |                 |             |
| S8VK-G03024 |  |     |                        |                 |             |
| S8VK-G06012 |  |     |                        |                 |             |
| S8VK-G06024 | 2.9  |     | #2                     | 4.9 mm max.     | 10 mm min.  |
| S8VK-G12024 |  |     |                        |                 |             |
| S8VK-G24024 |  |     |                        |                 |             |
| S8VK-G24048 |  |     |                        |                 |             |
| S8VK-G48024 |  |     |                        |                 |             |
| S8VK-G48048 |  |     |                        |                 |             |



## Installation Environment

- Do not use the Power Supply in locations subject to shocks or vibrations. In particular, install the Power Supply as far away as possible from contactors or other devices that are a vibration source. For usage onboard a ship, always attach an End Plate (PFP-M) to both sides of the Power Supply to hold the Power Supply in place.
- Install the Power Supply well away from any sources of strong, high-frequency noise and surge.

## Operating Life

- The life of a Power Supply is determined by the life of the electrolytic capacitors used inside. Here, Arrhenius Law applies, i.e., the life will be cut in half for each rise of 10°C or the life will be doubled for each drop of 10°C. The life of the Power Supply can thus be increased by reducing its internal temperature.

## Ambient Operating and Storage Environments

- Store the Power Supply at a temperature of -40 to 85°C and a humidity of 0% to 95%.
- Do not use the Power Supply in areas outside the derating curve otherwise, internal parts may occasionally deteriorate or be damaged.
- Use the Power Supply at a humidity of 0% to 95%.
- Do not use the Power Supply in locations subject to direct sunlight.
- Do not use the Power Supply in locations where liquids, foreign matter, or corrosive gases may enter the interior of Products. Models with conformal coated internal parts (S8VK-G\_400) are protected against airborne contaminants in the ambient air. S8VK products use HUMI SEAL 1A27NS Silicone coating.

## Mounting

- Take adequate measures to ensure proper heat dissipation to increase the long-term reliability of the Product. Be sure to allow convection in the atmosphere around devices when mounting. Do not use in locations where the ambient temperature exceeds the range of the derating curve.
- When cutting out holes for mounting, make sure that cuttings do not enter the interior of the Products.

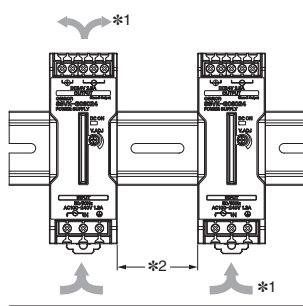

- \*1. Convection of air
- \*2. 20 mm min.

- Improper mounting will interfere with heat dissipation and may occasionally result in deterioration or damage of internal parts. Use the Product within the derating curve for the mounting direction that is used.
- Use a mounting bracket when the Product is mounted facing horizontally.
- Heat dissipation will be adversely affected. When the Product is mounted facing horizontally, always place the side with the label facing upward.

## DIN Rail Mounting

To mount the Block on a DIN Rail, hook portion (A) of the Block onto the rail and press the Block in direction (B).

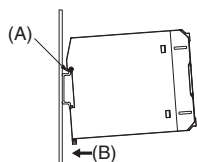

To dismantle the Block, pull down portion (C) with a flat-blade screwdriver and pull out the Block.

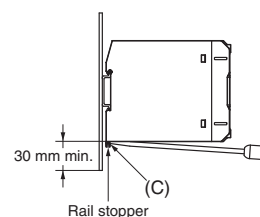

## Power Boost Function

### For All Models

Power Boost is a function that can output the temporary repeated boost current larger than the rated current.

However, it should meet the following four Boost current conditions.

- Time that the boost current flows:  $t_1$
- The maximum value of the boost current:  $I_p$
- The average output current:  $I_{ave}$
- The time ratio of the boost current flow: Duty

**Note:** Boost current conditions

- $t_1 \leq 10$  s
- $I_p \leq$  Rated boost current
- $I_{ave} \leq$  Rated current

$$\text{Duty} = \frac{t_1}{t_1 + t_2} \times 100 [\%] \leq 30\%$$

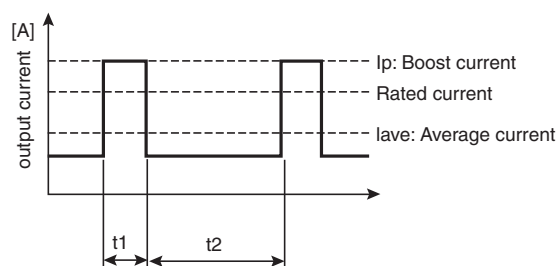

- Do not allow the boost current to continue for more than 10 seconds. Also, do not let the duty cycle exceed the boost current conditions. These conditions may damage the Power supply.
- Ensure that the average current of one cycle of the boost current does not exceed the rated output current. This may damage the Power Supply.
- Lessen the load of the boost load current by adjusting the ambient temperature and the mounting direction.

## Overcurrent Protection

- Internal parts may possibly deteriorate or be damaged if a short-circuited or overcurrent state continues during operation.
- Internal parts may possibly deteriorate or be damaged if the Power Supply is used for applications with frequent inrush current or overloading at the load end. Do not use the Power Supply for such applications.
- The DC ON indicator (green) flashes if the overload protection function operates.

## Charging a Battery

If you connect a battery as the load, install overcurrent control and overvoltage protection circuits.

## Output Voltage Adjuster (V.ADJ)

- The output voltage adjuster (V.ADJ) may possibly be damaged if it is turned with unnecessary force. Do not turn the adjuster with excessive force.
- After completing output voltage adjustment, be sure that the output capacity or output current does not exceed the rated output capacity or rated output current.

## Series Operation

Two power supplies can be connected in series.

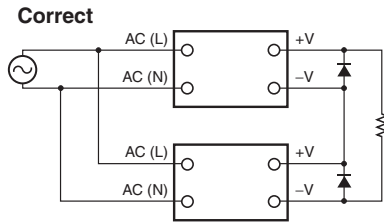

**Note: 1.** The diode is connected as shown in the figure. If the load is short-circuited, a reverse voltage will be generated inside the Power Supply. If this occurs the Power Supply may possibly deteriorate or be damaged. Always connect a diode as shown in the figure. Select a diode having the following ratings.

| Type                       | Schottky Barrier diode                  |
|----------------------------|---|
| Dielectric strength (VRRM) | Twice the rated output voltage or above |
| Forward current (IF)       | Twice the rated output current or above |

**2.** Although Products having different specifications can be connected in series, the current flowing through the load must not exceed the smaller rated output current.

## Making Positive/Negative Outputs

- The outputs are floating outputs (i.e., the primary circuits and secondary circuits are separated). You can therefore make positive and negative outputs by using two Power Supplies. You can make positive and negative outputs with any of the models.

If positive and negative outputs are used, connect Power Supplies of the same model as in the following figure. (Combinations with different output capacities or output voltages can be made. However, use the lower of the two maximum rated output currents as the current to the loads.)

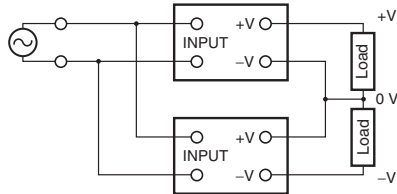

- Depending on the model, internal circuits may be damaged due to startup failure when the power is turned ON if loads such as a servomotor or operational amplifier may operate in series. Therefore, connect bypass diodes (D1, D2) as shown in the following figure.

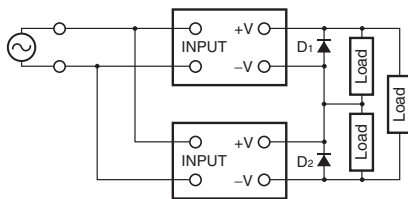

- Use the following information as a guide to the diode type, dielectric strength, and current.

| Type                       | Schottky Barrier diode                  |
|----------------------------|---|
| Dielectric strength (VRRM) | Twice the rated output voltage or above |
| Forward current (IF)       | Twice the rated output current or above |

## Parallel Operation

Parallel operation is used when the output current from one Power Supply is insufficient for the load. Power Supplies are connected in parallel to increase the output current.

The parallel operation of S8VK-G is possible to increase the output power.

However please consider the following notes when the parallel operation must be done.

- The range of ambient temperature for Parallel operation is  $-25$  to  $40^{\circ}\text{C}$ .
- Up to two of the same model can be connected in parallel.
- Adjust the output voltage difference of each Power Supply to 50 mV or less, using the output voltage adjuster (V. ADJ).
- There is no current balancing function for S8VK-G. A high output voltage unit may work at overcurrent state and in this situation, a life of a Power Supply will be extremely short. After adjusting the output voltage, confirm the output current of the two Power Supplies balances.
- Using the parallel operation will not satisfy UL1310 Class2 output.
- For Parallel Operation, to balance the current of the each unit, the length and thickness of each wire connected to the load and each unit must be same as much as possible.
- If you use the 15-W to 240-W S8VK-G in parallel operation, the output voltage may drop by several volts if the load changes rapidly (e.g., if the load starts or is disconnected). If operation becomes unstable, use the S8VK-R as shown in the diagram. Refer to the S8VK-R datasheet (Catalog No.: T059) for S8VK-R specifications and the model number for each capacity.

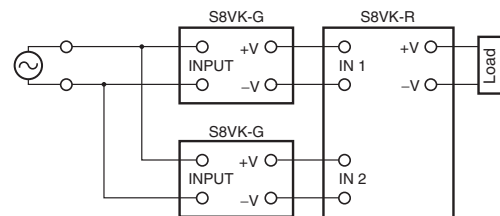

- If you use the 480-W S8VK-G in parallel operation, the output voltage may drop by several volts if the load changes rapidly (e.g., if the load starts or is disconnected). If operation becomes unstable, connect a diode as shown in the diagram.

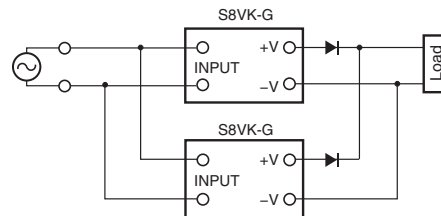

- Use the following information as a guide to the diode type, dielectric strength, and current.

| Type                       | Schottky Barrier diode                  |
|----------------------------|---|
| Dielectric strength (VRRM) | Twice the rated output voltage or above |
| Forward current (IF)       | Twice the rated output current or above |

## Backup Operation

Backup operation is possible if you use two Power Supplies of the same model.

Even if one Power Supply fails, operation can be continued with the other Power Supply.

Make sure that the maximum load does not exceed the capacity of one Power Supply.

For backup operation, connect the S8VK-R as shown in the figure.

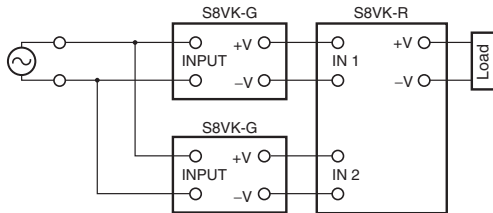

Refer to the S8VK-R datasheet (Catalog No.: T059) for S8VK-R specifications and the model number for each capacity.

## In Case There Is No Output Voltage

The possible cause for no output voltage may be that the overcurrent or overvoltage protection has operated. The internal protection may operate if a large amount of surge voltage such as a lightning surge occurs while turning ON the power supply.

In case there is no output voltage, please check the following points before contacting us:

- Checking overload protected status:  
Check whether the load is in overload status or is short-circuited.  
Remove wires to load when checking.
- Checking overvoltage or internal protection:  
Turn the power supply OFF once, and leave it OFF for at least 3 minutes. Then turn it ON again to see if this clears the condition.

## Audible Noise at Power ON (120-W, 240-W, and 480-W Models)

A harmonic current suppression circuit is built into the Power Supply. This circuit can create noise when the input is turned ON, but it will last only until the internal circuits stabilize and does not indicate any problem in the Product.

## Period and Terms of Warranty

### Warranty Period

The product warranty is valid for a period of five (5) years from the date of shipment from the factory.

### Terms of Warranty

The warranty is valid only for the following operating conditions.

1. Average ambient operating temperature of the product: 40°C max.
2. Average load rate: 80% max.

3. Mounting method: Standard mounting

\* The maximum ratings must be within the derating curve.

If the product fails for reasons attributable to OMRON within the above warranty period, OMRON will repair or replace the faulty part of the product at the place of purchase or the place where the product delivered without charge.

This warranty does not cover the following types of failures.

- (1) Failures that result from handling or operation of the product under conditions or in environments that are not given in this document and not given in any other specifications exchanged between OMRON and the customer
  - (2) Failures that originate in causes other than the delivered product itself
  - (3) Failures caused by disassembly, modification, or repair of the product by anyone other than OMRON
  - (4) Failures caused by applications or uses for which the product was not originally intended
  - (5) Failures caused by factors that could not be anticipated with the scientific or technical knowledge available when the product was shipped
  - (6) Failures caused by other causes for which OMRON is not responsible, such as natural disasters and other acts of God
- This warranty is limited to the individual product that was delivered and does not cover any secondary, subsequent, or related damages.

## Recommended Replacement Periods and Periodic Replacement for Preventive Maintenance

The recommended replacement period for preventive maintenance is greatly influenced by the application environment of the product. As a guideline, the recommended replacement period is 7 to 10 years.\*

To prevent failures or accidents that can be caused by using a product beyond its service life, we recommend that you replace the product as early as possible within the recommended replacement period. However, bear in mind that the recommended replacement period is for reference only and does not guarantee the life of the product.

Many electronic components are used in the product and the product depends on the correct operation of these components to achieve the original product functions and performance.

However, the influence of the ambient temperature on aluminum electrolytic capacitors is large, and the service life is reduced by half for each 10°C rise in temperature (Arrhenius law).

When the capacity reduction life of the electrolytic capacitor is reached, the product failures or accidents may occur.

We therefore recommend that you replace the product periodically to minimize product failures or accidents in advance.

\* The recommended replacement period applies under the following conditions: rated input voltage, load rate of 50% max., ambient temperature of 40°C max., and the standard mounting method.

This product model is designed with a service life of 10 years minimum under the above conditions.



# Terms and Conditions of Sale

1. **Offer; Acceptance.** These terms and conditions (these "**Terms**") are deemed part of all quotes, agreements, purchase orders, acknowledgments, price lists, catalogs, manuals, brochures and other documents, whether electronic or in writing, relating to the sale of products or services (collectively, the "**Products**") by Omron Electronics LLC and its subsidiary companies ("**Omron**"). Omron objects to any terms or conditions proposed in Buyer's purchase order or other documents which are inconsistent with, or in addition to, these Terms.
2. **Prices; Payment Terms.** All prices stated are current, subject to change without notice by Omron. Omron reserves the right to increase or decrease prices on any unshipped portions of outstanding orders. Payments for Products are due net 30 days unless otherwise stated in the invoice.
3. **Discounts.** Cash discounts, if any, will apply only on the net amount of invoices sent to Buyer after deducting transportation charges, taxes and duties, and will be allowed only if (i) the invoice is paid according to Omron's payment terms and (ii) Buyer has no past due amounts.
4. **Interest.** Omron, at its option, may charge Buyer 1-1/2% interest per month or the maximum legal rate, whichever is less, on any balance not paid within the stated terms.
5. **Orders.** Omron will accept no order less than \$200 net billing.
6. **Governmental Approvals.** Buyer shall be responsible for, and shall bear all costs involved in, obtaining any government approvals required for the importation or sale of the Products.
7. **Taxes.** All taxes, duties and other governmental charges (other than general real property and income taxes), including any interest or penalties thereon, imposed directly or indirectly on Omron or required to be collected directly or indirectly by Omron for the manufacture, production, sale, delivery, importation, consumption or use of the Products sold hereunder (including customs duties and sales, excise, use, turnover and license taxes) shall be charged to and remitted by Buyer to Omron.
8. **Financial.** If the financial position of Buyer at any time becomes unsatisfactory to Omron, Omron reserves the right to stop shipments or require satisfactory security or payment in advance. If Buyer fails to make payment or otherwise comply with these Terms or any related agreement, Omron may (without liability and in addition to other remedies) cancel any unshipped portion of Products sold hereunder and stop any Products in transit until Buyer pays all amounts, including amounts payable hereunder, whether or not then due, which are owing to it by Buyer. Buyer shall in any event remain liable for all unpaid accounts.
9. **Cancellation; Etc.** Orders are not subject to rescheduling or cancellation unless Buyer indemnifies Omron against all related costs or expenses.
10. **Force Majeure.** Omron shall not be liable for any delay or failure in delivery resulting from causes beyond its control, including earthquakes, fires, floods, strikes or other labor disputes, shortage of labor or materials, accidents to machinery, acts of sabotage, riots, delay in or lack of transportation or the requirements of any government authority.
11. **Shipping; Delivery.** Unless otherwise expressly agreed in writing by Omron:
  - a. Shipments shall be by a carrier selected by Omron; Omron will not drop ship except in "break down" situations.
  - b. Such carrier shall act as the agent of Buyer and delivery to such carrier shall constitute delivery to Buyer;
  - c. All sales and shipments of Products shall be FOB shipping point (unless otherwise stated in writing by Omron), at which point title and risk of loss shall pass from Omron to Buyer; provided that Omron shall retain a security interest in the Products until the full purchase price is paid;
  - d. Delivery and shipping dates are estimates only; and
  - e. Omron will package Products as it deems proper for protection against normal handling and extra charges apply to special conditions.
12. **Claims.** Any claim by Buyer against Omron for shortage or damage to the Products occurring before delivery to the carrier must be presented in writing to Omron within 30 days of receipt of shipment and include the original transportation bill signed by the carrier noting that the carrier received the Products from Omron in the condition claimed.
13. **Warranties.** (a) **Exclusive Warranty.** Omron's exclusive warranty is that the Products will be free from defects in materials and workmanship for a period of twelve months from the date of sale by Omron (or such other period expressed in writing by Omron). Omron disclaims all other warranties, express or implied. (b) **Limitations.** OMRON MAKES NO WARRANTY OR REPRESENTATION, EXPRESS OR IMPLIED, ABOUT NON-INFRINGEMENT, MERCHANTABILITY OR FITNESS FOR A PARTICULAR PURPOSE OF THE PRODUCTS. BUYER ACKNOWLEDGES THAT IT ALONE HAS DETERMINED THAT THE PRODUCTS WILL SUITABLY MEET THE REQUIREMENTS OF THEIR INTENDED USE. Omron further disclaims all warranties and responsibility of any type for claims or expenses based on infringement by the Products or otherwise of any intellectual property right. (c) **Buyer Remedy.** Omron's sole obligation hereunder shall be, at Omron's election, to (i) replace (in the form originally shipped with Buyer responsible for labor charges for removal or replacement thereof) the non-complying Product, (ii) repair the non-complying Product, or (iii) repay or credit Buyer an amount equal to the purchase price of the non-complying Product; provided that in no event shall Omron be responsible for warranty, repair, indemnity or any other claims or expenses regarding the Products unless Omron's analysis confirms that the Products were properly handled, stored, installed and maintained and not subject to contamination, abuse, misuse or inappropriate modification. Return of any Products by Buyer must be approved in writing by Omron before shipment. Omron Companies shall not be liable for the suitability or unsuitability or the results from the use of Products in combination with any electrical or electronic components, circuits, system assemblies or any other materials or substances or environments. Any advice, recommendations or information given orally or in writing, are not to be construed as an amendment or addition to the above warranty. See <http://www.omron247.com> or contact your Omron representative for published information.
14. **Limitation on Liability; Etc.** OMRON COMPANIES SHALL NOT BE LIABLE FOR SPECIAL, INDIRECT, INCIDENTAL, OR CONSEQUENTIAL DAMAGES, LOSS OF PROFITS OR PRODUCTION OR COMMERCIAL LOSS IN ANY WAY CONNECTED WITH THE PRODUCTS, WHETHER SUCH CLAIM IS BASED IN CONTRACT, WARRANTY, NEGLIGENCE OR STRICT LIABILITY. Further, in no event shall liability of Omron Companies exceed the individual price of the Product on which liability is asserted.
15. **Indemnities.** Buyer shall indemnify and hold harmless Omron Companies and their employees from and against all liabilities, losses, claims, costs and expenses (including attorney's fees and expenses) related to any claim, investigation, litigation or proceeding (whether or not Omron is a party) which arises or is alleged to arise from Buyer's acts or omissions under these Terms or in any way with respect to the Products. Without limiting the foregoing, Buyer (at its own expense) shall indemnify and hold harmless Omron and defend or settle any action brought against such Companies to the extent based on a claim that any Product made to Buyer specifications infringed intellectual property rights of another party.
16. **Property; Confidentiality.** Any intellectual property in the Products is the exclusive property of Omron Companies and Buyer shall not attempt to duplicate it in any way without the written permission of Omron. Notwithstanding any charges to Buyer for engineering or tooling, all engineering and tooling shall remain the exclusive property of Omron. All information and materials supplied by Omron to Buyer relating to the Products are confidential and proprietary, and Buyer shall limit distribution thereof to its trusted employees and strictly prevent disclosure to any third party.
17. **Export Controls.** Buyer shall comply with all applicable laws, regulations and licenses regarding (i) export of products or information; (ii) sale of products to "forbidden" or other proscribed persons; and (iii) disclosure to non-citizens of regulated technology or information.
18. **Miscellaneous.** (a) **Waiver.** No failure or delay by Omron in exercising any right and no course of dealing between Buyer and Omron shall operate as a waiver of rights by Omron. (b) **Assignment.** Buyer may not assign its rights hereunder without Omron's written consent. (c) **Law.** These Terms are governed by the law of the jurisdiction of the home office of the Omron company from which Buyer is purchasing the Products (without regard to conflict of law principles). (d) **Amendment.** These Terms constitute the entire agreement between Buyer and Omron relating to the Products, and no provision may be changed or waived unless in writing signed by the parties. (e) **Severability.** If any provision hereof is rendered ineffective or invalid, such provision shall not invalidate any other provision. (f) **Setoff.** Buyer shall have no right to set off any amounts against the amount owing in respect of this invoice. (g) **Definitions.** As used herein, "including" means "including without limitation"; and "Omron Companies" (or similar words) mean Omron Corporation and any direct or indirect subsidiary or affiliate thereof.

## Certain Precautions on Specifications and Use

1. **Suitability of Use.** Omron Companies shall not be responsible for conformity with any standards, codes or regulations which apply to the combination of the Product in the Buyer's application or use of the Product. At Buyer's request, Omron will provide applicable third party certification documents identifying ratings and limitations of use which apply to the Product. This information by itself is not sufficient for a complete determination of the suitability of the Product in combination with the end product, machine, system, or other application or use. Buyer shall be solely responsible for determining appropriateness of the particular Product with respect to Buyer's application, product or system. Buyer shall take application responsibility in all cases but the following is a non-exhaustive list of applications for which particular attention must be given: (i) Outdoor use, uses involving potential chemical contamination or electrical interference, or conditions or uses not described in this document. (ii) Use in consumer products or any use in significant quantities. (iii) Energy control systems, combustion systems, railroad systems, aviation systems, medical equipment, amusement machines, vehicles, safety equipment, and installations subject to separate industry or government regulations. (iv) Systems, machines and equipment that could present a risk to life or property. Please know and observe all prohibitions of use applicable to this Product. NEVER USE THE PRODUCT FOR AN APPLICATION INVOLVING SERIOUS RISK TO LIFE OR PROPERTY OR IN LARGE QUANTITIES WITHOUT ENSURING THAT THE SYSTEM AS A WHOLE HAS BEEN DESIGNED TO ADDRESS THE RISKS, AND THAT THE OMRON'S PRODUCT IS PROPERLY RATED AND INSTALLED FOR THE INTENDED USE WITHIN THE OVERALL EQUIPMENT OR SYSTEM.
2. **Programmable Products.** Omron Companies shall not be responsible for the user's programming of a programmable Product, or any consequence thereof.
3. **Performance Data.** Data presented in Omron Company websites, catalogs and other materials is provided as a guide for the user in determining suitability and does not constitute a warranty. It may represent the result of Omron's test conditions, and the user must correlate it to actual application requirements. Actual performance is subject to the Omron's Warranty and Limitations of Liability.
4. **Change in Specifications.** Product specifications and accessories may be changed at any time based on improvements and other reasons. It is our practice to change part numbers when published ratings or features are changed, or when significant construction changes are made. However, some specifications of the Product may be changed without any notice. When in doubt, special part numbers may be assigned to fix or establish key specifications for your application. Please consult with your Omron's representative at any time to confirm actual specifications of purchased Product.
5. **Errors and Omissions.** Information presented by Omron Companies has been checked and is believed to be accurate; however, no responsibility is assumed for clerical, typographical or proofreading errors or omissions.

**OMRON AUTOMATION AND SAFETY • THE AMERICAS HEADQUARTERS** • Chicago, IL USA • 847.843.7900 • 800.556.6766 • [www.omron247.com](http://www.omron247.com)

**OMRON CANADA, INC. • HEAD OFFICE**

Toronto, ON, Canada • 416.286.6465 • 866.986.6766 • [www.omron247.com](http://www.omron247.com)

**OMRON ELECTRONICS DE MEXICO • HEAD OFFICE**

México DF • 52.55.59.01.43.00 • 01-800-226-6766 • [mela@omron.com](mailto:mela@omron.com)

**OMRON ELECTRONICS DE MEXICO • SALES OFFICE**

Apodaca, N.L. • 52.81.11.56.99.20 • 01-800-226-6766 • [mela@omron.com](mailto:mela@omron.com)

**OMRON ELETRÔNICA DO BRASIL LTDA • HEAD OFFICE**

São Paulo, SP, Brasil • 55.11.2101.6300 • [www.omron.com.br](http://www.omron.com.br)

**OMRON ARGENTINA • SALES OFFICE**

Cono Sur • 54.11.4783.5300

**OMRON CHILE • SALES OFFICE**

Santiago • 56.9.9917.3920

**OTHER OMRON LATIN AMERICA SALES**

54.11.4783.5300

**OMRON EUROPE B.V.** • Wegalaan 67-69, NL-2132 JD, Hoofddorp, The Netherlands. • +31 (0) 23 568 13 00 • [www.industrial.omron.eu](http://www.industrial.omron.eu)

*Authorized Distributor:*

**Automation Control Systems**

- Machine Automation Controllers (MAC) • Programmable Controllers (PLC)
- Operator interfaces (HMI) • Distributed I/O • Software

**Drives & Motion Controls**

- Servo & AC Drives • Motion Controllers & Encoders

**Temperature & Process Controllers**

- Single and Multi-loop Controllers

**Sensors & Vision**

- Proximity Sensors • Photoelectric Sensors • Fiber-Optic Sensors
- Amplified Photomicrosensors • Measurement Sensors
- Ultrasonic Sensors • Vision Sensors

**Industrial Components**

- RFID/Code Readers • Relays • Pushbuttons & Indicators
- Limit and Basic Switches • Timers • Counters • Metering Devices
- Power Supplies

**Safety**

- Laser Scanners • Safety Mats • Edges and Bumpers • Programmable Safety Controllers • Light Curtains • Safety Relays • Safety Interlock Switches