

DETAILS

Product Number	CP12687_TINA2-RS
Family	Tina
Type	Assembly
Color	black
Diameter	16,1 mm
Height	9,5 mm
Style	round
Optic Material	PMMA
Holder Material	
Fastening	glue
Status	production ready
ROHS Compliant	Yes
Date Updated	4/06/2012



OPTICAL PROPERTIES

LED	Viewing	Light	Effi-	cd/lm	Connector
	Angle	Beam	ciency		
Oslo SSL 80	9 deg	Real spot	88 %	16.000	-
Oslo SSL 150	10 deg	Real spot	90 %	17.800	-
Oslo Square EC	14 deg	Real spot	88 %	10.500	-

D

C

B

A



Isometric view
Scale: 1:1

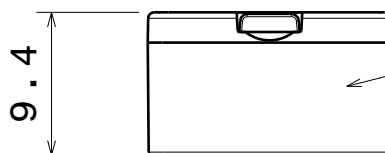
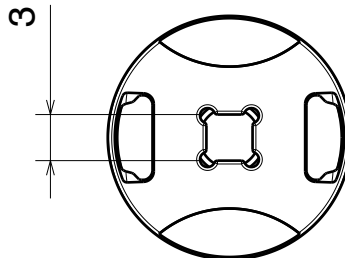

Holder

Lens

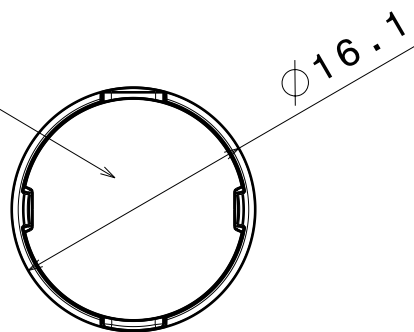

Materials:
Lens PMMA
Holder PC, Black

Tolerances for dimensions:
0-20mm tolerance value $\pm 0.1\text{mm}$
21-45mm tolerance value $\pm 0.2\text{mm}$
46-90mm tolerance value $\pm 0.3\text{mm}$
91-100mm tolerance value $\pm 0.4\text{mm}$
101-mm tolerance value $\pm 0.5\text{mm}$

This drawing is our property.
It can't be reproduced
or communicated without
our written agreement.



Ledil Oy
Salorankatu 10
FIN 24240 SALO
Finland

DRAWING TITLE

Datasheet Tina2 OSL Glue Assy

DRAWN BY

pv

DATE

11.04.2012

CHECKED BY

sn

DATE

12.03.2012

DESIGNED BY

pv

DATE

12.03.2012

SIZE

A4

DRAWING NUMBER

-

REV

1

SCALE

2:1

WEIGHT (g)

SHEET

1/1

A

Luminaire: LEDIL OY CP12687_TINA2-RS (SSL80) Efficiency=88%
Lamps: 1 x Osram Oslon SSL 80° (85lm@250mA)

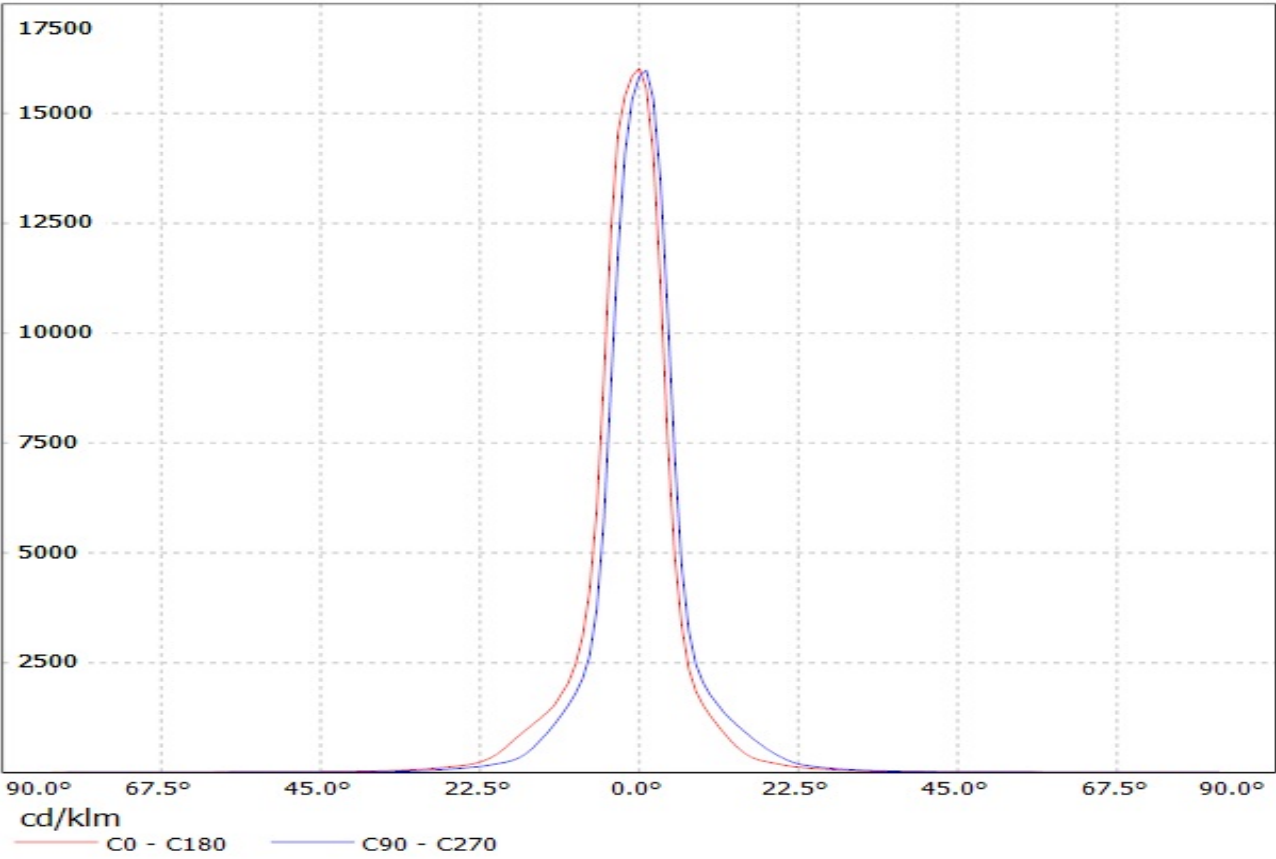

Luminaire: LEDIL OY CP12687_TINA2-RS (SSL150) Efficiency=90%
Lamps: 1 x Osram Oslon SSL 150° (95lm@250mA)

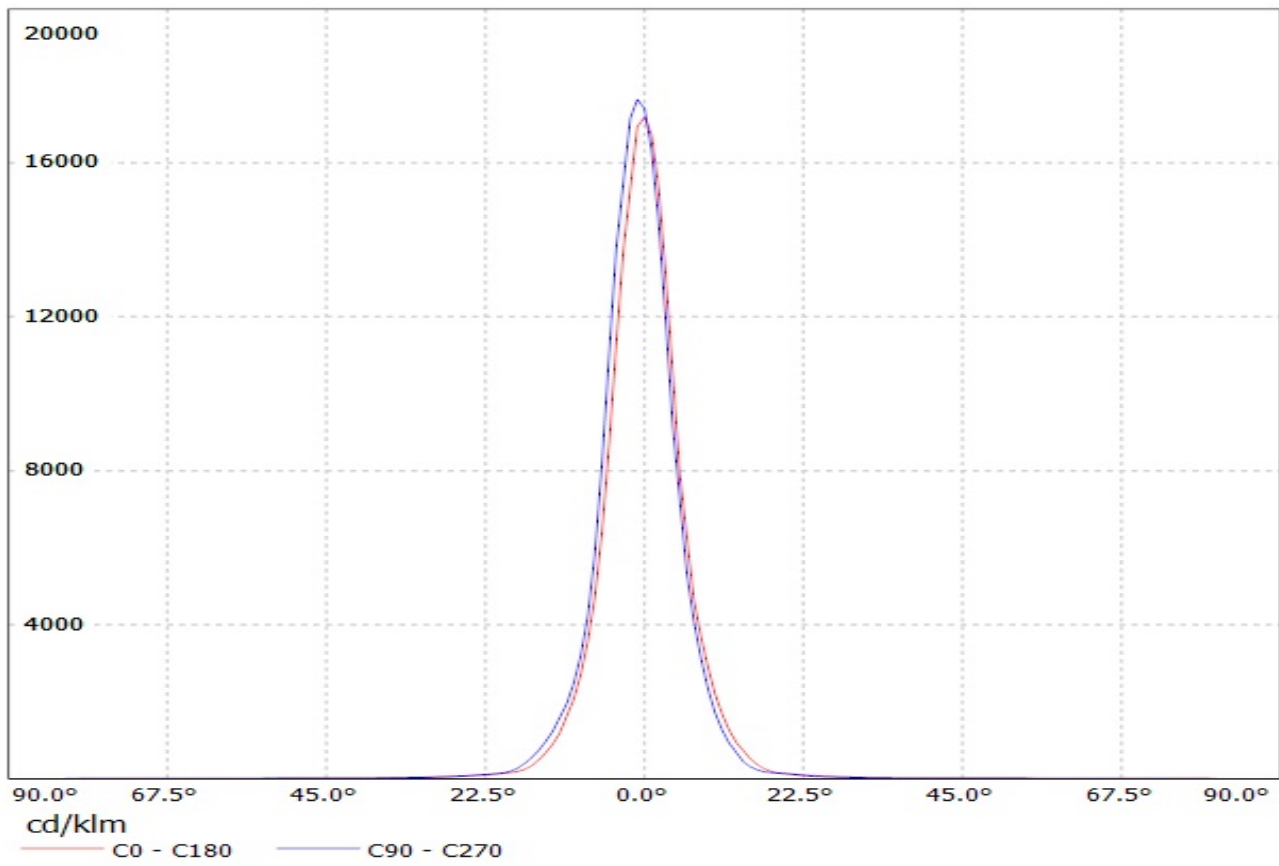

Luminaire: LEDIL OY CP12687_TINA2-RS (Osram Square EC) Efficiency=88%
Lamps: 1 x Osram Oslon Square EC (69lm@250mA)

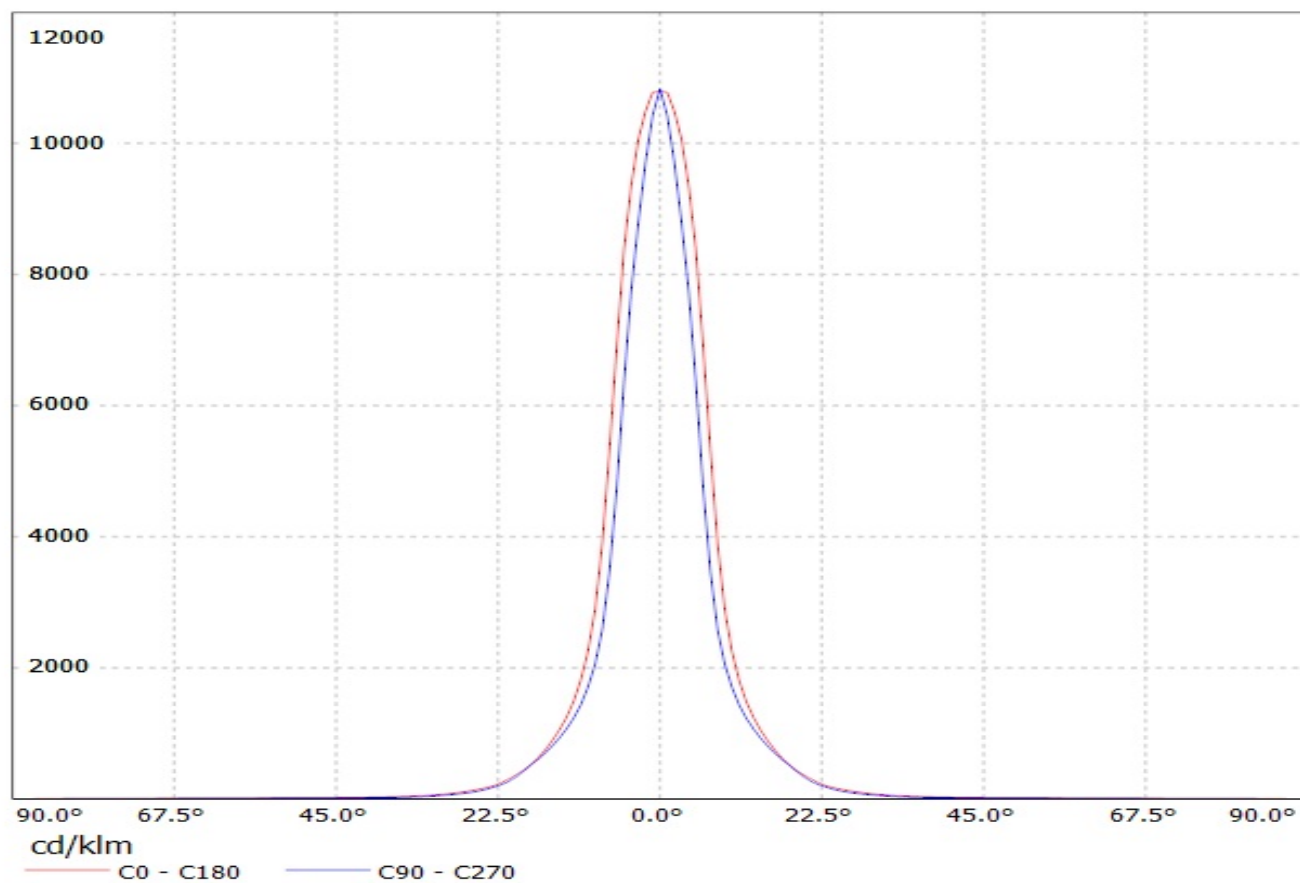

Luminaire: LEDIL OY CP12687_TINA2-RS (SSL80) Efficiency=88%
Lamps: 1 x Osram Oslon SSL 80° (85lm@250mA)

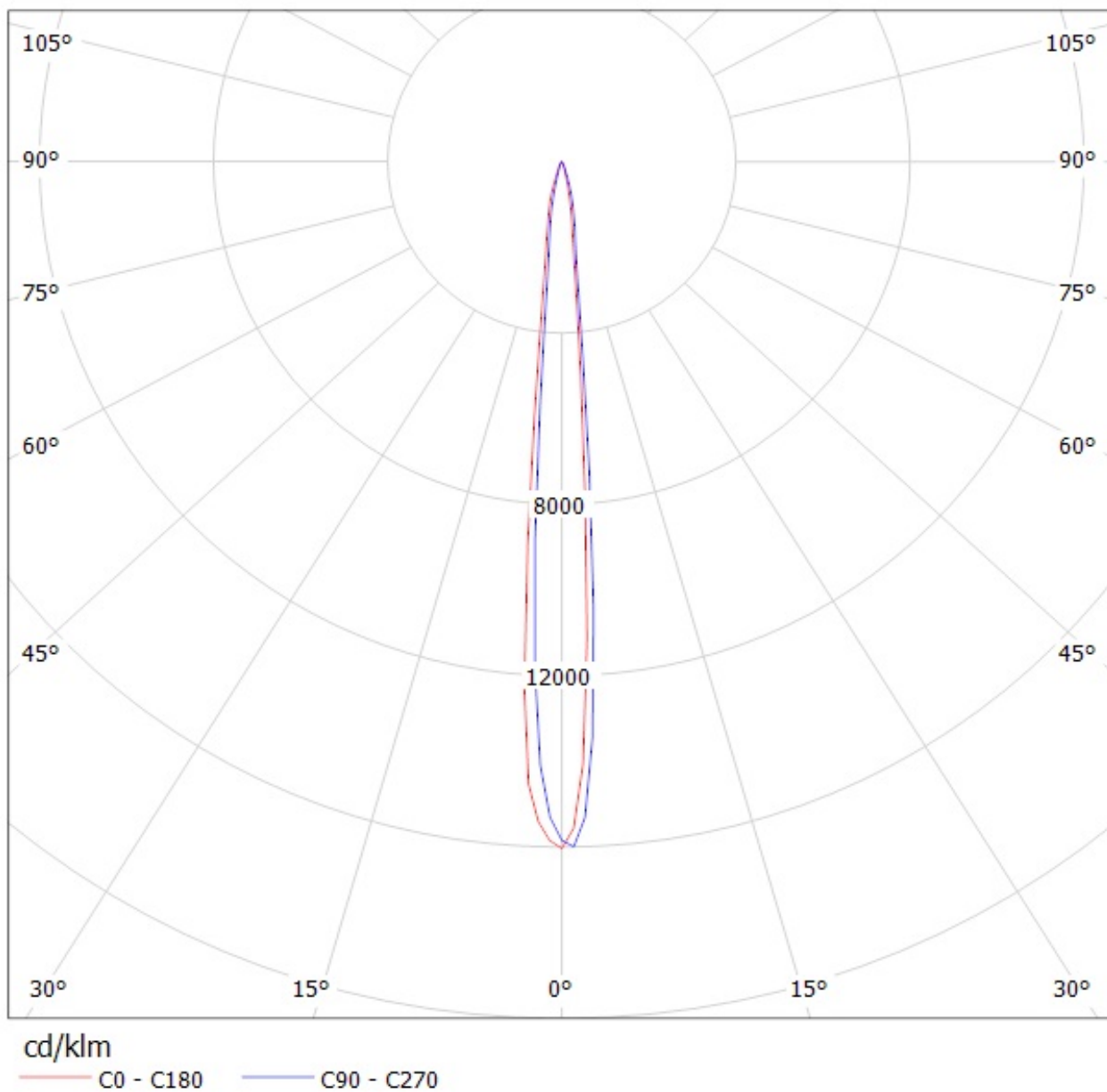

Luminaire: LEDIL OY CP12687_TINA2-RS (SSL150) Efficiency=90%
Lamps: 1 x Osram Oslon SSL 150° (95lm@250mA)

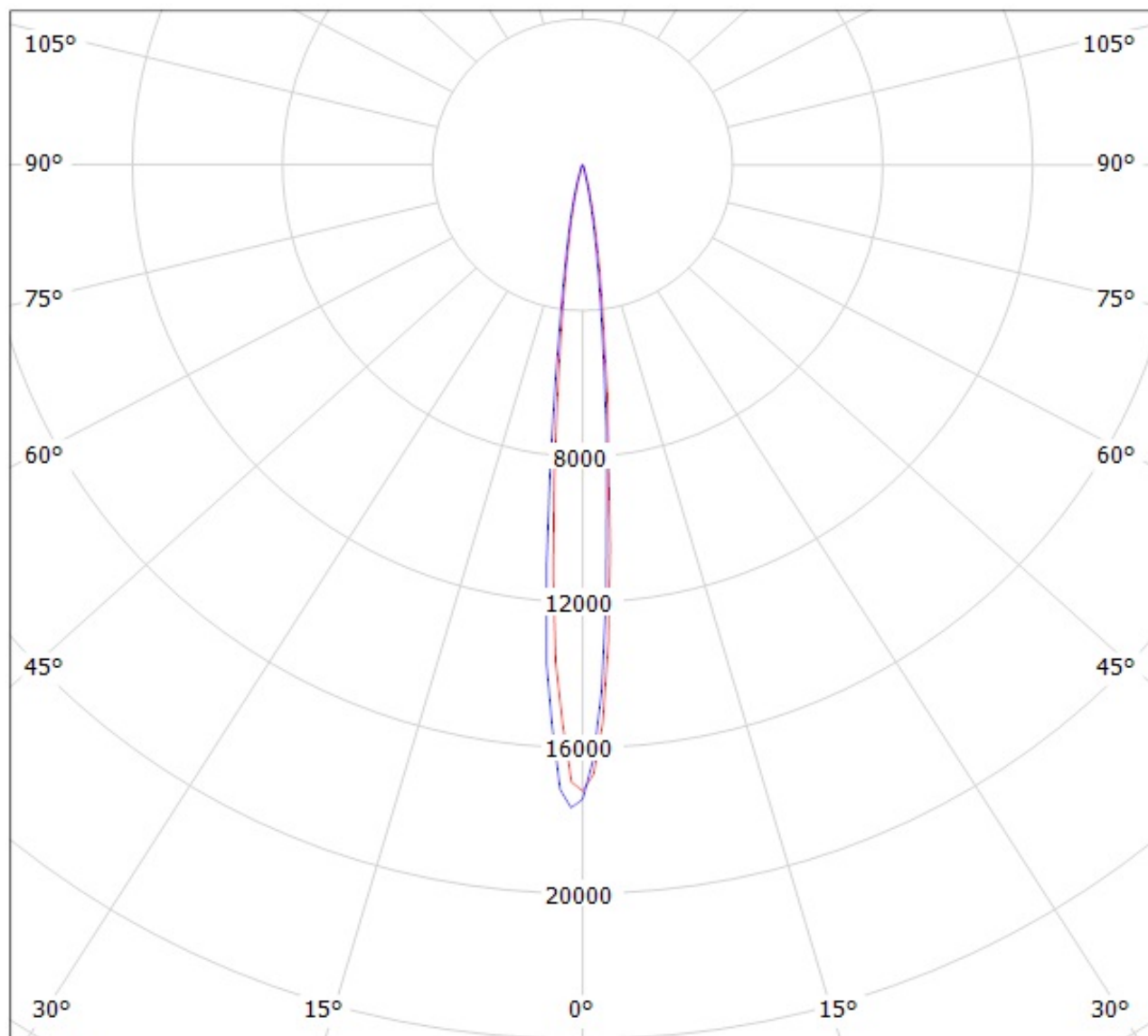

cd/klm

— C0 - C180

— C90 - C270

Luminaire: LEDIL OY CP12687_TINA2-RS (Osram Square EC) Efficiency=88%
Lamps: 1 x Osram Oslon Square EC (69lm@250mA)

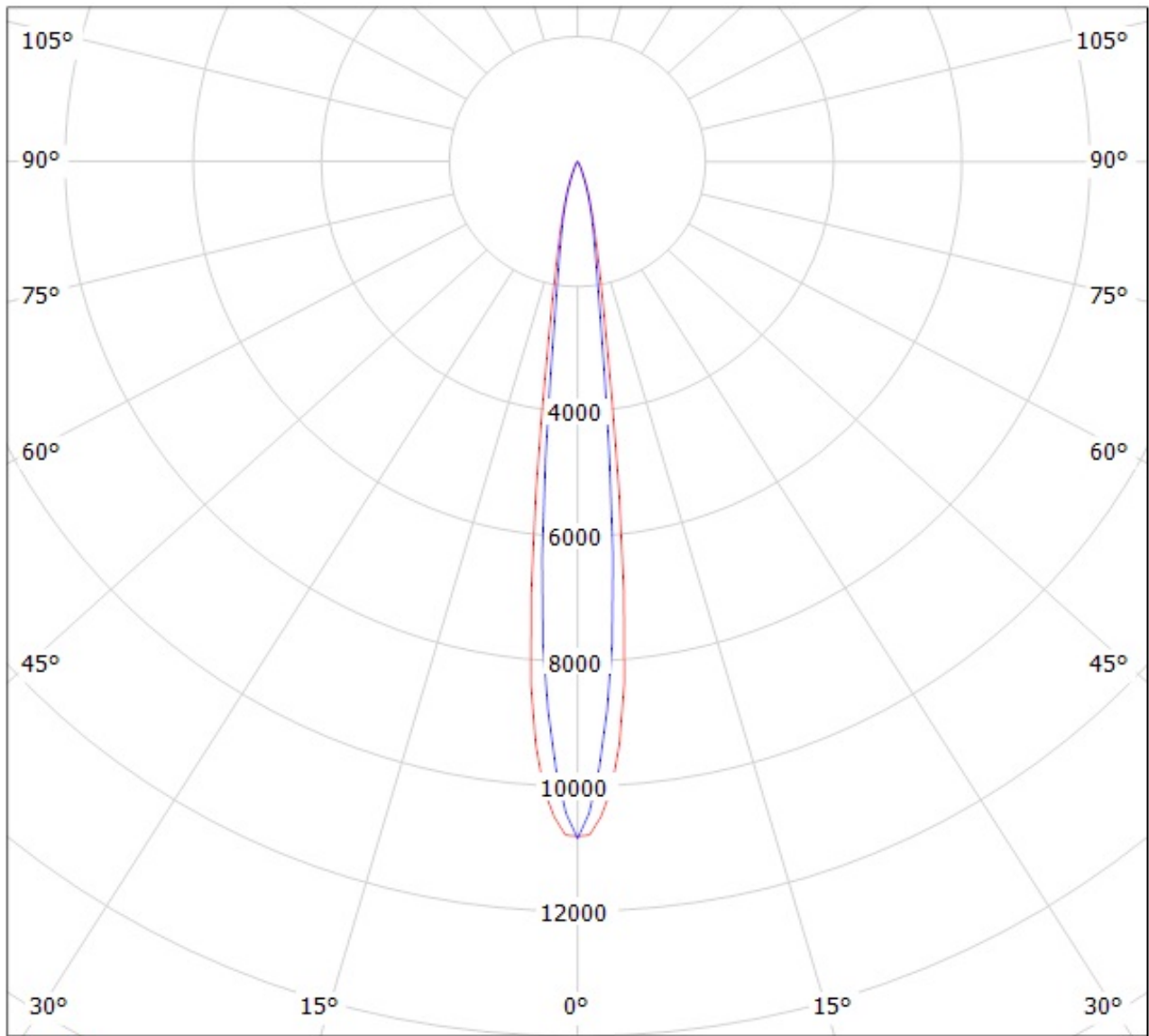

cd/klm

— C0 - C180 — C90 - C270

NOTE: The typical divergence will be changed by different color, chip size and chip position tolerance. The typical total divergence is the full angle measured where the luminous intensity is half of the peak value.